

 **PADGETT**  
INSTRUMENTS® By **Integra™ Miltex®**



PLASTIC SURGERY, ENT & SPECIALTY INSTRUMENTS

589 Davies Drive

York, PA 17402

toll-free phone 866-854-8300

toll-free fax 866-854-8400

phone 717-840-9335

fax 717-840-9347

email [customerservice.miltex@integralife.com](mailto:customerservice.miltex@integralife.com)

[integralife.com/integra-miltex](http://integralife.com/integra-miltex)





## INTRODUCTION

**Padgett Instruments by Integra Miltex is a partnership** of two very respected names in surgical instrumentation. These classic brands provide a combination of choice and quality unmatched by any other instrument company.

The Padgett and Integra Miltex names are synonymous with premium surgical instrumentation manufactured from the highest quality stainless steel by skilled German craftsmen to exacting specifications. The surgical “feel” of our instruments, the superb cutting ability, the smoothly beveled box locks and jaw edges which protect suture material from snags or cutting are just a few features that differentiate and make our products outperform and stand-out from the competition.

This catalog presents a comprehensive offering of premium SuperCut and Tungsten Carbide instruments as well as forceps, rasps, retractors, dissectors, fiber optic and other specialty instrument patterns. Our instrument selection recognizes and meets the variety of clinical needs for all specialties including Plastic Surgery, Dermatology, General Surgery, ENT, Ophthalmology and many more.

### General Information:

Surgical instruments shown in this catalog are made of high quality surgical grade stainless steel, unless otherwise noted.

Illustrations and content provide general description only and may be subject to change.

Some products in this catalog may not be available for sale in the European Union.

Miltex is registered trademark of IntegraYork PA, Inc., a subsidiary of Integra LifeSciences Corporation.

Padgett is a registered trademark of Integra LifeSciences Corporation.

Integra and the Integra logo are trademarks of Integra LifeSciences Corporation.

©2010 Integra LifeSciences Corporation



<b>Bone Instruments</b> .....	1
Chisels .....	2-6
Osteotomes .....	6-11
Gouges .....	11-12
Rongeurs .....	13-15
Bone Cutting Forceps .....	16-17
Curettes .....	18-19
<b>Dissectors and Elevators</b> .....	20
Dissectors .....	21-29
Elevators .....	30-42
<b>Forceps</b> .....	43
Tungsten Carbide .....	44-50
Dressing & Tissue .....	51-71
Microsurgical .....	72-75
Reusable Bipolar .....	76-77
Specialty .....	78-99
Clamps .....	100-101
Ring-Handled and Hemostats .....	102-107
<b>Hooks and Retractors</b> .....	108
Hooks .....	109-118
Retractors .....	118-140
Mouth Gags .....	141-143
Oral Retractors .....	144-146
Specula .....	147-148
<b>Knives and Handles</b> .....	149
Knife Handles .....	150-151
Blades .....	152
Blade Breakers .....	153
Knives - Miscellaneous .....	154-158
Skin Graft Knives .....	159
<b>Mallets and Cartilage Instruments</b> .....	160
Mallets .....	161-163
Cartilage Instruments .....	164
Morselizers .....	165-166
<b>Needle Holders</b> .....	167
Tungsten Carbide .....	168-178
Stainless Steel .....	179-183
<b>Needles, Probes, and Passers</b> .....	184
Needles .....	185-186
Probes .....	187-190
Passers .....	191
<b>Rasps, Files and Saws</b> .....	192
Rasps, Tungsten Carbide .....	193-195
Rasps, Standard .....	196-201
Files .....	202-203
Saws .....	204-205
<b>Scissors</b> .....	206
Ceramic .....	209-213
Supercut/Tungsten Carbide .....	214-217
Supercut .....	218-223
Tungsten Carbide .....	224-234
Standard .....	235-266
<b>Specialty Procedure Instruments</b> .....	267
Nasal Instrumentation .....	268-272
Hand Instrumentation .....	273-277
Dermatology Instrumentation .....	278-280

**Suction** ..... 281-284

**Pin and Wire Instruments** ..... 285

    Tungsten Carbide ..... 286-290

    Pliers ..... 291-297

**Measuring & Marking Instruments** ..... 298

    Measuring Instruments ..... 299-303

    Measuring Breast ..... 304-306

    Measuring Face ..... 307-308

    Measuring Abdominal ..... 309

**Fiber Optic Instruments** ..... 310

    Retractors ..... 311-316

    Accessories ..... 317-318

**Otolaryngology Instruments** ..... 319

    Ear ..... 320-331

    Nasal ..... 332-343

    Oral ..... 344-346

**Disposable Ready-To-Use Products** ..... 347

    Biopsy Punches ..... 348

    BiopBlade™ ..... 349

    Dermal Curettes ..... 349

    Scalpels ..... 350-351

    Surgical Blades ..... 352

    Single-Use Instruments ..... 353

    Ear Curettes ..... 354

    ENT Packing Line ..... 355-357

**Stainless Steelware & Instrument Stringers** ..... 358

    Stainless Steelware ..... 359-361

    Stringers ..... 362

**Instrument Maintenance & Care** ..... 363

    Care & Cleaning Products ..... 364-367

    Sterilization Accessories ..... 368-369

    Cassettes & Mats ..... 370-373

    Stringers ..... 374-375

    Maintenance & Care ..... 376-379

**Suggested Instrument Sets** ..... 383-395

**Reference, Warranty & Repair** ..... 377-382

**Indexes** ..... 396

    Alphabetical Index ..... 396-406

    Numerical Index ..... 407-418

# BONE INSTRUMENTS



Chisels  
Osteotomes  
Gouges  
Rongeurs  
Bone Cutting Forceps  
Curettes

### Brauer Rocking Nasal Chisel

Catalog#	Length	Width
PM-708	6-1/4" (159 mm)	13 mm

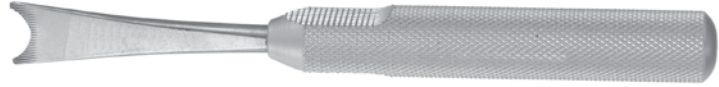

PM-708

### Braithwaite Nasal Chisel

Catalog#	Description	Length	Width
PM-1554A	Right	5-1/2" (140 mm)	5 mm
PM-1554B	Left	5-1/2" (140 mm)	5 mm



PM-1554A

### Silver Cartilage Chisel

Catalog#	Description	Length	Width
21-227*	Straight, Single Guard	7" (178 mm)	7 mm
21-229*	Curved Left, Single Guard	7" (178 mm)	7 mm
21-228*	Curved Right, Single Guard	7-1/4" (184 mm)	7 mm

\*Miltex® Brand



21-228

### Freer Septum Chisel

Catalog#	Description	Length	Width
20-270*	Straight	6-1/2" (165 mm)	4 mm
18-1960*	Curved	6-1/2" (165 mm)	4 mm
PM-4412	Straight	7-1/2" (191 mm)	4 mm
PM-4413	Curved	7-1/2" (191 mm)	4 mm

\*Miltex® Brand

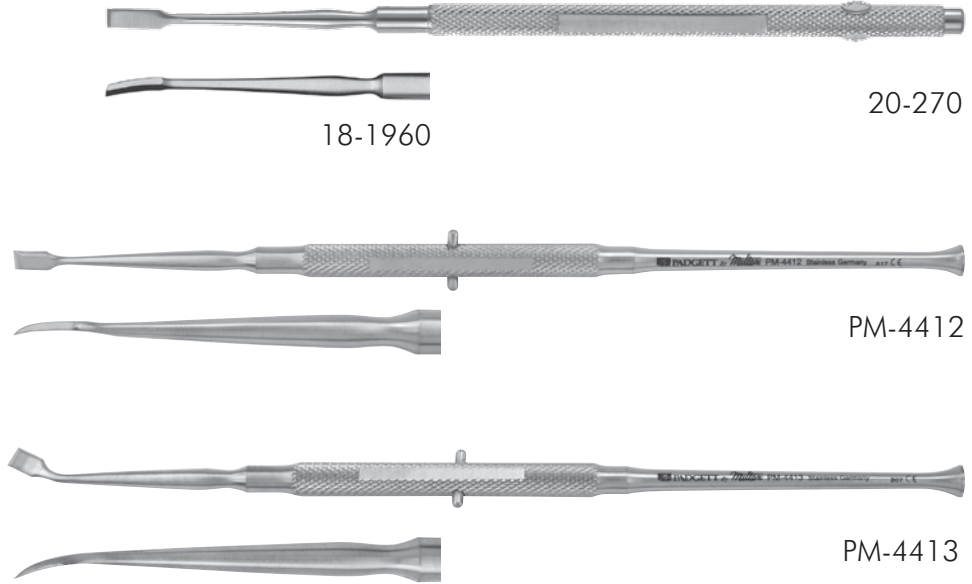

### Fomon Chisel

Catalog#	Description	Length	Width
PM-7500	Guarded Point	6-1/2" (165 mm)	5 mm
PM-7502	Guarded Point	6-1/2" (165 mm)	7 mm
PM-7503	Guarded Point	6-1/2" (165 mm)	8 mm



**Cottle Chisel**

Catalog#	Description	Length	Width
21-206-4*	Rounded Corners	7" (178 mm)	4 mm
21-206-7*	Rounded Corners	7" (178 mm)	7 mm
21-206-9*	Rounded Corners	7" (178 mm)	9 mm
21-206-12*	Rounded Corners	7" (178 mm)	12 mm

\*Miltex® Brand



21-206-4

**Cottle Chisel, with depth graduations in cm**

Catalog#	Description	Length	Width
21-212*	Curved	7-1/4" (184 mm)	5 mm
PM-7530	Curved	7-1/4" (184 mm)	6 mm

\*Miltex® Brand



21-212



PM-7530

**Hajek Septum Chisel**

Catalog#	Description	Length	Width
PM-7570	Small	6-1/4" (159 mm)	4 mm
PM-7572	Medium	6-1/4" (159 mm)	6 mm
PM-7574	Large	6-1/4" (159 mm)	8 mm



PM-7570



Graduated Chisels, (7-10-13-15-18 mm markings)

Catalog#	Description	Length	Width
62-20*	Straight	7" (178 mm)	3.8 mm
62-21*	Curved	7" (178 mm)	3.8 mm
62-22*	Straight	7" (178 mm)	7.5 mm
62-23*	Curved	7" (178 mm)	7.5 mm

\*Miltex® Brand

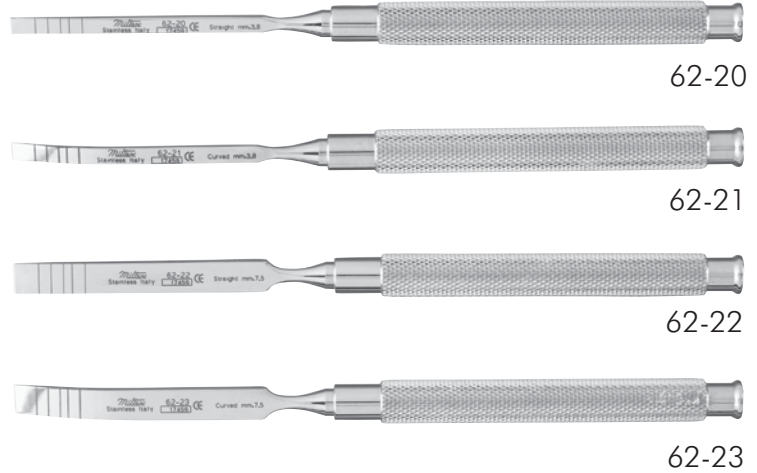

Freer Chisels

Catalog#	Description	Length	Width
62-40*	Single Cut Blade	6-1/2" (165 mm)	2 mm
62-41*	Single Cut Blade	6-1/2" (165 mm)	4 mm
62-42*	Single Cut Blade	6-1/2" (165 mm)	6 mm
62-43*	Double Cut Blade	6-1/2" (165 mm)	2 mm
62-44*	Double Cut Blade	6-1/2" (165 mm)	4 mm
62-45*	Double Cut Blade	6-1/2" (165 mm)	6 mm

\*Miltex® Brand

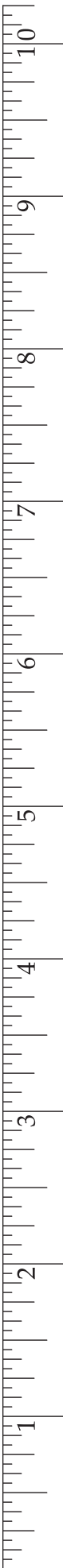
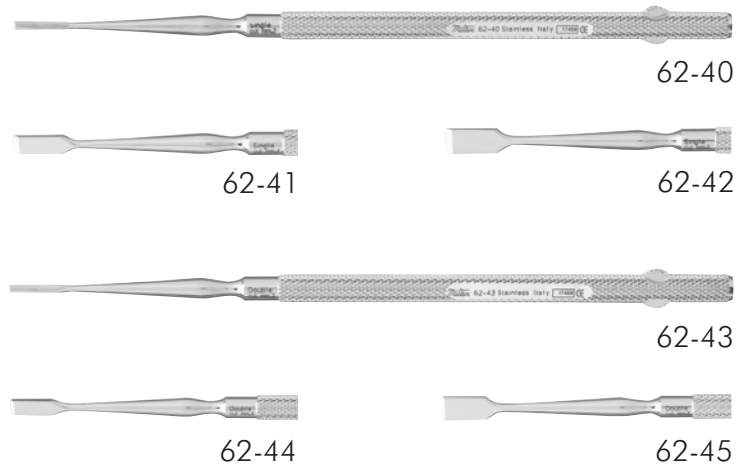

### Clodius Bone Chisel

Catalog#	Length	Width
PM-3813	8-3/4" (222 mm)	6 mm
PM-3814	8-3/4" (222 mm)	8 mm
PM-3815	8-3/4" (222 mm)	10 mm
PM-3817	8-3/4" (222 mm)	16 mm
PM-3818	8-3/4" (222 mm)	20 mm



PM-3814

### Ballenger V-Shaped Chisel

Catalog#	Length	Width
20-278*	6-1/4" (159 mm)	2 mm
20-280*	6-1/4" (159 mm)	4 mm
20-282*	6-1/4" (159 mm)	6 mm
20-284*	6-1/4" (159 mm)	8 mm

\*Miltex® Brand



20-284

### Sheehan Chisel/Osteotome with Hexagon Handle

Catalog#	Length	Width
21-205-2*	6-1/4" (159 mm)	2 mm
21-205-4*	6-1/4" (159 mm)	4 mm
21-205-6*	6-1/4" (159 mm)	6 mm
PM-7600	6-1/4" (159 mm)	7 mm
21-205-8*	6-1/4" (159 mm)	8 mm
21-205-10*	6-1/4" (159 mm)	10 mm
PM-7606	6-1/4" (159 mm)	11 mm
21-205-12*	6-1/4" (159 mm)	12 mm
21-205-15*	6-1/4" (159 mm)	15 mm

\*Miltex® Brand



PM-7600

### Mini-Osteotomes

Catalog#	Description	Length	Width
PM-044402	Straight	5" (127 mm)	2 mm
PM-044404	Straight	5" (127 mm)	4 mm
PM-044406	Straight	5" (127 mm)	6 mm
PM-044408	Straight	5" (127 mm)	8 mm
PM-044410	Straight	5" (127 mm)	10 mm
PM-044412	Straight	5" (127 mm)	12 mm
PM-044422	Curved	5" (127 mm)	2 mm
PM-044424	Curved	5" (127 mm)	4 mm
PM-044426	Curved	5" (127 mm)	6 mm
PM-044428	Curved	5" (127 mm)	8 mm
PM-044430	Curved	5" (127 mm)	10 mm
PM-044432	Curved	5" (127 mm)	12 mm

Ideal for maxillofacial, oral, plastic and reconstructive surgery procedures.

Distal working end serrated for bone compacting and mallet interface control.

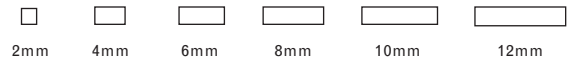

PM-044402

PM-044422

### Ward Nasal Osteotome

Catalog#	Length	Width
PM-1546-3	6-1/2" (165 mm)	3 mm
PM-1546-5	6-1/2" (165 mm)	5 mm



PM-1546-3

### Rees Nasal Osteotome\*

Catalog#	Description	Length	Width
PM-711	Red Handle	7-3/4" (197 mm)	3 mm
PM-712	Green Handle	7-3/4" (197 mm)	4 mm

\*Anodized Aluminum handle with stainless steel working end



PM-711

### Rozner Nasal Osteotome

Catalog#	Length	Width
PM-1520	6-1/2" (165 mm)	6.5 mm



PM-1520

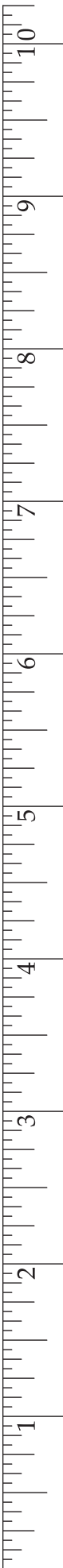

**French Pattern Osteotome**

Catalog#	Length	Width
PM-1502-5	5-3/4" (146 mm)	5 mm
PM-1502-7	5-3/4" (146 mm)	7 mm
PM-1502-9	5-3/4" (146 mm)	9 mm



PM-1502-5

**Lambotte Osteotome**

Catalog#	Length	Width
PM-3800	5" (127 mm)	4 mm
PM-3802	5" (127 mm)	6 mm
PM-3804	5" (127 mm)	8 mm
PM-3806	5" (127 mm)	10 mm
PM-3808	5" (127 mm)	12 mm



PM-3800

**Rish Osteotome**

Catalog#	Description	Length	Width
PM-4982	Single Guarded, Straight	7" (178 mm)	6.5 mm



PM-4982

**Neivert Osteotome**

Catalog#	Description	Length	Width
21-232*	Straight, Single Guarded	8" (203 mm)	5 mm
21-233*	Curved Right, Single Guarded	8" (203 mm)	4 mm
21-234*	Curved Left, Single Guarded	8" (203 mm)	4 mm



\*Miltex® Brand

21-232

### Cinelli Osteotome

Catalog#	Description	Length	Width
PM-4762	Single Guarded	6-1/4" (159 mm)	13 mm



PM-4762

### Cinelli Osteotome

Catalog#	Description	Length	Width
PM-4983	Double Guarded, Curved	6-1/4" (159 mm)	10 mm
21-215*	Double Guarded, Straight	6-1/4" (159 mm)	10 mm
21-216*	Double Guarded, Straight	6-1/4" (159 mm)	12 mm
21-217*	Double Guarded, Straight	6-1/4" (159 mm)	14 mm
21-218*	Double Guarded, Straight	6-1/4" (159 mm)	16 mm

\*Miltex® Brand



21-215

### Padgett Osteotome

Catalog#	Length	Width
PM-4810	7" (178 mm)	2 mm
PM-4811	7" (178 mm)	3 mm
PM-4812	7" (178 mm)	4 mm
PM-4813	7" (178 mm)	5 mm
PM-4814	7" (178 mm)	6 mm
PM-4815	7" (178 mm)	7 mm
PM-4816	7" (178 mm)	8 mm
PM-4817	7" (178 mm)	9 mm
PM-4818	7" (178 mm)	10 mm
PM-4819	7" (178 mm)	11 mm
PM-4820	7" (178 mm)	12 mm
PM-4828	7" (178 mm)	15 mm
PM-4830	Set of 12 Padgett Osteotomes	

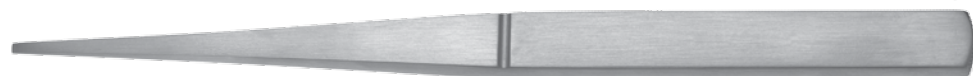

PM-4810

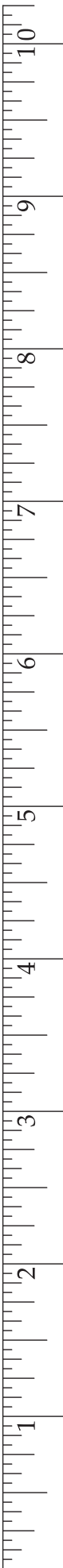

### Tessier Maxillofacial Osteotome

Catalog#	Description	Length	Width
PM-4935	Straight	8-1/4" (210 mm)	10 mm
PM-4940	Curved	8-1/4" (210 mm)	10 mm



PM-4940

### Giunta Double Guarded Osteotome

Catalog#	Description	Length	Width
PM-1632	Curved	7" (178 mm)	4 mm
PM-1634	Straight	7" (178 mm)	4 mm



PM-1632

### Sheen Osteotome

Catalog#	Description	Length	Width
PM-882	Angled	7" (178 mm)	10 mm



PM-882

### Furnas Bayonet Osteotome

Catalog#	Length	Width
PM-4981	8" (203 mm)	13 mm

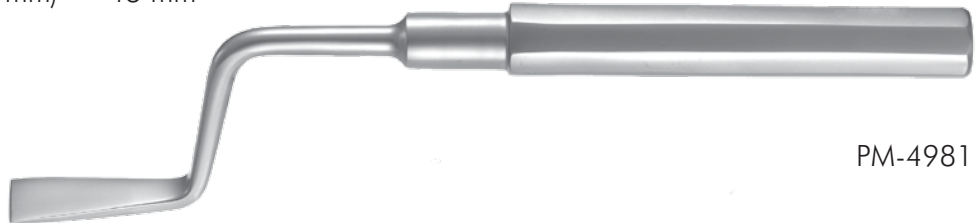

PM-4981



### Rubin Nasal Osteotome

Catalog#	Description	Length	Width
PM-7525	Straight With Stabilizer	6-1/2" (165 mm)	10 mm
PM-7526	Straight With Stabilizer	6-1/2" (165 mm)	14 mm



PM-7525

### Planas T Osteotome

Catalog#	Description	Length	Width
PM-4979	Single Guarded, Curved	7-1/2" (191 mm)	5 mm
PM-4985	Double Guarded, Curved	7-1/2" (191 mm)	8 mm



PM-4985

### Pitanguy Nasal Osteotome

Catalog#	Description	Length	Width
PM-7535	Straight	8" (203 mm)	8 mm
PM-7536	Straight	8" (203 mm)	14 mm
PM-7537	Straight	8" (203 mm)	16 mm



PM-7535

### Freer Gouge

Catalog#	Description	Length	Width
PM-4417	Straight	6-1/4" (159 mm)	4 mm
20-274*	Straight	6-1/4" (159 mm)	6 mm



\*Miltex® Brand

PM-4417

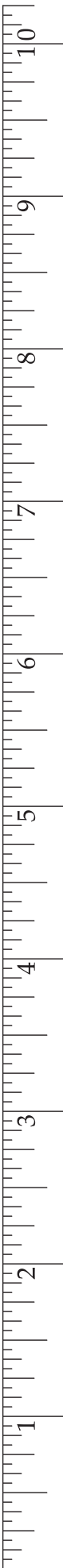

### Heden Bone Gouge

Catalog#	Length	Width
----------	--------	-------

PM-7670	8-1/2" (216 mm)	13 mm
---------	-----------------	-------

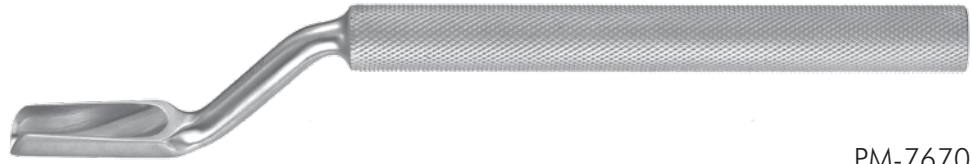

PM-7670

### Killian Septum Gouge

Catalog#	Length	Width
----------	--------	-------

PM-4419	6-1/4" (159 mm)	5 mm
---------	-----------------	------



PM-4419

### West Bone Gouge

Catalog#	Length	Width
----------	--------	-------

PM-7665	7-1/2" (191 mm)	6 mm
---------	-----------------	------



PM-7665

### Parkes Hump Gouge

Catalog#	Description	Length	Width
----------	-------------	--------	-------

PM-7595	Double Guarded	7" (178 mm)	6 mm
---------	----------------	-------------	------



PM-7595





### Blumenthal Bone Rongeur

Catalog#	Description	Length	Bite
22-480*	Slightly Curved 30°	6" (152 mm)	3 x 10 mm bite tapered to 4 mm
22-482*	Fully Curved 90°	6" (152 mm)	3 x 10 mm bite tapered to 4 mm

\*Miltex® Brand



22-480

### Blumenthal Bone Rongeur

Catalog#	Description	Length	Bite
PM-4463	Narrow, Straight	7-1/2" (191 mm)	5 mm

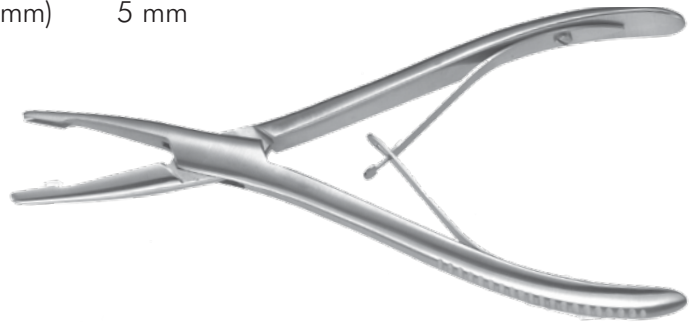

PM-4463

### Beyer Rongeur With Dual Action

Catalog#	Description	Length	Bite
19-844*	Delicate, Slightly Curved	7" (178 mm)	3 mm

\*Miltex® Brand



19-844

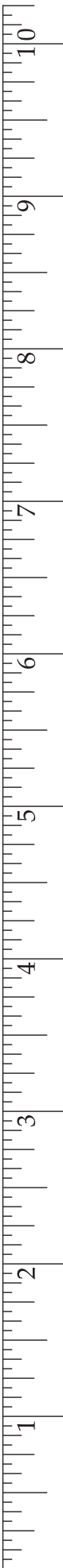

### Hardee Bone Rongeur With Dual Action

Catalog#	Description	Length	Bite
PM-4868	Straight	6" (152 mm)	2 mm, extra fine
PM-4869	Curved	6" (152 mm)	2 mm, extra fine
PM-4784	Curved	6" (152 mm)	3 mm



PM-4869

### Kleinert-Kutz Rongeur With Dual Action

Catalog#	Description	Length	Bite
27-1297*	Strong Curve	6" (152 mm)	3 mm x 8 mm

\*Miltex® Brand



27-1297

### Friedman Rongeur

Catalog#	Description	Length	Bite
PM-4775	Curved, Delicate Tapered Jaw	5-1/4" (133 mm)	3 mm wide x 11 mm long



PM-4775

### Prentis Rongeur

Catalog#	Description	Length	Bite
----------	-------------	--------	------

PM-4776	Curved	5-1/4" (133 mm)	4 mm Wide
---------	--------	-----------------	-----------



### Ruskin Bone Rongeur With Dual Action

Catalog#	Description	Length	Bite
----------	-------------	--------	------

19-848*	Straight	6" (152 mm)	3 mm
19-849*	Curved	6" (152 mm)	3 mm
19-850*	Straight	7-1/4" (184 mm)	5 mm
19-852*	Curved	7-1/4" (184 mm)	5 mm
19-854*	Straight	7-1/4" (184 mm)	7 mm
19-856*	Curved	7-1/4" (184 mm)	7 mm

\*Miltex® Brand



PM-4776

19-852

### Ferris-Smith Spurling Rongeur

Catalog#	Description	Length	Bite
----------	-------------	--------	------

26-466*	Curved Up	7" (178 mm)	3 mm x 10 mm
26-461*	Straight	7" (178 mm)	3 mm x 10 mm
26-462*	Straight	7" (178 mm)	4 mm x 10 mm

\*Miltex® Brand



26-466



26-462

**Cottle-Kazanjian Nasal Hump Forceps**

Catalog#	Description	Length	Jaw Length
----------	-------------	--------	------------

21-624*	Narrow Jaws, Straight	7-1/2" (191 mm)	29 mm
---------	-----------------------	-----------------	-------

\*Miltex® Brand



**Rowland (Ruskin) Nasal Hump Forceps With Dual Action**

21-624

Catalog#	Description	Length
----------	-------------	--------

21-628*	Narrow Jaws, Straight	7" (178 mm)
---------	-----------------------	-------------

\*Miltex® Brand

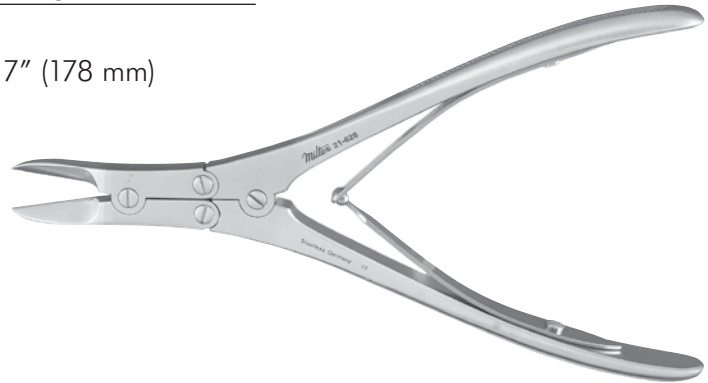

**Liston Bone Cutting Forceps**

Catalog#	Description	Length	Jaw Length
----------	-------------	--------	------------

21-628

27-1390*	Straight	5-1/2" (140 mm)	24 mm
27-1400*	Angled-on-Flat	5-1/2" (140 mm)	24 mm
27-1392*	Straight	7-1/2" (191 mm)	41 mm
27-1402*	Angled-on-Flat	7-1/2" (191 mm)	41 mm

\*Miltex® Brand

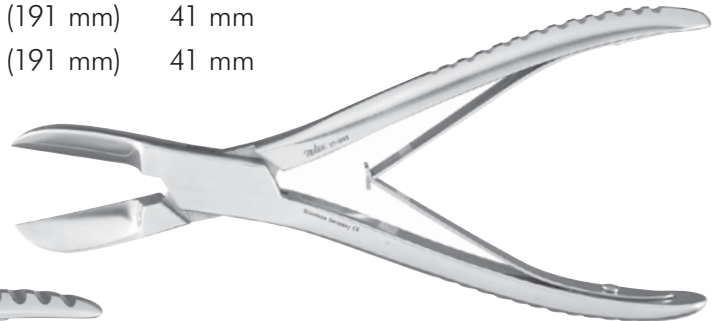

27-1392

27-1400



### McIndoe Bone Cutting Forceps

Catalog#	Description	Length	Jaw Length
PM-1422	Angled-on-Flat, Dual Action	7-1/4" (184 mm)	25 mm



PM-1422

### Key (Stille-Horseley) Bone Cutting Forceps

Catalog#	Description	Length
25-396*	Angled, Dual Action	10" (254 mm)

\*Miltex® Brand



25-396

### Ruskin-Liston Bone Cutting Forceps With Dual Action

Catalog#	Description	Length
25-384*	Straight, Standard Blades	7-1/2" (191 mm)
25-385*	Slightly Angled, Standard Blades	7-1/2" (191 mm)

\*Miltex® Brand



25-385

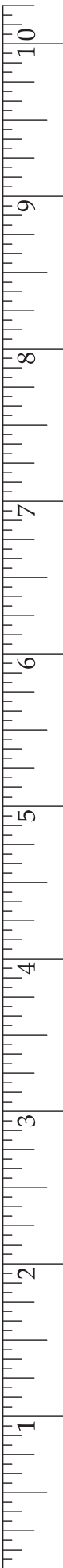

### Volkmann Scoop

Catalog#	Description	Length	Scoop 1	Scoop 2
PM-1476A	Double-Ended	8-1/2" (216 mm)	3 mm x 5 mm	5 mm x 10 mm
PM-1476B	Double-Ended	8-1/2" (216 mm)	4 mm x 7 mm	6 mm x 12 mm
PM-1476C	Double-Ended	8-1/2" (216 mm)	5 mm x 9 mm	7 mm x 13 mm



PM-1476A

### Rosen Knife Curette, Octagonal Handle

Catalog#	Description	Length
19-505*	Small 2 mm diameter blade, angled up 45 degrees	6" (152 mm)
19-506*	Large 2.5 mm diameter blade, angled up 45 degrees	6" (152 mm)



19-505

19-506

\*Miltex® Brand



19-506

### House-Sheehy Knife Curette, Octagonal Handle

Catalog#	Description	Length
19-2504*	2 mm diameter semi-sharp blade, malleable shaft	6-1/2" (165 mm)



\*Miltex® Brand



19-2504

### House Currettes, Double-Ended with Flat Handle

Catalog#	Description	Length	Scoop 1	Scoop 2
19-2528*	Light Angle, Oval Cups	7" (178 mm)	2 mm x 2.5 mm	2.5 mm x 3 mm
19-2529*	Strong Angle, Oval Cups	7" (178 mm)	2 mm x 2.5 mm	2.25 mm x 3 mm
19-2530*	Strong Angle, Oval Cups	6" (152 mm)	2 mm x 2.5 mm	2.25 mm x 3 mm



19-2529

\*Miltex® Brand

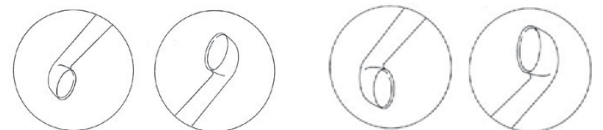

19-2528

19-2529  
19-2530

### Fox Dermal Curette, Round

Catalog#	Length	Tip Diameter
33-5B*	5-1/2" (140 mm)	1 mm
33-5A*	5-1/2" (140 mm)	2 mm
33-5*	5-1/2" (140 mm)	3 mm
33-4*	5-1/2" (140 mm)	4 mm
33-3*	5-1/2" (140 mm)	5 mm
33-2*	5-1/2" (140 mm)	6 mm



\*Miltex® Brand

33-5

### Meyerhoefer Curette

Catalog#	Description	Length	Tip Diameter
PM-7989	Size 000	5" (127 mm)	0.5 mm
18-498*	Size 00	5" (127 mm)	1 mm
18-499*	Size 0	5" (127 mm)	1.5 mm
18-500*	Size 1	5" (127 mm)	1.75 mm
18-502*	Size 2	5" (127 mm)	2 mm
18-504*	Size 3	5" (127 mm)	2.5 mm
18-506*	Size 4	5" (127 mm)	3.5 mm
PM-7996	Size 5	5" (127 mm)	4 mm
PM-7997	Size 6	5" (127 mm)	4.5 mm



\*Miltex® Brand

18-506

### Converse Double-Ended Curette

Catalog#	Length	Scoop 1	Scoop 2
PM-7970	7-1/2" (191 mm)	4.8 mm x 6 mm	5.6 mm



PM-7970

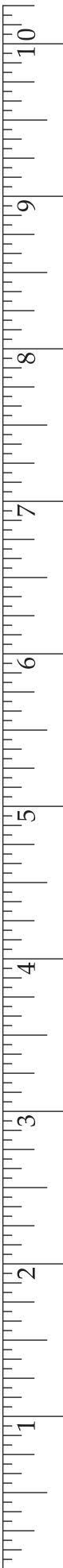

# DISSECTORS AND ELEVATORS





### Freer Spatula

Catalog#	Description	Length	Blade
PM-4427	Hoe Shaped	6-1/2" (165 mm)	5 mm x 2.8 mm



PM-4427

### Pierce Submucosal Dissector

Catalog#	Description	Length	Blade
20-230*	Right Blade and Left Blade	8-1/2" (216 mm)	7 mm x 5 mm

\*Miltex® Brand



20-230

### Gorney-Hammrick Suction Dissector

Catalog#	Length	Width
PM-3825	7-1/2" (191 mm)	3 mm

**Combination Instrument:**

- Ideal for various delicate and facial procedures.
- Also excellent for elevating the palatal flap during cleft palate surgery.



PM-3825

### Penn Breast Dissector

Catalog#	Description	Length	Width
PM-625	Straight	12-3/4" (324 mm)	1" (25 mm)



PM-625

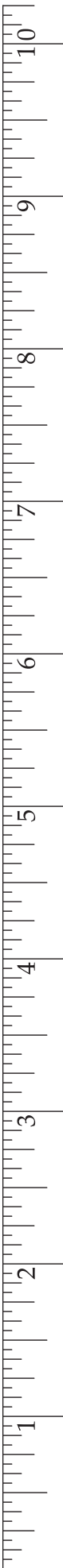

### MacCollum-Dingman Breast Dissector

Catalog#	Length	Width
PM-630	17" (432 mm)	1-1/2" (38 mm)

Ideal for Subglandular or Subpectoral Dissection. May be used in both transaxillary or inframammary procedures.



PM-630

### MacCollum-Dingman Submammary Dissector

Catalog#	Length	Width
PM-635	11-3/4" (298 mm)	25/32" (20 mm)



PM-635

### McInnis Polycurette Breast Instrument

Catalog#	Length	Width
PM-637	12-1/2" (318 mm)	1-11/64" (30 mm)



PM-637

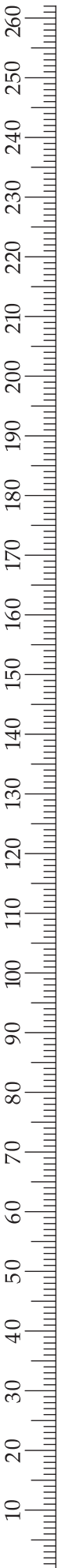

### TBTS-Style Breast Dissector, Paddle-Shaped

Catalog#	Description	Length
PM-909L	Spatula, Long Pattern	17-1/2" (445 mm) overall length 13" (330 mm) shaft length
PM-909	Spatula, Short Pattern	13" (330 mm) overall length 8-1/2" (216 mm) shaft length

The TBTS-Style Breast Dissectors are ideal for breast augmentation, reduction and lift procedures. The Angulated and Spatulated Dissectors are designed to dissect the connective tissue inside the breast pocket without the need for multiple dissectors.



PM-909L



PM-909

### TBTS-Style Breast Dissector, Hockey-Stick

Catalog#	Description	Length
PM-910L	Angulated, Long Pattern	17-1/2" (445 mm) overall length 13" (330 mm) shaft length
PM-910	Angulated, Short Pattern	13" (330 mm) overall length 8-1/2" (216 mm) shaft length



PM-910L



PM-910

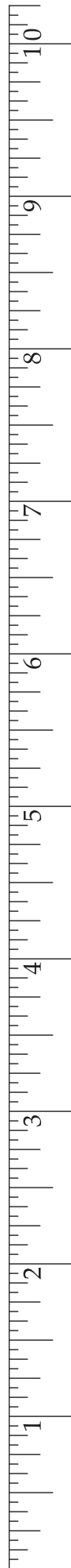

## Transumbilical Breast Augmentation (TUBA) Set

The following instruments may be used in Transumbilical breast augmentation procedures. The set of 5 complete instruments includes: Large Trocar Tube, Small Trocar Tube, V-Shaped Dissector, Hockey Stick Dissector and the Bullet/Round Dissector which comes with 4 interchangeable tips. Resin Handles are detachable.

Catalog#	Description
----------	-------------

PM-21970	Includes 5 complete instruments: PM-21960, PM-21961, PM-21962, PM-21963, PM-21964
----------	--



PM-21961



PM-21960



PM-21964



PM-21963



PM-21962

## Transumbilical Breast Augmentation (TUBA) Dissectors - with lightweight detachable, autoclavable resin handle

The V-Shape, Hockey Stick and Bullet/Round Tip Dissectors are used to dissect and break apart connective tissue during the formation of the access channel from the umbilicus to the breast. These instruments may also be used to create the pocket underneath the breast into which the implant will be inserted.

The Bullet and Round Tip Dissector has four removable tips that can be interchanged on the dissector shaft.

Catalog#	Description	Shaft Length	Total Length	Tip Width
PM-21960	V-Shaped Breast Dissector	12-1/2" (318 mm)	18-1/8" (460 mm)	1/2" (13 mm)
PM-21961	Hockey Stick Breast Dissector	12-1/4" (311 mm)	18-1/8" (460 mm)	1-1/8" (28 mm)
PM-21964	Bullet and Round Tip Breast Dissector, includes 4 tips	12-1/4" (311 mm)	20" (508 mm)	-



PM-21960



PM-21961



PM-21964

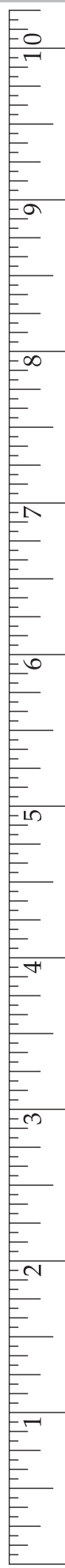

### Transumbilical Breast Augmentation (TUBA) - Trocar Breast Tubes

Catalog#	Description	Total Length	OD	ID
PM-21962	Large	14" (356 mm)	19.0 mm	17.3 mm
PM-21963	Small	13-1/2" (343 mm)	16.0 mm	14.0 mm



PM-21963



PM-21962

### Transumbilical Breast Augmentation (TUBA) - Accessories

The lightweight, detachable resin handles enable thorough cleaning and better fit into most tabletop autoclaves.

Catalog#	Description	Width	Length
PM-21965	Breast Dissector Replacement Bullet Tip, Large, for PM-21964 Breast Dissector	17.2 mm	34.2 mm
PM-21966	Breast Dissector Replacement Bullet Tip, Small, for PM-21964 Breast Dissector	13.9 mm	33.0 mm
PM-21967	Breast Dissector Replacement Round Tip, Large, PM-21964 Breast Dissector	17.2 mm	29.7 mm
PM-21968	Breast Dissector Replacement Round Tip, Small, for PM-21964 Breast Dissector	13.9 mm	30.7 mm
PM-21969	Replacement Resin Handle for Transumbilical Breast Augmentation Dissectors (PM-21960, PM-21961 and PM-21964)	-	-



PM-21965



PM-21967



PM-21966



PM-21968



PM-21969

### Jacobs Transaxillary Dissector

Catalog#	Description	Length	Width
PM-632	Curved Shaft, Chisel Edge	17" (432 mm)	1/2" (13 mm)



PM-632

### Wieslander Transaxillary Breast Dissector

Catalog#	Length	Width
PM-634	18-1/8" (460 mm)	1" (25 mm)
PM-636	17" (432 mm)	1-3/8" (35 mm)



PM-634

### Reynolds Transaxillary Breast Dissector

Catalog#	Length	Width
PM-4865	15-3/4" (400 mm)	1-1/2" (38 mm)



PM-4865



**Request our Ambulatory Surgery Center information brochure from your Customer Service Representative at 866.854.8300**

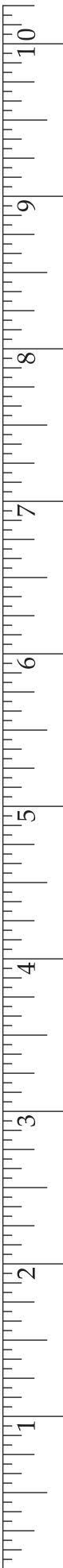

### Silverstein Breast Dissector

Catalog#	Length
----------	--------

PM-9054	14" (356 mm)
---------	--------------



PM-9054

### Agris-Dingman Submammary Dissector (for transaxillary procedures)

Catalog#	Description	Length
----------	-------------	--------

PM-4990	Left and Right Patterns, Set of Two	14" (356 mm)
---------	-------------------------------------	--------------

PM-5990	Extra Long, Left and Right Patterns, Set of Two	16" (406 mm)
---------	---	--------------



PM-4990

### Iconoclasts

Catalog#	Description	Length	Blade
----------	-------------	--------	-------

PM-638	Large	11-1/2" (292 mm)	5-3/4" (146 mm)
--------	-------	------------------	-----------------

PM-639	Small	8-3/4" (222 mm)	3-1/4" (83 mm)
--------	-------	-----------------	----------------

Iconoclasts are used in breast augmentation, reduction and lift procedures to facilitate blunt dissection. The iconoclast utilizes the gripping strength of the clinician's hand rather than the spreading strength to help minimize hand fatigue during a procedure.

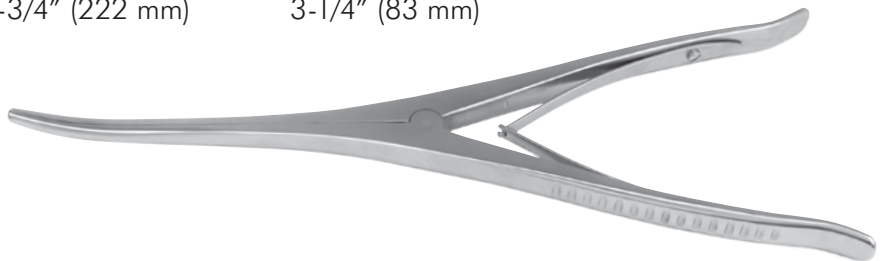

PM-638



PM-639



### Forehead and Endo Brow Dissectors

Catalog#	Description	Length
21-50*	Scalp Elevator Dissector, curved, 7 mm wide blade with Cottle style tip	9-1/2" (241 mm)
21-51*	Frontotemporal Dissector, curved, 7 mm wide blade with beveled sharp edges	9" (229 mm)
21-52*	Frontotemporal Dissector, straight, 10 mm wide blade	9" (229 mm)
21-53*	Corrugator and Procerus Muscle Dissector, S-shaped, 5 mm wide blade	9" (229 mm)



21-50 21-51 21-52 21-53

\*Miltex® Brand



21-53

### Obwegeser Mandibular Periosteal Strippers

Catalog#	Description	Length	Tip
PM-2231	J-Stripper	8" (203 mm)	5 mm
PM-2232	J-Stripper	8" (203 mm)	7 mm
PM-2233	J-Stripper	8" (203 mm)	9 mm

Mandibular Periosteal Strippers (also called "J Stripper" due to their shape) are used in Oral Maxillofacial procedures to break apart the connective tissue from the mandible. These instruments are often used during cosmetic chin implant procedures and reconstructive maxillofacial procedures.



PM-2231



PM-2232



PM-2233



### Read Periosteal Elevator

Catalog#	Description	Length	Width
----------	-------------	--------	-------

PM-1320	Single-Ended, Blunt	6" (152 mm)	5 mm
---------	---------------------	-------------	------



PM-1320

### Dingman Periosteal Elevator

Catalog#	Description	Length	Width 1	Width 2
----------	-------------	--------	---------	---------

PM-4770	Double-Ended	7-1/4" (184 mm)	5.8 mm	6.7 mm
---------	--------------	-----------------	--------	--------



PM-4770

### Clodius Elevator

Catalog#	Description	Length	Width 1	Width 2
----------	-------------	--------	---------	---------

PM-656	Double-Ended	7-1/2" (191 mm)	4.5 mm	3.3 mm
--------	--------------	-----------------	--------	--------



PM-656

### Clodius Elevator

Catalog#	Description	Length	Width 1	Width 2
----------	-------------	--------	---------	---------

PM-657	Double-Ended, with One Spoon End	7-1/2" (191 mm)	2.2 mm	3.3 mm
--------	----------------------------------	-----------------	--------	--------



PM-657

**Elevator**

Catalog#	Description	Length	Width 1	Width 2
----------	-------------	--------	---------	---------

PM-1298	Double-Ended, Angled Right and Left	6-1/2" (165 mm)	2.5 mm	2.5 mm
---------	-------------------------------------	-----------------	--------	--------



**Elevator**

Catalog#	Description	Length	Width 1	Width 2
----------	-------------	--------	---------	---------

PM-1302	Double-Ended, Spoon Shaped	6-3/4" (171 mm)	4.6 mm	3.7 mm
---------	----------------------------	-----------------	--------	--------



**Barsky Pharyngeal Flap Elevator**

Catalog#	Description	Length	Width 1	Width 2
----------	-------------	--------	---------	---------

PM-1304	Double-Ended	8-1/4" (210 mm)	3 mm	5 mm
---------	--------------	-----------------	------	------



**Kleinert-Kutz Elevator and Dissector**

Catalog#	Description	Length	Width 1	Width 2
----------	-------------	--------	---------	---------

PM-3826	Double-Ended, Slightly Curved Blades	7-3/4" (197 mm)	2 mm	3 mm
---------	--------------------------------------	-----------------	------	------

PM-3827	Double-Ended, Slightly Curved Blades	7" (178 mm)	2 mm	4 mm
---------	--------------------------------------	-------------	------	------

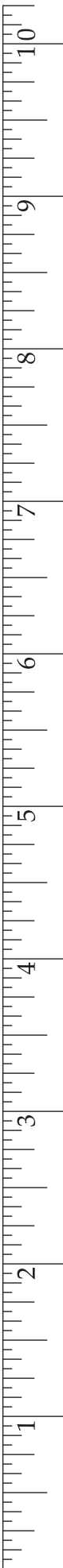



### Rowe Zygomatic Bone Elevator

Catalog#	Length
----------	--------

PM-1266	8-1/4" (210 mm)
---------	-----------------



PM-1266

### Dingman Zygomatic Elevator

For zygomatic, broken arch lifts

Catalog#	Length	Width
----------	--------	-------

PM-407	8-3/4" (222 mm)	5.5 mm
--------	-----------------	--------



PM-407

### Kilner Zygomatic Elevator

Catalog#	Description	Length	Width
----------	-------------	--------	-------

PM-3185	For Depressed Fracture of the Malar Bone	7" (178 mm)	8 mm
---------	--	-------------	------



PM-3185

### Read Periosteal Elevator

Catalog#	Description	Length	Width 1	Width 2
----------	-------------	--------	---------	---------

PM-1322	Double-Ended, Blunt	8-1/2" (216 mm)	7.5 mm	6.5 mm
---------	---------------------	-----------------	--------	--------



PM-1322

### Joseph Periosteal Elevator

Catalog#	Description	Length	Width
21-64*	Strong Curve	7" (178 mm)	6.5 mm

\*Miltex® Brand



21-64

### Joseph Periosteal Elevator

Catalog#	Description	Length	Width
PM-7760	Standard, Slightly Curved	6-3/4" (171 mm)	5 mm



PM-7760

### Joseph Periosteal Elevator

Catalog#	Description	Length	Width
PM-4306	No. 1	6-3/4" (171 mm)	2 mm
PM-4307	No. 2	6-3/4" (171 mm)	3 mm
PM-4308	No. 3	6-3/4" (171 mm)	4 mm
PM-4309	No. 4	6-3/4" (171 mm)	5 mm
PM-4310	No. 5	6-3/4" (171 mm)	3 mm



PM-4306 PM-4307 PM-4308 PM-4309 PM-4310



PM-4306

### Fomon Periosteal Elevator

Catalog#	Description	Length	Width
21-68*	Slightly Curved Blade	6-1/4" (159 mm)	4.5 mm

\*Miltex® Brand



21-68



### Miltex Periosteal Elevator

Catalog#	Description	Length	Width 1	Width 2
73-62*	Double-Ended, Slightly Curved Blade	6" (152 mm)	3 mm	6 mm

\*Miltex® Brand



73-62

### Seldin Periosteal Elevator

Catalog#	Description	Length	Width 1	Width 2
DELS23*	#23 Double-Ended, Slightly Curved Blades	7-3/4" (197 mm)	13 mm	10 mm

\*Miltex® Brand



DELS23

### Molt Periosteal Elevator

Catalog#	Description	Length	Width 1	Width 2
DELM9*	Double-Ended, #9	7" (178 mm)	5 mm	9 mm

\*Miltex® Brand



DELM9

### Lempert Elevator

Catalog#	Description	Length
19-1341*	Curved 7 mm blade, heavy pattern	7-1/4" (184 mm)

\* Miltex Brand



19-1341

### Boies Nasal Fracture Elevator

Designed for elevation and manipulation of bone fragment during nasal fracture repair.

Catalog#	Description	Length
21-61*	9 mm Wide Tip	7-3/4" (197 mm)

\*Miltex® Brand



21-61

### Goldman Displacer Septum Elevator

Catalog#	Description	Length
----------	-------------	--------

21-65\*      6 mm Wide Tip, Slight Tapered Blade      7-1/2" (191 mm)

\*Miltex® Brand



21-65

### Pollock-Dingman Septal Displacer

Catalog#	Description	Length	Width
----------	-------------	--------	-------

PM-550      Serrated      8" (203 mm)      9.5 mm



PM-550

### Roger Septum Elevator, Double-Ended

Catalog#	Description	Length	Width
----------	-------------	--------	-------

20-238\*      Curved, Semi-Sharp & Blunt Blades      7-3/4" (197 mm)      3 mm

\*Miltex® Brand



20-238

### Pennington Septum Elevator, Double-Ended

Catalog#	Description	Length	Width 1	Width 2
----------	-------------	--------	---------	---------

20-246\*      Right and Left      8-1/4" (210 mm)      4 mm      4.5 mm

\*Miltex® Brand



20-246

### Ballenger (Hajek-Ballenger) Septum Elevator, Double-Ended

Catalog#	Description	Length	Width
----------	-------------	--------	-------

20-258\*      Straight, Semi-Sharp & Blunt Blades      7-1/4" (184 mm)      5.8 mm

\*Miltex® Brand



20-258

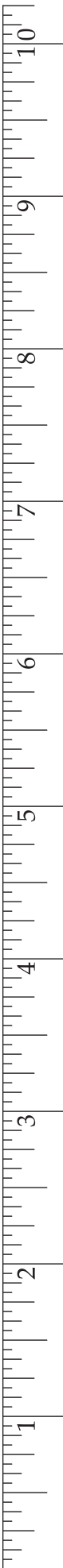

### Halle Septum Elevator

Catalog#	Description	Length	Width
----------	-------------	--------	-------

PM-4425	Narrow	7" (178 mm)	3 mm
---------	--------	-------------	------



PM-4425

### Freer Septum Elevator

Catalog#	Description	Length	Width
----------	-------------	--------	-------

18-1968*	Double-Ended, Narrow, Sharp and Blunt	7" (178 mm)	5 mm
PM-4680	Double-Ended, Narrow, Sharp and Blunt, Black Coated	7-3/4" (197 mm)	5 mm
PM-4429	Double-Ended, Wide, Sharp and Blunt	7-3/4" (197 mm)	6.5 mm



\*Miltex® Brand

18-1968

### Freer Septum Elevator

Catalog#	Description	Length	Width
----------	-------------	--------	-------

PM-4434	Double-Ended, Curved	7-1/2" (191 mm)	5 mm
---------	----------------------	-----------------	------



PM-4434

### Septum Ball End Elevator

Catalog#	Description	Length	Width 1	Width 2
----------	-------------	--------	---------	---------

20-240*	Double-Ended With Ball Tips	6-3/4" (171 mm)	2 mm	2.5 mm
---------	-----------------------------	-----------------	------	--------



\*Miltex® Brand

20-240



### McKenty Septum Elevator

Catalog#	Description	Length	Width
21-62*	Curved at Tip	6" (152 mm)	4 mm
21-63*	Curved at Tip	6" (152 mm)	5 mm

\*Miltex® Brand



21-63

### Killian Septum Elevator

Catalog#	Description	Length	Width 1	Width 2
PM-4435	Double-Ended	7-1/4" (184 mm)	4 mm w/ 3.4 mm Taper	4.3 mm w/ 3 mm Taper
PM-4441	Double-Ended	9" (229 mm)	6 mm w/ 4.5 mm Taper	4.3 mm w/ 3 mm Taper



PM-4435

### Howarth Septum Elevator

Catalog#	Description	Length	Width
PM-4440	Double-Ended	8-1/2" (216 mm)	5 mm



PM-4440

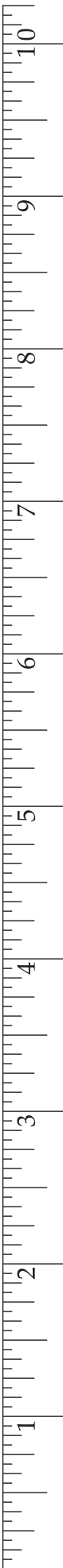

### Pennington Septum Elevator

Catalog#	Description	Length
----------	-------------	--------

20-246\* Sharp, with Blades to Left and Right Side 8-1/4" (210 mm)



\*Miltex® Brand

20-246

### Molt Dissector and Raspatory

Catalog#	Description	Length	Width
----------	-------------	--------	-------

PM-4436 Double-Ended 7" (178 mm) 5 mm



PM-4436

### Dunning Elevator and Curette

Catalog#	Description	Length
----------	-------------	--------

20-242\* Blunt Elevator and Sharp Small Oval Curette 8-1/4" (210 mm)



\*Miltex® Brand

20-242

### McCoy-Ferris-Smith Periosteal Elevator

Catalog#	Length	Width
----------	--------	-------

PM-4903 5-3/4" (146 mm) 6.5 mm



PM-4903

### Tessier Periosteal Elevator

Catalog#	Description	Length	Width
PM-4971	Curved	7" (178 mm)	6 mm
PM-4972	Curved	7" (178 mm)	7 mm
PM-4973	Curved	7" (178 mm)	9 mm
PM-4974	Curved	7" (178 mm)	11 mm



PM-4971

### Obwegesser-Freer Periosteal Elevator

Catalog#	Description	Length	Width
PM-4977	Slight Curve	9" (229 mm)	6.3 mm
PM-4978	Strong Curve	9" (229 mm)	6.3 mm

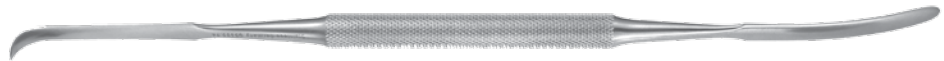

PM-4977

### Salinger Reduction Instrument

Catalog#	Length	Width
PM-4847	5 1/2" (140 mm)	9.5 mm

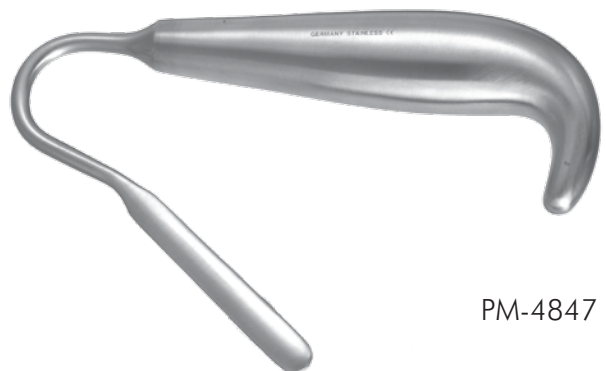

PM-4847

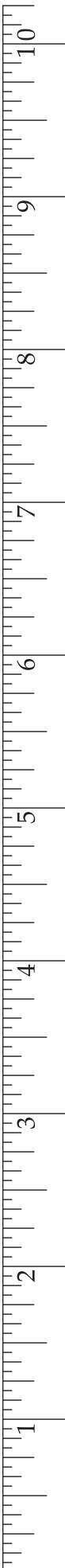

### Cottle Skin Elevator

Very versatile for facial and rhinoplasty procedures. Also ideal for creating a pocket for malar implants.

Catalog#	Description	Length	Width
21-72*	Slightly Curved	7-1/2" (191 mm)	9 mm

\*Miltex® Brand



21-72

### Cottle Graduated Elevator, Double Ended

Catalog#	Description	Length	Width 1	Width 2
PM-7741	Graduated in cm, Delicate	7-3/4" (197 mm)	3 mm	2.1 mm
PM-7740	Graduated in cm	8-7/8" (226 mm)	4.9 mm	4.9 mm
21-60*	Graduated in cm	9" (229 mm)	3.8 mm	3.3 mm

\*Miltex® Brand

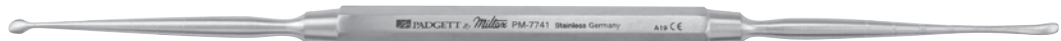

PM-7741



PM-7740

### Cronin Cleft Palate Elevator

Catalog#	Description	Length	Width
PM-600	Large	7-1/4" (184 mm)	5 mm x 15 mm
PM-601	Medium	7-1/4" (184 mm)	5 mm x 13 mm
PM-602	Small	7-1/4" (184 mm)	5 mm x 8 mm



PM-600

**Blair Cleft Palate Elevator**

Catalog#	Description	Length	Width
----------	-------------	--------	-------

PM-7800	L-Shaped	9" (229 mm)	5 mm
---------	----------	-------------	------



PM-7800

**Blair Cleft Palate Elevator**

Catalog#	Description	Length	Width
----------	-------------	--------	-------

PM-7801	Right Angle	8" (203 mm)	5 mm
---------	-------------	-------------	------



PM-7801

**Blair Cleft Palate Elevator**

Catalog#	Description	Length	Width
----------	-------------	--------	-------

PM-7802	Curved	9" (229 mm)	6.5 mm
---------	--------	-------------	--------



PM-7802



### Mitchell Trimmer

Knife blade and spoon shaped elevator are ideal for precise trimming of mucosa

Catalog#	Description	Length	Width
PM-1312	Double-Ended	6 1/2" (165 mm)	4 mm



PM-1312

### Pickrell-Cottle Elevator

Catalog#	Description	Length	Width 1	Width 2
PM-4808	Slightly Curved, Double-Ended	9" (229 mm)	4.3 mm	4.9 mm



PM-4808

### House Elevator and Chisel

Catalog#	Description	Length	Width
19-2518*	Elevator, Tip Angled 15 Degrees, Octagonal Handle, Referred to as "The Gimmick"	6-1/2" (165 mm)	1 mm x 12 mm
19-2520*	Elevator & Chisel, Curved Scraping Tip, Flat Bayonet Handle	6-3/4" (171 mm)	1 mm



19-2518



19-2518

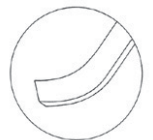

19-2520



19-2520

\*Miltex® Brand



# FORCEPS



Tungsten Carbide  
Dressing & Tissue  
Microsurgical  
Bipolar  
Specialty Forceps  
Clamps  
Ring-Handled Hemostats

## ANATOMY OF MILTEX® AND PADGETT® FORCEPS

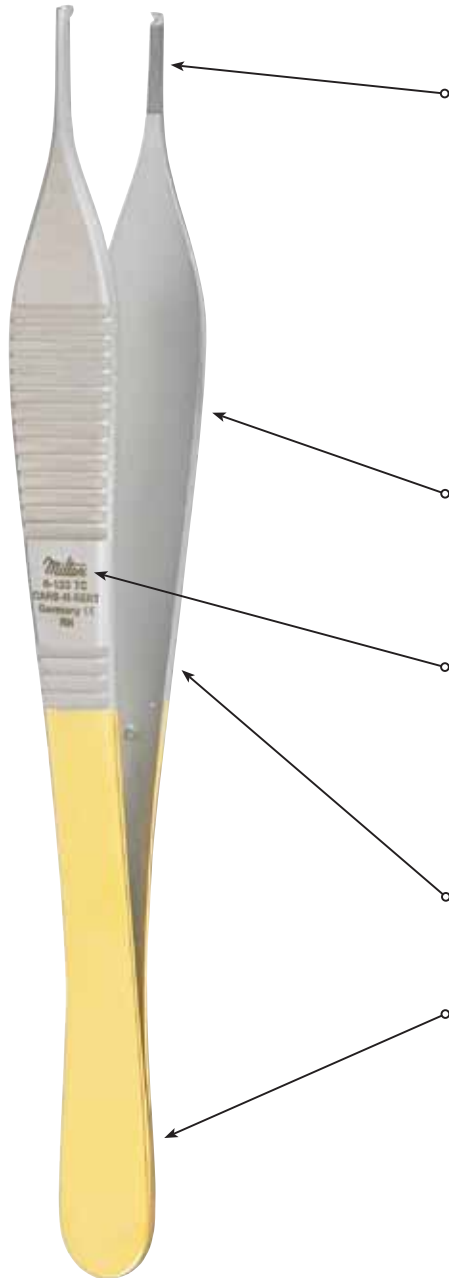

### **TUNGSTEN CARBIDE**

Tips are made of Tungsten Carbide, the hardest steel made for surgical instruments.

Serrations are precision milled into the Tungsten Carbide material forming 4,000 pyramid-shaped teeth per square inch to provide a positive non-slip grip. Tissue forceps have precision formed teeth with perfect alignment to provide a durable and reliable grasp of the most delicate or toughest tissues, as well as needles, sutures, dressing materials, delicate vessels, etc.

### **SPRING TENSION**

Properly set to consistently maintain proper position to ensure optimum grip without having to apply excess tension.

### **LASER ETCHING**

All Miltex forceps are laser etched with our logo and catalog number for easy re-ordering. Advanced laser techniques are used and will not harm or damage the instrument as did older and traditional acid etching techniques.

### **SATIN FINISH**

Each instrument is satin finished to reduce glare.

### **TANG**

Evenly welded and finished with rounded edges for the utmost comfort. Gold finished handles differentiate these forceps as precision instruments.

*\* Note: cold or chemical sterilization is not recommended for Tungsten Carbide instruments*



### Adson Dressing Forceps, Tungsten Carbide

Catalog#	Description	Length
PM-2500	Standard, Cross-Serrated	4-3/4" (121 mm)
PM-2501	Delicate, Cross-Serrated	4-3/4" (121 mm)
6-118TC*	Delicate, Cross-Serrated	4-3/4" (121 mm)
PM-2505	Delicate, Smooth	4-3/4" (121 mm)
6-129TC*	Delicate, Cross-Serrated	6" (152 mm)

\*Miltex® Brand



PM-2500

### Adson Tissue & Suture Forceps, Tungsten Carbide

Catalog#	Description	Length
6-123TC*	1x2 Teeth With Cross-Serrated Tying Platform	4-3/4" (121 mm)
6-130TC*	1x2 Teeth With Cross-Serrated Tying Platform	6" (152 mm)

\* Miltex® Brand



6-123TC

### Horton-Adson Tissue & Suture Forceps, Tungsten Carbide

Catalog#	Description	Length
PM-2503	1x2 Teeth With Cross-Serrated Tying Platform	4-3/4" (121 mm)

\* Miltex® Brand



PM-2503

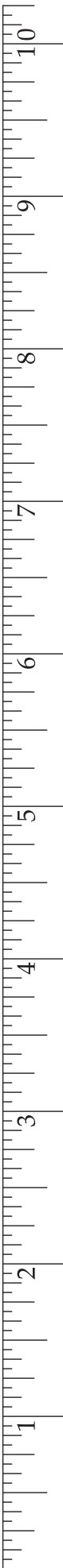

### Gorney-Adson Tissue & Suture Forceps, Tungsten Carbide

Catalog#	Description	Length
----------	-------------	--------

PM-2511	1x2 Teeth With Smooth Tying Platform	4-3/4" (121 mm)
---------	--------------------------------------	-----------------



PM-2511

### Brown-Adson Tissue & Suture Forceps, Tungsten Carbide

Catalog#	Description	Length
----------	-------------	--------

PM-3503	4x4 Side Grasping Teeth With Cross-Serrated Tying Platform	4-3/4" (121 mm)
6-124TC*	7x7 Side Grasping Teeth With Cross-Serrated Tying Platform	4-3/4" (121 mm)



\* Miltex® Brand

PM-3503

### Hudson (Ewald) Dressing Forceps, Tungsten Carbide

Catalog#	Description	Length
----------	-------------	--------

6-113TC*	Cross-Serrated	6" (152 mm)
----------	----------------	-------------



\*Miltex® Brand

6-113TC

### Hudson (Ewald) Tissue & Suture Forceps, Tungsten Carbide

Catalog#	Description	Length
----------	-------------	--------

6-115TC*	1x2 Teeth With Cross-Serrated Tying Platform	6" (152 mm)
----------	--	-------------



\* Miltex® Brand

6-115TC

### General Style Dressing Forceps, Tungsten Carbide

Catalog#	Description	Length
----------	-------------	--------

PM-2510	Cross-Serrated	6" (152 mm)
---------	----------------	-------------



PM-2510

### Cushing Dressing Forceps, Tungsten Carbide

Catalog#	Description	Length
----------	-------------	--------

6-30TC*	Cross-Serrated	6" (152 mm)
---------	----------------	-------------



\* Miltex® Brand

6-30TC

### Cushing Dressing Forceps, Tungsten Carbide

Catalog#	Description	Length
----------	-------------	--------

PM-2520	Cross-Serrated	7" (178 mm)
6-166TC*	Cross-Serrated	7" (178 mm)



\* Miltex® Brand

PM-2520

### Potts-Smith Dressing Forceps, Tungsten Carbide

Catalog#	Description	Length
PM-2530	Cross-Serrated	9" (229 mm)
6-158TC*	Cross-Serrated	9-3/4" (248 mm)
6-156TC*	Cross-Serrated	8-1/4" (210 mm)
6-154TC*	Cross-Serrated	7" (178 mm)

\*Miltex® Brand



PM-2530

### Evans Pelvic Dressing Forceps

Catalog#	Description	Length
6-165TC*	Cross-Serrated	10" (254 mm)

\* Miltex® Brand



6-165TC

### Crow Coagulating Forceps, Tungsten Carbide

Catalog#	Description	Length
PM-9043	Cross-Serrated, Insulated	9" (229 mm)



PM-9043

### Jeweler's Forceps #4

Catalog#	Description	Length
----------	-------------	--------

PM-4698	Diamond Dust	4" (102 mm)
---------	--------------	-------------



PM-4698

### Jeweler's Forceps #5A

Catalog#	Description	Length
----------	-------------	--------

PM-4699	Diamond Dust	4-1/4" (108 mm)
---------	--------------	-----------------



PM-4699

### Jeweler's "Dilator" Forceps

Catalog#	Description	Length
----------	-------------	--------

PM-4697	Diamond Dust	4-1/2" (114 mm)
---------	--------------	-----------------

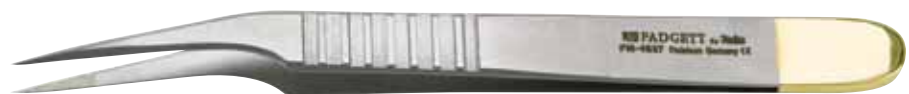

PM-4697



### Cushing Bayonet Dressing Forceps, Tungsten Carbide

Catalog#	Description	Length
PM-2525	Cross-Serrated	7-3/4" (197 mm)



PM-2525

### Rees Bayonet Dressing Forceps, Tungsten Carbide

Catalog#	Description	Length
PM-3504	Cross-Serrated	5-1/2" (140 mm)
PM-3505	Cross-Serrated	6-1/4" (159 mm)



PM-3505

### Adson Bayonet Dressing Forceps, Tungsten Carbide

Catalog#	Description	Length
6-198TC*	Cross-Serrated	8-1/4" (216 mm)



6-198TC

\* Miltex® Brand

### Adson Tissue Forceps

Catalog#	Description	Length
6-120*	Delicate, 1x2 Teeth	4-3/4" (121 mm)
6-120XL*	Fenestrated**, Delicate, 1x2 Teeth	4-3/4" (121 mm)
6-121*	Delicate, 1x2 Teeth and Serrated	4-3/4" (121 mm)
6-123*	Delicate, 1x2 Teeth and Smooth Tying Platform	4-3/4" (121 mm)
6-123XL*	Fenestrated**, Delicate, 1x2 Teeth and Smooth Tying Platform	4-3/4" (121 mm)
17-2500	Extra Delicate, (0.5 mm Wide), 1x2 Teeth	4-3/4" (121 mm)
6-122*	Delicate, 2x3 Teeth	4-3/4" (121 mm)
PM-6115	Delicate, 2x3 Teeth and Serrated	4-3/4" (121 mm)



6-120

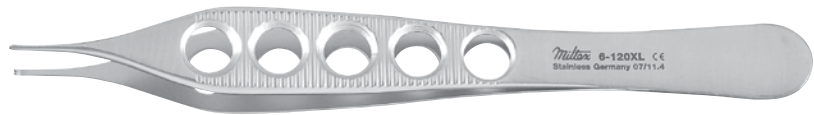

6-120XL

\*Miltex® Brand

\*\*Fenestrated lightweight handles

### Adson Dressing Forceps

Catalog#	Description	Length
6-118*	Delicate, Serrated	4-3/4" (121 mm)
6-118XL**	Fenestrated**, Delicate, Serrated	4-3/4" (121 mm)
17-2510*	Extra Delicate, (0.5 mm Wide), Serrated	4-3/4" (121 mm)
PM-6105	Delicate, Cross-Serrated	4-3/4" (121 mm)
PM-6106	Delicate, Smooth	4-3/4" (121 mm)



6-118

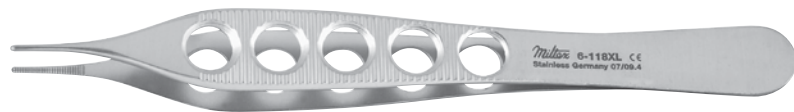

6-118XL

\*Miltex® Brand

\*\*Fenestrated lightweight handles

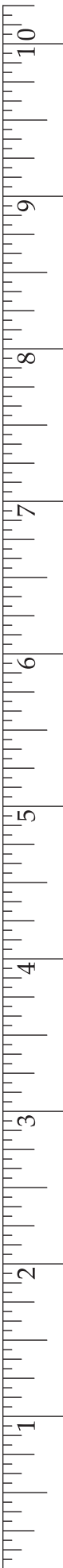

### Adson Light Touch Tissue Forceps (Narrow Handles)

Catalog#	Description	Length
PM-6127	Delicate, 1x2 Teeth	4-3/4" (121 mm)
PM-6129	Delicate, 1x2 Teeth and Smooth Tying Platform	4-3/4" (121 mm)



PM-6127

### Adson Light Touch Dressing Forceps (Narrow Handles)

Catalog#	Description	Length
PM-6128	Delicate, Serrated	4-3/4" (121 mm)

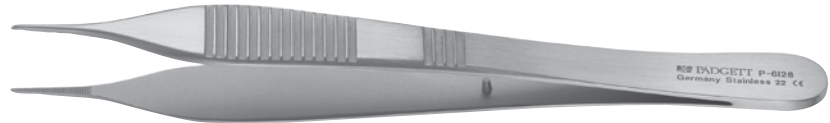

PM-6128

### Ewald (Hudson) Tissue Forceps

Catalog#	Description	Length
6-114*	1x2 Teeth	4-3/4" (121 mm)

\*Miltex® Brand



6-114

### Ewald (Hudson) Dressing Forceps

Catalog#	Description	Length
6-112*	Serrated	4-3/4" (121 mm)

\*Miltex® Brand



6-112



### Adson Angular Tipped Tissue Forceps

Catalog#	Description	Length
6-120A*	1x2 Teeth	4-3/4" (121 mm)
PM-6121	1x2 Teeth and Serrated	4-3/4" (121 mm)

\*Miltex® Brand



6-120A

### Brown-Adson Tissue Forceps

Catalog#	Description	Length
6-124*	7x7 Side Grasping Teeth	4-3/4" (121 mm)
6-124XL*	Fenestrated**, 7x7 Side Grasping Teeth	4-3/4" (121 mm)

\*Miltex® Brand

\*\*Fenestrated lightweight handles



6-124XL

### Brown-Adson Tissue Forceps

Catalog#	Description	Length
PM-6125	9x9 Side Grasping Teeth	4-3/4" (121 mm)

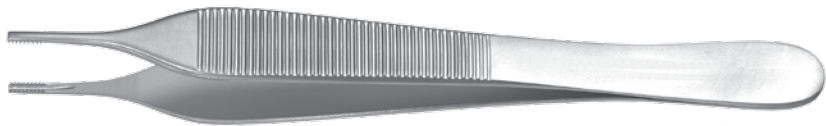

PM-6125

### Brown-Adson Angular Tipped Tissue Forceps

Catalog#	Description	Length
PM-6126	9x9 Side Grasping Teeth	4-3/4" (121 mm)

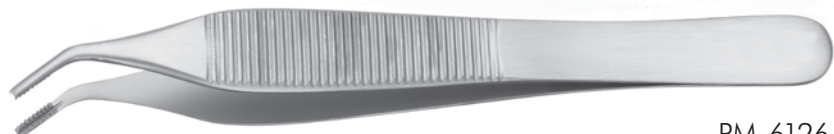

PM-6126

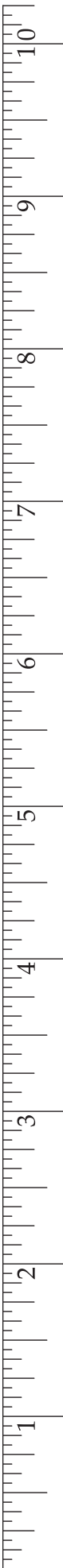



### Brown Tissue Forceps

Catalog#	Description	Length
6-138*	8x8 Side Grasping Teeth	6" (152 mm)
6-140*	8x8 Side Grasping Teeth	8" (203 mm)



\*Miltex® Brand

6-138

### Cushing-Brown Tissue Forceps

Catalog#	Description	Length
PM-4185	Delicate, 9x9 Side Grasping Teeth	7" (178 mm)

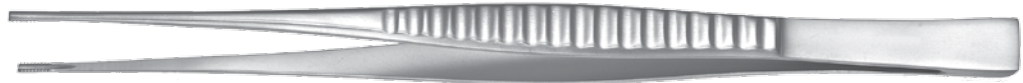

PM-4185

### Griffiths-Brown Tissue Forceps

Catalog#	Description	Length
6-127*	Delicate, 9x9 Side Grasping Teeth 1.5 x 5 mm, Brown-Type Teeth	4-1/4" (108 mm)



\*Miltex® Brand

6-127

### Feld Blepharoplasty Forceps

Catalog#	Description	Length
----------	-------------	--------

PM-4681 Delicate, 9x9 Brown-Type Side Grasping Teeth 4-1/4" (108 mm)

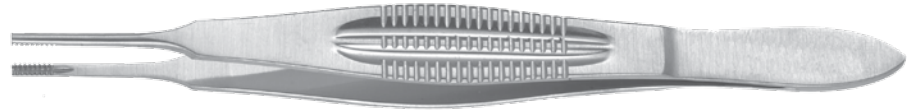

PM-4681

### Grazer Blepharoplasty Forceps

Catalog#	Description	Length
----------	-------------	--------

PM-6245 6x7 In-Line Teeth 4-1/4" (108 mm)



PM-6245

### Thumb Tissue Forceps

Catalog#	Description	Length
----------	-------------	--------

6-40*	1x2 Teeth	4-1/2" (114 mm)
6-42*	1x2 Teeth	5" (127 mm)
6-44*	1x2 Teeth	5-1/2" (140 mm)
6-46*	1x2 Teeth	6" (152 mm)
6-47*	1x2 Teeth	7" (178 mm)
6-48*	1x2 Teeth	8" (203 mm)
6-50*	1x2 Teeth	10" (254 mm)
6-52*	1x2 Teeth	12" (305 mm)
PM-4188	1x2 Teeth, Extra Fine	5-1/2" (140 mm)



\*Miltex® Brand

6-40

### Thumb Dressing Forceps

Catalog#	Description	Length
6-2*	Serrated	4" (102 mm)
6-4*	Serrated	4-1/2" (114 mm)
6-6*	Serrated	5" (127 mm)
6-8*	Serrated	5-1/2" (140 mm)
6-10*	Serrated	6" (152 mm)
6-12*	Serrated	7" (178 mm)
6-14*	Serrated	8" (203 mm)
6-16*	Serrated	10" (254 mm)
6-18*	Serrated	12" (305 mm)
6-26*	Delicate, Serrated	5" (127 mm)
PM-4187	Extra Fine, Serrated	5-1/2" (140 mm)



\*Miltex® Brand

6-4

### Lanes Tissue Forceps

Catalog#	Description	Length
PM-0314	1x2 Teeth, Cross-Serrated	5-3/4" (146 mm)
PM-0316	2x3 Teeth, Cross-Serrated	5-3/4" (146 mm)
PM-0320	1x2 Teeth, Cross-Serrated	7" (178 mm)
PM-0322	2x3 Teeth, Cross-Serrated	7" (178 mm)



PM-0320

### Potts-Smith Tissue Forceps

Catalog#	Description	Length
6-160*	1x2 Teeth, Serrated	7" (178 mm)
6-162*	1x2 Teeth, Serrated	8-1/4" (210 mm)
6-164*	1x2 Teeth, Serrated	9-1/2" (241 mm)

\*Miltex® Brand



6-160

### Potts-Smith Dressing Forceps

Catalog#	Description	Length
6-154*	Serrated	7" (178 mm)
6-156*	Serrated	8-1/4" (210 mm)
6-158*	Serrated	9-1/2" (241 mm)

\*Miltex® Brand



6-154

### Cushing Tissue Forceps

Catalog#	Description	Length
6-168*	Delicate, 1x2 Teeth, With Scraper End	7" (178 mm)

\*Miltex® Brand



6-168

### Cushing Dressing Forceps

Catalog#	Description	Length
----------	-------------	--------

6-166*	Delicate, Serrated, With Scraper End	7" (178 mm)
--------	--------------------------------------	-------------



\*Miltex® Brand

6-166

### Semken Tissue Forceps

Catalog#	Description	Length
----------	-------------	--------

6-106*	1x2 Teeth	5" (127 mm)
6-107*	1x2 Teeth, Curved	5" (127 mm)
6-108*	2x3 Teeth	5" (127 mm)
6-109A*	1x2 Teeth	6" (152 mm)



\*Miltex® Brand

6-106

### Semken Dressing Forceps

Catalog#	Description	Length
----------	-------------	--------

6-104*	Serrated	5" (127 mm)
6-109*	Serrated	6" (152 mm)



\*Miltex® Brand

6-104

### Stille Tissue Forceps

Catalog#	Description	Length
----------	-------------	--------

6-110*	4x5 Teeth	5" (127 mm)
--------	-----------	-------------

\*Miltex® Brand



6-110

### Graul Tissue Forceps

Catalog#	Description	Length	Tips
----------	-------------	--------	------

PM-4842	1x2 Teeth	4" (102 mm)	0.5 mm
---------	-----------	-------------	--------



PM-4842

### Cobaugh Iris Tissue Forceps

Catalog#	Description	Length
----------	-------------	--------

PM-4212	1x2 Teeth	4" (102 mm)
---------	-----------	-------------



PM-4212

### Olmstead Tissue Forceps

Catalog#	Description	Length
----------	-------------	--------

PM-4719	Delicate, 1x2 Teeth	2-3/4" (70 mm)
---------	---------------------	----------------



PM-4719

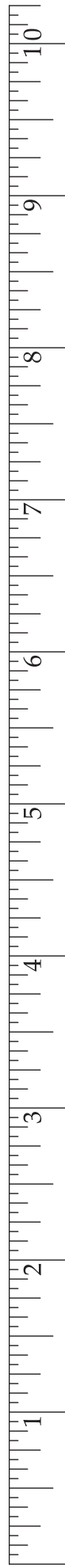

### Bishop-Harmon Iris Tissue Forceps

Catalog#	Description	Length	Jaw
PM-4791	1x2 Standard Teeth	3-1/4" (83 mm)	0.6 mm
PM-4792	1x2 Delicate Teeth	3-1/4" (83 mm)	0.4 mm
PM-4793	1x2 Extra Delicate Teeth	3-1/4" (83 mm)	0.3 mm



PM-4791

### Foerster Iris Tissue Forceps

Catalog#	Description	Length
18-796*	Octagonal Grip, Straight, 1x2 Teeth, 0.5 mm wide	3-3/4" (95 mm)
18-798*	Octagonal Grip, Full Curve, 1x2 Teeth, 0.5 mm wide	3-3/4" (95 mm)



\*Miltex® Brand

18-796

### Adson Dissecting Forceps

Catalog#	Description	Length
PM-0278	Lightweight Handles with Fine 1x2 Teeth on Smooth Tips	4-3/4" (121 mm)
PM-0280	Lightweight Handles with Fine 1x2 Teeth on Smooth Tips	7" (178 mm)
PM-0284	Lightweight Handles with Fine Serrated Tips (No Teeth)	7" (178 mm)



PM-0280



PM-0284



### Barsky Dissecting Forceps

Catalog#	Description	Length
PM-0286	Multiple, Delicate 9x9 Teeth	6" (152 mm)



PM-0286

### Barsky Dissecting Forceps

Catalog#	Description	Length
PM-0288	Broad Serrated Tips	6" (152 mm)



PM-0288

### Gillies Dissecting Forceps

Catalog#	Description	Length
PM-0306	Fine 1x2 Teeth and Serrated	6" (152 mm)

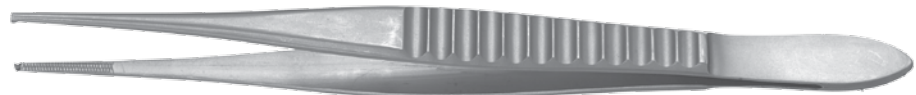

PM-0306

### Waugh Dissecting Forceps

Catalog#	Description	Length
PM-0346	Fine 1x2 Teeth and Serrated	7" (178 mm)
PM-0344	Fine 1x2 Teeth and Serrated	8" (203 mm)
PM-0350	Fine Serrations	7" (178 mm)
PM-0348	Fine Serrations	8" (203 mm)

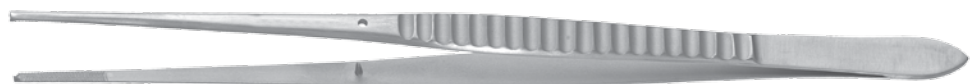

PM-0344

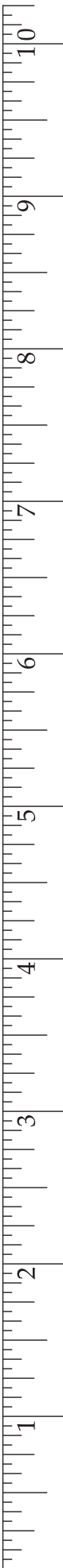

### McIndoe Dissecting Forceps

Catalog#	Description	Length
PM-0330	Serrated	6" (152 mm)
PM-0332	Smooth	6" (152 mm)



PM-0330

### Evan Modified McIndoe Dissecting Forceps

Catalog#	Description	Length
PM-0302	"Horseshoe" Shaped Tips	6-1/2" (165 mm)

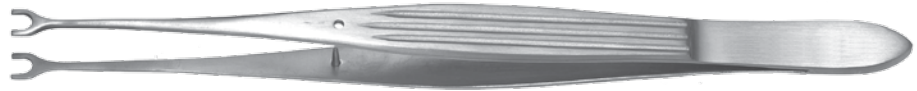

PM-0302

### Mount Vernon Hospital Pattern Dissecting Forceps

Catalog#	Description	Length
PM-0334	Serrated	5" (127 mm)



PM-0334

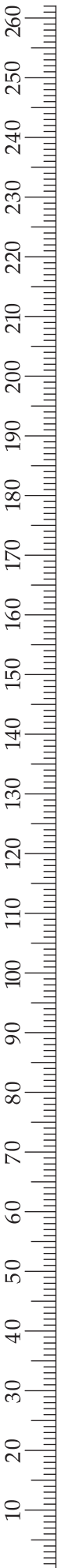

### Braithwaite Dissecting Forceps

Catalog#	Description	Length
PM-0292	1x2 Teeth on Serrated and Grooved Tips	5-1/2" (140 mm)



PM-0292

### Lister Dissecting Forceps

Catalog#	Description	Length
PM-0326	1x2 Teeth on Block with Longitudinally Grooved Tips	4" (102 mm)



PM-0326

### Debakey Atraumatic Tissue Forceps

Catalog#	Description	Length	Jaws
24-550*	-	6" (152 mm)	2.5 mm Wide
24-552*	-	7-3/4" (197 mm)	2.5 mm Wide
24-554*	-	9-1/2" (241 mm)	2.5 mm Wide
24-570*	-	6" (152 mm)	1.5 mm Wide
24-570XL*	Fenestrated Handles	6" (152 mm)	1.5 mm Wide
24-572*	-	8" (203 mm)	1.5 mm Wide
24-574*	-	9-1/2" (241 mm)	1.5 mm Wide



24-550

\*Miltex® Brand

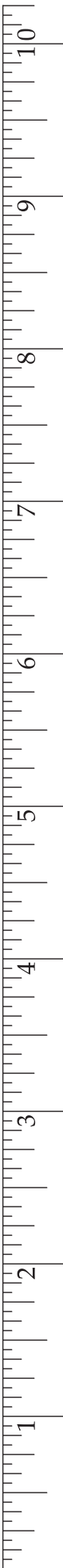

### Von Graefe Tissue Forceps

Catalog#	Description	Length
----------	-------------	--------

PM-6200	Fine Multiple Atraumatic Teeth	4 1/4" (108 mm)
---------	--------------------------------	-----------------

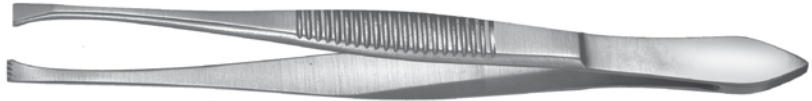

PM-6200

### Nelson Tissue Forceps

Catalog#	Description	Length
----------	-------------	--------

PM-6190	6x7 Teeth	6" (152 mm)
PM-6195	6x7 Teeth	7" (178 mm)



PM-6195

### Sheen Gripping Forceps

Catalog#	Description	Length
----------	-------------	--------

PM-6290	With Pins	5" (127 mm)
---------	-----------	-------------



PM-6290

### Pollock-Dingman Utility Forceps

Catalog#	Description	Length
----------	-------------	--------

PM-555	2x3 Teeth	5-1/2" (140 mm)
--------	-----------	-----------------



PM-555



### Cushing Bayonet Tissue Forceps

Catalog#	Description	Length
----------	-------------	--------

6-192\* 1x2 Teeth With Scraper End 7-1/4" (184 mm)

\*Miltex® Brand



6-192

### Cushing-Brown Tissue Forceps

Catalog#	Description	Length
----------	-------------	--------

PM-4266 8x8 Side Grasping Teeth, Bayonet Style 7-1/4" (184 mm)



PM-4266

### Ellenbogen Bayonet Forceps

Catalog#	Description	Length
----------	-------------	--------

PM-4292 1x2 Teeth Crossed Serrated 10-1/4" (260 mm)



PM-4292

### Barsky Ligature Forceps

Catalog#	Description	Length
----------	-------------	--------

PM-0290 Serrated 7" (178 mm)



PM-0290

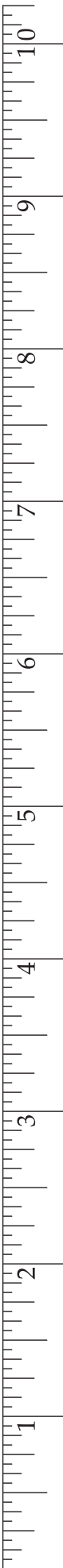



### Cobaugh Eye Dressing Forceps

Catalog#	Description	Length
PM-4213	Serrated	4" (102 mm)



PM-4213

### Bishop-Harmon Iris Dressing Forceps

Catalog#	Description	Length	Jaw
PM-4809	Serrated	3-1/4" (83 mm)	0.6 mm



PM-4809

### Foerster Iris Dressing Forceps

Catalog#	Description	Length
18-795*	Octagonal Grip, Straight, Serrated, 0.5 mm wide	3-3/4" (95 mm)
18-795A*	Octagonal Grip, Full Curve, Serrated, 0.5 mm wide	3-3/4" (95 mm)



\*Miltex® Brand

18-795A

### Thackray Dental Packing Forceps

Catalog#	Description	Length
----------	-------------	--------

PM-0300	Serrated, Angled	6" (152 mm)
---------	------------------	-------------



PM-0300

### Reed Angular Tipped Dressing Forceps

Catalog#	Description	Length
----------	-------------	--------

PM-6140	Serrated	5-1/2" (140 mm)
---------	----------	-----------------



PM-6140

### Jansen Bayonet Dressing Forceps

Catalog#	Description	Length
----------	-------------	--------

PM-4278	Serrated	6-1/2" (165 mm)
PM-4279	Serrated	7-1/2" (191 mm)



PM-4278

### Lucae Bayonet Dressing Forceps

Catalog#	Description	Length
----------	-------------	--------

19-370*	Serrated	5-1/2" (140 mm)
---------	----------	-----------------

\*Miltex® Brand



19-370

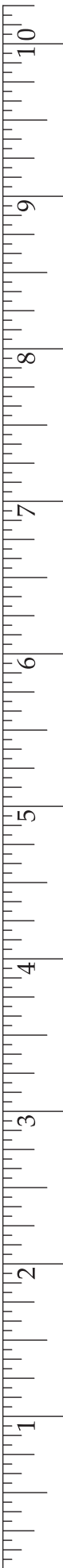



### Gruenwald Dressing Forceps

Catalog#	Description	Length
----------	-------------	--------

PM-4283	Bayonet Style, Serrated	8-1/2" (216 mm)
---------	-------------------------	-----------------



PM-4283

### Jacobson Bayonet Forceps

Catalog#	Description	Length
----------	-------------	--------

PM-4959	Needle Point	6-1/4" (159 mm)
---------	--------------	-----------------



PM-4959

### Wilde Dressing Forceps

Catalog#	Description	Length
----------	-------------	--------

19-350*	Angular Handles, Serrated	5" (127 mm)
20-120*	Angular Handles, Serrated	6-1/2" (165 mm)

\*Miltex® Brand



19-350



### Desmarres Chalazion Forceps

Catalog#	Description	Inside Ring Diameter	Length
18-1200*	Small	17 mm x 11 mm	3-1/2" (89 mm)
18-1202*	Medium	23 mm x 12 mm	3-1/2" (89 mm)
18-1204*	Large	28 mm x 17 mm	3-1/2" (89 mm)

\*Miltex® Brand



18-1202

### Ear Lobe Forceps

Catalog#	Description	Inside Ring Diameter	Length
PM18-1220	With Set Screw	8 mm x 10 mm	3-1/2" (89 mm)



PM18-1220

### Cottle Columella Forceps

Catalog#	Length	Jaw
21-440*	4-1/2" (114 mm)	10 mm Wide

\*Miltex® Brand



21-440

### Berke Ptosis Forceps

Catalog#	Description	Length	Jaw
PM-4323	Longitudinal Serrations with Slide Lock	4" (102 mm)	20 mm
18-1138*	Longitudinal Serrations with Slide Lock	4" (102 mm)	27 mm

\*Miltex® Brand

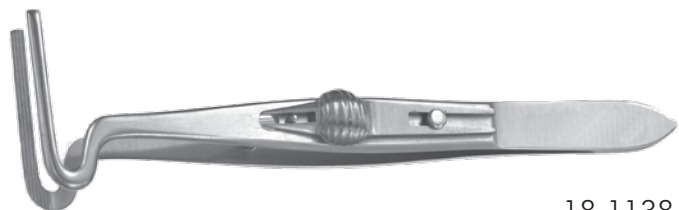

18-1138

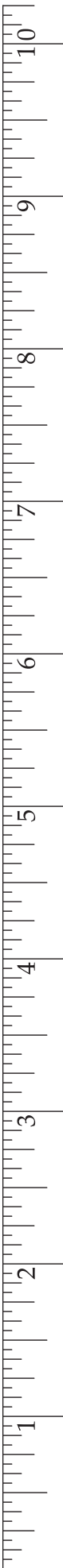

### Converse (Green) Fixation Forceps

Catalog#	Length	Jaw
PM-4240	4" (102 mm)	5 mm
PM-4241	4" (102 mm)	10 mm
PM-4242	4" (102 mm)	13 mm

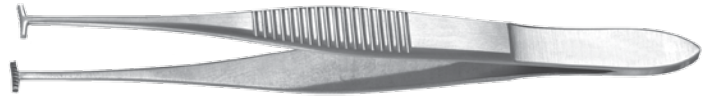

PM-4240

### Castroviejo Suture Forceps

Catalog#	Description	Length	Tip
PM-3726	Wide Handle, 1x2 Delicate Teeth with Tying Platform	4-1/4" (108 mm)	0.3 mm
PM-3727	Wide Handle, 1x2 Delicate Teeth with Tying Platform	4-1/4" (108 mm)	0.9 mm
PM-3731	Wide Handle, 1x2 Delicate Teeth with Tying Platform	4-1/4" (108 mm)	1.5 mm
PM-4908	Wide Handle, 1x2 Delicate Teeth with Tying Platform	4-1/4" (108 mm)	0.5 mm
PM-4909	Narrow Handle, 1x2 Delicate Teeth with Tying Platform	4" (102 mm)	0.5 mm



PM-4909

### Mustarde Combined Dissecting and Suture Holding Forceps

Catalog#	Description	Length
PM-0336	Double Hooked Tips with Longitudinally Serrated Raised Blocks	6" (152 mm)



PM-0336

### Mustarde Suture Removal Forceps

Catalog#	Description	Length
PM-0337	Longitudinally Serrated	5" (127 mm)



PM-0337

### Kurth Suture Forceps

Catalog#	Description	Length	Jaw
----------	-------------	--------	-----

PM-4136	Smooth	4" (102 mm)	8.5 mm
---------	--------	-------------	--------



PM-4136

### Walter Splinter Forceps

Catalog#	Description	Length
----------	-------------	--------

6-312*	Straight, Serrated	4-1/4" (108 mm)
6-314*	Curved, Serrated	4-1/4" (108 mm)



\*Miltex® Brand

6-312

### Howard Splinter Forceps

Catalog#	Description	Length
----------	-------------	--------

6-300*	Straight	3-1/2" (89 mm)
6-302*	Straight	4" (102 mm)
6-304*	Straight	4-1/2" (114 mm)

\*Miltex® Brand



6-300

### Grant (Feilchenfeld) Splinter Forceps

Catalog#	Description	Length
----------	-------------	--------

6-316*	Serrated and Grooved	3" (76 mm)
6-318*	Serrated and Grooved	4-1/2" (114 mm)

\*Miltex® Brand



6-316

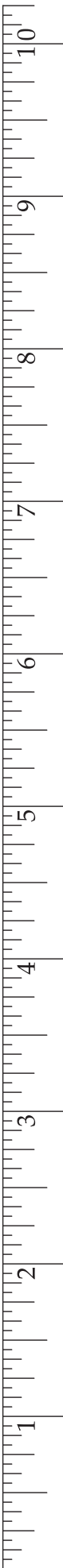



### Micro Suture Forceps

Catalog#	Description	Length
PM-4859	Straight with Tying Platform, 0.3 mm Wide	4-3/4" (121 mm)
PM-4860	Straight with Tying Platform, 0.3 mm Wide	6" (152 mm)



PM-4859

### Micro Forceps (Jeweler's Forceps)

Catalog#	Description	Length
17-301*	Style 1, Fine Points	4-3/4" (121 mm)

\*Miltex® Brand



17-301

### Micro Forceps (Jeweler's Forceps)

Catalog#	Description	Length
17-303*	Style 3, Extra Fine Points	4-3/4" (121 mm)

\*Miltex® Brand

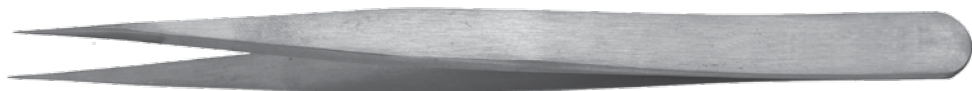

17-303

### Micro Forceps (Jeweler's Forceps)

Catalog#	Description	Length
17-303C*	Style 3C, Extra Fine Points	4-3/8" (112 mm)

\*Miltex® Brand



17-303C

### Micro Forceps (Jeweler's Forceps)

Catalog#	Description	Length
----------	-------------	--------

17-304\* Style 4, Fine Tapered Points 4-3/8" (112 mm)



\*Miltex® Brand

17-304

### Micro Forceps (Jeweler's Forceps)

Catalog#	Description	Length
----------	-------------	--------

17-305\* Style 5, Extra Fine Tapered Points 4-3/8" (112 mm)



\*Miltex® Brand

17-305

### Micro Forceps (Jeweler's Forceps)

Catalog#	Description	Length
----------	-------------	--------

17-307\* Style 7, Fine Points, Curved 4-1/2" (114 mm)

17-307X\* Style 7X, Extra Fine Points, Curved 4-1/2" (114 mm)



\*Miltex® Brand

17-307

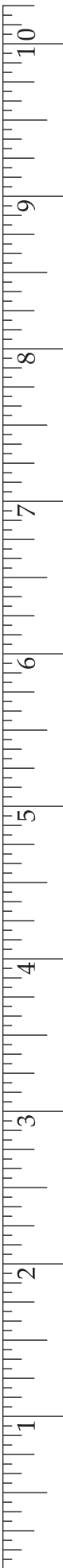

**Micro Forceps (Jeweler's Forceps)**

Catalog#	Description	Length
----------	-------------	--------

17-302*	Style 2, Strong Tapered Fine Points	4-3/4" (121 mm)
---------	-------------------------------------	-----------------



\*Miltex® Brand

17-302

**Micro Forceps (Jeweler's Forceps)**

Catalog#	Description	Length
----------	-------------	--------

PM-4746	Style 0, Delicate Pattern, Fine Points	4-1/2" (114 mm)
---------	--	-----------------



PM-4746

**Micro Forceps (Jeweler's Forceps)**

Catalog#	Description	Length
----------	-------------	--------

PM-4749	Style 26-SA, Fine Points	5-1/4" (133 mm)
---------	--------------------------	-----------------



PM-4749

**Micro Forceps (Jeweler's Forceps)**

Catalog#	Description	Length
----------	-------------	--------

PM-4928	Angled	4-1/2" (114 mm)
---------	--------	-----------------



PM-4928



# Tip-It™ Instrument Protectors

Tip-It™ Instrument Protectors guard instrument tips and edges from damage during handling and sterilization.

- PVC medical grade plastic
- Latex-free material
- Large holes (vented styles) to reduce vacuum and moisture build up for easy removal from instrument
- Steam and gas sterilizable
- 50 per pack

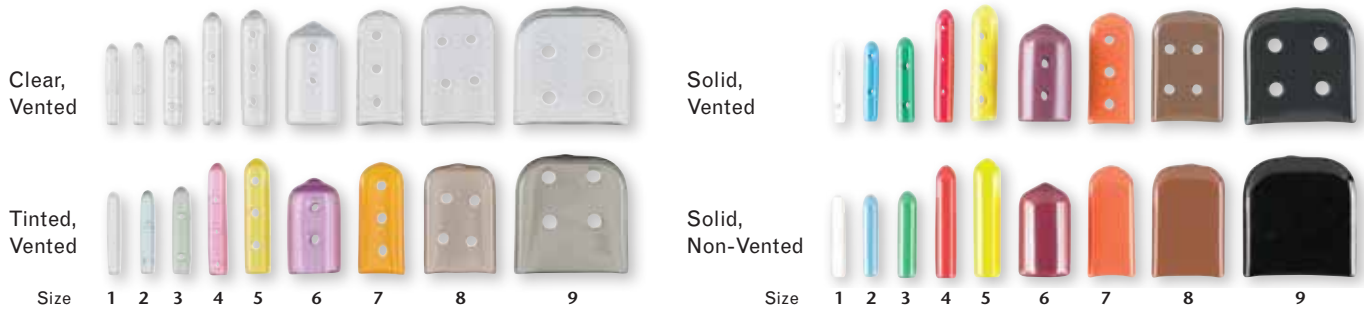

Catalog# Clear Vented	Catalog# Tinted Vented	Catalog# Solid Vented	Catalog# Solid Non-Vented		Size Code	Color
3-2501C	3-2501T	3-2501V	3-2501	1/16" x 3/4" (1.6 mm x 19 mm)	1	White*
3-2502C	3-2502T	3-2502V	3-2502	5/64" x 3/4" (2 mm x 19 mm)	2	Blue*
3-2503C	3-2503T	3-2503V	3-2503	7/64" x 3/4" (2.8 mm x 19 mm)	3	Green*
3-2504C	3-2504T	3-2504V	3-2504	1/8" x 1" (3.2 mm x 25.4 mm)	4	Red*
3-2505C	3-2505T	3-2505V	3-2505	3/16" x 1" (4.8 mm x 25.4 mm)	5	Yellow*
3-2506C	3-2506T	3-2506V	3-2506	13/32" x 3/4" (10.3 mm x 19 mm)	6	Maroon*
3-2507C	3-2507T	3-2507V	3-2507	1/16" x 3/8" x 1" (1.6 mm x 9.5 mm x 25.4 mm)	7	Orange*
3-2508C	3-2508T	3-2508V	3-2508	5/64" x 5/8" x 1" (2 mm x 16 mm x 25.4 mm)	8	Brown*
3-2509C	3-2509T	3-2509V	3-2509	1/8" x 1" x 1" (3.2 mm x 25.4 mm x 25.4 mm)	9	Black*
3-2510C	3-2510T	3-2510V	3-2510	Assorted, equal number of sizes plus 5	-	-

\* Color does not apply to clear vented pattern

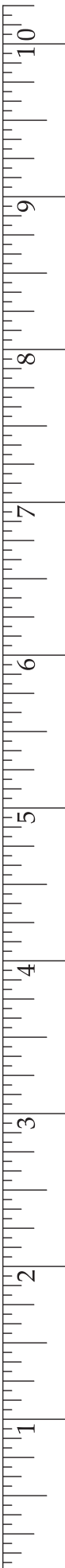

### Adson Bipolar Forceps

Catalog#	Length	Tip
PM-9410	4-1/4" (108 mm)	Needle
PM-9411	4-1/4" (108 mm)	0.5 mm
PM-9412	4-1/4" (108 mm)	1 mm



PM-9411

### Jeweler's Bipolar Forceps

Catalog#	Length	Tip
PM-9420	4-1/2" (114 mm)	Needle
PM-9421	4-1/4" (108 mm)	0.5 mm
PM-9425	4-3/4" (121 mm)	Curved, 0.5 mm



PM-9421

### Bayonet Bipolar Forceps

Catalog#	Length	Tip
PM-9430	6-1/2" (165 mm)	0.5 mm
PM-9431	6-1/2" (165 mm)	1 mm
PM-9435	7-1/2" (191 mm)	0.5 mm
PM-9436	7-1/2" (191 mm)	1 mm



PM-9430

### Potts-Smith Bipolar Forceps

Catalog#	Length	Tip
PM-9440	7-1/4" (184 mm)	1 mm



PM-9440



### Cushing Bipolar Forceps

Catalog#	Description	Length	Tip
----------	-------------	--------	-----

PM-9445 Bayonet Style 7-1/2" (191 mm) 1 mm



PM-9445

### Dowden-Kirn Endoscopic Bipolar Forceps

Catalog#	Description	Length	Tip
----------	-------------	--------	-----

PM-9472 Curved 7" (178 mm) 2 mm Blunt



PM-9472

### Hardy Bayonet Bipolar Irrigating Forceps

Catalog#	Length	Tip
----------	--------	-----

PM-9475 8-1/4" (210 mm) 0.5 mm



PM-9475

### Bipolar Cords

Catalog#	Description	Length
----------	-------------	--------

PM-9450 Silicone, Autoclavable 10' (305 cm)

PM-9450D Sterile, Disposable, 10/Box 12' (360 cm)

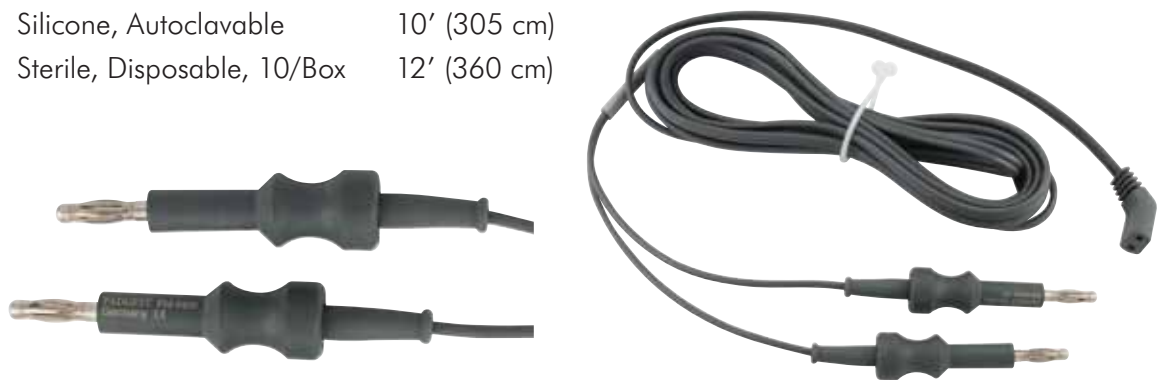

PM-9450

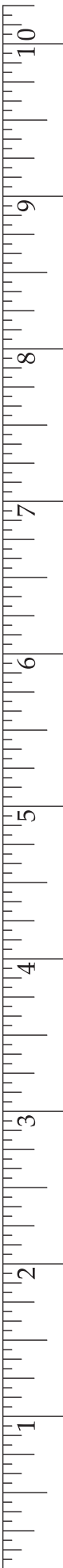

### Allis Tissue Forceps

Catalog#	Description	Length	Jaw
16-3*	Extra Delicate, 4x5 Teeth	5" (127 mm)	2.5 mm Wide
16-4*	Delicate, 4x5 Teeth	5-1/2" (140 mm)	4 mm Wide



16-4

\*Miltex® Brand

### Lahey Forceps

Excellent for securely gripping undermined flaps during rhytidectomy or scalp reduction procedures.

Catalog#	Description	Length	Jaw
12-80*	3x3 Teeth	6-1/4" (159 mm)	8 mm



12-80

\*Miltex® Brand

### Raney Clip Applying Forceps

Catalog#	Length
26-590*	6-1/4" (159 mm)

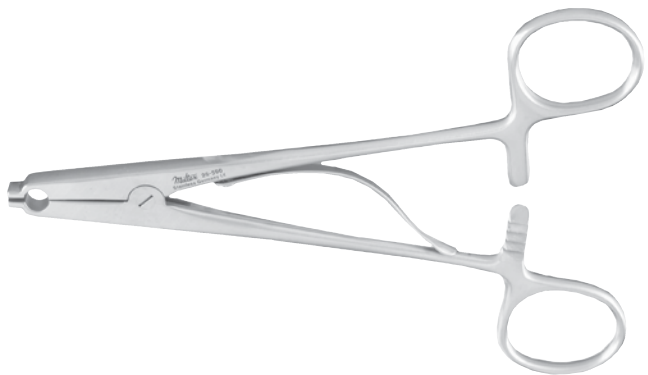

26-590

\*Miltex® Brand

### Raney Clips (Reusable)

Ideal for controlling bleeding during scalp procedures.

Catalog#	Description
26-591*	Black Finish 12 per Package



26-591

\*Miltex® Brand



### Pitanguy Flap Grasping Forceps

For gripping and retraction of undermined skin flaps during rhytidectomy, abdominoplasty or corneal brow lift procedures

Catalog#	Length	Jaw
PM-4321	5-1/2" (140 mm)	15 mm Wide

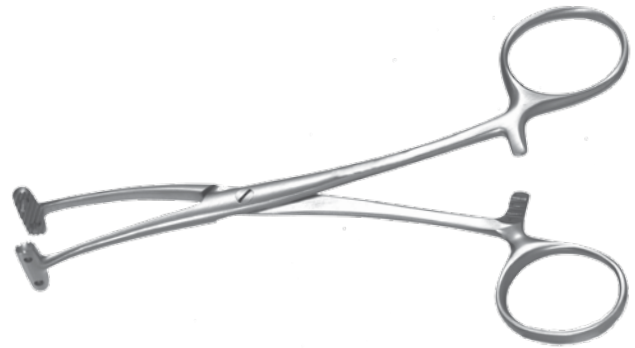

PM-4321

### Bunnell Bone Holding Forceps

Catalog#	Length	Width
PM-3738	7" (178 mm)	5 mm



PM-3738

### Dingman Improved Bone Holding Clamp

Upper jaw is slotted for drilling. Lower jaw is solid to prevent drill from damaging soft tissue. Great for mandibular, maxillofacial and other plastic or reconstructive procedures.

Catalog#	Description	Length
PM-405	Heavy with Curved Shanks	7-1/2" (191 mm)



PM-405





### Simal Rib Forceps

Catalog#	Length
----------	--------

PM-7655	7-3/4" (197 mm)
---------	-----------------

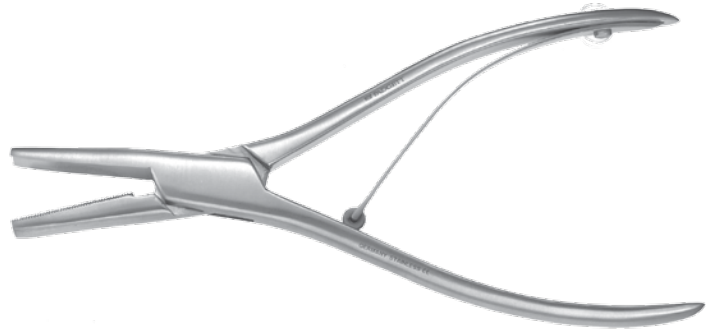

PM-7655

### Asch Septum Straightening Forceps

Catalog#	Description	Length	Jaw
----------	-------------	--------	-----

PM-8210	Angled Blades	9" (229 mm)	44 mm x 7 mm
---------	---------------	-------------	--------------



PM-8210

### Walsham Septum Straightening Forceps

Catalog#	Description	Length	Flat Jaw	Concave Jaw
----------	-------------	--------	----------	-------------

PM-8220	Set of Three			
PM-8221	Left Only	9" (229 mm)	33 mm x 7 mm	33 mm x 9.5 mm
PM-8222	Right Only	9" (229mm)	33 mm x 7 mm	33 mm x 9.5 mm
PM-8223	Universal	9" (229 mm)		33 mm x 10 mm



PM-8221

### Krugel Flap Grasping Forceps

Catalog#	Length	Jaw
----------	--------	-----

PM-4322	9-3/4" (248 mm)	54 mm
---------	-----------------	-------



PM-4322

### Brand Tendon Tunnelling Forceps

Catalog#	Description	Length
----------	-------------	--------

PM-200	Straight, 1x2 Teeth	7" (178 mm)
PM-201	Curved, 1x2 Teeth	7" (178 mm)
PM-202	Straight, 2x3 Teeth	8-1/2" (216 mm)
PM-203	Curved, 2x3 Teeth	8-1/2" (216 mm)



PM-200

### Carroll Tendon Forceps

Catalog#	Description	Length
----------	-------------	--------

27-1016*	Curved Shaft, Alligator Type Jaw	5" (127 mm)
----------	----------------------------------	-------------

\*Miltex® Brand



27-1016

### Larsen Tendon Forceps

Catalog#	Description	Length	Width
----------	-------------	--------	-------

PM-4222	Straight	4" (102 mm)	2 mm Wide
PM-4224	Straight	4" (102 mm)	4 mm Wide
PM-4225	Straight	4" (102 mm)	5 mm Wide



PM-4222

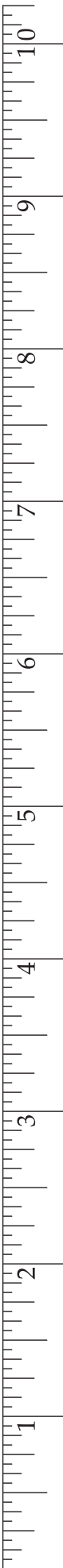

**Brand Tendon Grasping Forceps**

Catalog#    Length

PM-4479    7" (178 mm)



PM-4479

**Amar Mammoplasty Clamp**

Catalog#    Length            Width

PM-8670    6-1/2" (165 mm)    21 mm



PM-8670

**Rowe Maxillary Disimpaction Forceps**

Catalog#    Description    Length

PM-1250R    Right Pattern    9-1/2" (241 mm)

PM-1250L    Left Pattern    9-1/2" (241 mm)



PM-1250R

**Hayton-Williams Forward Traction and Reduction Maxillary Fracture Forceps**

Catalog#    Description            Length

PM-1246    With "Stop" Screw Joint    10" (254 mm)



PM-1246



### Wire Twisting Forceps

Catalog#	Length	Jaw Length
----------	--------	------------

PM-914 5-1/2" (140 mm) 13 mm



PM-914

### House Alligator Ear Forceps, Miniature

Catalog #	Description	Shaft Length	Jaws
19-415*	Extra Delicate, Serrated	2-3/4" (70 mm)	4 mm
19-420*	Straight	2-3/4" (70 mm)	0.6 mm x 1 mm cups
19-421*	Angled Left 15 degrees	2-3/4" (70 mm)	0.6 mm x 1 mm cups
19-422*	Angled Right 15 degrees	2-3/4" (70 mm)	0.6 mm x 1 mm cups
19-2114*	Alligator & Crimper, Very Flat, Tapered Serrated Jaws	2-3/4" (70 mm)	8 mm
19-2117*	Serrated with Side Opening to Right	2-3/4" (70 mm)	6 mm
19-2118*	Oval Cup, Angled Right 15 degrees	2-3/4" (70 mm)	0.9 mm cups
19-2119*	Oval Cup, Angled Left 15 degrees	2-3/4" (70 mm)	0.9 mm cups



19-2114

### Greven Ear Forceps

Catalog #	Shaft Length	Jaws
19-416*	2-3/4" (70 mm)	5 mm jaws with 2.5 mm tips serrated and touching

\*Miltex® Brand



19-416

### Miltex Ear Forceps

Catalog #	Description	Shaft Length	Jaws
19-417*	Extra Fine	2-3/4" (70 mm)	0.9 mm x 2 mm cups
19-418*	Fine	2-3/4" (70 mm)	0.75 mm cups

\*Miltex® Brand



19-417



19-418



19-417

### McGee Ear Crimper/Wire Closure Forceps

Catalog #	Description	Shaft Length	Jaws
19-480*	Short Jaws, Angled Slightly Downward	2-3/4" (70 mm)	3 mm

\*Miltex® Brand



19-480



19-480

### House-Dieters Malleus Ear Nipper

Catalog #	Shaft Length	Jaws
19-481*	3" (76 mm)	2 mm

\*Miltex® Brand



19-481



19-481



### Bellucci Ear Forceps

Catalog #	Description	Shaft Length	Jaws
-----------	-------------	--------------	------

19-2115*	Serrated	3" (76 mm)	8 mm
----------	----------	------------	------

\*Miltex® Brand



19-2115



19-2115

### Goodhill Ear Forceps

Catalog #	Description	Shaft Length	Jaws
-----------	-------------	--------------	------

19-2116*	Serrated	3" (76 mm)	5 mm
----------	----------	------------	------

\*Miltex® Brand



19-2116



19-2116

### Micro Alligator Ear Forceps

Catalog #	Description	Shaft Length	Jaws
-----------	-------------	--------------	------

19-2081*	Serrated	3-1/4" (83 mm)	0.3 mm x 0.7 mm
19-2081-B*	Serrated, Ebony Finish	3-1/4" (83 mm)	0.3 mm x 0.7 mm
19-2090*	Oval Cup	3-1/4" (83 mm)	0.8 mm x 1.09 mm
19-2090-B*	Oval Cup, Ebony Finish	3-1/4" (83 mm)	0.8 mm x 1.09 mm
19-2100*	Serrated	3-1/4" (83 mm)	0.5 mm x 0.9 mm
19-2100-B*	Serrated, Ebony Finish	3-1/4" (83 mm)	0.5 mm x 0.9 mm
19-2110*	Oval Cup	3-1/4" (83 mm)	0.8 mm x 1.17 mm
19-2110-B*	Oval Cup, Ebony Finish	3-1/4" (83 mm)	0.8 mm x 1.17 mm

\*Miltex® Brand



19-2081  
19-2081-B



19-2100  
19-2100-B



19-2090  
19-2090-B



19-2110  
19-2110-B

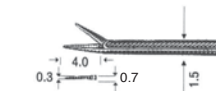

19-2081  
19-2081-B

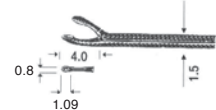

19-2090  
19-2090-B

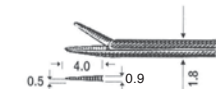

19-2100  
19-2100-B

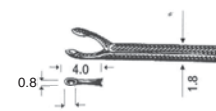

19-2110  
19-2110-B



19-2081

### St. Clair-Thompson Adenoid Forceps

Catalog #	Description	Length	Jaws
-----------	-------------	--------	------

20-929*	Ring Jaws	7-1/4" (184 mm)	5 mm x 10 mm
---------	-----------	-----------------	--------------

\*Miltex® Brand

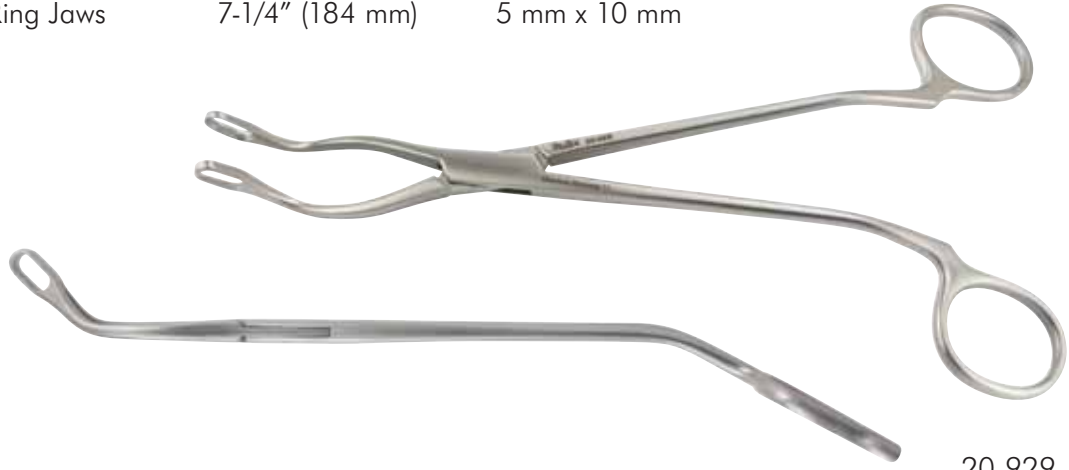

20-929

### King Adenoid Punch Forceps

Catalog #	Description	Shaft Length	Jaws
-----------	-------------	--------------	------

20-930*	Triangular Jaws (No. 1) and strongly curved shaft	4-1/8" (105 mm)	6 mm upper jaw and 7 mm lower basket
---------	---	-----------------	--------------------------------------

\*Miltex® Brand



20-930

### Suction Nasal Forceps

Catalog#	Description	Shaft Length
20-470*	Straight Fenestrated Jaw, Size 1, 4 mm	4" (102 mm)
20-471*	Angled Fenestrated Jaw, Size 1, 4 mm	4" (102 mm)
20-472*	Straight Fenestrated Jaw, Size 0, 3.5 mm	4" (102 mm)
20-473*	Angled Fenestrated Jaw, Size 0, 3.5 mm	4" (102 mm)
20-474*	Straight Fenestrated Jaw, Size 00, 2.5 mm	4" (102 mm)
20-475*	Angled Fenestrated Jaw, Size 00, 2.5 mm	4" (102 mm)
20-476*	Straight Solid Upper Jaw, Size 0, 3.5 mm	4" (102 mm)
20-477*	Angled Solid Upper Jaw, Size 0, 3.5 mm	4" (102 mm)
20-478*	Stylet for Suction Nasal Forceps/Punch Rongeurs	-

\*Miltex® Brand

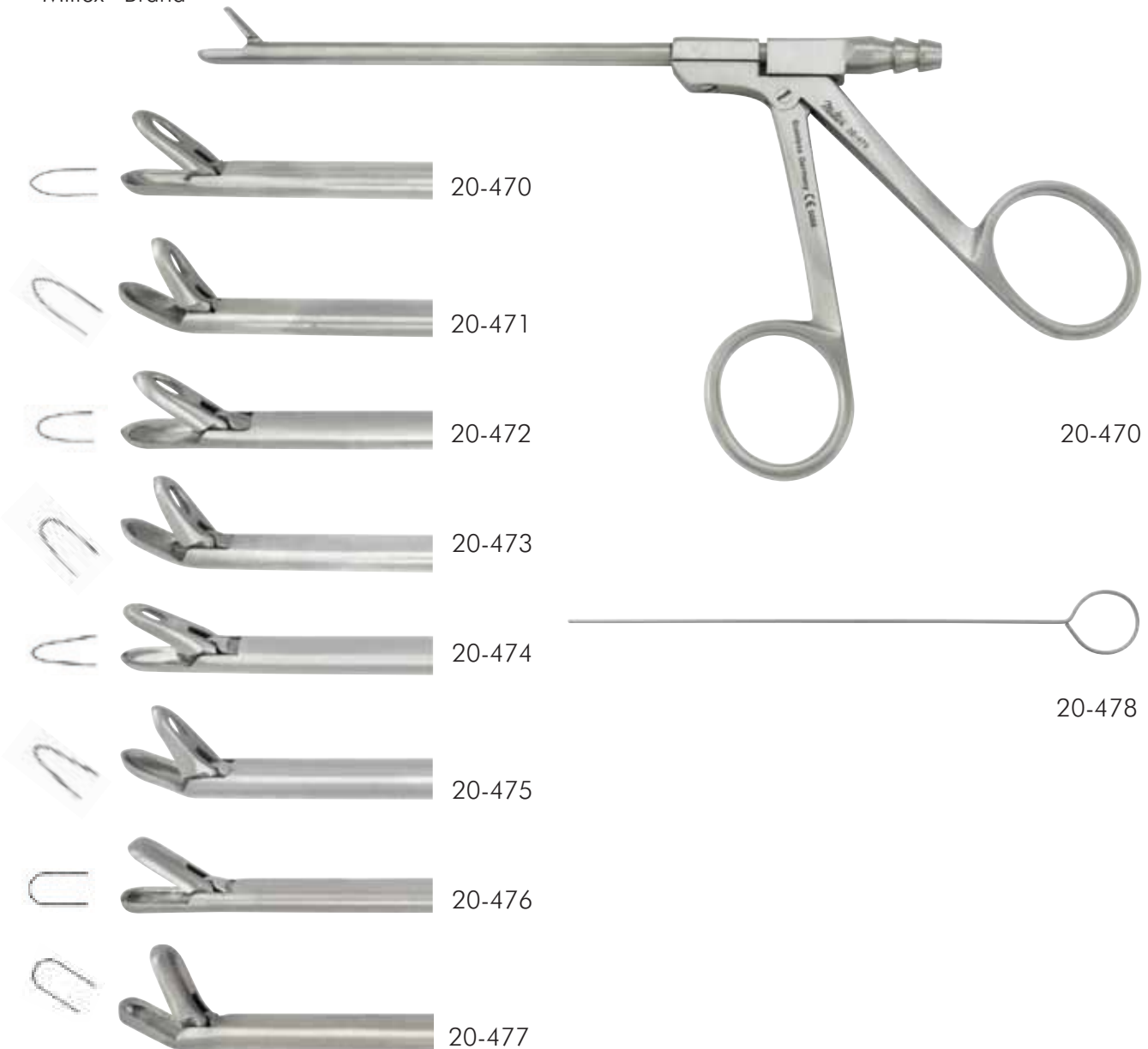

### Blakesley-Wilde Ethmoid Forceps (Fenestrated Cups)

Catalog#	Description	Shaft Length	Cups
20-565*	Pointed Upturned 45 degrees	4-1/4" (108 mm)	4 mm x 10 mm
20-606*	Upturned 45 degrees	4-1/2" (114 mm)	3.5 mm x 10 mm
20-607*	Upturned 45 degrees	4-1/2" (114 mm)	4 mm x 10 mm
20-608*	Upturned 90 degree	4-1/2" (114 mm)	3.5 mm x 10 mm
20-609*	Upturned 90 degree	4-1/2" (114 mm)	4 mm x 10 mm

\*Miltex® Brand



### Ethmoid Forceps, Pediatric

Catalog#	Description	Shaft Length
20-587*	Fenestrated, Straight	3-3/4" (95 mm)
20-588*	Fenestrated, 45 degrees	3-3/4" (95 mm)
20-589*	Fenestrated, 90 degrees	3-3/4" (95 mm)

\*Miltex® Brand



### Wilde Nasal Forceps

Catalog #	Description	Shaft Length	Cups
20-585*	Straight, Fenestrated	4" (102 mm)	5 mm x 10 mm
20-586*	Upturned, Fenestrated	4" (102 mm)	5 mm x 10 mm

\*Miltex® Brand

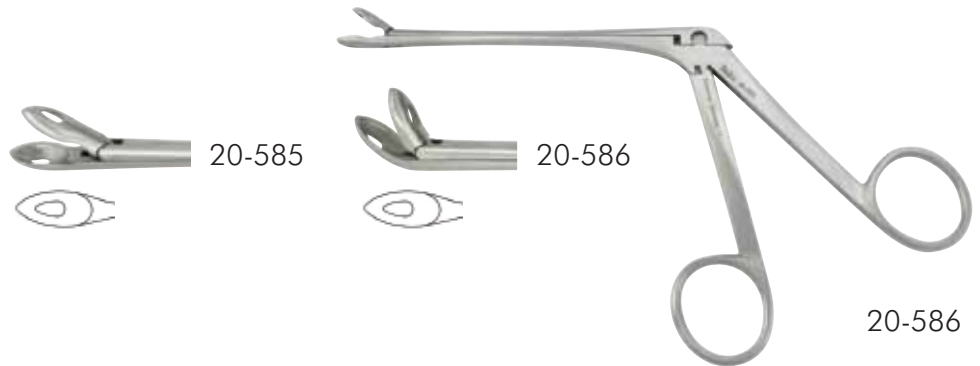

### Blakesley Nasal Forceps

Catalog #	Description	Shaft Length	Cups
20-600*	No. 0, Fenestrated	5-1/2" (140 mm)	3.5 mm x 7 mm
20-601*	No. 1, Fenestrated	5-1/2" (140 mm)	4 mm x 10 mm
20-602*	No. 2, Fenestrated	5-1/2" (140 mm)	4.5 mm x 11 mm

\*Miltex® Brand

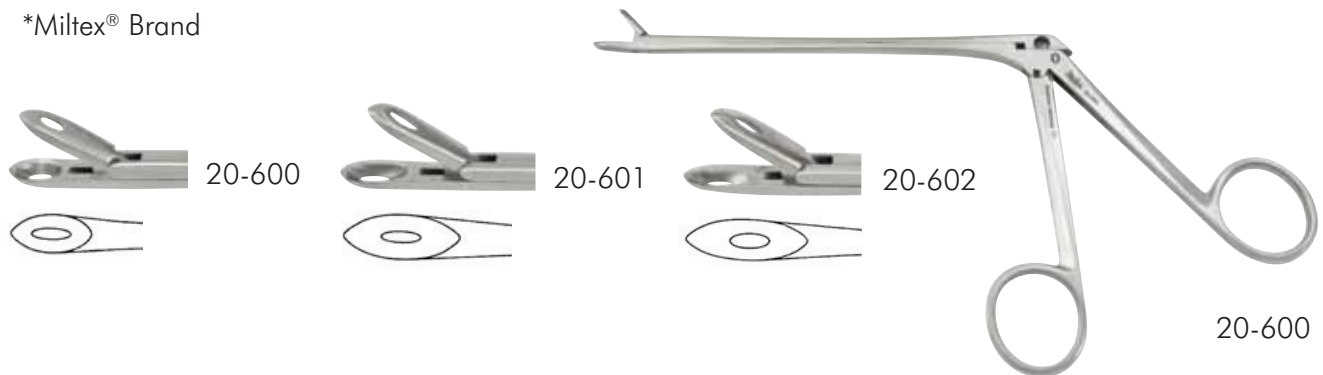

### Miltex Sinus Cup Forceps

Catalog #	Shaft Length	Cups
20-566*	4-1/8" (105 mm)	3 mm cups

\*Miltex® Brand





### Weil Nasal Forceps

Catalog #	Description	Shaft Length
-----------	-------------	--------------

20-567*	Straight, 5 mm x 8 mm	4" (102 mm)
20-568*	Upturned, 5 mm x 8 mm	4" (102 mm)

\*Miltex® Brand



20-567

### Hildyard Post-Nasal Biopsy Forceps

Catalog #	Cups	Shaft Length
-----------	------	--------------

20-605*	3.5 mm cups	4-3/4" (121 mm)
---------	-------------	-----------------

\*Miltex® Brand



20-605

### Weil-Blakesley Through Cutting Forceps

Catalog #	Description	Length	Jaws
-----------	-------------	--------	------











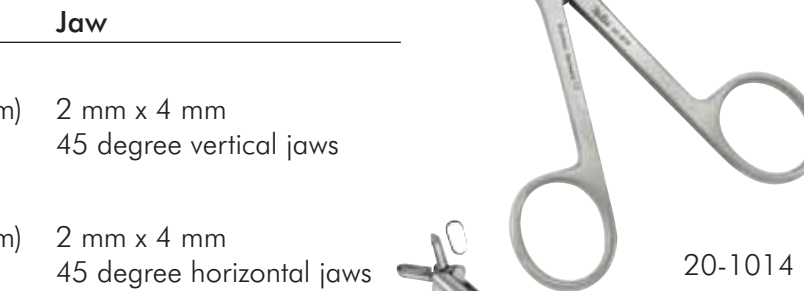





20-712*	Straight	4" (102 mm)	2 mm
20-713*	Straight	4" (102 mm)	2.5 mm
20-714*	Straight	4" (102 mm)	3 mm
20-715*	Up-Angled 45 degree	4" (102 mm)	2 mm
20-716*	Up-Angled 45 degree	4" (102 mm)	2.5 mm
20-717*	Up-Angled 45 degree	4" (102 mm)	3 mm

\*Miltex® Brand

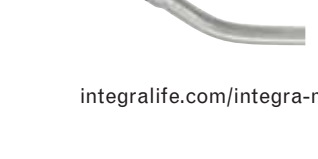

20-712

### Nasal Forceps with Luer Lock Port & Channel

Catalog#	Description	Shaft Length	Jaw	
20-1010*	Frontal Sinus Recess Giraffe Forceps	5 1/2" (140 mm)	2 mm x 4 mm 45 degree vertical jaws	
20-1012*	Frontal Sinus Recess Giraffe Forceps	5 1/2" (140 mm)	2 mm x 4 mm 45 degree horizontal jaws	
20-1014*	Frontal Sinus Recess Giraffe Forceps	5 1/2" (140 mm)	2 mm x 4 mm 90 degree vertical jaws	
20-1016*	Frontal Sinus Recess Giraffe Forceps	5 1/2" (140 mm)	2 mm x 4 mm 90 degree horizontal jaws	
20-1018*	Frontal Sinus Recess Giraffe Forceps	5 1/2" (140 mm)	3 mm x 5 mm 45 degree vertical jaws	
20-1020*	Frontal Sinus Recess Giraffe Forceps	5 1/2" (140 mm)	3 mm x 5 mm 45 degree horizontal jaws	
20-1022*	Biopsy and Grasping Forceps	4 3/4" (121 mm)	3 mm x 5 mm cups 70 degree vertical jaws	
20-1024*	Biopsy and Grasping Forceps	4 3/4" (121 mm)	3 mm x 5 mm cups 70 degree horizontal jaws	
20-1026*	Biopsy and Grasping Forceps	4 3/4" (121 mm)	3 mm x 5 mm cups 110 degree vertical jaws	
20-1028*	Biopsy and Grasping Forceps	4 3/4" (121 mm)	3 mm x 5 mm cups 110 degree horizontal jaws	
20-1030*	Pear Shaped Cup Jaw Forceps	4" (102 mm)	horizontal opening 80 degrees upturned	
20-1032*	Pear Shaped Cup Jaw Forceps	4" (102 mm)	horizontal opening 45 degrees upturned	
				
				
				
				

\*Miltex® Brand

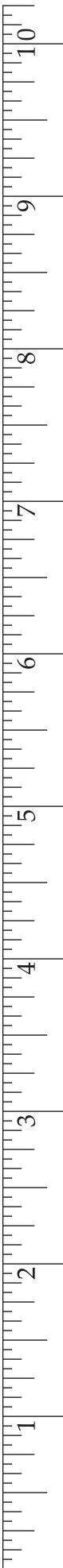



## Nasal Biopsy Forceps, Double-Action with Luer Lock Cleaning Port

Catalog #	Description	Length	Jaws
20-1000*	Straight	6" (152 mm)	3 mm round jaws
20-1002*	70 degrees vertical jaws	6" (152 mm)	3 mm round jaws
20-1004*	70 degrees horizontal jaws	6" (152 mm)	3 mm round jaws
20-1006*	110 degrees vertical jaws	6" (152 mm)	3 mm round jaws
20-1008*	110 degrees horizontal jaws	6" (152 mm)	3 mm round jaws
20-1095*	Luer Lock replacement cap	-	-
20-478*	Stylet for Suction Nasal Forceps and Punch Rongeurs	-	-

\*Miltex® Brand

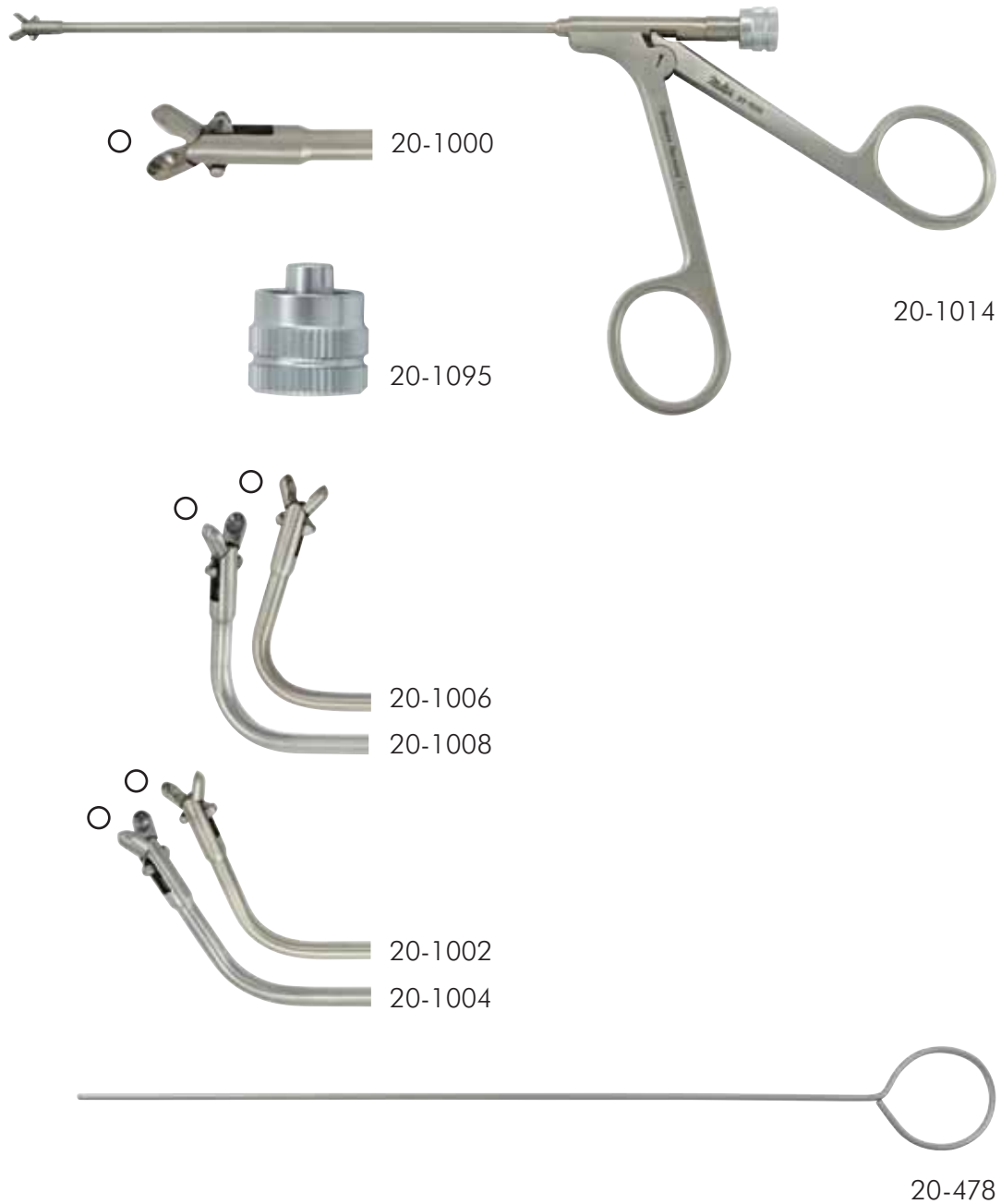



### Nasal Rotating Back-Biting Forceps

Catalog #	Description	Length	Jaws
-----------	-------------	--------	------

20-699*	Adult	7-3/4" (197 mm)	2.5 mm x 7 mm bite
---------	-------	-----------------	--------------------

\*Miltex® Brand



### Antrum Punch Side-Biting Forceps

Catalog #	Description	Length	Jaws
-----------	-------------	--------	------

20-700*	Left	5" (127 mm)	3.5 mm x 8.5 mm bite
20-701*	Right	5" (127 mm)	3.5 mm x 8.5 mm bite

\*Miltex® Brand

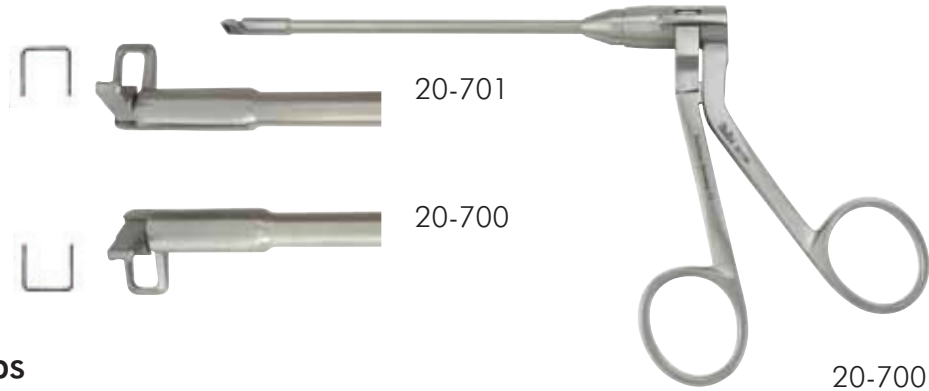

### Antrum Punch Forceps

Catalog #	Description	Shaft Length	Jaws
-----------	-------------	--------------	------

20-702*	45 degree forward biting	5-3/4" (146 mm)	4 mm x 5 mm bite
20-703*	90 degree up-biting	5-1/4" (133 mm)	4 mm x 4 mm bite
20-704*	45 degree backward biting	5-3/4" (146 mm)	4 mm x 5 mm bite
20-705*	90 degree down biting	5-1/4" (133 mm)	4 mm x 4 mm bite

\*Miltex® Brand

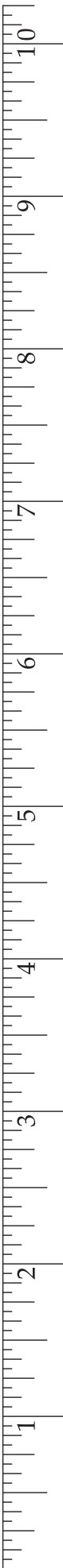

### McKenty Sphenoid Punch Forceps

Catalog #	Description	Shaft Length	Jaws
20-558*	Through-cutting small jaws, reversible, 2 mm footplate depth, angled 85 degrees	5-3/4" (146 mm)	1.5 mm x 4 mm

\*Miltex® Brand

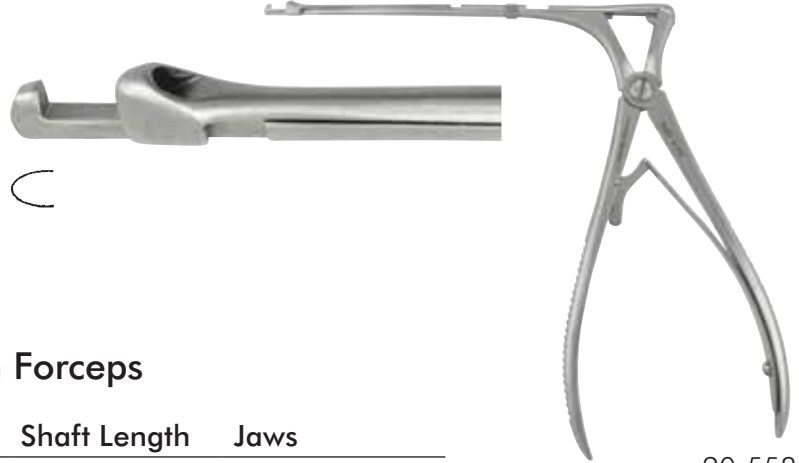

20-558

### Hajek-Kofler Sphenoid Punch Forceps

Catalog #	Description	Shaft Length	Jaws
20-559*	Small solid biting jaws, reversible, original model with fixation nut, 3 mm footplate depth, angled 90 degrees	6" (152 mm)	3 mm x 7 mm

\*Miltex® Brand



20-559

### Hajek-Kofler Sphenoid Punch Forceps

Catalog #	Description	Shaft Length	Jaws
20-560*	Delicate jaws, up and through-cutting, 3 mm footplate depth, angled 85 degrees	6-3/8" (162 mm)	2 mm x 3 mm

\*Miltex® Brand



20-560



### Circular Cutting Punch

Catalog #	Length	Jaws
20-708*	7-5/64" (180 mm)	3.5 mm bite, straight
20-709*	7-5/64" (180 mm)	3.5 mm bite, up 45 degrees
20-710*	7-1/8" (181 mm)	4.5 mm bite, straight
20-711*	7-1/8" (181 mm)	4.5 mm bite, up 45 degrees

\*Miltex® Brand

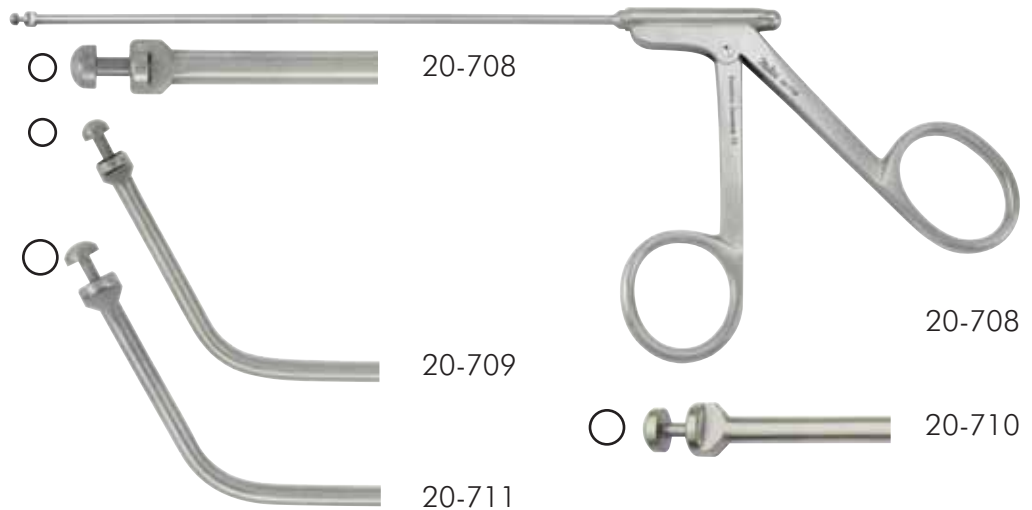

### Ostrum Punch, Back-Biting with Luer Lock Cleaning Port

Catalog #	Description	Length	Jaws
20-1034*	Straight Bite	4-1/8" (105 mm)	2.5 mm x 7 mm bite
20-1036*	Left Bite	4-1/8" (105 mm)	2.5 mm x 7 mm bite
20-1038*	Right Bite	4-1/8" (105 mm)	2.5 mm x 7 mm bite
20-1040*	Pediatric, Straight Bite	4-1/8" (105 mm)	1.5 mm x 7 mm bite
20-1042*	Pediatric, Left Bite	4-1/8" (105 mm)	1.5 mm x 7 mm bite
20-1044*	Pediatric, Right Bite	4-1/8" (105 mm)	1.5 mm x 7 mm bite

\*Miltex® Brand

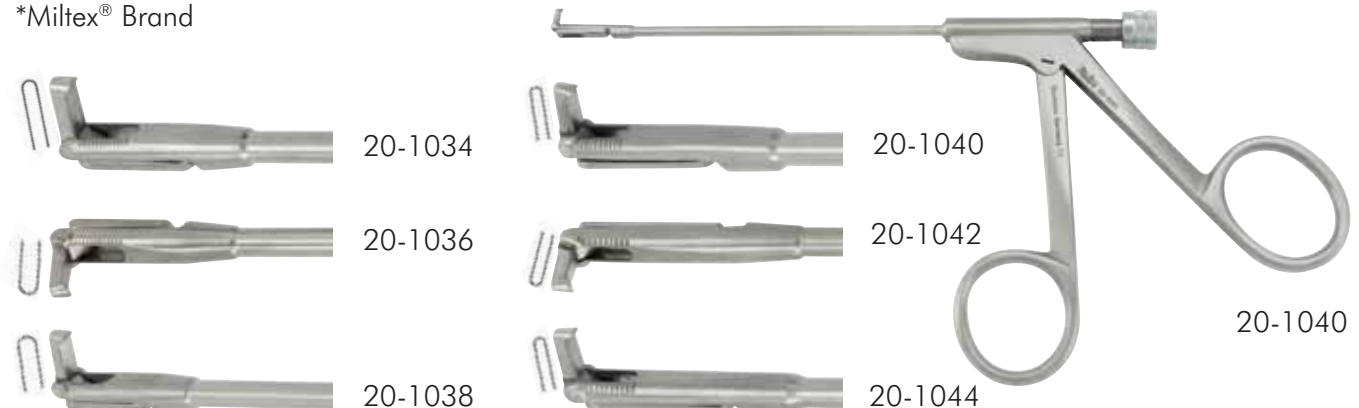

### Kerrison-Costen Rongeur

Catalog #	Description	Shaft Length	Jaws
18-1997*	Curved, 3 mm footplate depth, angled 90 degrees	3-1/4" (85 mm)	4 mm x 9 mm bite,

\*Miltex® Brand



18-1997

### Miltex Punch Rongeur

Catalog #	Shaft Length	Jaws
20-706*	6" (152 mm)	1.5 mm bite
20-707*	6" (152 mm)	2.5 mm bite

\*Miltex® Brand



20-707



### Ferris-Smith Sponge & Fragment Forceps

Catalog#	Description	Shaft Length	Jaw
21-661*	Serrated & Fenestrated Jaws	4-1/8" (105 mm)	8 mm x 6 mm

Great for retrieving bone fragments or nasal cartilage.

\*Miltex® Brand



21-661

### Blakesley (Wilde) Forceps

Catalog#	Description	Shaft Length	Jaw
20-580*	Pointed Fenestrated Cups	5" (127 mm)	11 mm x 3 mm
20-582*	Pointed Fenestrated Cups	5" (127 mm)	12 mm x 4 mm
20-584*	Pointed Fenestrated Cups	5" (127 mm)	13 mm x 5 mm

\*Miltex® Brand



20-580

### Takahashi Nasal Forceps

Slender shafts of varying lengths allow for removal of small fragments or polyps deep in the nasal cavity.

Catalog#	Length	Jaw
20-570*	4-1/2" (114 mm) Shaft	10 mm x 2.5 mm
20-572*	4-1/2" (114 mm) Shaft	10 mm x 4 mm
20-575*	6-3/8" (162 mm) Shaft	10 mm x 2 mm
20-576*	6-3/8" (162 mm) Shaft	10 mm x 3 mm
20-577*	6-3/8" (162 mm) Shaft	10 mm x 4 mm

\*Miltex® Brand



20-570



### Gruenwald Nasal Forceps (Thru-Cutting)

Catalog#	Length	Bite
20-594*	4-1/2" (114 mm) Shaft	10 mm x 2 mm
20-596*	4-1/2" (114 mm) Shaft	10 mm x 2.5 mm
20-598*	4-1/2" (114 mm) Shaft	10 mm x 3 mm

\*Miltex® Brand



20-598

### Jansen-Middleton Septum Forceps

Catalog#	Description	Length	Jaw
20-554*	Solid Spoon Shaped Cup	7-1/2" (191 mm)	15 mm x 5 mm
20-556*	Thru-Cutting Jaws	7-1/2" (191 mm)	19 mm x 4 mm
20-557*	Thru-Cutting Jaws	7-1/2" (191 mm)	14 mm x 4 mm

\*Miltex® Brand



20-554



20-557

### Nigro-Hamra Septum Forceps

Catalog#	Description	Length
PM-4662	Angled Handles, Flat Serrated Jaws	8" (203 mm)
PM-4661	Angled Handles, Flat Serrated Jaws	7-3/8" (187 mm)



PM-4662

## Sheen-Killian Septum Forceps

Great for gripping elusive cartilage and bone fragments during rhinoplasty, osteotomy or nasal reconstruction procedures.

Catalog#	Description	Length
PM-4660	Angled Handles, Flat Serrated Jaws	6-1/2" (165 mm)



## Cottle-Walsham Septum Straightening Forceps

Catalog#	Length	Jaw
PM-8200	9" (229 mm)	33 mm x 7 mm



## Sheen Cartilage Forceps, Bayonet

Designed for cartilage re-insertion after trimming to desired size.

Catalog#	Description	Length	Jaw Width
PM-6295	Oval Fenestrated Jaw	6-1/2" (165 mm)	6 mm

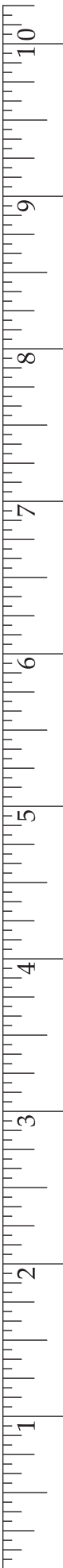

### Fredrick Face Lift Forceps

Catalog#	Description	Length
----------	-------------	--------

7-514*	Can be used as a Non-Perforating Towel Clamp	4" (102 mm)
--------	--	-------------

\*Miltex® Brand

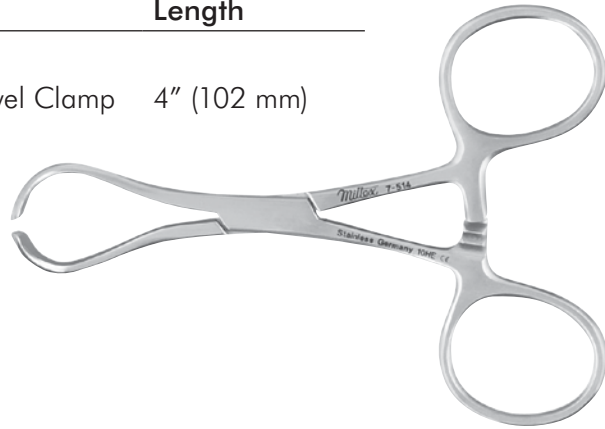

7-514

### Lorna (EDNA) Towel Clamp

Catalog#	Description	Length
----------	-------------	--------

7-514*	Non-Perforating	4" (102 mm)
7-515*	Non-Perforating	5-1/4" (133 mm)

\*Miltex® Brand



7-515

### Backhaus Towel Clamp

Catalog#	Length
----------	--------

7-504*	3-1/2" (89 mm)
7-506*	5-1/4" (133 mm)

\*Miltex® Brand



7-504



### Jones Towel Clamp

Catalog#	Description	Length
7-500*	Cross-Action, Standard Size	3-1/2" (89 mm)
7-501*	Cross-Action, Lightweight Size	2-1/4" (57 mm)

\*Miltex® Brand



7-500

### Johns Hopkins Bulldog Clamp

Catalog#	Description	Length
7-280*	Straight	1-1/2" (38 mm)
7-290*	Curved	1-1/2" (38 mm)
7-282*	Straight	2" (51 mm)
7-292*	Curved	2" (51 mm)

\*Miltex® Brand



7-282

### Halstead Mosquito Forceps

Catalog#	Description	Length
7-2*	Straight	5" (127 mm)
7-4*	Curved	5" (127 mm)
7-20*	Angled 45° on Flat	4-1/2" (114 mm)
7-14*	Straight, 1x2 Teeth	5" (127 mm)
7-16*	Curved, 1x2 Teeth	5" (127 mm)

\*Miltex® Brand



7-2

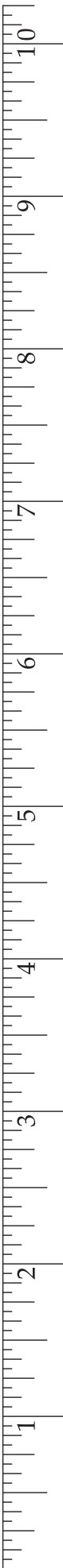

### Hartman Mosquito Forceps

Catalog#	Description	Length
7-24*	Straight	4" (102 mm)
7-26*	Curved	4" (102 mm)

\*Miltex® Brand



7-24

### Padgett Mosquito Forceps

Catalog#	Description	Length
FLM-100	Straight	4" (102 mm)
FLM-105	Curved	4" (102 mm)
FLM-110	Straight, Serrated Jaws and 1x2 Teeth	4" (102 mm)
FLM-115	Curved, Serrated Jaws and 1x2 Teeth	4" (102 mm)
FLM-130	Straight, with Long Serrated Jaws	4-3/4" (121 mm)
FLM-135	Curved, with Long Serrated Jaws	4-3/4" (121 mm)
FLM-120	Straight	5" (127 mm)
FLM-125	Curved	5" (127 mm)
FLM-140	Straight	6" (152 mm)
FLM-145	Curved	6" (152 mm)

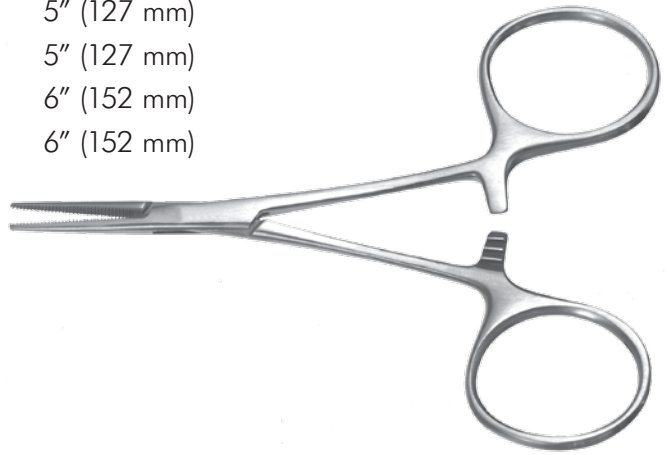

FLM-100

### Providence Hospital Hemostat

Catalog#	Description	Length
7-30*	Straight	5-1/2" (140 mm)
7-32*	Curved	5-1/2" (140 mm)

\*Miltex® Brand



7-32

### Kelly Hemostat

Catalog#	Description	Length
7-36*	Half Serrated Jaws, Straight	5-1/2" (140 mm)
7-38*	Half Serrated Jaws, Curved	5-1/2" (140 mm)

\*Miltex® Brand

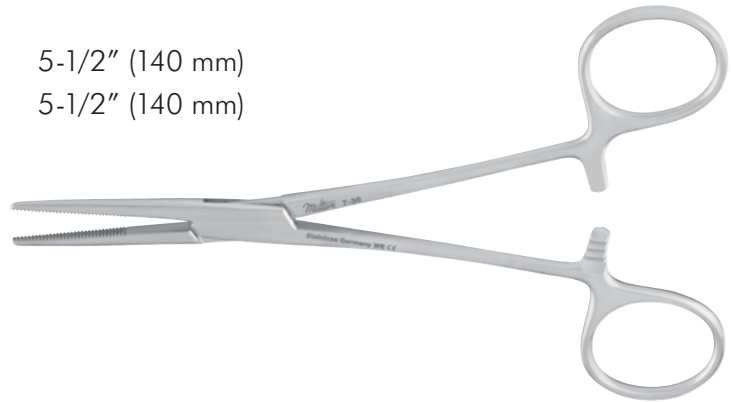

7-36

### Crile Hemostat

Catalog#	Description	Length
7-42*	Full Serrated Jaws, Straight	5-1/2" (140 mm)
7-44*	Full Serrated Jaws, Curved	5-1/2" (140 mm)
7-46*	Full Serrated Jaws, Straight	6-1/4" (159 mm)
7-48*	Full Serrated Jaws, Curved	6-1/4" (159 mm)

\*Miltex® Brand

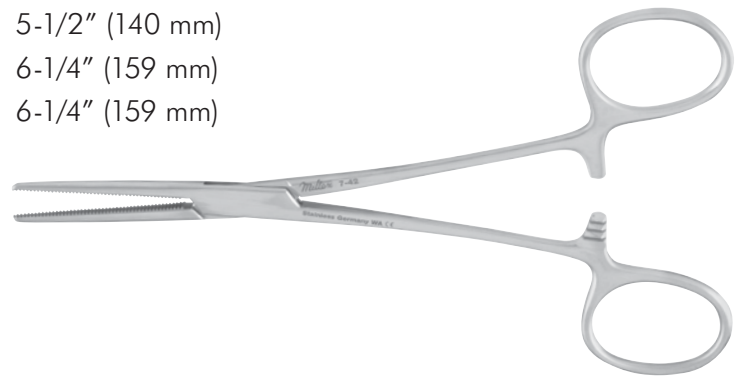

7-42

### Baby-Mixer Forceps

Catalog#	Description	Length
FLM-275	Curved	5-1/2" (140 mm)

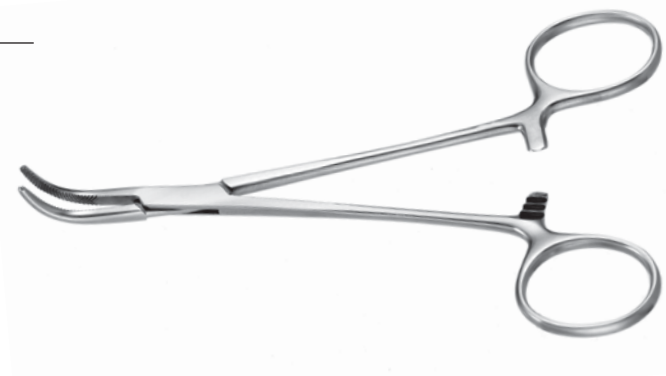

FLM-275

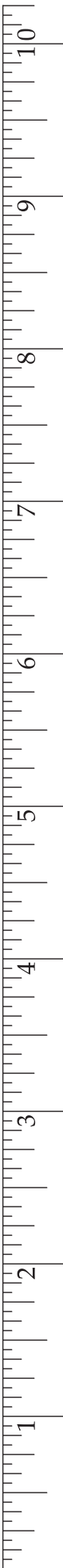

**Kocher Forceps**

Catalog#	Description	Length
7-66*	1x2 Teeth, Straight	5-1/2" (140 mm)
7-68*	1x2 Teeth, Curved	5-1/2" (140 mm)

\*Miltex® Brand



7-66

**Dandy Forceps**

Catalog#	Description	Length
PM-7103	Curved Sideways, cross-serrated	4-3/4" (121 mm)
7-102*	Curved Sideways	5-1/2" (140 mm)

\*Miltex® Brand

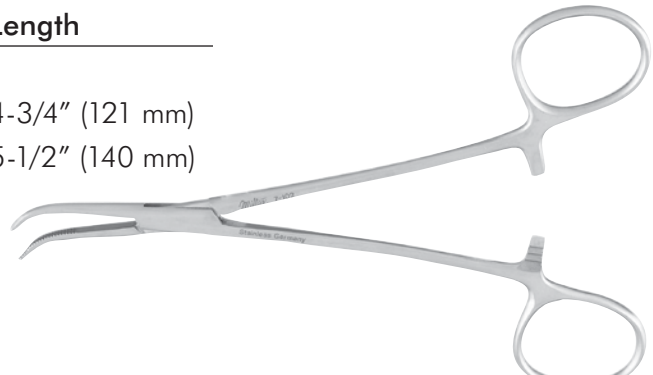

7-102

**Rochester-Pean Forceps**

Catalog#	Description	Length
7-136*	Curved	5-1/2" (140 mm)
7-118*	Straight	5-1/2" (140 mm)

\*Miltex® Brand



7-136

**Rochester-Ochsner Forceps**

Catalog#	Description	Length
7-150*	1x2 Teeth, Straight	6-1/4" (159 mm)
7-160*	1x2 Teeth, Curved	6-1/4" (159 mm)

\*Miltex® Brand



7-150

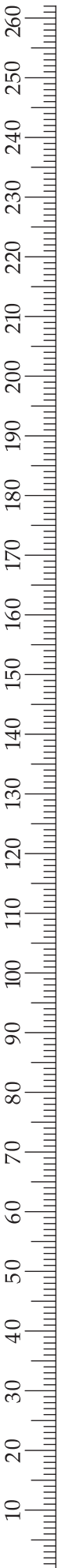

### Rankin Hemostat

Catalog#	Description	Length
----------	-------------	--------

7-92*	Straight	6-1/4" (159 mm)
7-94*	Curved	6-1/4" (159 mm)

\*Miltex® Brand

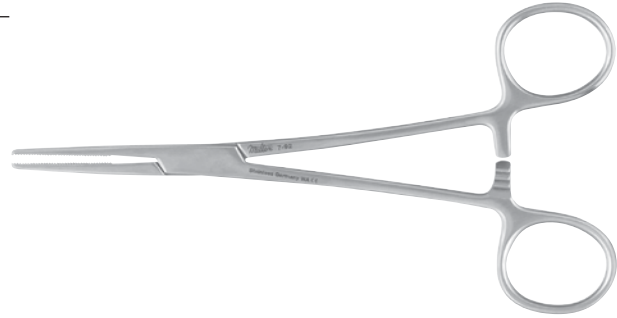

7-92

### Padgett Mosquito Forceps

Catalog#	Description	Length
----------	-------------	--------

PM-8630	Straight, Delicate	7-1/8" (181 mm)
PM-8631	Curved, Delicate	7-1/8" (181 mm)

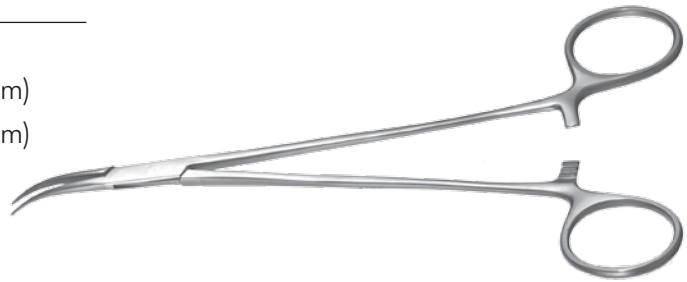

PM-8631

### Adson Hemostat

Catalog#	Description	Length
----------	-------------	--------

7-240*	Straight	7-1/4" (184 mm)
7-242*	Curved	7-1/4" (184 mm)

\*Miltex® Brand



7-240

### Adson Delicate Hemostat

Catalog#	Description	Length
----------	-------------	--------

PM-8625	Delicate, Curved	9-1/4" (235 mm)
PM-8626	Delicate, Curved	7-1/4" (184 mm)



PM-8626

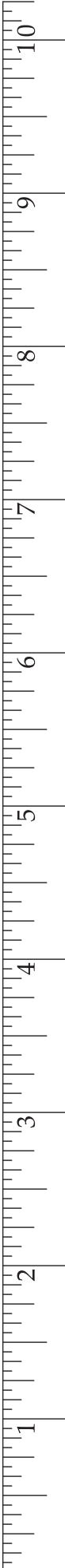

### Lariche Forceps

Catalog#	Description	Length
----------	-------------	--------

PM-8585	Curved	8" (203 mm)
---------	--------	-------------



PM-8585

### Kocher Clamp Forceps

Catalog#	Description	Length	Jaw Length
----------	-------------	--------	------------

PM-0642	Curved with Screw Joint, Longitudinal Serrations	10" (254 mm)	5" (127 mm)
---------	--	--------------	-------------



PM-0642

### Young Tongue Seizing Forceps

Catalog#	Description	Length	Jaw
----------	-------------	--------	-----

2-60*	Forceps	6-1/2" (165 mm)	23 mm x 15 mm
-------	---------	-----------------	---------------

2-62*	Rubber Jaws for 2-60, Set of 2		
-------	--------------------------------	--	--



2-60

\*Miltex® Brand



### Foerster Sponge Holding Forceps

Catalog#	Description	Length
7-606*	Straight, Smooth Jaws	7" (178 mm)
7-604*	Straight, Serrated Jaws	7" (178 mm)
7-602*	Straight, Smooth Jaws	9-1/2" (241 mm)
7-600*	Straight, Serrated Jaws	9-1/2" (241 mm)

\*Miltex® Brand

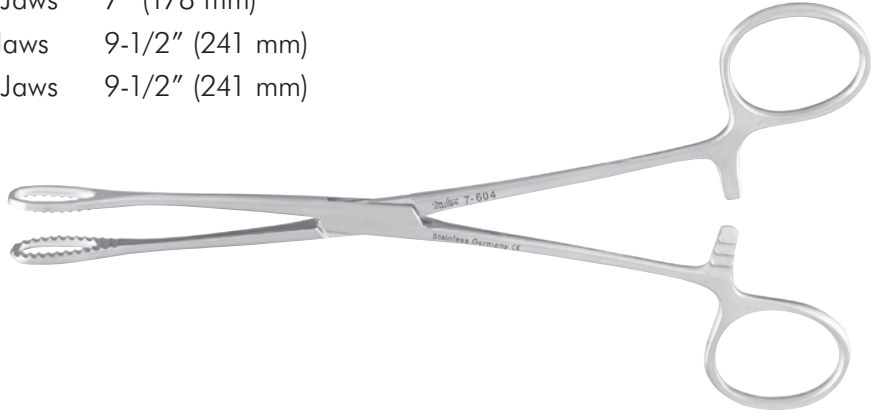

7-604

### Foerster Sponge Holding & Utility Sterilizer Forceps

Catalog#	Description	Length
3-20*	Straight	8" (203 mm)
3-22*	Curved	8" (203 mm)
3-24*	Straight	11" (279 mm)
3-26*	Curved	11" (279 mm)

\*Miltex® Brand

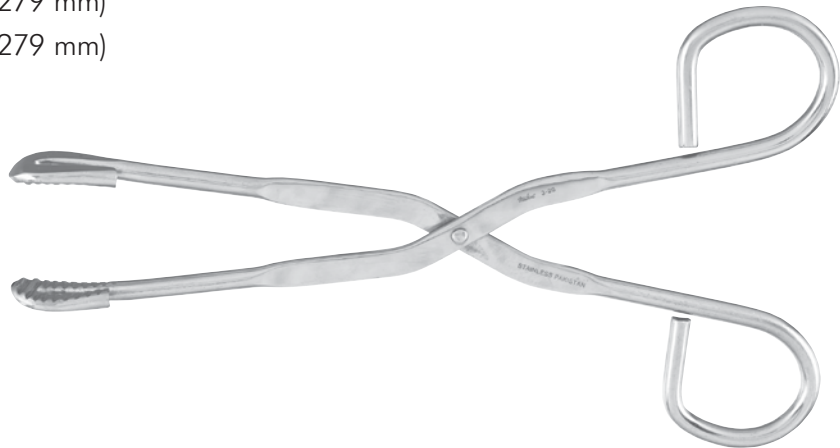

3-20

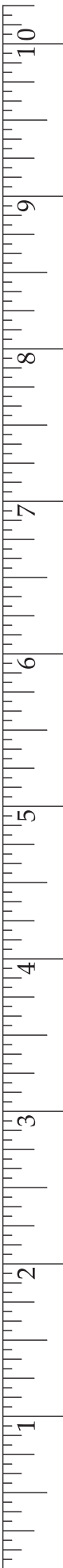

# HOOKS AND RETRACTORS



Hooks  
Retractors  
Mouth Gags  
Oral Retractors  
Specula



### Frazier Hook

Catalog#	Description	Length	Hook
26-1084*	Sharp	5" (127 mm)	5 mm
26-1086*	Blunt	5" (127 mm)	5 mm

\*Miltex® Brand



26-1084

### Tyrell Hook

Catalog#	Description	Length	Hook
18-412*	Sharp	5" (127 mm)	2 mm
18-414*	Blunt	5" (127 mm)	2 mm

\*Miltex® Brand



18-412

### Delicate Skin Hook

Catalog#	Description	Length	Hook
PM-5210	Sharp	5" (127 mm)	4.5 mm
PM-431	Sharp	7" (178 mm)	3.5 mm



PM-5210

### Kilner Skin Hook

Catalog#	Description	Length	Hook
PM-5220	Sharp, Smooth Handle	5" (127 mm)	2.5 mm
PM-0564	Sharp, Detachable Hook, Knurled Handle	6" (152 mm)	2.5 mm
PM-0566	Sharp, Spare Hook for PM-0564	2-3/4" (70 mm)	2.5 mm



PM-5220



PM-0564



PM-0566

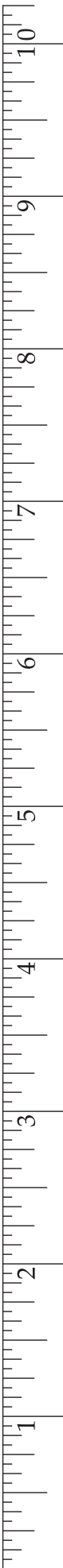

### Guthrie Hook

Catalog#	Description	Length	Width
PM-5225	2 Sharp Prongs	4-3/4" (121 mm)	2.5 mm
PM-5226	2 Sharp Prongs, Delicate	4-3/4" (121 mm)	2 mm
18-416*	2 Sharp Prongs, Extra Delicate	5" (127 mm)	1.5 mm



\*Miltex® Brand

PM-5226

### Joseph Single Prong Hook

Catalog#	Description	Length	Hook
21-153*	Sharp	6-1/4" (159 mm)	5.5 mm



\*Miltex® Brand

21-153

### Joseph Double Prong Hook

Catalog#	Description	Length	Width
21-154*	Sharp	6-1/4" (159 mm)	2 mm
21-156*	Sharp	6-1/4" (159 mm)	5 mm
21-158*	Sharp	6-1/4" (159 mm)	7 mm
21-160*	Sharp	6-1/4" (159 mm)	10 mm
PM-5347	Sharp	6-1/4" (159 mm)	12 mm



\*Miltex® Brand

21-160

### Lewis Delicate Skin Hook

Catalog#	Description	Length	Hook
PM-5448	Sharp Delicate Hook without Bead Stop	5" (127 mm)	2.5 mm



### Carroll Retractor & Hook

Catalog#	Description	Length	Hook
PM-5445	Sharp Delicate Hook with Bead Stop	5" (127 mm)	3 mm



### Palate Hook

Catalog#	Description	Length	Hook
PM-5360	Blunt	8" (203 mm)	8 mm



### Converse (Gillies) Skin Hook

Catalog#	Description	Length	Hook
21-89*	Small, Sharp	7" (178 mm)	2.5 mm
21-88*	Large, Sharp	7" (178 mm)	4 mm



\*Miltex® Brand

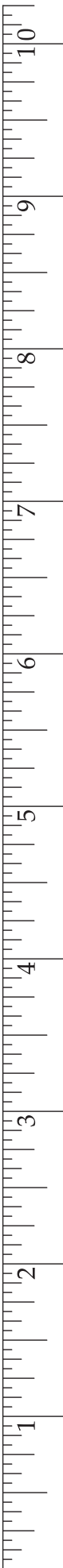

### Kleinert-Kutz Skin Hook

Catalog#	Description	Length	Hook
21-85*	Small, Sharp	5" (127 mm)	3 mm
21-86*	Medium, Sharp	5" (127 mm)	5 mm
21-87*	Large, Sharp	5" (127 mm)	7 mm

\*Miltex® Brand



21-86

### Straight Skin Hook

Catalog#	Description	Length	Hook
PM-5372	Large, Sharp	6" (152 mm)	5 mm



PM-5372

### Converse Skin Hook

Catalog#	Description	Length	Hook
PM-500A	Small, Sharp, Aluminum Handle	6" (152 mm)	3 mm
PM-500B	Medium, Sharp, Aluminum Handle	6" (152 mm)	4 mm
PM-500C	Large, Sharp, Aluminum Handle	6" (152 mm)	5 mm



PM-500A

### Straight Skin Hook

Catalog#	Description	Length	Hook
PM-500D	Large, Sharp, Aluminum Handle	6" (152 mm)	5 mm
PM-500E	Small, Delicate, Sharp, Aluminum Handle	6" (152 mm)	2.5 mm



PM-500D



### Nasal Tenaculum Hook

Catalog#	Description	Length	Width
PM-501A	2 Sharp Prongs, Aluminum Handle	6-1/4" (159 mm)	6 mm
PM-501B	2 Sharp Prongs, Aluminum Handle	6-1/4" (159 mm)	7 mm



PM-501B

### Guthrie Hook (Long Pattern)

Catalog#	Description	Length	Width
PM-501E	2 Sharp Prongs	6" (152 mm)	2.5 mm



PM-501E

### Freeman Skin Hook

Catalog#	Description	Length	Hook
PM-502A	Single Sharp Hook	4" (102 mm)	5 mm
PM-502B	Double Sharp Hook	4" (102 mm)	5 mm



PM-502A

### Mammoplasty or Mastectomy Hook

Catalog#	Description	Length	Hook
PM-503	Extra Large, Sharp	7-1/2" (191 mm)	10 mm



PM-503

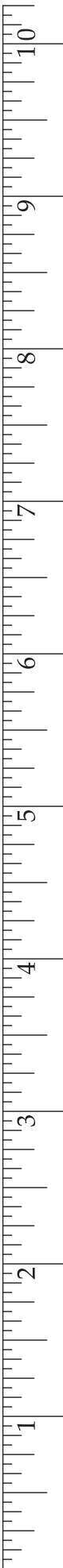

## Gillies Skin Hook

Ideal for manipulating skin edges

Catalog#	Description	Length	Hook
PM-0536	Sharp, Small	7" (178 mm)	2.5 mm
PM-5215	Sharp, Medium	7-1/2" (191 mm)	2.9 mm
PM-0538	Sharp, Large and Strong	7" (178 mm)	5 mm



PM-0536

## Clodius Fish Hook Retractor with Chain

Catalog#	Description	Hook
PM-504A	Small	7 mm
PM-504B	Large	12 mm



PM-504B

## Millard Thumb Single Hook

Catalog#	Description	Hook
PM-506	Standard	5 mm



PM-506

\*Miltex® Brand



### Millard Thumb Double Hook

Catalog#	Description	Width
PM-507	Standard	17 mm
PM-507W	Same as PM-507 for Women Surgeons	17 mm



PM-507

### Millard Thimble Hook

Catalog#	Description	Hook
21-107*	5/8" (16 mm) working length	5.2 mm

\*Miltex® Brand



21-107

### Cottle Thumb Hook

Catalog#	Description	Width
21-108*	Sharp Double Hook 1-1/2" (38 mm) working length	8 mm

\*Miltex® Brand



21-108

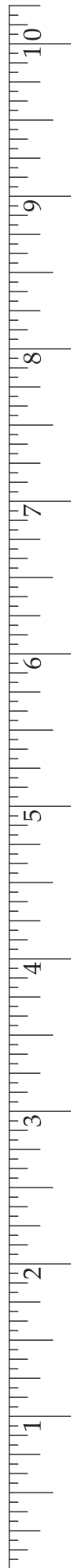



### Chamberlain-Fries Hook

Catalog#	Description	Length	Hook
PM-508	Single Sharp Hook	6-1/2" (165 mm)	9 mm



PM-508

### Humby Double Skin Hook

Catalog#	Description	Length	Hook
PM-0542	2 Sharp Hooks, Hinged for Adjustable Width	4-3/4" (121 mm)	3 mm

Great for retracting the nasal tip and also useful in eye and hand procedures. Distance between hooks can be adjusted.

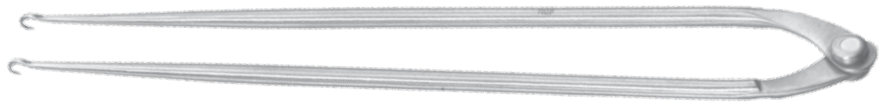

PM-0542

### Barsky Skin Hook

Catalog#	Description	Length	Width
PM-0504	Sharp Detachable Double Hook with Knurled Handle	6" (152 mm)	9.5 mm
PM-0505	Sharp Spare Double Hook for PM-0504		9.5 mm



PM-0504

### McCoy Micro-Dermal Hook

Catalog#	Description	Length	Hook
PM-325	Single Sharp Hook	5" (127 mm)	4 mm



PM-325



### Dingman Zygoma Hook

Catalog#	Description	Length	Hook
PM-408	Sharp, Heavy	7" (178 mm)	9 mm



PM-408

### Nova Jaw Hook

Catalog#	Description	Length	Hook
PM-5775	Sharp, Heavy	9" (229 mm)	19 mm



PM-5775

### Blocksma Palate Hook

Catalog#	Description	Length	Hook
PM-420	Single, Bent Down, Sharp	7" (178 mm)	3 mm
PM-421	Double, Bend Down, Sharp	7-1/4" (184 mm)	3 mm



PM-420



### Cottle Nasal Retractor

Catalog#	Description	Length	Width
21-144*	2 Sharp Prongs	5-1/2" (140 mm)	12 mm
PM-5411	Ball Left	5-3/4" (146 mm)	10 mm
PM-5412	Ball Right	5-3/4" (146 mm)	8 mm

\*Miltex® Brand



PM-5411

### Cottle Retractor/Hook

Catalog#	Description	Length	Width
PM-5405	2 Sharp Prongs	5-3/4" (146 mm)	12 mm
PM-5410	Ball Ends, 2 Prongs	6-1/2" (165 mm)	12 mm



PM-5405

### Adamson Double-Ended Hook and Retractor

Catalog#	Length	Retractor	Hook
PM-9056	6-1/4" (159 mm)	7.5 mm x 5 mm	3 mm



PM-9056

### Lahey Retractor

Catalog#	Description	Length	Hook
PM-4741	Single Prong, Sharp	4-3/4" (121 mm)	3 mm
PM-4742	2 Prong, Sharp	4-3/4" (121 mm)	4 mm
PM-4743	3 Prong, Sharp	4-3/4" (121 mm)	4 mm



PM-4741

### Kleinert-Ragnell Retractor

Catalog#	Description	Length	Retractor 1	Retractor 2
PM-4952	Double-Ended, Delicate	5-1/2" (140 mm)	10 mm x 5 mm	16 mm x 5 mm



PM-4952

### Ragnell Retractor

Catalog#	Description	Length	Retractor 1	Retractor 2
11-73*	Delicate, Double-Ended	6" (152 mm)	8 mm x 3 mm	15 mm x 5 mm



\*Miltex® Brand

11-73

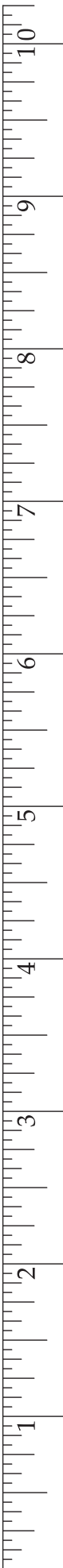

**Fomon Ball End Retractor**

Catalog#	Description	Length	Width
PM-5430	1 Prong, Blunt Ball End	6-1/4" (159 mm)	6.6 mm
PM-5435	2 Prong, Blunt Ball End	6-1/4" (159 mm)	11 mm



PM-5435

**Fomon Double Ball End Retractor**

Catalog#	Description	Length	Width
PM-5381	2 Prong, Blunt Ball Ends with Round Knurled Handle	6-1/4" (159 mm)	13 mm



PM-5381

**Rake Retractor**

Catalog#	Description	Length	Width
11-50*	One Sharp Prong	6-1/2" (165 mm)	10 mm
11-56*	One Blunt Prong	6-1/2" (165 mm)	10 mm
11-52*	Two Sharp Prongs	6-1/2" (165 mm)	5 mm
11-58*	Two Blunt Prongs	6-1/2" (165 mm)	5 mm
11-54*	Three Sharp Prongs	6-1/2" (165 mm)	8 mm
11-60*	Three Blunt Prongs	6-1/2" (165 mm)	8 mm
PM-4581	Four Sharp Prongs	6-1/2" (165 mm)	12 mm
PM-4582	Four Blunt Prongs	6-1/2" (165 mm)	12 mm

\*Miltex® Brand



11-58

**Flexible Shaft Retractor**

Catalog#	Description	Length	Width
11-30*	1 Sharp Prong	6" (152 mm)	5.5 mm
11-32*	2 Sharp Prongs	6" (152 mm)	5 mm
11-34*	3 Sharp Prongs	6" (152 mm)	8 mm
11-36*	1 Blunt Prong	6" (152 mm)	5.5 mm
11-38*	2 Blunt Prongs	6" (152 mm)	5 mm
11-40*	3 Blunt Prongs	6" (152 mm)	8 mm

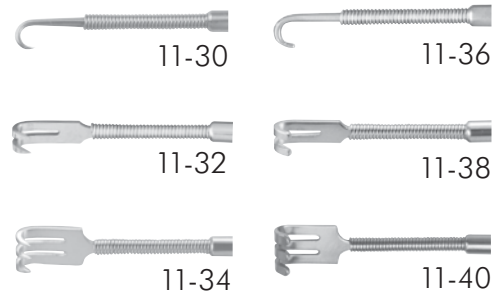

\*Miltex® Brand



11-32

### Aufricht Retractor

Catalog#	Description	Length	Tip Width
PM-5550	Fenestrated	6-7/8" (174 mm)	8 mm
PM-5551	Solid	6-7/8" (174 mm)	8 mm

See page 314 for Fiber Optic Version



PM-5550

### Senn Retractor

Catalog#	Description	Length	Retractor 1	Retractor 2
11-74*	Sharp, Double-Ended	6-3/8" (162 mm)	19 mm x 6.5 mm	7 mm
11-76*	Blunt, Double-Ended	6-3/8" (162 mm)	19 mm x 6.5 mm	9.5 mm
PM-3152	Single Ended, Delicate (no prongs)	6" (152 mm)	-	5 mm



11-76

PM-3152

\*Miltex® Brand

### Shaw Double-Ended Retractor

Catalog#	Description	Length	Retractor 1	Retractor 2
PM-680	Double-Ended	6-1/2" (165 mm)	22 mm x 6.5 mm	12 mm x 5 mm

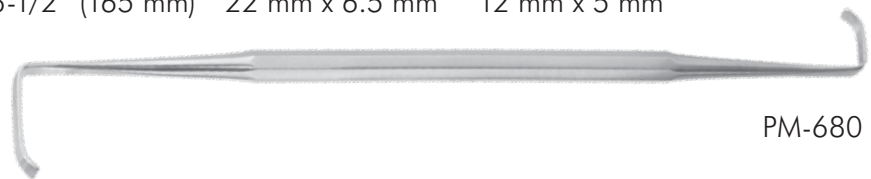

PM-680

### Love Nerve Retractor

Catalog#	Description	Length	Width
21-180*	Straight	8-1/2" (216 mm)	7 mm
26-1352*	Angled 45°	8-1/2" (216 mm)	7 mm
26-1354*	Angled 90°	8-1/2" (216 mm)	7 mm

\*Miltex® Brand



21-180

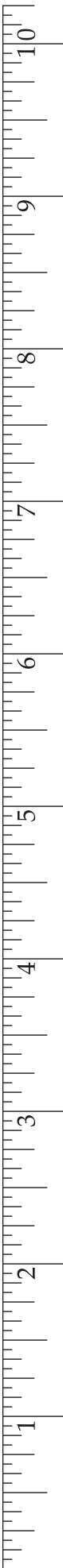

### Mathieu Retractor

Catalog#	Description	Length	Width
11-80*	Sharp, Double-Ended	6-1/2" (165 mm)	8 mm
11-81*	Blunt, Double-Ended	6-1/2" (165 mm)	8 mm

\*Miltex® Brand



11-80

### Curtin Skin and Subcutaneous Tissue Retractor

Catalog#	Description	Length	Width
PM-4826	6 Sharp Prongs	5-1/2" (140 mm)	15 mm



PM-4826

### Desmarres Lid Retractor

Catalog#	Description	Length	Width
PM-4315	Size 0	5-1/2" (140 mm)	10 mm
18-110*	Size 1	5-1/2" (140 mm)	12 mm
18-112*	Size 2	5-1/2" (140 mm)	14 mm
18-114*	Size 3	5-1/2" (140 mm)	16 mm
18-116*	Size 4	5-1/2" (140 mm)	18 mm
PM-4315IN	Size 0, Insulated	5-1/2" (140 mm)	10 mm
PM-4316IN	Size 1, Insulated	5-1/2" (140 mm)	12 mm
PM-4317IN	Size 2, Insulated	5-1/2" (140 mm)	14 mm

\*Miltex® Brand



PM-4315



PM-4315IN

### Kawamoto Double-Ended Retractor

Ideal for Transconjunctival Blepharoplasty

Catalog#	Description	Length	Width
PM-4320	Insulated Ends	6" (152 mm)	14 mm x 16 mm
PM-4326	Insulated Ends	6" (152 mm)	8 mm x 10 mm
PM-4347	Insulated Ends	6" (152 mm)	5 mm x 10 mm



PM-4320

### Zarem-Baylis Eyelid Retractor

Catalog#	Description	Length	Width
PM-4329	Clear, Autoclavable Plastic	5-1/4" (133 mm)	13 mm



PM-4329

### Jaeger Lid Plate

Catalog#	Description	Length	Width 1	Width 2
18-120*	Double-Ended	4-1/4" (108 mm)	20 mm	23 mm
PM-5020	Double-Ended	4-1/4" (108 mm)	21 mm	24 mm

\*Miltex® Brand



PM-5020

### Clodius Orbital Retractor

Commonly referred to as a Z-Type Retractor.

Catalog#	Description	Length	Width 1	Width 2
PM-652	Double-Ended	6-1/4" (159 mm)	13 mm	20 mm



PM-652

### Wise Orbit Retractor

Catalog#	Description	Length
PM-400	Double-Ended	6-3/4" (171 mm)



PM-400

### Smith Corneal Protection Shield

Used to cover the corneal globe during blepharoplasty and electrosurgery procedures.

Catalog#	Description	Diameter
PM-4311	Autoclavable, Green, Latex-Free	21 mm
PM-4312	Non-Autoclavable, White	21 mm



PM-4311

### Laser Eye Shield

Non-glare and autoclavable.

Catalog#	Description	Diameter
PM-5010	Laser Eye Shield Only	1" (25 mm)
PM-5012	Laser Eye Shield Kit: 2 Shields - PM5010, 1 Suction Handle - PM5015	1" (25 mm)
PM-5015	Spare Suction Handle Only	



PM-5010



PM-5015



### Cushing Retractor

Catalog#	Length	Width
----------	--------	-------

11-102\*      9" (229 mm)      11 mm x 13 mm

\*Miltex® Brand



11-102

### Miller Rake Retractor

Catalog#	Description	Length	Width
----------	-------------	--------	-------

PM-4829      9 Prongs, Blunt      5-1/4" (133 mm)      15 mm



PM-4829

### Davis Double-Ended Retractor

Catalog#	Length	Retractor 1	Retractor 2
----------	--------	-------------	-------------

PM-7810      5-3/4" (146 mm)      17 mm x 6 mm      20 mm x 9 mm



PM-7810

### Blair (Knapp-Rollet) Retractor

Catalog#	Description	Length	Width
----------	-------------	--------	-------

18-100\*      4 Sharp Prongs      5-1/4" (133 mm)      5 mm

\*Miltex® Brand



18-100



### Knapp Retractor

Catalog#	Description	Length	Width
18-102*	4 Blunt Prongs	5-1/4" (133 mm)	5 mm

\*Miltex® Brand



18-102

### Converse Retractor

Catalog#	Description	Length	Width 1	Width 2
21-163*	Double-Ended, Blunt Prongs	4" (102 mm)	10 mm	14 mm

\*Miltex® Brand



21-163

### Caroline Finger Retractor

Catalog#	Length	Width
PM-801	4-1/4" (108 mm)	6.5 mm



PM-801

### Chamberlain-Fries Retractor

Catalog#	Description	Length	Width
PM-825	Aluminum Handle	7-1/2" (191 mm)	1/2" (13 mm)



PM-825

### Padgett Swivel Double Hook/Retractor

Catalog#	Description	Length	Width
PM-886	2 Sharp Prongs with Swivel Ring	3-1/2" (89 mm)	10 mm



### Martinez-Kilner Nasal Retractor

PM-886

Catalog#	Description	Length	Width
PM-880	2 Sharp Prongs with Thumb Ring	4-1/2" (114 mm)	7.5 mm



### Sheen Nasal Retractor

PM-880

Catalog#	Description	Length	Width
PM-881	Angled	6-1/2" (165 mm)	10 mm



### Sheen Retractor

Great for nasal tip retraction.

Catalog#	Description	Length	Width
PM-865	Curved	6-1/4" (159 mm)	6.5 mm



PM-865

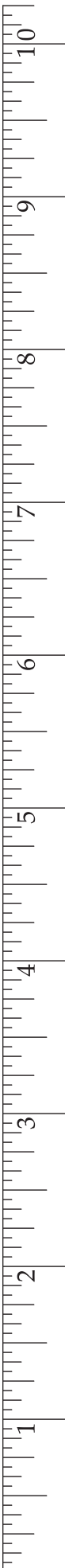

### Skin Retractor

Catalog#	Description	Length	Width 1	Width 2
PM-0598	Double-Ended, Sharp	6-1/2" (165 mm)	10 mm	6 mm



PM-0598

### Kilner Alae Retractor

Catalog#	Description	Length	Width
PM-0552-3/8	2 Sharp Prongs	3-1/8" (79 mm)	3/8" (9.5 mm)
PM-0552-1/2	2 Sharp Prongs	3-1/8" (79 mm)	1/2" (13 mm)



PM-0552-3/8

### Kilner Nasal Retractor

Catalog#	Length	Retractor
PM-0562	5-1/4" (133 mm)	60 mm x 7 mm



PM-0562

### Maliniac Nasal Retractor

Catalog#	Length	Retractor
PM-5705	4" (102 mm)	45 mm x 9 mm



PM-5705

### Freeman Flap Retractor

Ideal for holding face or breast tissue flap securely in the bend of the retractor.

Catalog#	Length	Width
PM-490	8" (203 mm)	1/2" (13 mm)
PM-491	8" (203 mm)	1" (25 mm)

See page 315 for Fiber Optic Version

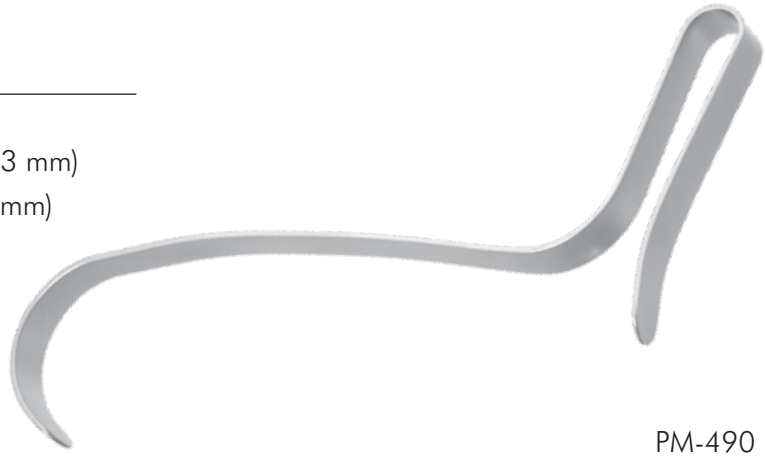

PM-490

### Farabeuf Retractor

Catalog#	Description	Length	Retractor 1	Retractor 2
11-110*	Standard, Set of Two	6" (152 mm)	25 mm x 16 mm	31 mm x 16 mm
11-112*	Delicate, Set of Two	4-3/4" (121 mm)	25 mm x 10 mm	32 mm x 13 mm

\*Miltex® Brand



11-112

### U.S. Army Retractor

Catalog#	Description	Length	Retractor 1	Retractor 2
11-122*	Set of Two	8-1/2" (216 mm)	38 mm x 22 mm	41 mm x 25 mm

\*Miltex® Brand



11-122

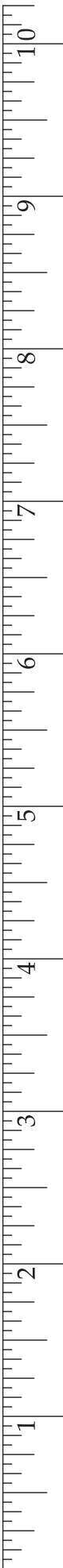

### Deaver Retractor

Catalog#	Description	Length	Retractor
PM-4570	Delicate	8" (203 mm)	5/8" (16 mm)
PM-4571	Delicate	8" (203 mm)	1" (25 mm)

See page 315 for Fiber Optic Versions



PM-4571

### Padgett-Deaver Retractor

Catalog#	Length	Width
PM-9057	12" (305 mm)	1" (25 mm)

See page 316 for Fiber Optic Versions



PM-9057

### Ribbon Retractor

Catalog#	Description	Length	Width
PM-4205	Infant, Delicate, Malleable	6-3/4" (171 mm)	5/8" (16 mm)
11-144*	Pediatric, Delicate, Malleable	8" (203 mm)	5/8" (16 mm)
11-146*	Pediatric, Delicate, Malleable	8" (203 mm)	1" (25 mm)



\*Miltex® Brand

11-144

### Ribbon Retractor

Catalog#	Description	Length	Width
11-130*	Malleable	13" (330 mm)	3/4" (19 mm)
11-132*	Malleable	13" (330 mm)	1" (25 mm)
11-134*	Malleable	13" (330 mm)	1-1/4" (32 mm)
11-136*	Malleable	13" (330 mm)	1-1/2" (38 mm)
11-140*	Malleable	13" (330 mm)	2" (51 mm)

\*Miltex® Brand



11-132

### Meyerding Finger Retractor

Catalog#	Description	Length	Retractor
11-88*	Style 1	7" (178 mm)	18 mm x 7.5 mm
11-90*	Style 2 with 3 Sharp Teeth	7" (178 mm)	16 mm x 5.5 mm
11-92*	Style 3 with 3 Sharp Teeth	7" (178 mm)	8 mm x 4.5 mm
11-94*	Style 4	7" (178 mm)	10 mm x 3.5 mm
11-96*	Style 5	7" (178 mm)	8 mm x 4 mm

\*Miltex® Brand



11-88

### Padgett "S" Retractor

Catalog#	Description	Length	Retractor 1	Retractor 2
PM-4807	Double-Ended	4-1/2" (114 mm)	15 mm x 11 mm	14 mm x 10 mm



PM-4807

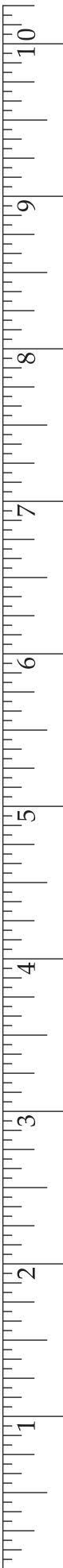

### Yancoskie Coronal Lift Retractor

Catalog#	Description	Length	Width
PM-565	6 Sharp Prongs, Offset	8-1/2" (216 mm)	150 mm



PM-565

### Coronal Brow Lift Retractor

Catalog#	Description	Length	Width
21-129*	7 Sharp Prongs, Offset	7-1/4" (184 mm)	70 mm

\*Miltex® Brand



21-129



### Yancoskie Abdominoplasty Retractor

Catalog#	Description	Length	Width
PM-566	6 Sharp Prongs, Offset (gold handle)	7-1/2" (191 mm)	150 mm
21-130*	6 Sharp Prongs, In-Line	7-1/2" (191 mm)	152 mm

\*Miltex® Brand



PM-566

### Freeman Face Lift Retractor

Catalog#	Description	Length	Width
PM-518	Small Finger Ring, 4 Sharp In-Line Prongs	4" (102 mm)	21.8 mm
21-124*	Large Finger Ring, 4 Sharp In-Line Prongs	4-3/4" (121 mm)	25 mm

\*Miltex® Brand



PM-518

### Freeman Face Lift Retractor

Catalog#	Description	Length	Width
PM-520	Adamson Model, 4 Sharp Offset Prongs	7" (178 mm)	37 mm



PM-520

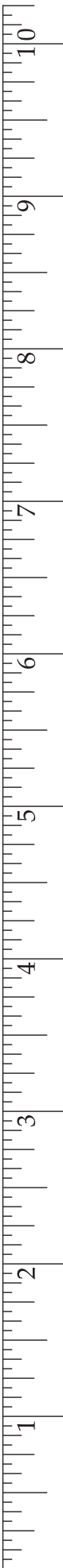

### Freeman Flap Rake Retractor

Catalog#	Description	Length	Width
21-123*	4 Sharp In-Line Prongs	4-1/4" (108 mm)	1-1/4" (32 mm)

\*Miltex® Brand



21-123

### Freeman Face Lift Retractor

Catalog#	Description	Length	Width
PM-509	4 Sharp Offset Prongs	7" (178 mm)	1-1/2" (38 mm)
PM-509IL	4 Sharp In-Line Prongs	7" (178 mm)	1-1/2" (38 mm)
PM-519	4 Sharp Petite, Offset Prongs	7" (178 mm)	7/8" (22 mm)
PM-519IL	4 Sharp Petite, In-Line Prongs	7" (178 mm)	7/8" (22 mm)
21-126*	4 Sharp Offset Prongs	7-1/4" (184 mm)	1-1/2" (38 mm)
21-125*	4 Sharp In-Line Prongs	7-1/4" (184 mm)	1-1/2" (38 mm)
21-128*	4 Sharp Offset Prongs	7-1/4" (184 mm)	7/8" (22 mm)
21-127*	4 Sharp In-Line Prongs	7-1/4" (184 mm)	7/8" (22 mm)

\*Miltex® Brand



PM-509IL



PM-509



21-127



21-128

### Farr Style Spring Retractor

Catalog#	Description	Width
PM-4105	Sharp Points	1-1/2" (38 mm)
PM-4110	Sharp Points	2" (51 mm)
PM-4115	Sharp Points	2-1/4" (57 mm)
PM-4120	Sharp Points	2-1/2" (64 mm)
PM-4125	Sharp Points	3" (76 mm)
PM-4130	Thin Flat Blunt Points	2-1/2" (64 mm)



PM-4105

### Alm Self-Retraining Retractor

Catalog#	Description	Length	Width
PM-5750	4x4 Blunt Prongs	2-3/4" (70 mm)	2" (51 mm)
PM-447	4x4 Sharp Prongs	2-3/4" (70 mm)	2" (51 mm)
PM-5751	4x4 Blunt Prongs	4" (102 mm)	2-1/2" (64 mm)

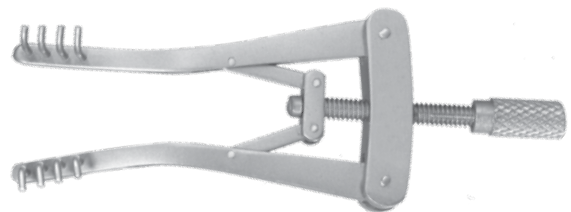

PM-5750

### Holzheimer Cross-Action Retractor

Catalog#	Description	Length	Width
11-14*	4x4 Sharp Prongs	4" (102 mm)	1" (25 mm)
11-16*	4x4 Blunt Prongs	4" (102 mm)	1" (25 mm)



11-14

\*Miltex® Brand



### Barsky Nasal Retractor

Catalog#	Length	Width
PM-0502	3-3/4" (95 mm)	10 mm x 55 mm



PM-0502

### Terry Nasal Retractor

Catalog#	Length	Width
PM-728	6" (152 mm)	5 mm x 46 mm



PM-728

### Salinger Reduction Instrument

Catalog#	Length	Width
PM-4847	5 1/2" (140 mm)	9.5 mm

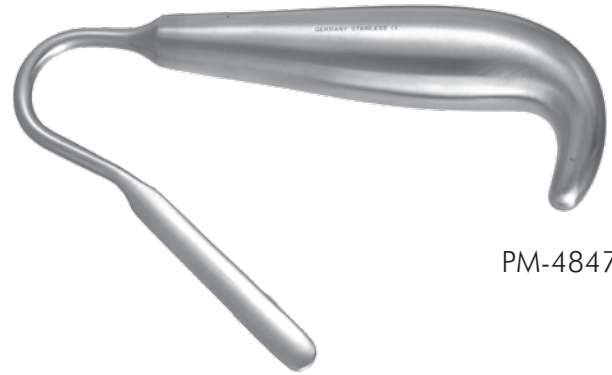

PM-4847

### Paparella-Weitlaner Retractor

Catalog #	Description	Length	Jaw Dimensions
11-625*	2x2 semi-sharp prongs	5" (127 mm)	33 mm inside spread, 13 mm long prongs



11-625

\*Miltex® Brand

### Gruber Rhinoplasty Retractor

Catalog#      Description

PM-877      Latex-Free, Autoclavable



PM-877

### Gruber Rhinoplasty Procedure Set

Catalog#      Description

PM-9500      See page 392-393 for more details

### Gruber Columella Retractor

Catalog#      Description

PM-876      With Weight



PM-876

### Tsur Open Rhinoplasty Retractor

Catalog#      Length      Width

PM-866      3-1/2" (89 mm)      20 mm

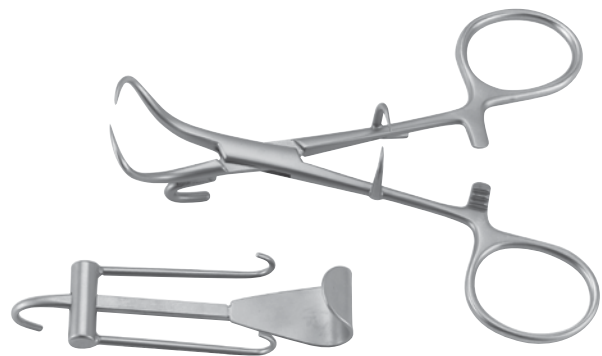

PM-866

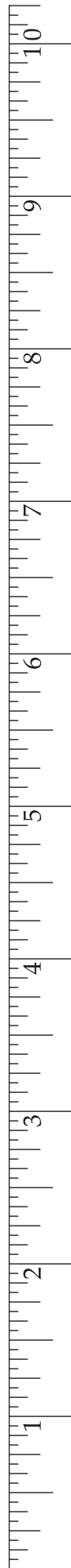

### Kasdan Hand Retractor

Catalog#	Description	Length	Retractor 1	Retractor 2
PM-760	Double-Ended	6-1/4" (159 mm)	1/2" x 1/4" (13 mm x 6.5 mm)	3/4" x 3/8" (19 mm x 9.5 mm)



PM-760

### Faust "Push" Retractor

Catalog#	Description	Length	Retractor	Hook Width
PM-5615	Double-Ended	5-1/2" (140 mm)	3/4" x 1/4" (19 mm x 6.5 mm)	1/4" (6.5 mm)



PM-5615

### Converse Hand Retractor

Catalog#	Description	Length	Retractor
PM-5625	Set of Four	3-1/2" (89 mm)	
	Size 1		9 mm x 19 mm
	Size 2		13 mm x 30 mm
	Size 3		13 mm x 43 mm
	Size 4		13 mm x 55 mm

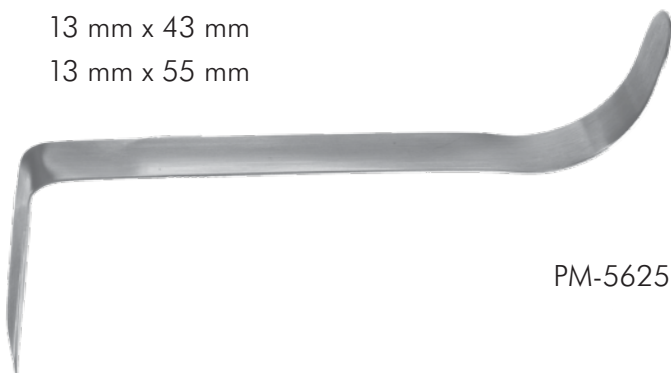

PM-5625

### Biggs Mammoplasty Retractor

Catalog#	Description	Length	Width
----------	-------------	--------	-------

PM-529	Standard Size	8" (203 mm)	50 mm
--------	---------------	-------------	-------

See page 313 for Fiber Optic Version

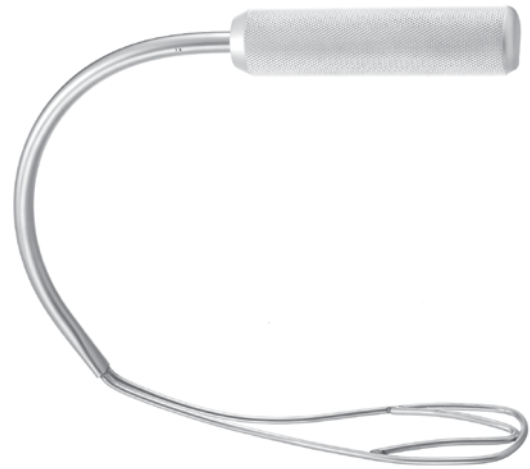

PM-529

### Biggs Mammoplasty Retractor

Catalog#	Description	Length	Width
----------	-------------	--------	-------

PM-530	Narrow	8" (203 mm)	30 mm
--------	--------	-------------	-------

See page 313 for Fiber Optic Version



PM-530

### Ferreira Breast Augmentation Retractor

Catalog#	Handle Length	Blade
----------	---------------	-------

PM-895	5-1/8" (130 mm)	1" (25 mm) x 6-3/4" (171 mm)
--------	-----------------	------------------------------

\* See page 313 for Fiber Optic version

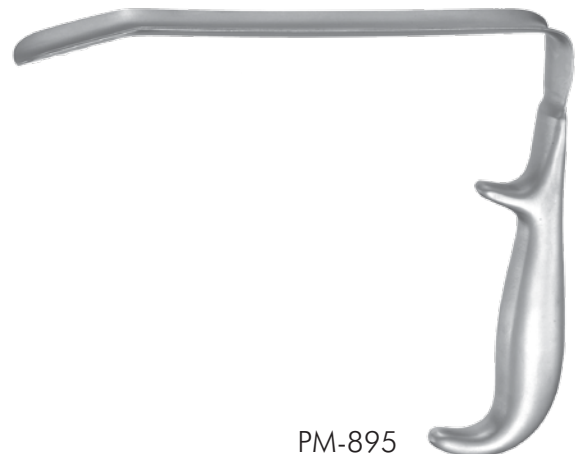

PM-895





### Ferreira Face Lift Retractor

Catalog#	Blade Length	Width
----------	--------------	-------

PM-890	4-1/4" (108 mm)	22 mm
--------	-----------------	-------

See page 314 for Fiber Optic Version



PM-890

### Biggs Face Lift Retractor

Catalog#	Length	Width
----------	--------	-------

PM-884	8" (203 mm)	51 mm
--------	-------------	-------

See page 312 for Fiber Optic Version

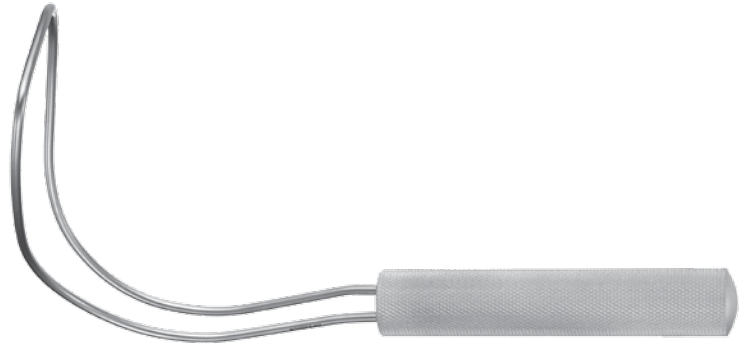

PM-884

### Juri Face Lift Retractor

Catalog#	Width
----------	-------

PM-699	35 mm
--------	-------

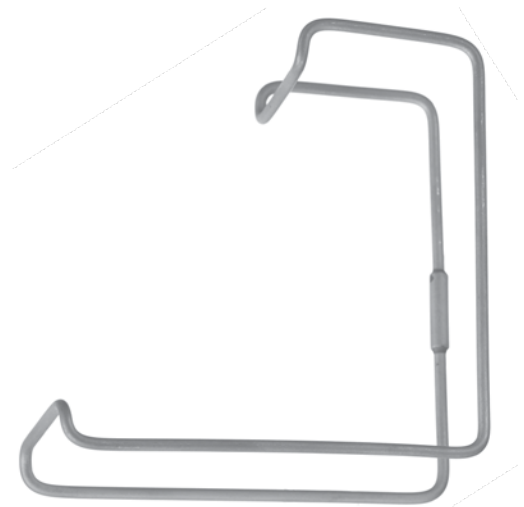

PM-699



## Dingman Mouth Gag

Excellent for cleft palate procedures

### Catalog# Description

2-115\* Complete set with three tongue blades, adjustable upper blades & cheek retractors, grooved endotracheal type tongue blades, coil spring on upper frame for suture handling

\*Miltex® Brand



2-115

## Tongue Blade

Catalog#	Description	Length	Blade Dimension
2-116*	For Dingman Mouth Gag, Size Small	6" (152 mm)	24 mm x 52 mm
2-117*	For Dingman Mouth Gag, Size Medium	6" (152 mm)	28 mm x 55 mm
2-118*	For Dingman Mouth Gag, Size Large	6" (152 mm)	30 mm x 68 mm

\*Miltex® Brand



2-116 thru 2-118



### Millard-Dingman Mouth Gag

Catalog#	Description
----------	-------------

PM-110	Comes complete with three tongue blades
--------	---



PM-110

### Kilner-Doughty Mouth Gag

Catalog#	Description
----------	-------------

PM-1754	With Three Tongue Blades
---------	--------------------------



PM-1754

### Mclvor Mouth Gag

Catalog#	Description	Size	Blade
----------	-------------	------	-------

2-182*	Mouth Gag Frame Only		
2-130*	Blade	1	3/4" x 1" (19 mm x 25 mm)
2-132*	Blade	2	1" x 2-3/4" (25 mm x 70 mm)
2-134*	Blade	3	1" x 3-1/4" (25 mm x 83 mm)
2-136*	Blade	4	1" x 3-3/4" (25 mm x 95 mm)
2-138*	Blade	5	1" x 4" (25 mm x 102 mm)
2-180*	Full set with mouth gag and 3 blades (one each of 2-132, 2-134, 2-136)		

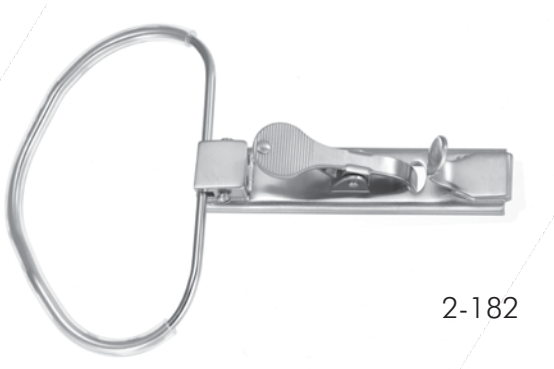

2-182

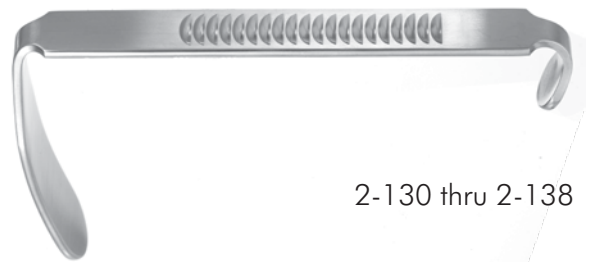

2-130 thru 2-138

\*Miltex® Brand

### Denhardt Mouth Gag

Catalog#	Description	Length
----------	-------------	--------

2-154\* with Grip Lock 5" (127 mm)

\*Miltex® Brand

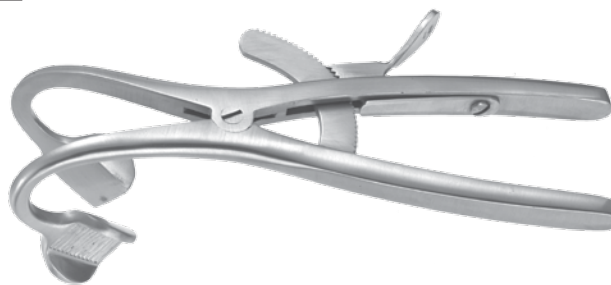

2-154

### Jennings Mouth Gag

Catalog#	Description	Spread
----------	-------------	--------

2-164\* Small (Infant) 3-3/4" (95 mm) wide  
 2-162\* Medium (Child) 4-3/4" (121 mm) wide  
 2-160\* Large (Adult) 6" (152 mm) wide

\*Miltex® Brand



2-162

### Wieder Tongue Depressor

Catalog#	Description	Length	Blade
----------	-------------	--------	-------

22-4\* Large 5" (127 mm) 36 mm wide  
 22-2\* Small 5" (127 mm) 28 mm wide

\*Miltex® Brand



22-4

### Marshall Intraoral Wiring Retractor and Holder

Catalog#	Length
----------	--------

PM-4752 7-1/4" (184 mm)



PM-4752

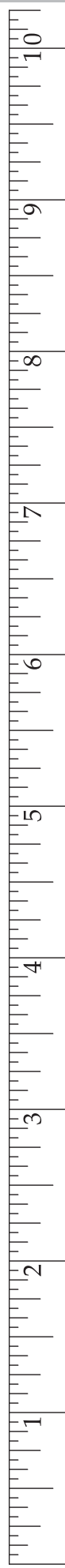

**Logan Bow (for cleft palate surgery)**

Catalog#	Description	Width
PM-7820	With Teeth	1" (25 mm)
PM-7821	With Teeth	1 1/4" (32 mm)
PM-7822	With Teeth	1 3/8" (35 mm)
PM-7830	Plain	1" (25 mm)
PM-7831	Plain	1 1/4" (32 mm)
PM-7832	Plain	1 3/8" (35 mm)



PM-7820

**Oringer Lip Retractor**

Catalog#	Description
PM-4823	Large



PM-4823

**Kilpatrick Lip and Cheek Retractor**

Catalog#	Description	Length	Blade
22-210*	Swivel Blade	7-3/4" (197 mm)	35 mm

\*Miltex® Brand



22-210

**Mouth Prop**

Catalog#	Description
PM-0058	Large with Chain
PM-0062	Medium with Chain
PM-0064	Small with Chain



PM-0058

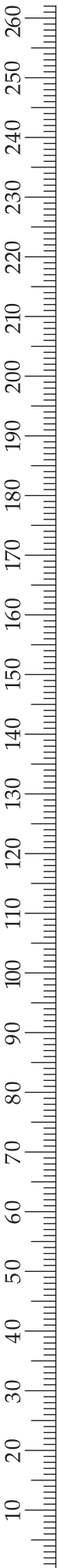

### Cheek and Lip Retractors

Catalog#	Description
PM-1730	Transparent, Package of 2 Autoclavable, Latex-Free
017-31610*	Spandex Lip Retractor - Adult
017-31611*	Spandex Lip Retractor - Child
017-31620*	Lip Retractor - Adult
017-31621*	Lip Retractor - Child
017-31622*	Lip Retractor - Double End

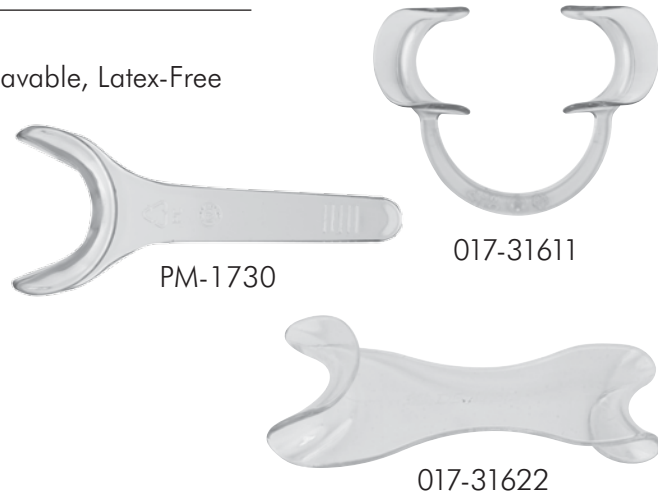

\*Miltex® Brand

### Fischl "Shoe Horn" Retractor

Catalog#	Description	Length	Width
PM-675	Double-Ended	5-5/8" (143 mm)	16 mm



### Crile Retractor

Catalog#	Description	Length	Retractor 1	Retractor 2
11-78*	Double-Ended	4-1/4" (108 mm)	11 mm x 3 mm	20 mm x 6 mm

\*Miltex® Brand





### Cronin Lip and Nostril Retractor

Catalog#	Length	Width
PM-606	6" (152 mm)	14 mm



PM-606

### Cronin Cheek Retractor

Catalog#	Length	Width
PM-607	6" (152 mm)	19 mm



PM-607

### Cronin Retractor

Catalog#	Description	Length	Retractor 1	Retractor 2
PM-614	Double-Ended	4-1/4" (108 mm)	15 mm x 23 mm	15 mm x 38 mm



PM-614

### Cottle Septum Speculum

Catalog#	Description	Length	Depth
PM-4264	Thin Blades, with Set Screw	5-1/2" (140 mm)	30 mm

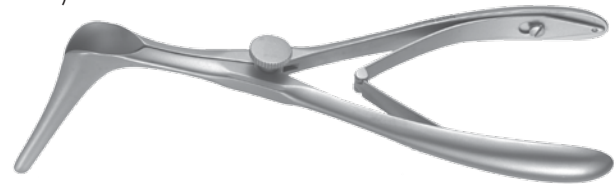

### Cottle Septum Speculum, Ebony Finish

PM-4264

Catalog#	Description	Length	Depth
20-36-35*	Black Chrome with Set Screw, Narrow	6" (152 mm)	35 mm
20-36-50*	Black Chrome with Set Screw, Narrow	6" (152 mm)	50 mm
20-36-75*	Black Chrome with Set Screw, Narrow	6" (152 mm)	75 mm
20-36-90*	Black Chrome with Set Screw, Narrow	6" (152 mm)	90 mm
20-37-45*	Black Chrome with Set Screw, Extra Delicate	6" (152 mm)	45 mm
20-37-75*	Black Chrome with Set Screw, Extra Delicate	6" (152 mm)	75 mm

\*Miltex® Brand

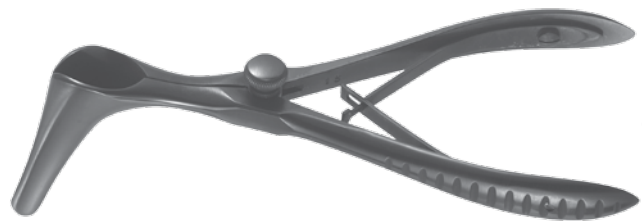

20-36-35

### Tieck-Halle Nasal Speculum

Catalog#	Description	Length	Depth
20-12*	For Infants	5-1/2" (140 mm)	18 mm

\*Miltex® Brand



20-12

### Thudichums Nasal Speculum

Catalog#	Description	Length
PM-1170-0	Size 0	2-1/2" (64 mm)
PM-1170-1	Size 1	2-1/2" (64 mm)
PM-1170-2	Size 2	2-1/2" (64 mm)
PM-1170-3	Size 3	2-1/2" (64 mm)
PM-1170-4	Size 4	2-1/2" (64 mm)

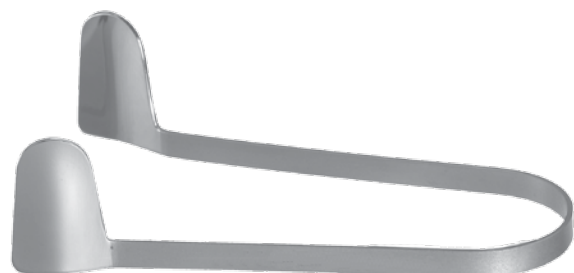

PM-1170-2



### Killian Septum Speculum

Catalog#	Description	Length	Depth
20-28*	with Set Screw	6" (152 mm)	2" (51 mm)
20-29*	with Set Screw	6" (152 mm)	2-1/2" (64 mm)
20-30*	with Set Screw	6" (152 mm)	3" (76 mm)
20-32*	with Set Screw	6" (152 mm)	3-1/2" (89 mm)
PM-4670	Black Chrome without Set Screw	6" (152 mm)	2" (51 mm)
PM-4671	Black Chrome without Set Screw	6" (152 mm)	3" (76 mm)

See page 316 for Fiber Optic Version

\*Miltex® Brand



20-28

### Cottle Septum Speculum

Catalog#	Length	Depth
PM-4275	5-1/2" (140 mm)	2" (51 mm)



PM-4275

### Vienna Nasal Speculum

Catalog#	Description	Length	Depth
20-4*	Small	5-3/4" (146 mm)	28 mm
20-3*	Medium	5-3/4" (146 mm)	30 mm
20-2*	Large	5-3/4" (146 mm)	32 mm
20-6*	Light weight, Adult	5-3/4" (146 mm)	30 mm
20-7*	Light weight, Child	5-3/4" (146 mm)	33 mm

\*Miltex® Brand



20-4



# KNIVES AND HANDLES



Knife Handles

Blades

Blade Breakers

Knives - Miscellaneous

Skin Graft Knives

**Gruber Combination Knife Handle & Perichondrium Elevator**

Catalog#	Description	Length	Blade Size
PM-444	#7	6-1/2" (165 mm)	10-15c



**Bard-Parker Knife Handle**

PM-444

Catalog#	Description	Length	Blade Size
4-7*	#3, with mm & cm markings	5" (127 mm)	10-15c
4-8*	#4, with mm & cm markings	5-3/8" (137 mm)	20-25
4-10*	#3 Long	8-1/2" (216 mm)	10-15c
4-11*	#4 Long	8-1/2" (216 mm)	20-25
4-16*	#9	4-1/2" (114 mm)	10-15c

\*Miltex® Brand



**Barrons Knife Handle**

4-7

Catalog#	Description	Length	Blade Size
PM-425	#3 Octagonal	5-1/2" (140 mm)	10-15c



**Scalpel Handle**

PM-425

Catalog#	Description	Length	Blade Size
PM-448	#3 Round, Angled	5-3/4" (146 mm)	10-15c



PM-448

**Berrino Twisted Knife Handle**

Catalog#	Description	Length	Blade Size
PM-443	#3	5" (127 mm)	10-15c



PM-443



### Siegel Scalpel Handle

Catalog#	Description	Length	Blade Size
----------	-------------	--------	------------

4-17*	#3 Straight, Round	6-1/8" (156 mm)	10-15c
-------	--------------------	-----------------	--------

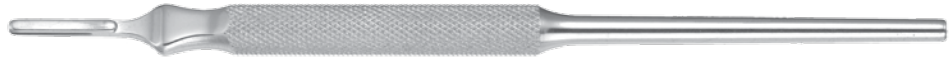

\*Miltex® Brand

4-17

### Field Knife Handle

Cross pins prevent handle from rolling.

Catalog#	Description	Length	Blade Size
----------	-------------	--------	------------

PM-649	#3 Round	6" (152 mm)	10-15c
--------	----------	-------------	--------

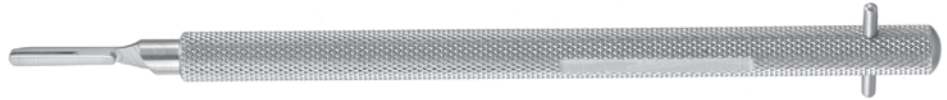

PM-649

### Novark Knife Handle

Catalog#	Description	Length	Blade Size
----------	-------------	--------	------------

PM-650	#3 Round, Aluminum, Gold Plate	6" (152 mm)	10-15c
--------	--------------------------------	-------------	--------



PM-650

### Scalpel Handle

Catalog#	Description	Length	Blade Size
----------	-------------	--------	------------

4-9*	#7 Stainless Steel	6-1/2" (165 mm)	10-15c
------	--------------------	-----------------	--------

4-18*	#5 Green Plastic Handle	5" (127 mm)	10-15c
-------	-------------------------	-------------	--------



4-9

\*Miltex® Brand



4-18

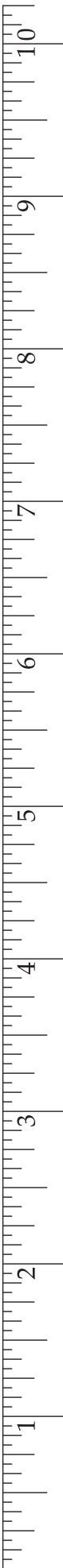

## Surgical Blades, Sterile

### Carbon, Stainless Steel or Silicone Coated

- Razor-sharp cutting edge for superior cutting and clean incisions
- Sterile, 5-year shelf life
- Individually packaged in foil peel packs
- Convenience of disposables, single-use
- Sizes clearly marked on each blade
- Available in carbon, stainless steel and silicone coated
- Each dispenser box contains 100 blades

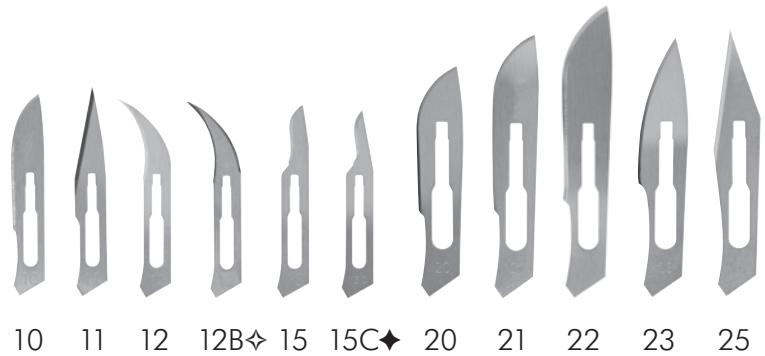

CS* Catalog#	SS** Catalog#	SC*** Catalog#	Size
4-110	4-310	4610	10
4-111	4-311	4611	11
4-112	4-312	-	12
4-112B	4-312B	-	12B
4-115	4-315	4615	15
4-115C	4-315C	-	15C
4-120	4-320	-	20
4-121	4-321	-	21
4-122	4-322	-	22
4-123	4-323	-	23
4-125	4-325	-	25

\*Carbon Steel \*\* Stainless Steel \*\*\*Silicone Coated  
 B is a double edged blade  
 C is an angled blade

For your convenience, Miltex, Inc. offers a wide array of scalpel blade handles and the Miltex® Blade-Safe Remover to aid in the safe removal of blades and to help protect against accidental cuts and punctures.

## Surgical Blade-Safe, Surgical Blade Remover

Catalog#	Description
4-100	Blade-Safe Surgical Blade Remover For Any Style Handle



4-100

### Barraquer Blade Breaker & Holder

Catalog#	Description	Length
18-170	With Ratchet Lock	4-1/2" (114 mm)

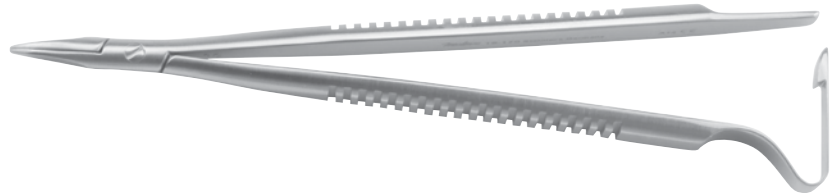

18-170

### Castroviejo Blade Breaker & Holder

Catalog#	Description	Length
18-171	With Push-Pull Lock	5-1/4" (133 mm)

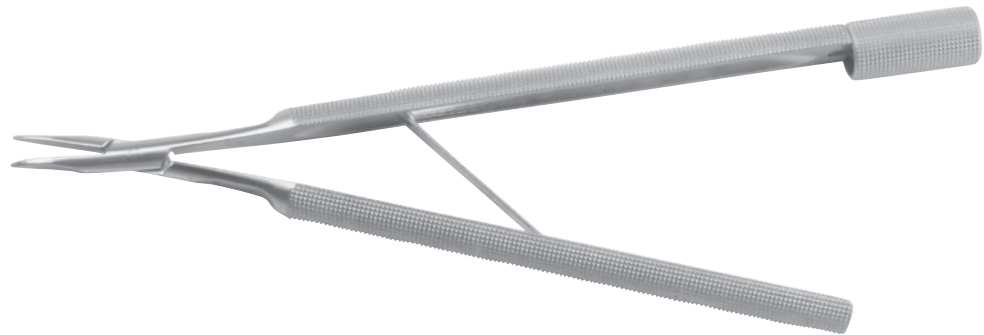

18-171

### Troutman-Barraquer Mini Blade Breaker & Holder

Catalog#	Description	Length
18-172	Angled Jaws 3 x 10 mm, With Push-Pull Lock	3-3/4" (95 mm)

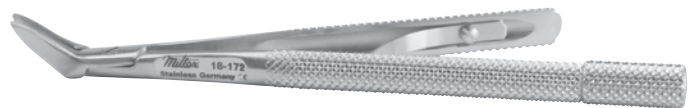

18-172

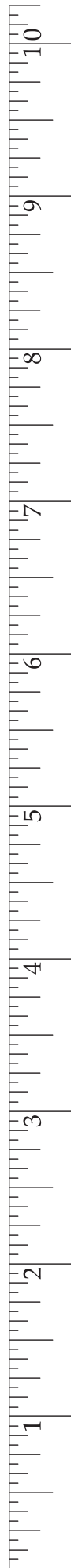



### Freer Septum Knife

Catalog#	Description	Length	Blade
----------	-------------	--------	-------

20-202*	Angled Blade	7-1/2" (191 mm)	5 mm x 7.5 mm
---------	--------------	-----------------	---------------

\*Miltex® Brand



20-202

### Freer Mucosa Septum Knife

Commonly called the "D" knife. Used for cutting nasal mucosa or making parallel cuts in nasal cartilage.

Catalog#	Length	Blade
----------	--------	-------

20-200*	6-1/4" (159 mm)	7.7 mm x 5 mm
---------	-----------------	---------------

\*Miltex® Brand



20-200

### Cronin Septum Knife

Catalog#	Description	Length	Blade
----------	-------------	--------	-------

PM-605	With cm Marks	6-1/2" (165 mm)	7.5 mm x 4 mm
--------	---------------	-----------------	---------------



PM-605

### Freer-Ingal Submucous Knife

Catalog#	Length	Blade
----------	--------	-------

PM-4293	6-1/2" (165 mm)	7.5 mm x 3 mm
---------	-----------------	---------------



PM-4293

### Ballenger Swivel Bayonet Knife

Catalog#	Length	Blade Width
20-222*	7-3/4" (197 mm)	3 mm
20-224*	7-3/4" (197 mm)	4 mm
PM-4302	8" (203 mm)	5 mm

Ballenger knives are ideal for trimming septal cartilage.

\*Miltex® Brand



20-222

### Ballenger Swivel Knife

Catalog#	Description	Length	Blade Width
20-216*	Straight	7-3/4" (197 mm)	3 mm
20-218*	Straight	7-3/4" (197 mm)	4 mm
20-220*	Straight	7-3/4" (197 mm)	5 mm

\*Miltex® Brand



20-216

### Joseph Double-Edge Nasal Knife

Catalog#	Description	Length	Blade
21-2*	Straight, Narrow/Small Blade, Sharp Tip	6" (152 mm)	23 mm x 4 mm
21-4*	Straight, Wide/Large Blade, Sharp Tip	6" (152 mm)	23 mm x 6 mm
PM-5102	Curved, Narrow/Small Blade, Sharp Tip	6" (152 mm)	23 mm x 4 mm
PM-5103	Curved, Wide/Large Blade, Sharp Tip	6" (152 mm)	23 mm x 6 mm
PM-5110	Straight, Narrow/Small Blade, Blunt Tip	6" (152 mm)	23 mm x 4 mm
PM-5111	Straight, Wide/Large Blade, Blunt Tip	6" (152 mm)	23 mm x 6 mm
21-16*	Curved, Narrow/Small Blade, Blunt Tip	6" (152 mm)	23 mm x 4 mm
21-18*	Curved, Wide/Large Blade, Blunt Tip	6" (152 mm)	23 mm x 6 mm

\*Miltex® Brand



21-2

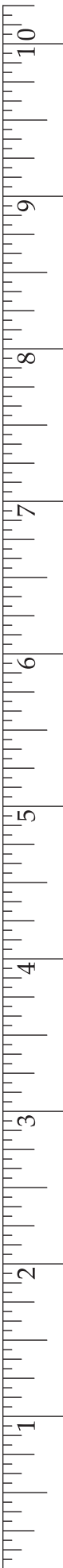

## Joseph Button End Knife

For planing nasal cartilage

Catalog#	Description	Length	Blade
PM-5130	Straight	6" (152 mm)	29 mm x 6 mm



PM-5130

## Joseph Button End Knife

Catalog#	Description	Length	Blade
PM-5131	Angled	6-1/2" (165 mm)	9 mm x 3 mm



PM-5131

## Cottle Knife

Catalog#	Description	Length	Blade
PM-5160	Straight, Single-Edge	6" (152 mm)	32 mm x 3 mm
PM-5165	Straight, Double-Edged	6" (152 mm)	32 mm x 3 mm
PM-5166	Curved, Double-Edged	6" (152 mm)	32 mm x 3 mm



PM-5160

## Habal Capsulotomy Knife

Separates spherical contracture and encapsulating scar around breast implant during open capsulotomy procedures.

Catalog#	Length	Width
PM-790	10-3/4" (273 mm)	8.5 mm



PM-790



### Foerster Capsulotomy Knife

Separates spherical contracture and encapsulating scar around breast implant during open capsulotomy procedures. Dual edge of knife runs along the implant while fibrous tissue is dissected.

Catalog#	Length	Blade Width
PM-9019	11" (279 mm)	8.5 mm



PM-9019

### Epstein Carpal Tunnel Knife Guide

Catalog#	Length
PM-195	7" (178 mm)



PM-195

### Cronin Cleft Palate Knife

Catalog#	Description	Length	Blade
PM-603	Triangular	7" (178 mm)	5 mm
PM-604	Rectangular	7" (178 mm)	5 mm



PM-603

### Alexander Otoplasty Knife

Catalog#	Description	Length	Blade Length
PM-800	Three Serrated Blades	6-1/4" (159 mm)	1/4" (6.5 mm)



PM-800



### House Knives with Octagonal Handle

Catalog#	Description	Length	Blade
19-2522*	Tympanoplasty Knife	6-1/2" (165 mm)	7 mm curved blade
19-2523*	Lancet No. 2 Knife	6-1/2" (165 mm)	2 mm x 3 mm tapered tip angled 45 degrees
19-2524*	Incudostapedial Joint Knife	6-1/2" (165 mm)	0.5 mm wide x 1.5 mm long, blade angled 20 degrees
19-2525*	Incudostapedial Joint Knife	6-1/2" (165 mm)	0.75 mm diameter blade angled 60 degrees
19-2526*	Sickle No.1 Knife	6" (152 mm)	0.75 mm curved blade
19-2527*	Myringotomy Knife	6" (152 mm)	3.5 mm blade

\*Miltex® Brand



19-2522    19-2523    19-2524    19-2525    19-2526    19-2527

19-2526    19-2527

### Silver Miniature Skin Graft Knife

Ideal for office use involving small "postage stamp" size grafts. It can also be used for wound debridement.

Catalog#	Description	Length
PM-14701	Uses Standard Double-Edge Razor Blade	7-1/2" (191 mm)



PM-14701

### Watson Skin Graft Knife

Modified Braithwaite design with a fine smooth rod which glides on the skin. It is a versatile and accurate hand held knife with an adjustable cut depth of 0.1mm to 1.0mm.

Catalog#	Description	Length
PM-4597	Standard, Uses PM-4596 Blades	12" (305 mm)
PM-4597LH	Left-Hand, Uses PM-4596 Blades	11-3/4" (298 mm)



PM-4597



PM-4597LH

### Cobbett Graft Knife

Modified Braithwaite design with a grooved rod on which the knife oscillates.

Catalog#	Description	Length
PM-4598	Uses PM-4596 Blades	12-1/2" (318 mm)

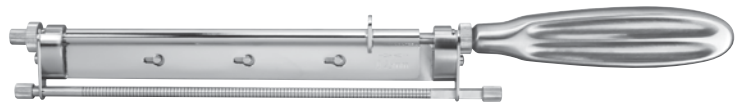

PM-4598

### Sterile Blades, 10 Pack

Catalog#	Description	Length
PM-4596	For Skin Graft Knives PM-4597, PM-4597LH, PM-4598	6-1/4" (159 mm)



PM-4596

### USF Debriding Forceps, Angled Jaws

USF Debriding Forceps have angled jaws for optimized visualization and control during procedures. They are specially designed for blunt debridement of a burn or wound. The blunt tip and side blades help prevent damage to viable skin.

Catalog#	Length
PM-8632	7" (178 mm)

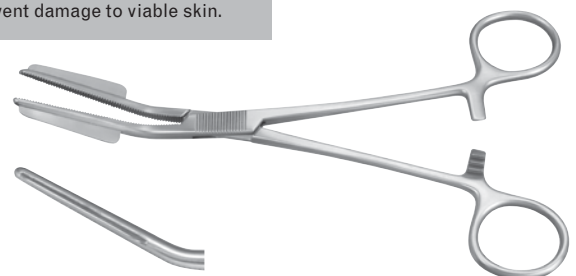

PM-8632

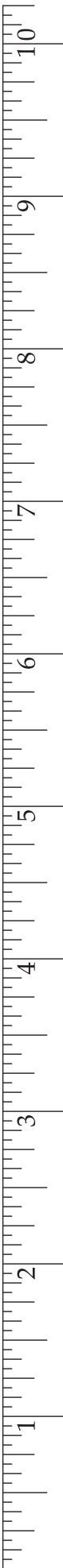

# MALLETS AND CARTILAGE INSTRUMENTS



Mallets  
Cartilage Instruments  
Morselizers

### Quisling Intranasal Hammer

Catalog#	Length
PM-3780	6-3/4" (171 mm)



PM-3780

### Gerzog Mallet

Catalog#	Description	Length	Diameter
19-790*	Head 8 oz. (227g) Lead Filled with Stainless Steel Jacket	7-1/2" (191 mm)	1-1/2" (38 mm)

\*Miltex® Brand

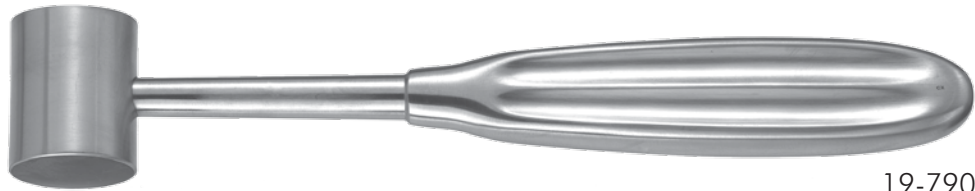

19-790

### Kirk Mallet

Catalog#	Description	Length	Diameter
PM-3779	1 lb. 2 oz. (510g)	7-3/4" (197 mm)	1-1/2" (38 mm)

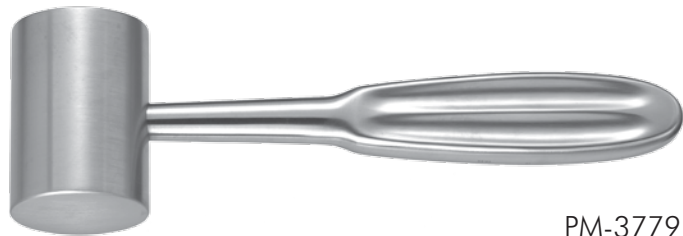

PM-3779

### Padgett Nasal and Orthopedic Mallet

Catalog#	Description	Length	Diameter
PM-4398	With Replacable Bakelite Caps	7-1/4" (184 mm)	1" (25 mm)
PM-4398R	6 oz. (170g) Replacement Bakelite Cap for PM-4398	-	1" (25 mm)

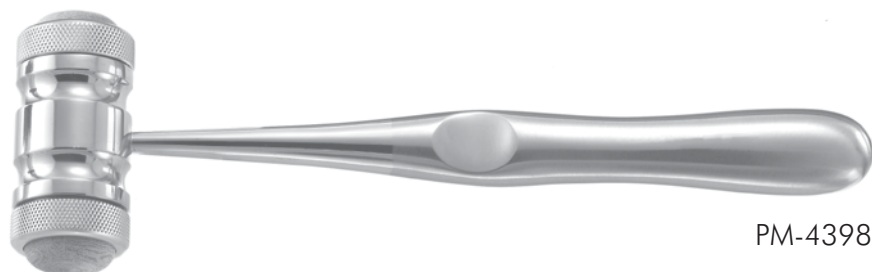

PM-4398

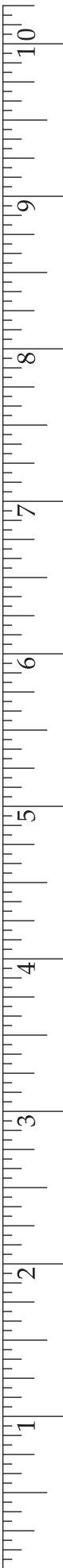

### Fowler Aluminum Mallet

Catalog#	Description	Length	Diameter
PM-805	10 oz. (284g)	7-3/4" (197 mm)	1-1/2" (38 mm)

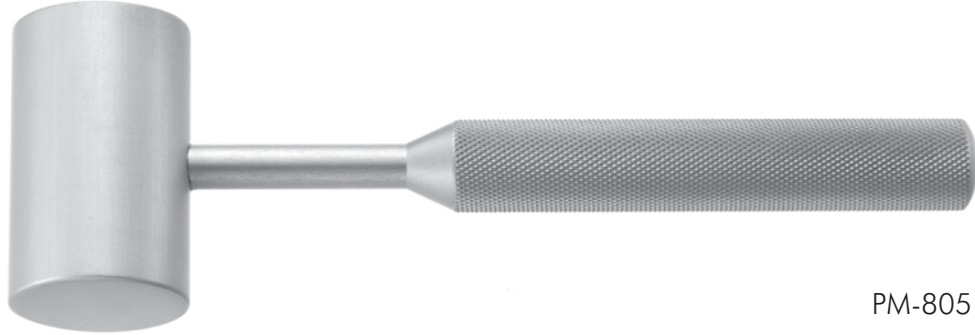

PM-805

### Lucae Mallet

Catalog#	Description	Length	Diameter
19-792*	Head 9 oz. (255g) Solid Stainless Steel	7-3/4" (197 mm)	1" (25 mm)



\*Miltex® Brand

19-792

### Mallet

Catalog#	Description	Length	Diameter
PM-1492	Solid Stainless Steel, 3/4 lb. (340g)	7-3/4" (197 mm)	1-1/4" (32 mm)



PM-1492

### Mead Mallet

Catalog#	Description	Length	Diameter
19-796*	Head 8 oz. (227g) with 2 Replaceable Nylon Caps	7-1/2" (191 mm)	1" (25 mm)
19-797*	Replacement Nylon Cap for 19-796		1" (25 mm)

\*Miltex® Brand

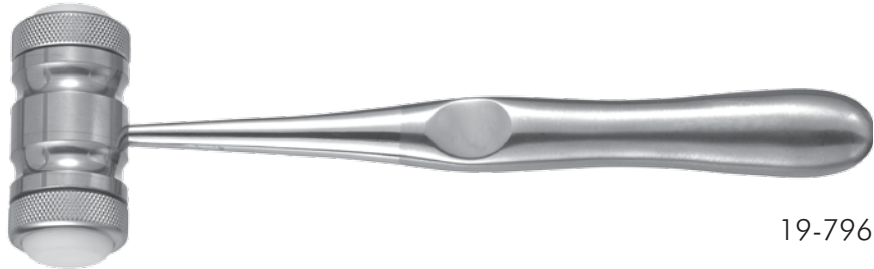

19-796

### Padgett and Miltex Nasal Mallets

Catalog#	Description	Length	Diameter
PM-4984	Head 4 oz. (113g) with 2 Replaceable Nylon Caps	7-3/8" (187 mm)	1" (25 mm)
PM-4984R	Replacement Cap for PM-4984		1" (25 mm)
19-793*	Head 7.5 oz. (213g) with 2 Replaceable Nylon Caps	7-1/2" (191 mm)	1" (25 mm)
19-794*	Head 9 oz. (255g) with 1 Stainless Face and 1 Replaceable Nylon Cap	7-1/2" (191 mm)	1" (25 mm)
19-795*	Replacement Cap for 19-793 and 19-794		1" (25 mm)

\*Miltex® Brand



PM-4984R

19-794

PM-4984

### Sherman Nasal Mallet

Catalog#	Description	Length	Diameter
PM-4900	2.5 oz. (71g) Copper Head	7-1/8" (181 mm)	3/4" (19 mm)



PM-4900



### Cottle Cartilage Crusher

Catalog#	Description	Length	Width
PM-666	Smooth Bed	2-3/4" (70 mm)	15 mm
PM-667	Serrated Bed	2-3/4" (70 mm)	15 mm
21-300*	Smooth Bed	2-3/4" (70 mm)	16 mm

\*Miltex® Brand

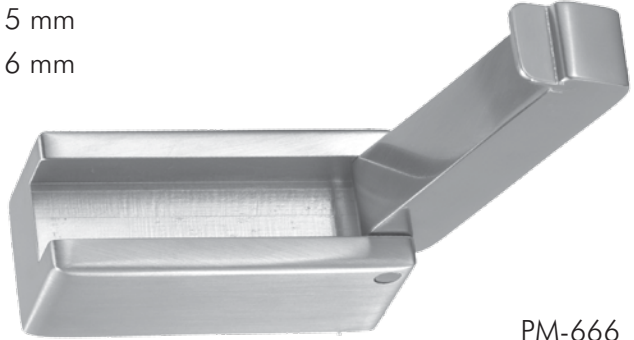

PM-666

### Jost Cartilage Crusher

Catalog#	Bed
PM-3575	64 mm x 32 mm

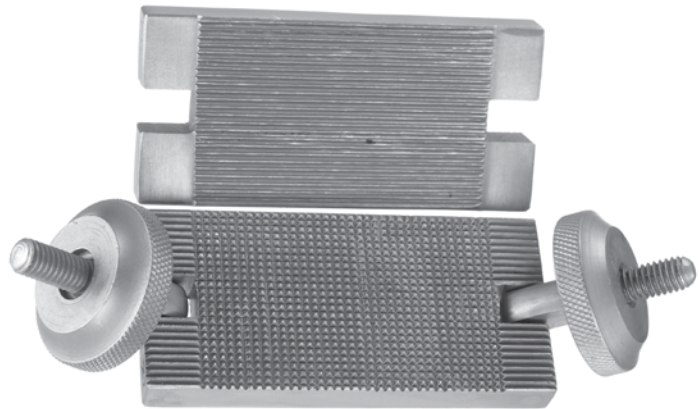

PM-3575

### Bone Grinder

Catalog#	Bed
62-70*	50 mm x 30 mm

\*Miltex® Brand

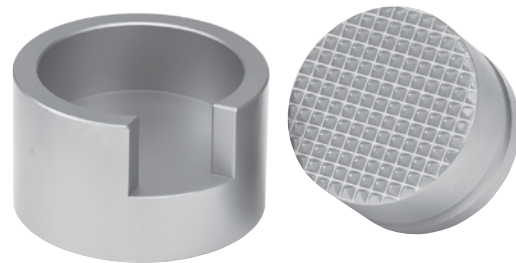

62-70





### Lower Lateral Cartilage Morselizer

Catalog#	Description	Jaw	Length
PM-3819	1 - Smooth Jaw and 1 - Serrated Jaw with Pyramid Shaped Teeth	4.3 mm x 9.5 mm	7-1/2" (191 mm)

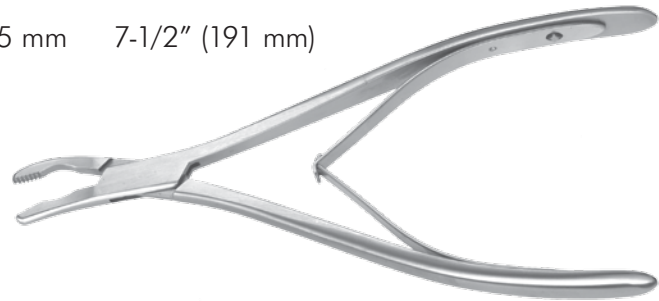

PM-3819

### Rubin Septal Morselizer, Double Action

Catalog#	Description	Jaw	Length
20-552*	Angled Handles, Serrated Jaws with Pyramid Shaped Teeth and Clip	17 mm x 5 mm	8" (203 mm)
20-553*	Replacement Slip-On Clip for 20-552		



20-552

\*Miltex® Brand

### Padgett-Rubin Morselizer, Double Action

Catalog#	Description	Jaw	Length
PM-3830	Angled Handles, Serrated Jaws with Pyramid Shaped Teeth and Clip	16 mm x 5 mm	8-1/4" (210 mm)
PM-3831	Replacement Slip On Clip for PM-3830		



PM-3830

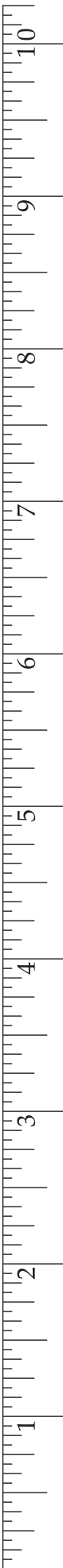

### Wright-Rubin Septum Morselizer

Catalog#	Description	Jaw	Length
20-550*	Straight, Long Serrated Jaws with Pyramid Shaped Teeth and Clip	20 mm x 5 mm	8-1/2" (214 mm)
20-553*	Replacement Slip-On Clip for 20-550		

\*Miltex® Brand



20-550

### Gorney Septal Morselizer, Double Action, Tungsten Carbide

Catalog#	Description	Length
PM-2215	Angled Handles, Tungsten Carbide Jaws with Smooth Clip, One Jaw is Serrated with Pyramid Shaped Teeth and other Jaw has Semi-Sharp Longitudinal Ridges	8-1/2" (216 mm)



PM-2215

### Gunter Lower Lateral Morselizer, Tungsten Carbide

Catalog#	Description	Length
PM-2216	Tungsten Carbide Jaws, 1-Smooth Jaw and 1-Serrated Jaw with Pyramid Shaped Teeth	7" (178 mm)
PM-2211	Tungsten Carbide Jaws with Semi-Sharp Longitudinal Ridges	7" (178 mm)

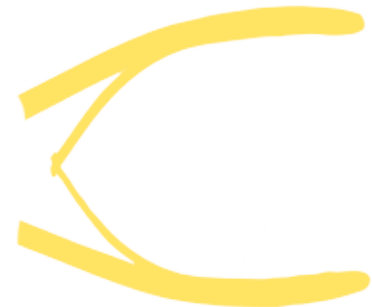

PM-2216

# NEEDLE HOLDERS



The Miltex Repair and Service Team offer extensive instrument refurbishment and Tungsten Carbide jaw replacement services. Contact us for more information.

## ANATOMY OF PADGETT® AND MILTEX® NEEDLE HOLDERS

### Tungsten Carbide Jaws

Tungsten Carbide jaws are bonded to needle holders made from the finest quality stainless steel.

These jaws are custom crafted with teeth ranging from 2,600 per square inch to 16,000 per square inch, according to the size of the instrument and the sizes of needles and sutures. Needle holder patterns are also available with smooth Tungsten Carbide jaws, designed to hold the smallest sutures in micro-surgical and plastic surgery procedures.

The jaw edge is chamfered to prevent accidental cutting of suture material.

### TEETH

Teeth are precision milled into the Tungsten Carbide, forming sharp pyramid-shapes to provide a positive non-slip surface.

### BOX LOCK

The edges around the box lock have distinct non-catch bevels, preventing fraying of suture material.

### LASER ETCHING

All Miltex needle holders are laser etched with our logo and catalog number for easy re-ordering. Advanced laser techniques are used and will not harm or damage the instrument as did older and traditional acid etching techniques.

### SATIN FINISH

Each instrument is satin finished to reduce glare.

### RING HANDLES

Well rounded and polished for better "feel and comfort" as well as prevention of hand fatigue. Gold-plated ring handles help to identify these precision instruments.

*\* Note: cold or chemical sterilization is not recommended for Tungsten Carbide instruments*



### Baumgartner Needle Holder, Tungsten Carbide

Catalog#	Description	Length
PM-2110	Serrated Jaws	5-1/2" (140 mm)
8-40TC*	Serrated Jaws	5-1/2" (140 mm)

\*Miltex® Brand



PM-2110

### Carroll Wire Twister, Tungsten Carbide

Catalog#	Description	Length	Jaw Width
PM-2121	Heavy Serrated Jaws, Delicate	6" (152 mm)	3 mm
PM-2122	Heavy Serrated Jaws, Blunt	6" (152 mm)	4 mm



PM-2121

### Wire Twister, Tungsten Carbide

Catalog#	Description	Length
22-500TC	Heavy Serrated Jaws	6" (152 mm)
22-502TC	Heavy Serrated Jaws	8" (203 mm)

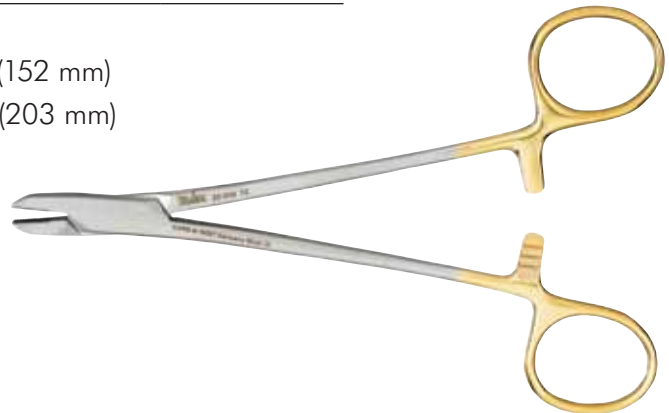

22-500TC

### Corwin Wire Twister, Tungsten Carbide

Catalog#	Description	Length
PM-2123	Serrated Jaws	6" (152 mm)



PM-2123

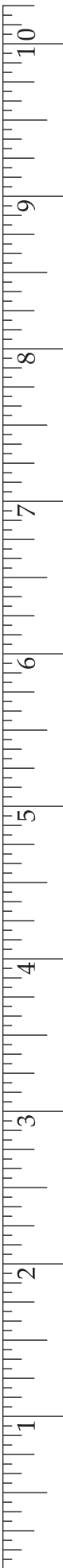

### Mayo-Hegar Needle Holder, Tungsten Carbide

Catalog#	Description	Length
8-42TC*	Serrated Jaws	5" (127 mm)
PM-2120	Serrated Jaws	6" (152 mm)
8-44TC*	Serrated Jaws	6-1/4" (159 mm)
PM-2130	Serrated Jaws	7" (178 mm)
8-46TC*	Serrated Jaws	7-1/4" (184 mm)
PM-2140	Serrated Jaws	8" (203 mm)
8-48TC*	Serrated Jaws	8" (203 mm)
PM-2145	Serrated Jaws	9-1/2" (241 mm)
8-130TC*	Serrated Jaws	10-1/2" (267 mm)
8-49TC*	Serrated Jaws	12" (305 mm)



PM-2130

\*Miltex® Brand

### Mayo-Hegar Needle Holder, Left-Handed, Tungsten Carbide

Catalog#	Description	Length
8-744TC*	Serrated Jaws, Left-Handed	6" (152 mm)
8-746TC*	Serrated Jaws, Left-Handed	7" (178 mm)
8-748TC*	Serrated Jaws, Left-Handed	8" (203 mm)



8-744TC

\*Miltex® Brand

### Olsen-Hegar Needle Holder & Suture Scissors, Tungsten Carbide

Catalog#	Description	Length
PM-2165	Smooth Jaws	4-3/4" (121 mm)
8-14A-TC*	Smooth Jaws	4-3/4" (121 mm)
PM-2169	Serrated Jaws	4-3/4" (121 mm)
8-14TC*	Serrated Jaws	4-3/4" (121 mm)
PM-3160	Smooth Jaws	5-1/2" (140 mm)
PM-2160	Serrated Jaws	5-1/2" (140 mm)
8-15TC*	Serrated Jaws	5-1/2" (140 mm)
PM-2170	Serrated Jaws	6-1/2" (165 mm)
8-16TC*	Serrated Jaws	6-1/2" (165 mm)
8-17TC*	Serrated Jaws	7-1/2" (191 mm)



PM-2169

\*Miltex® Brand

### Crile-Wood Needle Holder, Tungsten Carbide

Catalog#	Description	Length
PM-2430	Serrated Jaws	6" (152 mm)
8-50TC*	Serrated Jaws	6" (152 mm)
PM-2435	Smooth Jaws	6" (152 mm)
8-50A-TC*	Smooth Jaws	6" (152 mm)
PM-2320	Serrated Jaws	7" (178 mm)
8-51TC*	Serrated Jaws	7" (178 mm)
PM-2321	Curved, Serrated Jaws	7" (178 mm)
PM-2325	Serrated Jaws	8" (203 mm)
8-52TC*	Serrated Jaws	8" (203 mm)
PM-2350	Serrated Jaws	9" (229 mm)
8-53TC*	Serrated Jaws	9" (229 mm)
PM-2360	Curved, Serrated Jaws	9" (229 mm)
8-55TC*	Serrated Jaws	10-1/2" (267 mm)
8-57TC*	Serrated Jaws	12" (305 mm)



PM-2430

\*Miltex® Brand

### Crile-Wood Needle Holder, Left-Handed, Tungsten Carbide

Catalog#	Description	Length
PM-2435LH	Smooth Jaws, Left-Handed	6" (152 mm)
8-750TC*	Serrated Jaws, Left-Handed	6" (152 mm)
8-751TC*	Serrated Jaws, Left-Handed	7" (178 mm)
8-752TC*	Serrated Jaws, Left-Handed	8" (203 mm)
8-753TC*	Serrated Jaws, Left-Handed	9" (229 mm)



PM-2435LH

\*Miltex® Brand

### Derf Needle Holder, Tungsten Carbide

Catalog#	Description	Length
PM-2400	Serrated Jaws	4-3/4" (121 mm)
8-4TC*	Serrated Jaws	4-3/4" (121 mm)



PM-2400

\*Miltex® Brand



### Webster Needle Holder, Tungsten Carbide

Catalog#	Description	Length
PM-2405	Delicate Smooth Jaws	4-3/4" (121 mm)
8-6TC*	Delicate Smooth Jaws	5-1/4" (133 mm)
8-7TC*	Extra Delicate Smooth Jaws	4-3/4" (121 mm)
8-7A-TC*	Extra Delicate Serrated Jaws	4-3/4" (121 mm)
8-706TC*	Smooth Jaws, Left-Handed	5" (127 mm)

\*Miltex® Brand

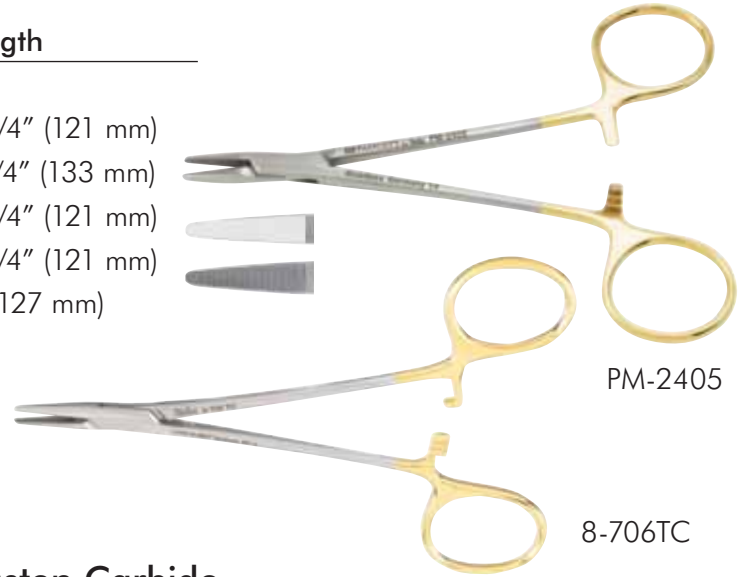

### Micro Vascular Needle Holder, Tungsten Carbide

Catalog#	Description	Length
PM-2431	Serrated Jaws	6" (152 mm)
PM-2322	Serrated Jaws	7" (178 mm)
PM-2322SJ	Smooth Jaws	7" (178 mm)



### Halsey Needle Holder, Tungsten Carbide

Catalog#	Description	Length
PM-2410	Serrated Jaws	5" (127 mm)
8-8TC*	Smooth Jaws	5" (127 mm)
PM-2410LH	Serrated Jaws, Left-Handed	5" (127 mm)
PM-2415	Smooth Jaws	5" (127 mm)
8-8A-TC*	Serrated Jaws	5" (127 mm)
PM-2415LH	Smooth Jaws, Left-Handed	5" (127 mm)

\*Miltex® Brand





### Par Needle Holder, Tungsten Carbide

Catalog#	Description	Length
8-3TC*	Delicate, Serrated Jaws	4-1/2" (114 mm)
PM-2404	Delicate, Serrated Jaws	4-3/4" (121 mm)
8-5TC*	Delicate, Serrated Jaws	5" (127 mm)
PM-2414	Delicate, Serrated Jaws	5-1/4" (133 mm)

\*Miltex® Brand



PM-2404

### Neivert Needle Holder, Tungsten Carbide

Catalog#	Description	Length
PM-2420	Serrated Jaws, One Angled & Offset Ring	5" (127 mm)



PM-2420

### Gillies Needle Holder & Suture Scissors, Tungsten Carbide

Catalog#	Description	Length
PM-2425	Serrated & Curved Jaws Angled and Offset Larger Finger Ring on Short Shank Design	6-1/4" (159 mm)



PM-2425

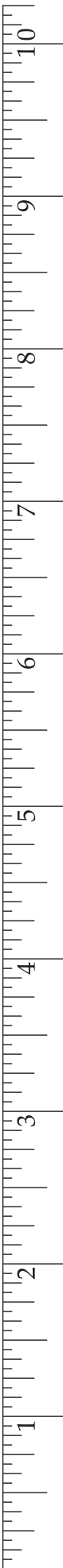

### Swedish Needle Holder, Tungsten Carbide

Catalog#	Description	Length
----------	-------------	--------

PM-2426	Straight, Delicate Serrated Jaws and Very Light Shanks	6" (152 mm)
---------	--	-------------

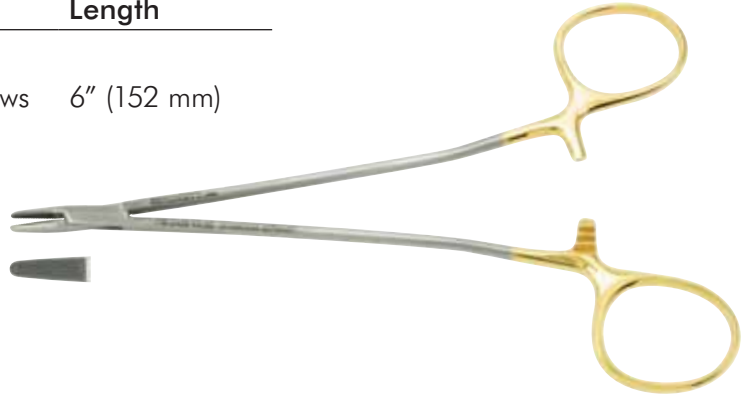

PM-2426

### Cooley Needle Holder, Tungsten Carbide

Catalog#	Description	Length
----------	-------------	--------

8-62TC*	Extra Delicate Serrated Jaws	6" (152 mm)
8-63TC*	Extra Delicate Serrated Jaws	6-3/4" (171 mm)

\*Miltex® Brand

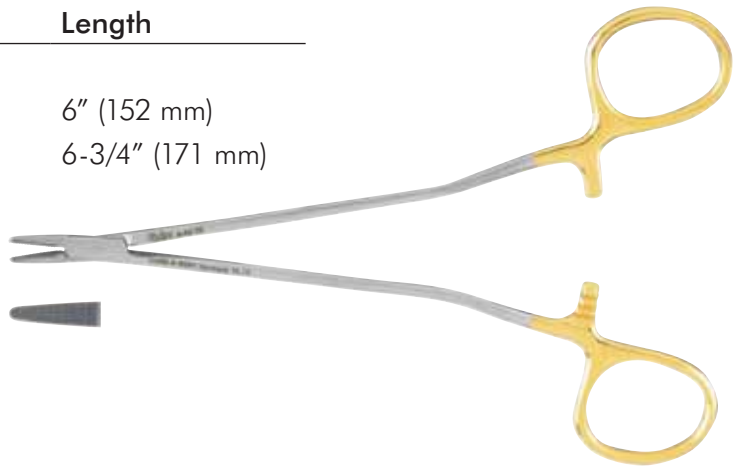

8-62TC

### Parkhouse Needle Holder & Suture Scissors, Tungsten Carbide

Catalog#	Description	Length
----------	-------------	--------

PM-2424	Serrated Jaws with Offset Finger Ring	5-1/2" (140 mm)
---------	---------------------------------------	-----------------



PM-2424

### Castroviejo Needle Holder, Tungsten Carbide

Catalog#	Description	Length
PM-2440	Straight, Serrated Jaws, with Lock	5-1/2" (140 mm)
18-1828A-TC*	Straight, Serrated Jaws, with Lock	5-1/2" (140 mm)
PM-2442	Straight, Serrated Jaws, with Lock	8-1/2" (216 mm)
PM-2445	Straight, Smooth Jaws, with Lock	5-1/2" (140 mm)
18-1828TC*	Straight, Smooth Jaws, with Lock	5-1/2" (140 mm)
PM-2447	Straight, Smooth Jaws, with Lock	8-1/2" (216 mm)
PM-2441	Curved, Serrated Jaws, with Lock	5-1/2" (140 mm)
18-1832A-TC	Curved, Serrated Jaws, with Lock	5-1/2" (140 mm)
PM-2446	Curved, Smooth Jaws, with Lock	5-1/2" (140 mm)
18-1832TC*	Curved, Smooth Jaws, with Lock	5-1/2" (140 mm)

\*Miltex® Brand



PM-2440

### Ryder Needle Holder, Tungsten Carbide

Catalog#	Description	Length
PM-2406	Serrated Jaws	5" (127 mm)
8-101TC*	Serrated Jaws	5" (127 mm)
PM-3710	Neurosurgical, Smooth Jaws	5" (127 mm)
PM-2416	Neurosurgical, Smooth Jaws	5-1/4" (133 mm)
PM-2206	Serrated Jaws	5-3/4" (146 mm)
PM-2200	Serrated Jaws	6-1/4" (159 mm)
PM-3715	Smooth Jaws	6" (152 mm)
8-103TC*	Serrated Jaws	6" (152 mm)
PM-3720	Smooth Jaws	7" (178 mm)
8-104TC*	Serrated Jaws	7" (178 mm)
PM-2220	Serrated Jaws	8" (203 mm)
8-105TC*	Serrated Jaws	8" (203 mm)
8-106TC*	Serrated Jaws	9" (229 mm)
PM-2290	Serrated Jaws	10" (254 mm)
8-107TC*	Serrated Jaws	10-1/4" (260 mm)

\*Miltex® Brand



PM-2406



PM-3710

### Ryder-Type Intracardiac Needle Holder, Tungsten Carbide

Catalog#	Description	Length
8-65TC*	Extra Delicate, Serrated Jaws	5" (127 mm)
8-66TC*	Extra Delicate, Serrated Jaws	6" (152 mm)
8-67TC*	Extra Delicate, Serrated Jaws	7" (178 mm)
8-69TC*	Extra Delicate, Serrated Jaws	9" (229 mm)

\*Miltex® Brand



8-65TC

### Mathieu Needle Holder, Tungsten Carbide

Catalog#	Description	Length
8-28TC*	Serrated Jaws	5-1/2" (140 mm)
8-30TC*	Serrated Jaws	6-1/4" (159 mm)

\*Miltex® Brand



8-28TC

### Julian Needle Holder, Tungsten Carbide

Catalog#	Description	Length
8-82TC*	Serrated Jaws	8-1/4" (210 mm)
8-83TC*	Serrated Jaws, Curved	8-1/4" (210 mm)

\*Miltex® Brand



8-82TC



### Sarot Needle Holder, Tungsten Carbide

Catalog#	Description	Length
----------	-------------	--------

8-96TC*	Serrated Jaws	7-1/4" (184 mm)
8-114TC*	Serrated Jaws	10-1/2" (267 mm)

\*Miltex® Brand

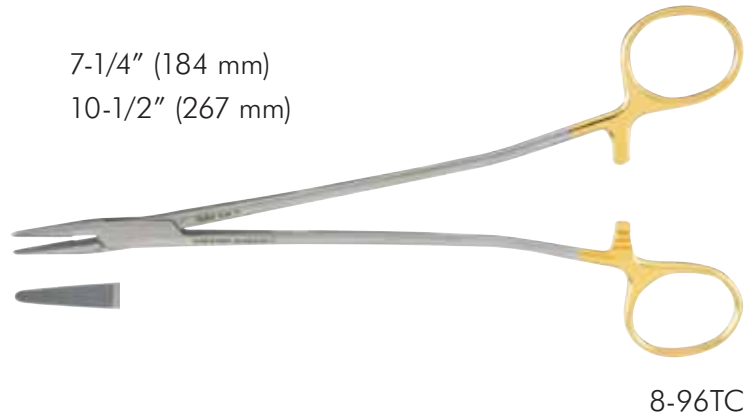

### Heany Needle Holder, Tungsten Carbide

Catalog#	Description	Length
----------	-------------	--------

8-100TC*	Serrated Jaws, Curved	8-1/2" (216 mm)
----------	-----------------------	-----------------

\*Miltex® Brand

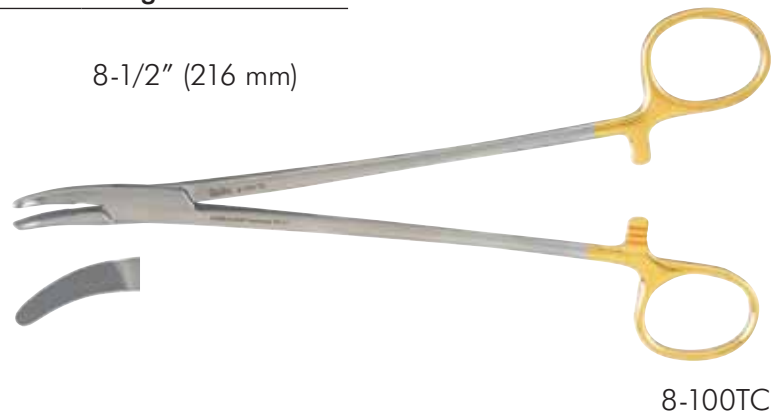

### Stratte Needle Holder, Tungsten Carbide

Catalog#	Description	Length
----------	-------------	--------

8-102TC*	Serrated Jaws, Curved Jaws and Shanks	9" (229 mm)
----------	---------------------------------------	-------------

\*Miltex® Brand

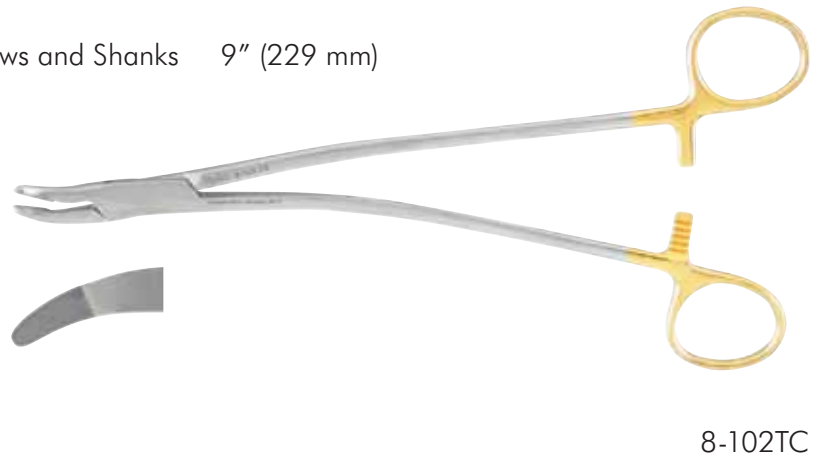

### Wangensteen Needle Holder, Tungsten Carbide

Catalog#	Description	Length
----------	-------------	--------

8-134TC*	Serrated Jaws	10-3/4" (273 mm)
----------	---------------	------------------

\*Miltex® Brand



8-134TC

### Bihrl Needle Holder/Clamp, Tungsten Carbide

Catalog#	Description	Length
----------	-------------	--------

29-310TC*	Serrated and Smooth Jaws	11" (279 mm)
-----------	--------------------------	--------------

\*Miltex® Brand



29-310TC

### Olsen-Hegar Needle Holder with Suture Scissors

Catalog#	Description	Length
8-14*	Extra Delicate, Serrated Jaws	4-3/4" (121 mm)
8-14A*	Extra Delicate, Smooth Jaws	4-3/4" (121 mm)
8-15*	Serrated Jaws	5-1/2" (140 mm)
8-16*	Serrated Jaws	5-1/2" (140 mm)
8-17*	Serrated Jaws	7-1/4" (184 mm)



8-14

\*Miltex® Brand

### Baumgartner Needle Holder

Catalog#	Description	Length
8-40*	Serrated Jaws	5-1/2" (140 mm)



8-40

\*Miltex® Brand

### Mayo-Hegar Needle Holder

Catalog#	Description	Length
8-42*	Serrated Jaws	5" (127 mm)
8-44*	Serrated Jaws	6" (152 mm)
8-46*	Serrated Jaws	7" (178 mm)
8-48*	Serrated Jaws	8" (203 mm)
8-130*	Serrated Jaws	10-1/2" (267 mm)



8-42

\*Miltex® Brand

### Crile-Wood Needle Holder

Catalog#	Description	Length
8-50*	Serrated Jaws	6" (152 mm)
8-51*	Serrated Jaws	7" (178 mm)
8-52*	Serrated Jaws	8" (203 mm)
8-53*	Serrated Jaws	9" (229 mm)



8-50

\*Miltex® Brand

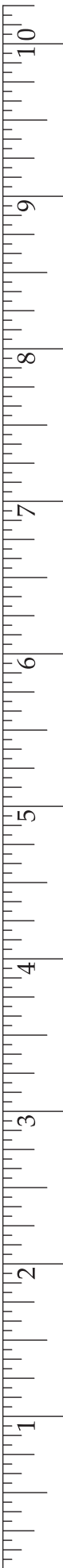



### Webster Needle Holder "Original Pattern"

Catalog#	Description	Length
8-6*	Delicate Smooth Jaws	5" (127 mm)
8-7*	Extra Delicate Smooth Jaws	4-3/4" (121 mm)

\*Miltex® Brand

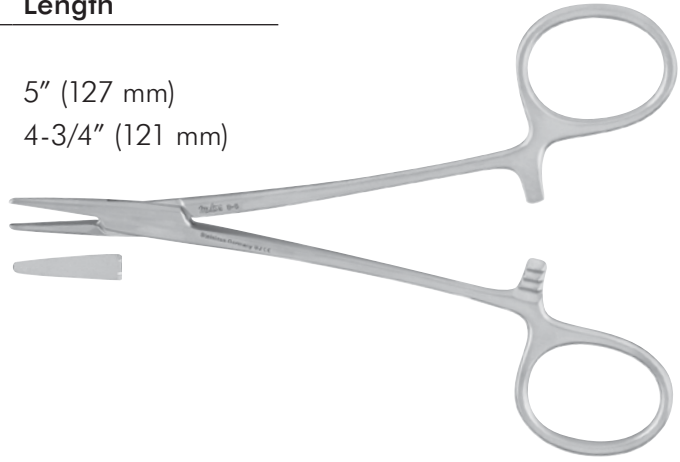

8-6

### Converse Needle Holder

Catalog#	Description	Length
8-20*	Longitudinal Serrations, Large Finger Rings	4-1/4" (108 mm)

\*Miltex® Brand

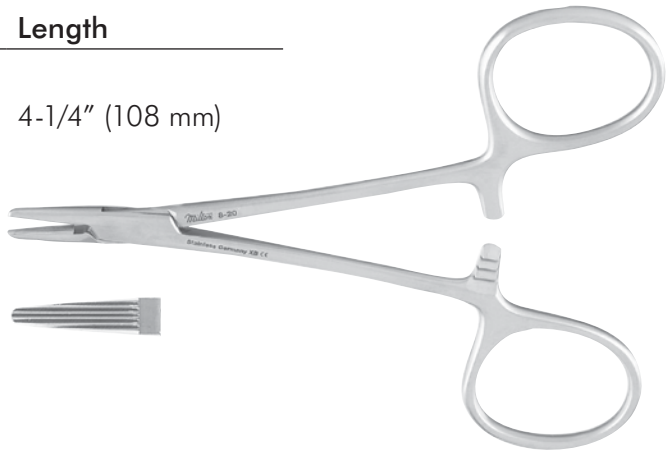

8-20

### Derf Needle Holder

Catalog#	Description	Length
8-4*	Horizontal Serrations	4-3/4" (121 mm)

\*Miltex® Brand

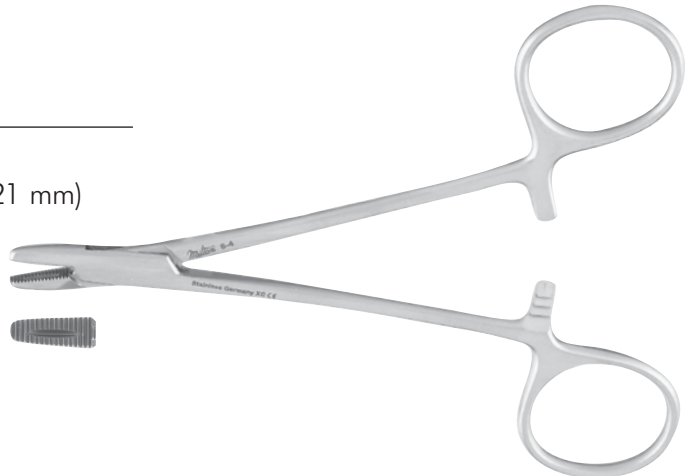

8-4



### Halsey Needle Holder

Catalog#	Description	Length
----------	-------------	--------

8-8*	Smooth Jaws	5" (127 mm)
8D-36*	Serrated Jaws	5" (127 mm)

\*Miltex® Brand



8-8

### Brown Needle Holder

Catalog#	Description	Length
----------	-------------	--------

8-22*	Convex Jaws with Fine Serrations	5-1/4" (133 mm)
8-23*	Convex Jaws with Fine Serrations	6-3/4" (171 mm)

\*Miltex® Brand



8-22

### Neivert Needle Holder

Catalog#	Description	Length
----------	-------------	--------

8-12*	Lightly Serrated Jaws, One Offset Ring	5" (127 mm)
-------	--	-------------

\*Miltex® Brand

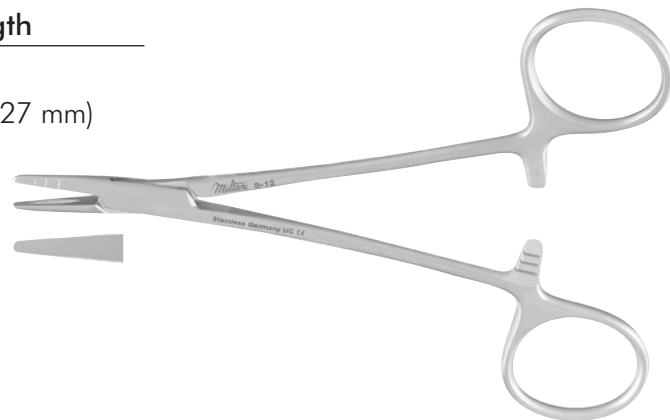

8-12

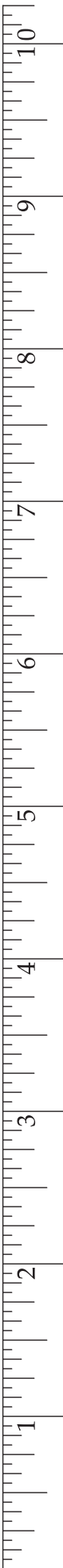

### Noe-Webster Needle Holder

Catalog#	Description	Length
----------	-------------	--------

PM-8335	Inverted Shafts, Smooth Jaws	5" (127 mm)
---------	------------------------------	-------------

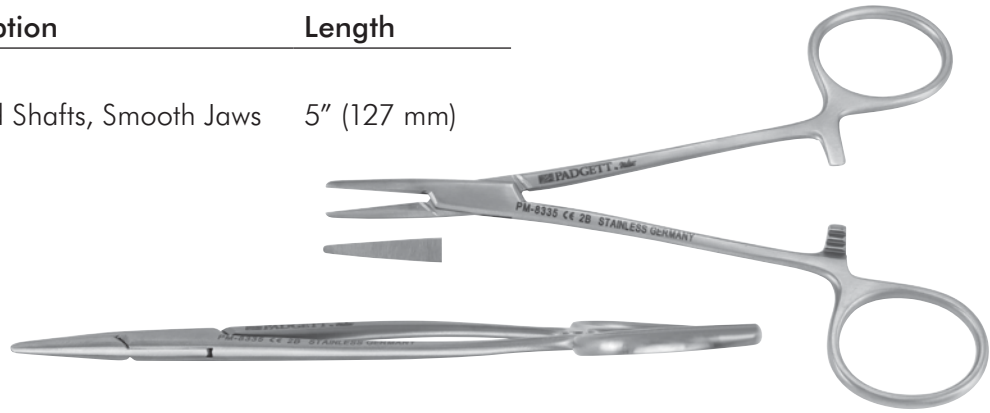

PM-8335

### Metzenbaum Needle Holder

Catalog#	Description	Length
----------	-------------	--------

8-74*	Straight, Fenestrated and Serrated Jaws	7-1/4" (184 mm)
-------	---	-----------------

8-76*	Curved, Fenestrated and Serrated Jaws	7-1/4" (184 mm)
-------	---------------------------------------	-----------------

\*Miltex® Brand



8-74

### Gillies-Sheehan Needle Holder and Suture Scissors

Catalog#	Description	Length
----------	-------------	--------

8-58*	Straight, Serrated, One Fenestrated Jaw and Angled Finger Ring	6-1/2" (165 mm)
-------	--	-----------------

8-59*	Curved, Serrated, One Fenestrated Jaw and Angled Finger Ring	6-1/2" (165 mm)
-------	--	-----------------

\*Miltex® Brand

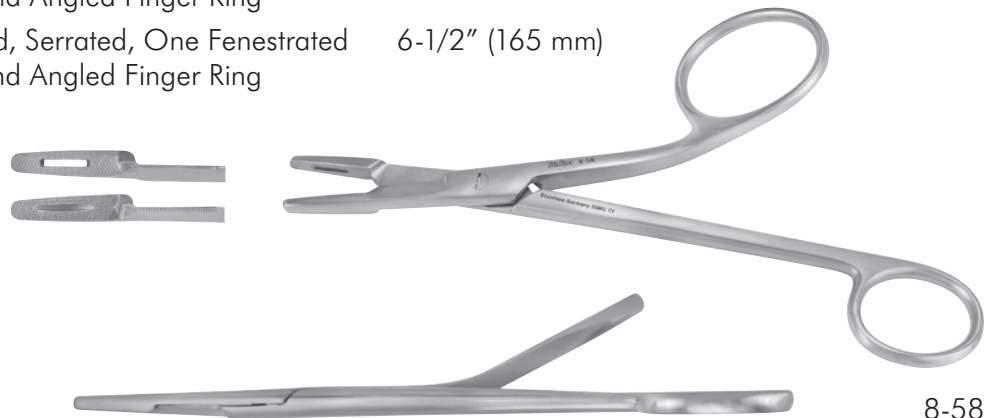

8-58

### Castroviejo Needle Holder

Catalog#	Description	Length
PM-4709	Extra Delicate Smooth Jaws with Lock (Holds 7/0 Sutures)	5-1/2" (140 mm)

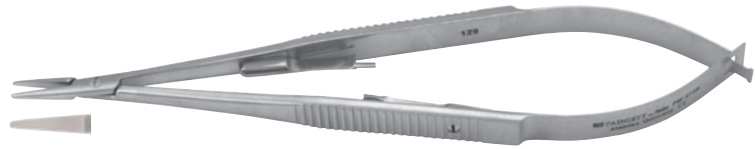

PM-4709

### Castroviejo Micro Surgery Needle Holder

Catalog#	Description	Length
18-1820*	Smooth, Straight Jaws without Lock	5-1/2" (140 mm)
18-1824*	Smooth, Curved Jaws without Lock	5-1/2" (140 mm)
18-1828*	Smooth, Straight Jaws with Lock	5-1/2" (140 mm)
18-1832*	Smooth, Curved Jaws with Lock	5-1/2" (140 mm)
18-1831*	Smooth, Straight Extra Delicate Jaws with Lock	5-1/2" (140 mm)
18-1833*	Smooth, Curved Extra Delicate Jaws with Lock	5-1/2" (140 mm)

\*Miltex® Brand

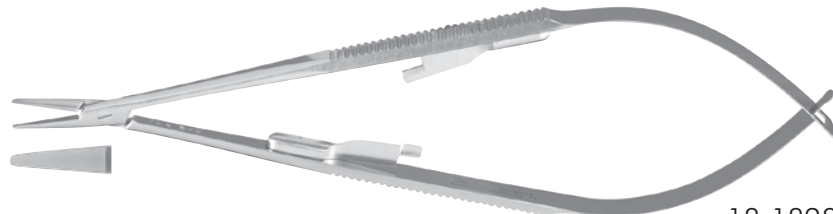

18-1828

### Micro Needle Holder (Round Handles, 0.6 mm Tips)

Catalog#	Description	Length
17-1000*	Smooth, Curved Jaws without Lock	5-1/4" (133 mm)
17-1020*	Smooth, Curved Jaws with Lock	5-1/4" (133 mm)
17-980*	Smooth, Straight Jaws without Lock	7-1/8" (181 mm)
17-1024*	Smooth, Straight Jaws with Lock	7-1/8" (181 mm)
17-1010*	Smooth, Curved Jaws without Lock	7-1/8" (181 mm)
17-1025*	Smooth, Curved Jaws with Lock	7-1/8" (181 mm)

\*Miltex® Brand

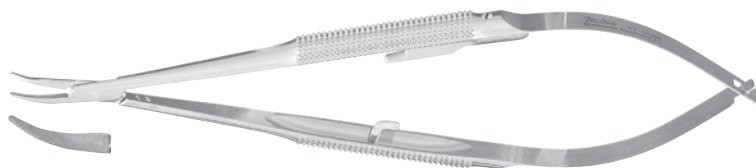

17-1020

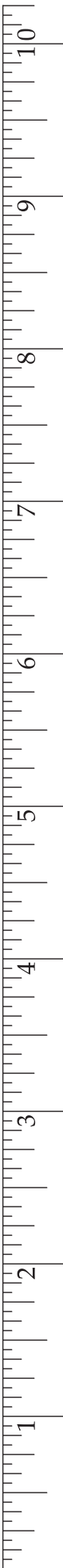

# NEEDLES, PROBES AND PASSERS

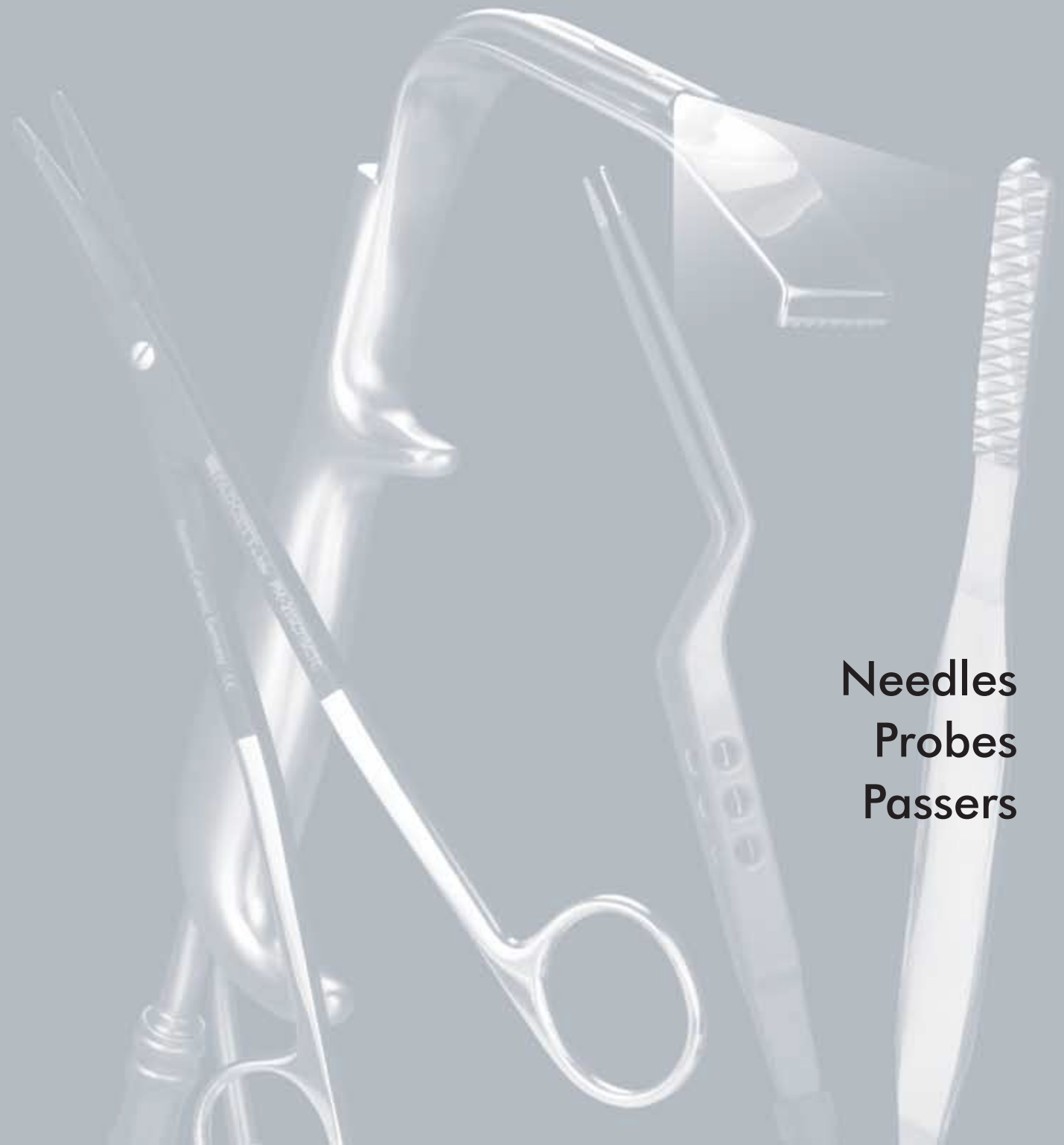

Needles  
Probes  
Passers

### Little Imbrications (Trocar) Needle

**Catalog#**   **Length**

PM-0695   5" (127 mm)



PM-0695

### Framer Tendon Passing Needle

**Catalog#**   **Description**   **Length**

PM-4481   With Eye   6" (152 mm)

PM-4482   Oval Tube with Guide Wire   6" (152 mm)



PM-4481



PM-4482

### Reverdin Suture Needle

**Catalog#**   **Description**   **Length**

PM-4450   No. 1 Curve   5-3/4" (146 mm)

PM-4451   No. 2 Curve   5-3/4" (146 mm)

PM-4452   No. 3 Curve   5-3/4" (146 mm)

PM-4453   No. 4 Curve   5-3/4" (146 mm)

PM-8411   No. 1 Curve   7-1/2" (191 mm)

PM-8412   No. 2 Curve   7-1/2" (191 mm)

PM-8413   No. 3 Curve   7-1/2" (191 mm)

PM-8414   No. 4 Curve   7-1/2" (191 mm)

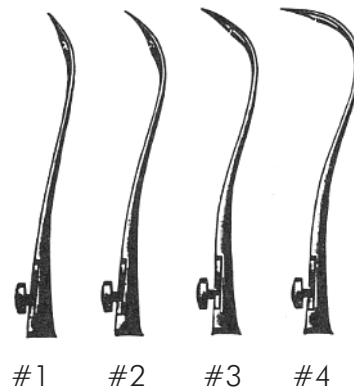

#1   #2   #3   #4



PM-8414

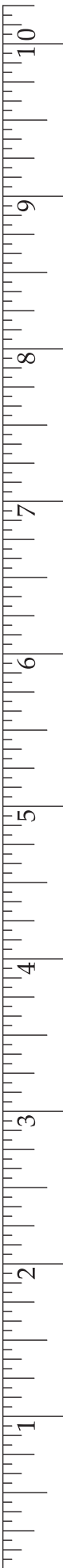



### Kelsey-Fry Bone Awl

Catalog#	Description	Length
PM-1786	Straight with "Eye" for Wire	6" (152 mm)
PM-1788	Curved with "Eye" for Wire	7" (178 mm)



PM-1788

### Obwegeser Awls

Catalog#	Description	Length
21-900*	Mandibular, Slightly Curved	5-1/2" (140 mm)
21-901*	Maxillary, Strong Curve	7" (178 mm)
21-902*	Zygomatic Arch, Slightly Curved	9" (229 mm)

\*Miltex® Brand



21-900

### Tonsil Needles with Luer Lock and Stylet

Catalog#	Description	Length
20-426*	23 Gauge Straight, Extended Needle Length 19 mm	4-1/4" (108 mm)
20-427*	23 Gauge Curved, Extended Needle Length 13 mm	4-1/4" (108 mm)

\*Miltex® Brand



20-426

20-427

### House Needles with Octagonal Handle

Catalog#	Description	Length
19-2500*	Curved Tip, Semi-Sharp Point, Malleable Shaft	6-1/4" (159 mm)
19-2501*	ROSEN Type Curved and Slightly Dulled Tip, Malleable Shaft	6-1/4" (159 mm)

\*Miltex® Brand



19-2500

19-2501

### Bowman Double-Ended Probe

Catalog#	Description	Length
18-740*	Sterling Silver, Sizes 0000 & 000	5" (127 mm)
18-742*	Sterling Silver, Sizes 00 & 0	5" (127 mm)
18-744*	Sterling Silver, Sizes 1 & 2	5" (127 mm)
18-746*	Sterling Silver, Sizes 3 & 4	5" (127 mm)
18-748*	Sterling Silver, Sizes 5 & 6	5" (127 mm)
18-750*	Sterling Silver, Sizes 7 & 8	5" (127 mm)

\*Miltex® Brand

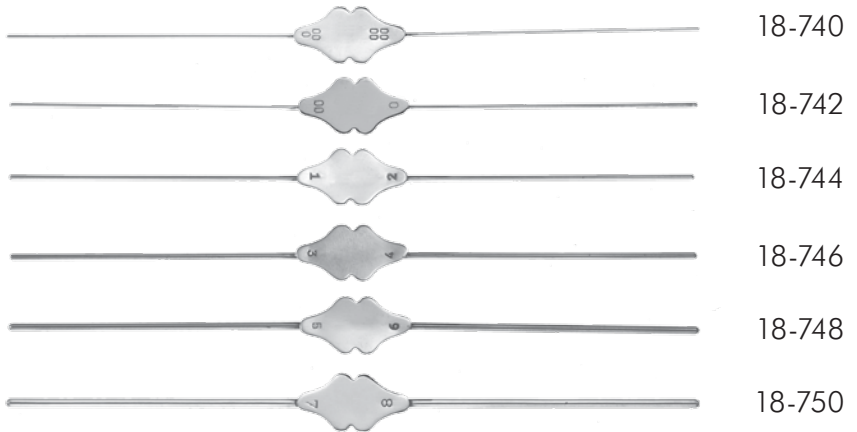

### French Pattern Lacrimal Probes

Catalog#	Description	Length
18-710*	Bayonet Shape, Size 00	5" (127 mm)
18-712*	Bayonet Shape, Size 0	5" (127 mm)
18-714*	Bayonet Shape, Size 1	5" (127 mm)
18-716*	Bayonet Shape, Size 2	5" (127 mm)
18-718*	Bayonet Shape, Size 3	5" (127 mm)
18-720*	Bayonet Shape, Size 4	5" (127 mm)

\*Miltex® Brand

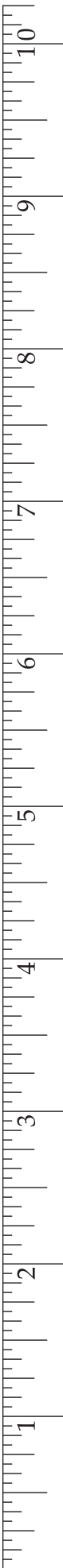
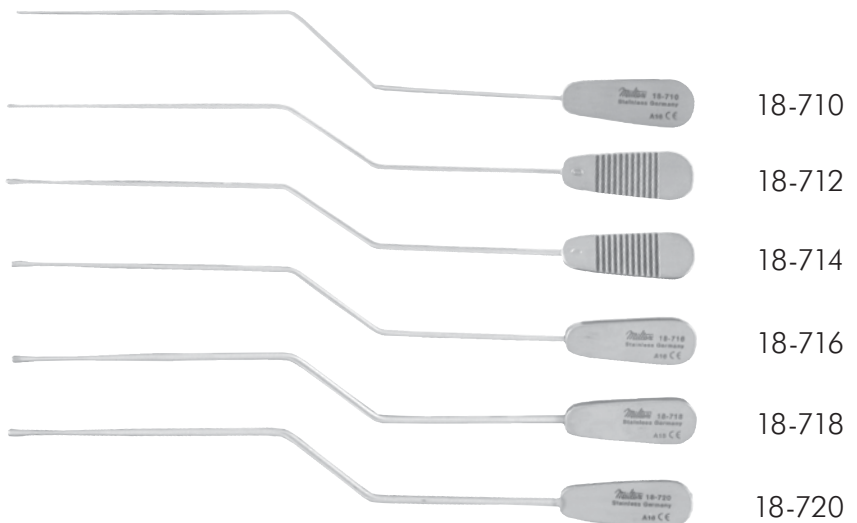

### Williams Lacrimal Probes, Double-Ended

Catalog#	Description	Length
18-722*	Sterling Silver, Size 000-000	5" (127 mm)
18-724*	Sterling Silver, Size 000-0	5" (127 mm)
18-726*	Sterling Silver, Size 1-2	5" (127 mm)
18-728*	Sterling Silver, Size 3-4	5" (127 mm)
18-730*	Sterling Silver, Size 5-6	5" (127 mm)
18-732*	Sterling Silver, Size 7-8	5" (127 mm)

\*Miltex® Brand

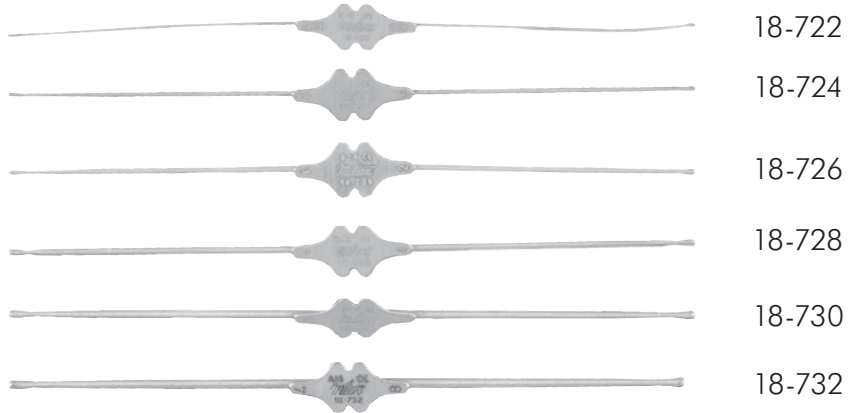

### Probe with Eye, Malleable

Catalog#	Description	Length
10-22-SS*	Stainless	4-1/2" (114 mm)
10-22-ST*	Sterling	4-1/2" (114 mm)
10-24-SS*	Stainless	5" (127 mm)
10-24-ST*	Sterling	5" (127 mm)
10-26-SS*	Stainless	5-1/2" (140 mm)
10-26-ST*	Sterling	5-1/2" (140 mm)
10-28-SS*	Stainless	6" (152 mm)
10-28-ST*	Sterling	6" (152 mm)
10-30-SS*	Stainless	7" (178 mm)
10-30-ST*	Sterling	7" (178 mm)
10-32-SS*	Stainless	8" (203 mm)
10-32-ST*	Sterling	8" (203 mm)
10-34-SS*	Stainless	10" (254 mm)
10-34-ST*	Sterling	10" (254 mm)

\*Miltex® Brand

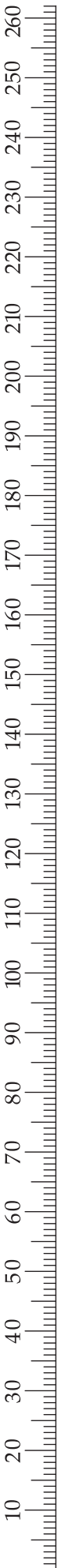



### Probes, Double-Ended, Malleable

Catalog#	Description	Length
10-2-NS*	Nickel Silver	4-1/2" (114 mm)
10-2-ST*	Sterling Silver	4-1/2" (114 mm)
10-4-NS*	Nickel Silver	5" (127 mm)
10-4-ST*	Sterling Silver	5" (127 mm)
10-6-NS*	Nickel Silver	5-1/2" (140 mm)
10-6-ST*	Sterling Silver	5-1/2" (140 mm)
10-8-NS*	Nickel Silver	6" (152 mm)
10-8-ST*	Sterling Silver	6" (152 mm)
10-10-NS*	Nickel Silver	7" (178 mm)
10-10-ST*	Sterling Silver	7" (178 mm)
10-12-NS*	Nickel Silver	8" (203 mm)
10-12-ST*	Sterling Silver	8" (203 mm)
10-14-NS*	Nickel Silver	10" (254 mm)
10-14-ST*	Sterling Silver	10" (254 mm)

\*Miltex® Brand



10-2-NS

### Grooved Directors

Catalog#	Description	Length
10-69*	With Tongue Tie	4-1/2" (114 mm)
10-79*	With Probe Tip and Tongue Tie	4-1/2" (114 mm)
10-70*	With Tongue Tie	5" (127 mm)
10-80*	With Probe Tip and Tongue Tie	5" (127 mm)
10-72*	With Tongue Tie	5-1/2" (140 mm)
10-82*	With Probe Tip and Tongue Tie	5-1/2" (140 mm)
10-74*	With Tongue Tie	6" (152 mm)
10-84*	With Probe Tip and Tongue Tie	6" (152 mm)
10-76*	With Tongue Tie	8" (203 mm)

\*Miltex® Brand



10-84



10-76

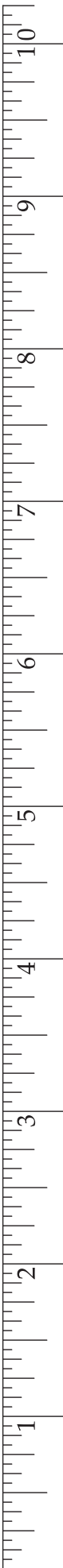

## Worst Pigtail Probe

Catalog#	Description	Length
PM-4739HK	With Hook and a Spiraled Probe	6-1/4" (159 mm)
PM-4739HL	With Hole and Silicone Cannula	6-1/4" (159 mm)
PM-4740	Spare Silicone Tubing for PM-4739HK & HL	

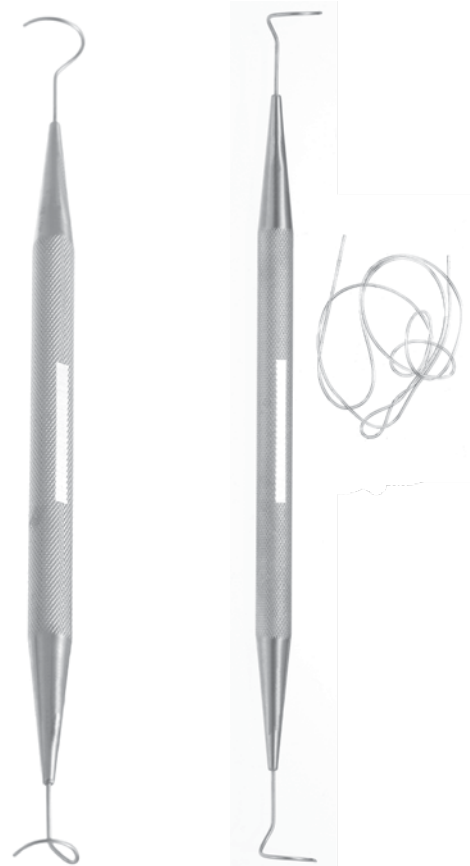
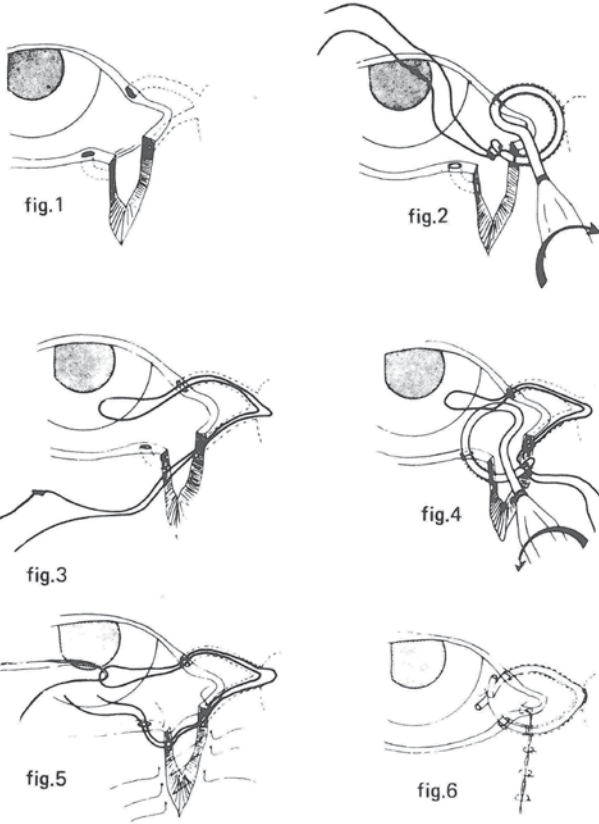

PM-4739HK

PM-4739HL



### Malleable Suture Passer

Catalog#    Length

PM-229    9" (229 mm)



PM-229

### Bunnell Tendon Passer and Probe

Catalog#    Length

PM-4912    7-1/4" (184 mm)

PM-4913    8-7/8" (225 mm)



PM-4912

### Dingman Wire Passer

Catalog#    Description    Length

PM-406    Curved    6-3/4" (171 mm)



PM-406

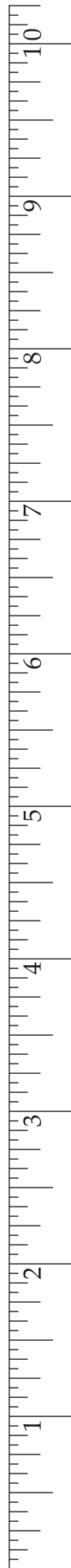

# **RASPS, FILES AND SAWS**



**Tungsten Carbide Rasps  
Standard Rasps  
Files  
Saws**

### Padgett Nasal Rasp, Tungsten Carbide

Catalog#	Description	Length	Width
PM-2031	Double-Ended, Forward & Reverse Cutting, 3 & 4 Grits	8" (203 mm)	6.8 mm
PM-2032	Double-Ended, Forward & Reverse Cutting, 5 & 6 Grits	8" (203 mm)	6.8 mm
PM-2035	Double-Ended, Forward & Reverse Cutting, 5 & 7 Grits	8" (203 mm)	6.8 mm
PM-2033	Double-Ended, Forward & Reverse Cutting, 7 & 8 Grits	8" (203 mm)	6.8 mm
PM-2034	Double-Ended, Forward & Reverse Cutting, 9 & 10 Grits	8" (203 mm)	6.8 mm

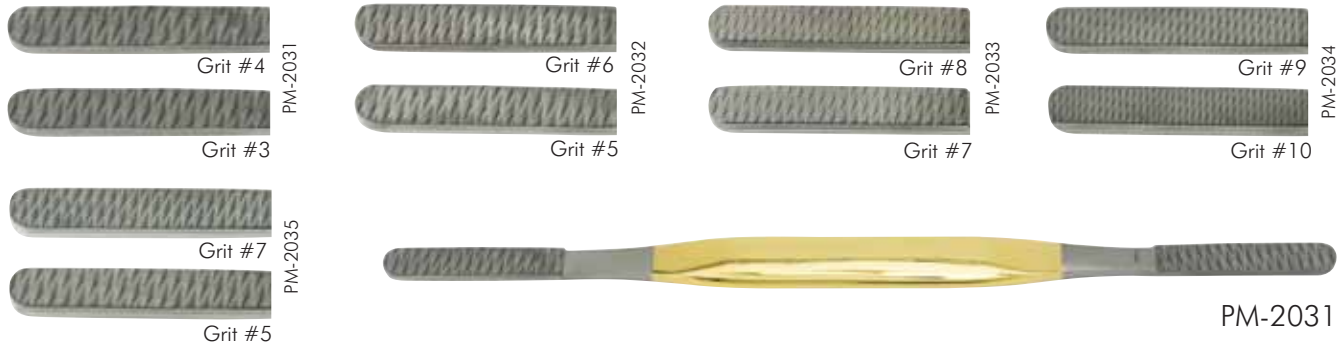

### McIndoe Nasal Rasp, Tungsten Carbide

Catalog#	Description	Length	Width
PM-1444TC	Straight, Forward Cutting	7" (178 mm)	7.5 mm



### Glabella Rasp, Tungsten Carbide

Catalog#	Description	Length	Width
PM-2105	Medium Grit, Reverse Cutting	8-1/4" (210 mm)	6 mm
21-394TC*	Medium Grit, Reverse Cutting	8-1/4" (210 mm)	6 mm

\*Miltex® Brand



### Maltz Nasal Rasp, Tungsten Carbide

Catalog#	Description	Length	Width
PM-1448TC	Straight, Reverse Cutting	7" (178 mm)	7.5 mm



PM-1448TC

### Parkes Rasp, Tungsten Carbide

Catalog#	Description	Length	Width
21-384TC*	Single-Ended Reverse Cutting, #1 Very Fine Grit	8-1/2" (216 mm)	7.5 mm
21-385TC*	Single-Ended Reverse Cutting, #2 Fine Grit	8-1/2" (216 mm)	7.5 mm
21-386TC*	Single-Ended Reverse Cutting, #3 Fine Grit	8-1/2" (216 mm)	7.5 mm
21-387TC*	Single-Ended Reverse Cutting, #4 Coarse Grit	8-1/2" (216 mm)	7.5 mm
21-388TC*	Single-Ended Reverse Cutting, #5 Coarse Grit	8-1/2" (216 mm)	7.5 mm
21-389TC*	Single-Ended Reverse Cutting, #6 Coarse Grit	8-1/2" (216 mm)	7.5 mm
21-390TC*	Single-Ended Reverse Cutting, #7 Coarse Grit	8-1/2" (216 mm)	7.5 mm
21-391TC*	Single-Ended Reverse Cutting, #8 Very Coarse Grit	8-1/2" (216 mm)	7.5 mm

\*Miltex® Brand

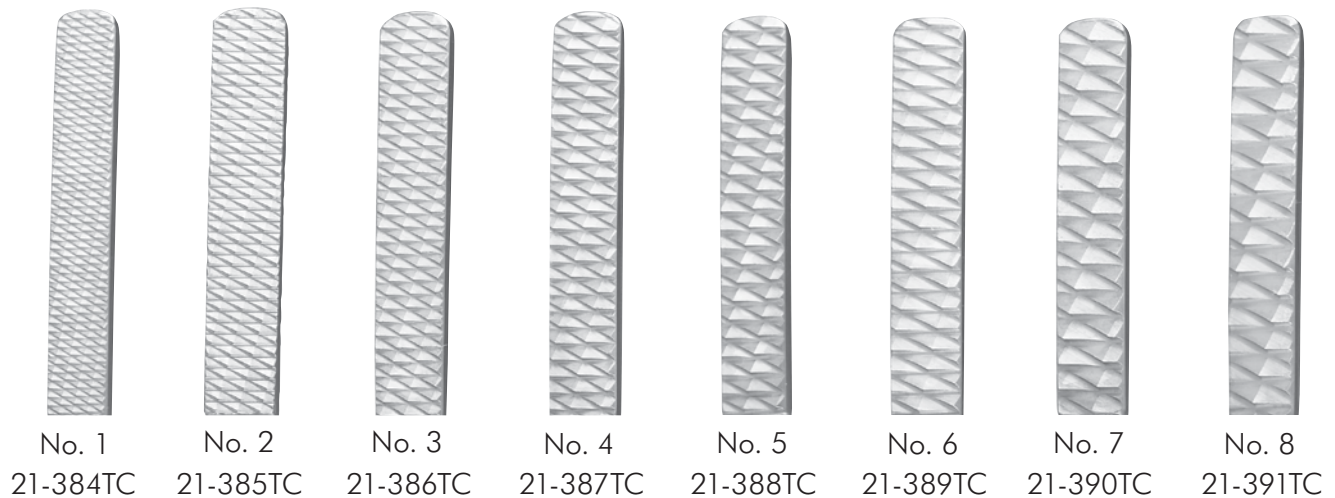

### Fomon Rasp, Double-Ended, Tungsten Carbide

Catalog#	Description	Length	Width
21-380TC*	Flat, Reverse Cutting, #1 Very Fine and #2 Fine Grit	8-1/4" (210 mm)	7.2 mm
21-381TC*	Flat, Reverse Cutting, #3 Fine and #4 Coarse Grit	8-1/4" (210 mm)	7.2 mm
21-382TC*	Flat, Reverse Cutting, #5 Coarse and #6 Coarse Grit	8-1/4" (210 mm)	7.2 mm
21-383TC*	Flat, Reverse Cutting, #7 Coarse and #8 Very Coarse Grit	8-1/4" (210 mm)	7.2 mm



\*Miltex® Brand

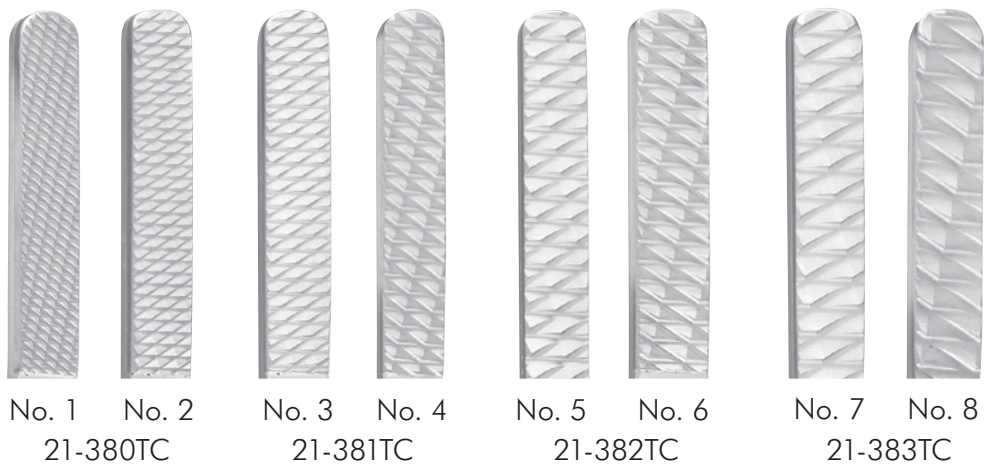

### Peet (Cottle) Finishing Rasp

Catalog#	Description	Length	Width
21-392DC*	Straight, Diamond Coated	7-1/2" (191 mm)	7.2 mm
21-393DC*	Curved, Diamond Coated	7-1/2" (191 mm)	7.2 mm

\*Miltex® Brand

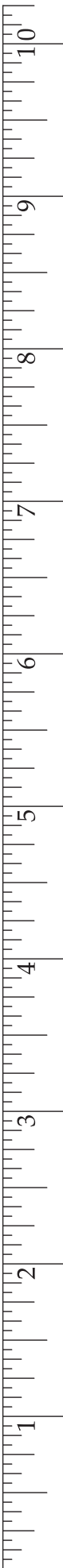



### Peet Nasal Rasp

Catalog#	Description	Length	Width
PM-1455	Convex, Straight, Diamond Coated	7-1/2" (191 mm)	7 mm
PM-1456	Flat, Straight, Diamond Coated	7-1/2" (191 mm)	7 mm
PM-1457	Convex, Curved, Diamond Coated	7-1/2" (191 mm)	7 mm
PM-1458	Flat, Curved, Diamond Coated	7-1/2" (191 mm)	7 mm
PM-1459	Concave, Straight, Diamond Coated	7-1/2" (191 mm)	7 mm



PM-1455

### Peet-Cottle Nasal Rasp

Catalog#	Description	Length	Width
PM-7411	Flat, Straight, Diamond Coated	8" (203 mm)	9 mm



PM-7411

### Peet-Aufricht Glabellar Rasp

Catalog#	Description	Length	Width
PM-7422	Flat, Curved, Diamond Coated	8" (203 mm)	8.3 mm

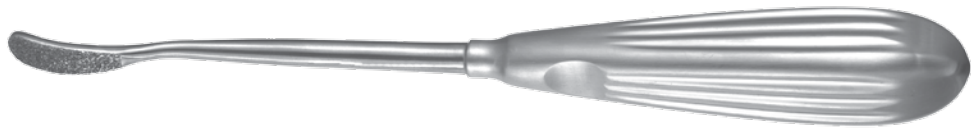

PM-7422

### Cottle Nasal Rasp

Catalog#	Description	Length	Width
21-338*	Reverse Cutting	8" (203 mm)	8.5 mm



\*Miltex® Brand

21-338





### Aufricht Glabellar Rasp

Catalog#	Description	Length	Width
21-346*	Curved, Forward Cutting	7-1/8" (181 mm)	8 mm
21-348*	Curved, Reverse Cutting	7-1/8" (181 mm)	8 mm

\*Miltex® Brand



21-346

### Barsky Nasal Rasp

Catalog#	Description	Length	Width
PM-1440	Straight, Reverse Cutting, Concave	6-1/2" (165 mm)	8.2 mm



PM-1440

### Barsky Glabellar Rasp

Catalog#	Description	Length	Width
PM-1442	Curved, Reverse Cutting	7" (178 mm)	6.5 mm



PM-1442

### McIndoe Nasal Rasp

Catalog#	Description	Length	Width
PM-1444	Straight, Reverse Cutting	6-1/2" (165 mm)	8.0 mm



PM-1444

### Joseph Nasal Rasp

Catalog#	Description	Length	Width
PM-4395	Forward and Reverse Cutting, #1 Fine Teeth	6-1/4" (159 mm)	9 mm
PM-4396	Forward and Reverse Cutting, #2 Medium Teeth	6-1/4" (159 mm)	9 mm



PM-4395

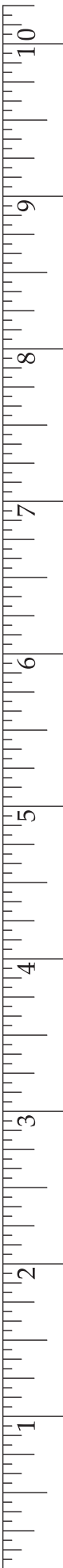

### Maltz Double-Sided Rasp

Catalog#	Description	Length	Width
PM-1445	Forward and Reverse Cutting	7" (178 mm)	7.5 mm



PM-1445

### Maltz Nasal Rasp

Catalog#	Description	Length	Width
21-342*	Straight, Reverse Cutting	7" (178 mm)	8.2 mm
PM-1448	Straight, Reverse Cutting	7" (178 mm)	7.5 mm
PM-1450	Curved, Forward Cutting with Deep Serrations	7-1/4" (184 mm)	6.5 mm
PM-1452	Straight, Forward Cutting with Deep Serrations	7-1/4" (184 mm)	6.5 mm



PM-1450



PM-1448

\*Miltex® Brand

### Maltz Rasp, Double-Ended

Catalog#	Description	Length	Width
21-343*	Improved Pattern, Forward and Reverse Cutting	8-1/4" (210 mm)	8 mm



\*Miltex® Brand

21-343

### Fomon Rasp, Double-Ended

Catalog#	Description	Length	Width
PM-4880	Fine Teeth, Flat and Convex, Reverse Cutting	8-1/2" (216 mm)	7.5 mm
PM-4881	Coarse Teeth, Flat and Convex, Reverse Cutting	8-1/2" (216 mm)	7.5 mm



PM-4880

### Fomon-Type Nasal Rasp, Double-Ended

Catalog#	Description	Length	Width
21-368*	4-Sided, Fine & Coarse Teeth, both Ends Flat & Convex Reverse Cutting	8-1/4" (210 mm)	8.5 mm
21-369*	Coarse Teeth, Flat and Convex, Reverse Cutting	8-1/4" (210 mm)	7 mm
21-370*	Fine Teeth, Flat and Convex, Reverse Cutting	8-1/4" (210 mm)	7 mm

\*Miltex® Brand



21-369

### Parkes Rasp

Catalog#	Description	Length	Width
PM-4877	Fine, Reverse Cutting	8" (203 mm)	8.9 mm
PM-4878	Coarse, Reverse Cutting	8" (203 mm)	8.9 mm



PM-4877

### Reidy Nasal Rasp

Catalog#	Description	Length	Width
PM-1454	Curved, Cross Serrated, Forward and Reverse Cutting	9" (229 mm)	10 mm



PM-1454

### Lamont Nasal Rasp

Catalog#	Description	Length	Width
PM-7426	Straight, Reverse Cutting, Convex	7" (178 mm)	6.5 mm



PM-7426

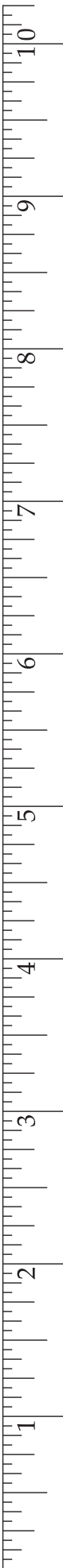

### Lewis Nasal Rasp

Catalog#	Description	Length	Width
21-352*	Fine Teeth, Reverse Cutting	7-1/2" (191 mm)	7 mm
21-354*	Coarse Teeth, Reverse Cutting	7-1/2" (191 mm)	7 mm

\*Miltex® Brand



21-352

### Converse Rasp, Double-Ended

Catalog#	Description	Length	Width
PM-4879	Fine and Coarse Ends, Reverse Cutting	7" (178 mm)	11 mm



PM-4879

### Cleft Palate Rasp

Catalog#	Description	Length	Width
PM-1284L	Curved Upwards, Left	5-1/2" (140 mm)	5 mm
PM-1284R	Curved Upwards, Right	5-1/2" (140 mm)	5 mm

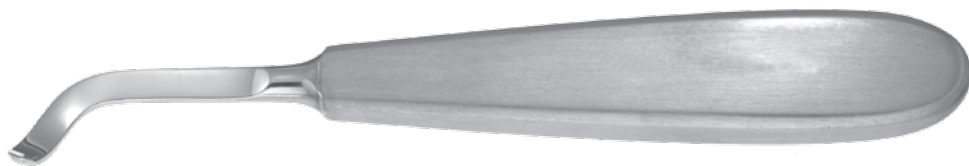

PM-1284L

### Cleft Palate Rasp

Catalog#	Description	Length	Width
PM-1292D	Curved Downward	5-1/2" (140 mm)	5 mm
PM-1292U	Curved Upward	5-1/2" (140 mm)	5 mm



PM-1292D

### Barsky Cleft Palate Rasp

Catalog#	Description	Length	Width
PM-1296	Double-Ended	8-1/4" (210 mm)	4 mm



### McIndoe Cleft Palate Rasp

PM-1296

Catalog#	Description	Length
PM-1306L	Double-Ended Large	6-1/2" (165 mm)
PM-1306M	Double-Ended Medium	6-1/2" (165 mm)
PM-1306S	Double-Ended Small	6-1/4" (159 mm)



PM-1306L

### Padgett French Pattern Cleft Palate Rasp

Catalog#	Description	Length	Blade
PM-7771	Right	7-1/2" (191 mm)	4 mm x 11 mm
PM-7770	Left	7-1/2" (191 mm)	4 mm x 11 mm



PM-7771

### Wire Brush to Clean Rasps

Catalog#	Description	Length
21-379*	Stainless Steel, Autoclavable	6-1/4" (159 mm)
3-1001*	Stainless Steel, Autoclavable, Set of 3	7-1/4" (184 mm)

\*Miltex® Brand



21-379



3-1001

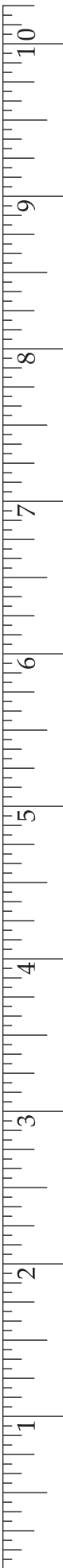

### Miller Bone File, Double-Ended

Miller Bone File patterns are ideal for removing mandibular/maxillary ridges after tooth extraction.

Catalog#	Description	Length	Width 1	Width 2
PM-4411	Small and Medium, Reverse Cutting	7-1/4" (184 mm)	5.0 mm	4.2 mm



PM-4411

### Miller-Colburn File, Double-Ended

Catalog#	Description	Length
PM-4554	Medium and Large, Reverse Cutting	7-1/4" (184 mm)



PM-4554

### Miller Bone File, Double-Ended

Catalog#	Description	Length	Width 1	Width 2
PM-4409	Large and Small, Reverse Cutting	7" (178 mm)	4.8 mm	5.3 mm



PM-4409

### Miller Bone File, Double-Ended

Catalog#	Description	Length	Width 1	Width 2
PM-4410	Small and Extra Small, Reverse Cutting	7" (178 mm)	6.3 mm	5.3 mm

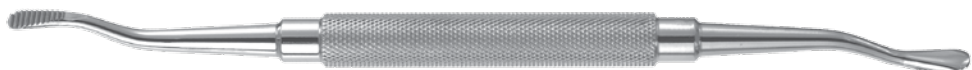

PM-4410

### Bone Files, Reverse Cutting, Double-Ended

Catalog#	Description	Length
40-1370*	No. 10 pattern, standard serrations	7" (178 mm)
40-1371*	No. 33 pattern, standard serrations	7" (178 mm)
40-1375*	No. 64 pattern, standard serrations	7" (178 mm)
40-1380*	No. 45 pattern, standard serrations	7" (178 mm)
40-1381*	No. 12 pattern, standard serrations	7" (178 mm)
40-1382*	No. 12A pattern, standard and cross serrations	7" (178 mm)
40-1385*	No. 12CA BELL pattern, cross serrations	7" (178 mm)
40-2800*	POLOKOFF narrow pattern, standard serrations	7-1/4" (184 mm)



40-1370

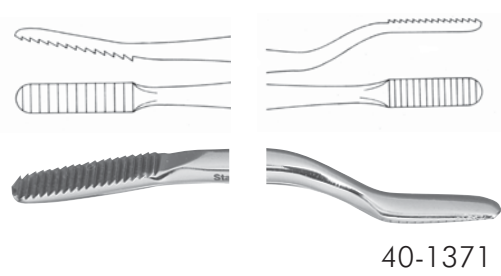

40-1371

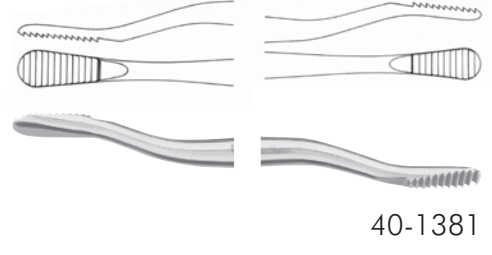

40-1381

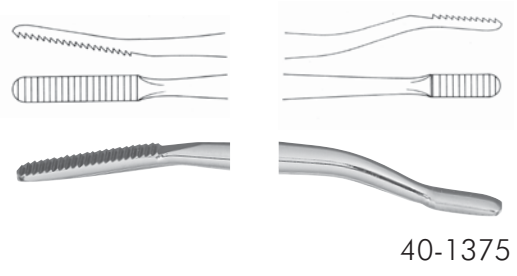

40-1375

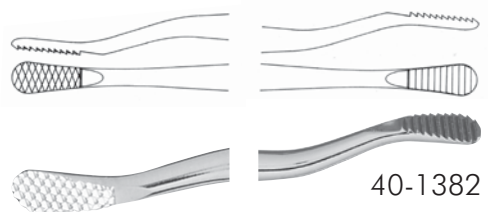

40-1382

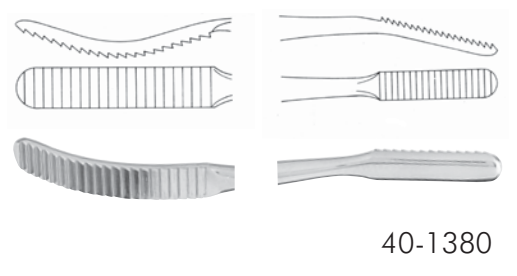

40-1380

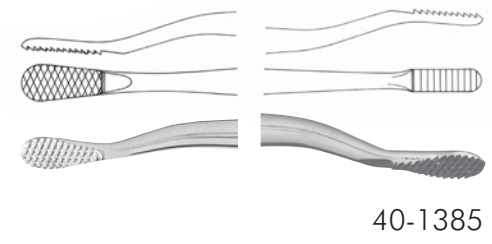

40-1385

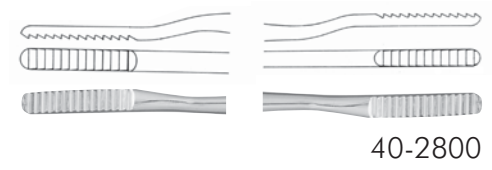

40-2800

\*Miltex® Brand

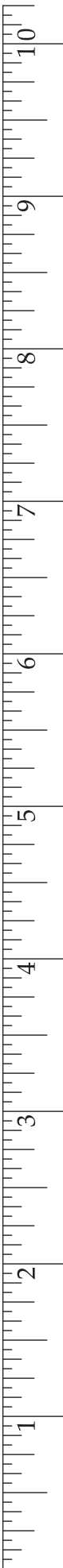



### Joseph Bayonet Nasal Saw

Catalog#	Description	Length	Blade
21-282*	Right, with Thumb Rest	7-1/2" (191 mm)	37 mm
21-284*	Left, with Thumb Rest	7-1/2" (191 mm)	37 mm

\*Miltex® Brand



21-282

### Joseph Saw

Catalog#	Description	Length	Blade
21-280*	Straight, with Thumb Rest	7-1/2" (191 mm)	38 mm

\*Miltex® Brand



21-280

### Joseph-Maltz Nasal Saw

Catalog#	Description	Length
21-288*	Angled Right	4" (102 mm)
21-290*	Angled Left	4" (102 mm)

\*Miltex® Brand



21-288



## Gigli Saw Handle

Catalog#	Description	Length
26-119*	T-Shaped, Turnable	2-1/2" (64 mm)
26-120*	T-Shaped, Rigid with Snap-Lock	2-1/2" (64 mm)
26-122*	T-Shaped, Turnable with Snap-Lock	2-1/2" (64 mm)

\*Miltex® Brand

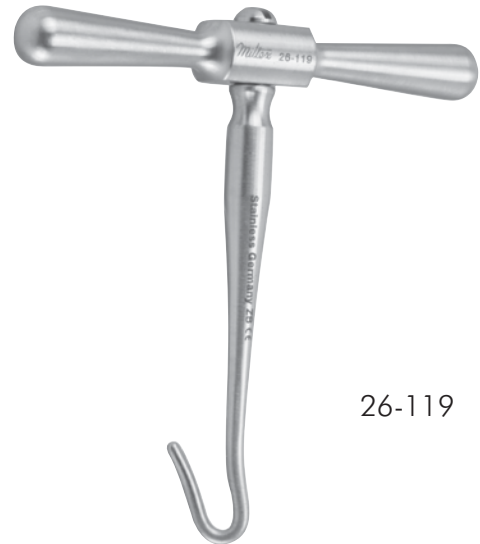

26-119

## Gigli Saw

Catalog#	Description	Length
26-130*	Standard Twisted Wire Type	12" (305 mm)
26-132*	Standard Twisted Wire Type	20" (508 mm)

\*Miltex® Brand

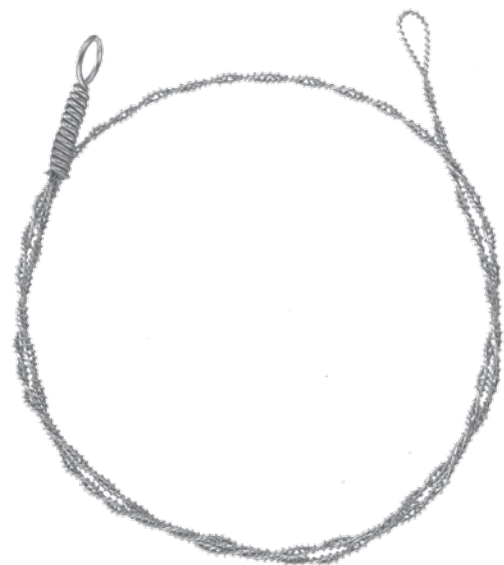

26-130

# SCISSORS



Ceramic  
SuperCut  
Tungsten Carbide  
Standard

## SUPERCUT SCISSORS

SuperCut Scissors have a specially designed razor-sharp upper blade edge that cuts effortlessly through tissue. The lower blade has micro-fine serrations to hold tissue and prevent slippage. For easy identification, Miltex & Padgett SuperCut Scissors have two black ring handles.

*SuperCut scissors are designed to cut tissue only. Dropping or mishandling will cause the razor-sharp edge to nick or become irregular. Proper handling will ensure lifetime service. Resharpenering at regular intervals is recommended and is a service that Miltex provides.*

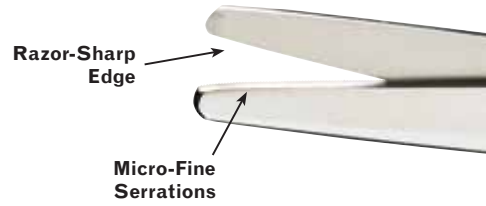

## TUNGSTEN CARBIDE SCISSORS\*

Scissors with Tungsten Carbide inserts seamlessly bonded to the upper and lower blades. These premium-grade scissors offer precision cutting performance as well as the durability of Tungsten Carbide cutting edges.

Tungsten Carbide Scissors represent a considerable cost savings to the clinician as a result of consistently superior performance and extended service life.

Miltex & Padgett Tungsten Carbide Scissors are easily identified by their gold ring handles.

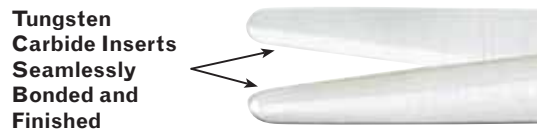

## SUPERCUT/TUNGSTEN CARBIDE SCISSORS\*

The combination SuperCut/Tungsten Carbide Scissors offer precision SuperCut performance with one lower serrated blade and one upper razor-sharp blade combined with the durability of Tungsten Carbide cutting edges.

Miltex SuperCut/Tungsten Carbide Scissors are easily identified with one short and one long gold-plated ring handle and Padgett scissors have two long gold plated ring handles.

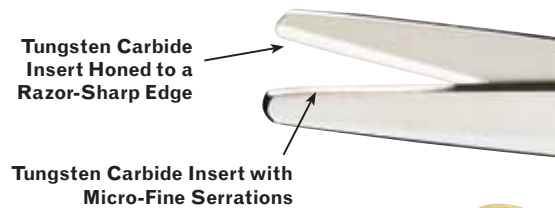

\* Note: cold or chemical sterilization is not recommended for Tungsten Carbide instruments.

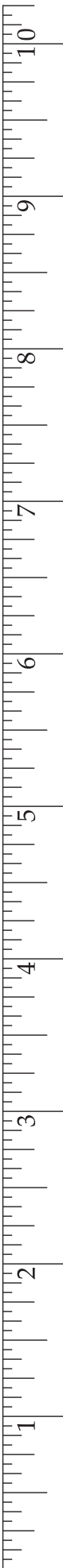

## ANATOMY OF MILTEX® & PADGETT® SCISSORS

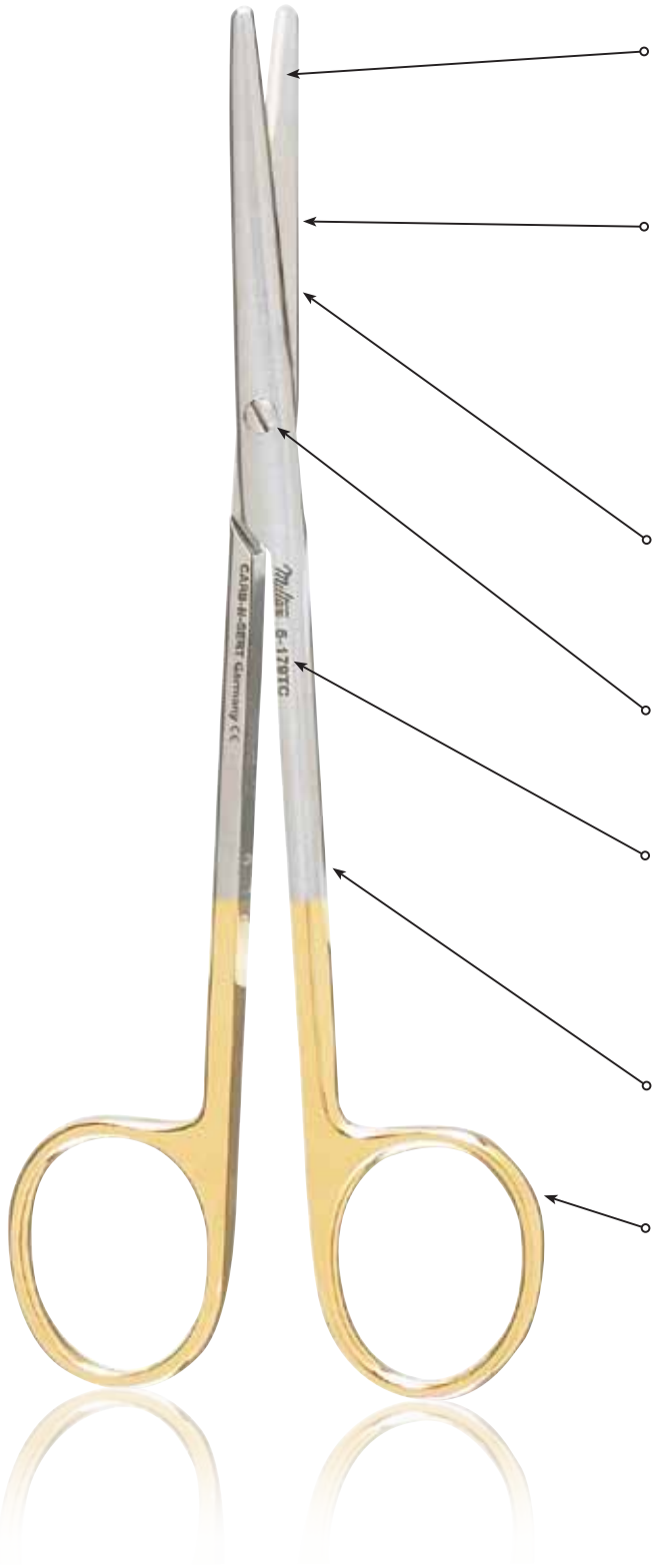

**CHOICE OF BLADES**

Tungsten Carbide  
SuperCut  
SuperCut/Tungsten Carbide combination

**BLADE DESIGN**

Tungsten Carbide inserts are seamlessly bonded to the finest quality stainless steel surgical scissors and then precisely ground and honed on diamond wheels.

SuperCut scissors have a finely beveled blade with a razor-sharp edge and opposing blade with micro-fine serrations to prevent tissue slippage and facilitate effortless cutting.

**STRENGTH & HARDNESS**

Manufactured to ensure greater Rockwell hardness for instrument durability and longer-lasting blade edge sharpness.

**SCREW LOCK**

Fully tempered precision screw locks maintain perfect alignment.

**LASER ETCHING**

All Miltex and Padgett scissors are laser etched with our logo and catalog number for easy re-ordering. Advanced laser techniques are used and will not harm or damage the instrument as did older and traditional acid etching techniques.

**ERGONOMIC DESIGN**

Outstanding instrument design combines weight, balance and feel for optimal comfort and performance.

**RING HANDLES**

Well rounded and polished for better "feel and comfort" as well as prevention of hand fatigue. Gold and black finished handles differentiate Tungsten Carbide and SuperCuts as precision instruments.

# CERAMIC SCISSORS

These scissors offer an innovative design that includes Ceramic and Tungsten Carbide materials for maximizing surface hardness and durability combined with our SuperCut blade design for superior cutting performance.

This threefold design enables the blade to maintain its sharpness 81% longer than standard stainless steel scissors. The combination of Ceramic Coating and Tungsten Carbide creates a stronger and more resistant surface that protects against wear and tear and increases cutting edge longevity.

These scissors also feature SuperCut blades designed to cut tissue effortlessly by combining a razor-sharp edge blade with a lower micro-fine serrated blade. This combination holds tissue and prevents slippage.

## Ceramic Coating

- Black “anti-glare” surface avoids reflection.
- Ceramic Coating and Micro-smooth surface of the instrument significantly reduces friction, abrasion and lessens wear and tear to the instrument.
- Physical and chemical bonding of the instrument coating provides a resistant barrier to chemical and biological contaminants.
- Ceramics are biocompatible and non-allergenic.



*Ceramic Coating offers 82 HRC hardness, which is 4-6 times higher than regular TC scissors.*

*Tungsten Carbide Inserts are Seamlessly Bonded and Finished*



## Tungsten Carbide

- The combination of Ceramic and Tungsten Carbide offers a considerable cost savings to the clinician through extended service life of the instrument

*Razor-Sharp Edge*

*Micro-Fine Serrations*

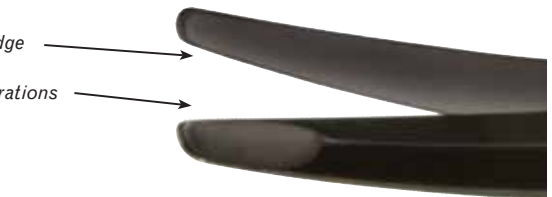

## SuperCut

- A critical feature for cutting tissue

*Ceramic Coating increases sharpness longevity for the lifetime of the cutting edge.*

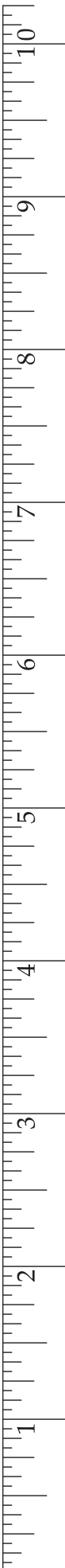
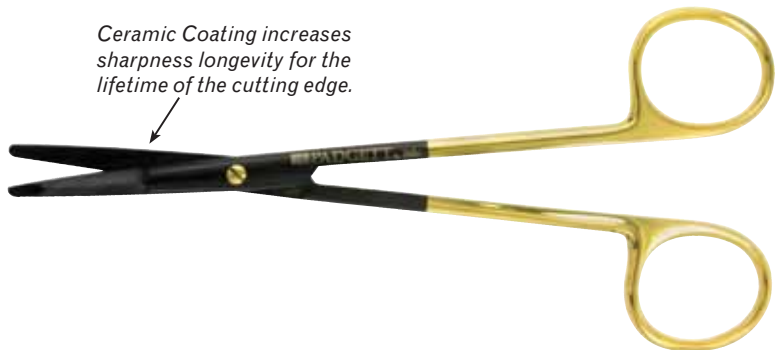

## ANATOMY OF CERAMIC SCISSORS



### **CERAMIC COATING**

The Ceramic Coating on the blades offers a smooth surface for minimized friction, increases sharpness longevity and extends the lifetime of the cutting edge.

### **BLADE DESIGN**

These scissors include Ceramic Coating, Tungsten Carbide materials and SuperCut blade features combined into one superior instrument. This combination optimizes precision cutting performance

### **SCREW LOCK**

Fully tempered precision gold-plated screw lock maintains perfect alignment.

### **LASER ETCHING**

All Padgett by Miltex® scissors are laser etched with our logo and catalog number for easy re-ordering. Advanced laser techniques are used that will not harm or damage the instrument.

### **DESIGN**

Outstanding instrument design combines weight, balance and feel for optimal comfort and performance.

### **RING HANDLES**

Well rounded and polished for better “feel and comfort”, as well as for the prevention of hand fatigue. Our Ceramic Coated Scissors have attractive gold-plated ring handles that identify the blades as Tungsten Carbide.

### Mayo Dissecting Scissors, Standard Beveled Blades (CC/SC/TC)

Catalog#	Description	Length
----------	-------------	--------

PM-5SC124CTC	Straight	6-3/4" (171 mm)
--------------	----------	-----------------



PM-5SC124CTC

### Metzenbaum Dissecting Scissors (CC/SC/TC)

Catalog#	Description	Length
----------	-------------	--------

PM-5SC180CTC	Curved	5-1/2" (140 mm)
--------------	--------	-----------------

PM-5SC182CTC	Curved	7" (178 mm)
--------------	--------	-------------



PM-5SC180CTC

### Iris Scissors (CC/SC/TC)

Catalog#	Description	Length
----------	-------------	--------

PM-5SC304CTC	Straight	4-1/2" (114 mm)
--------------	----------	-----------------

PM-5SC306CTC	Curved	4-1/2" (114 mm)
--------------	--------	-----------------



PM-5SC304CTC

### Strabismus Scissors (CC/SC/TC)

Catalog#	Description	Length
----------	-------------	--------

PM-5SC314CTC	Curved	4-1/2" (114 mm)
--------------	--------	-----------------



PM-5SC314CTC

### Kaye Face Lift Scissors (CC/SC/TC)

Kaye and Kaye-Freeman scissors have saber-back blades and semi-sharp outer edges for effortlessly passing through and undermining tissue.

Catalog#	Description	Length
PM-21SC740CTC	Curved, Blunt Flat Tips, Saber-Back Blades	5-3/4" (146 mm)



PM-21SC740CTC

### Kaye-Freeman Scissors (CC/SC/TC)

Catalog#	Description	Length
PM-21SC710CTC	Curved, Blunt Flat Tips, Saber-Back Blades	7" (178 mm)
PM-21SC711CTC	Straight, Blunt Flat Tips, Saber-Back Blades	7" (178 mm)



PM-21SC710CTC



### Gorney-Freeman Scissors (CC/SC/TC)

Gorney-Freeman and Gorney Scissors have saber-back blades and semi-sharp outer edges for effortlessly passing through and undermining tissue.

Catalog#	Description	Length
PM-21SC715CTC	Curved, Blunt Flat Tips, Saber-Back Blades	7-1/4" (184 mm)
PM-21SC716CTC	Straight, Blunt Flat Tips, Saber-Back Blades	7-1/4" (184 mm)



PM-21SC716CTC

### Gorney Scissors (CC/SC/TC)

Catalog#	Description	Length
PM-21SC607CTC	Straight, Blunt Flat Tips, Saber-Back Blades	7-1/2" (191 mm)
PM-21SC608CTC	Curved, Blunt Flat Tips, Saber-Back Blades	7-1/2" (191 mm)



PM-21SC607CTC

### Fomon Dorsal Scissors (SC/TC)

Catalog#	Description	Length
----------	-------------	--------

PM-6851TC	Angled	5-1/4" (133 mm)
-----------	--------	-----------------



PM-6851TC

### Cottle Dorsal Scissors (SC/TC)

This pattern is a heavier version than PM-6852.

Catalog#	Description	Length
----------	-------------	--------

PM-6852TC	Angled	6-1/4" (159 mm)
-----------	--------	-----------------



PM-6852TC

### Par Tissue Scissors (SC/TC)

Catalog#	Description	Length
----------	-------------	--------

PM-6855TC	Curved, Delicate	4-1/2" (114 mm)
PM-6856TC	Curved, Delicate	5-1/2" (140 mm)

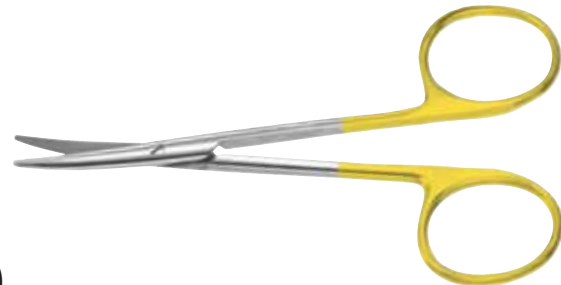

PM-6855TC

### Wilkinson Rhytidectomy Scissors (SC/TC)

Catalog#	Description	Length
----------	-------------	--------

PM-6873TC	Double Curve, Saber-Back Blades	7-1/2" (191 mm)
-----------	---------------------------------	-----------------

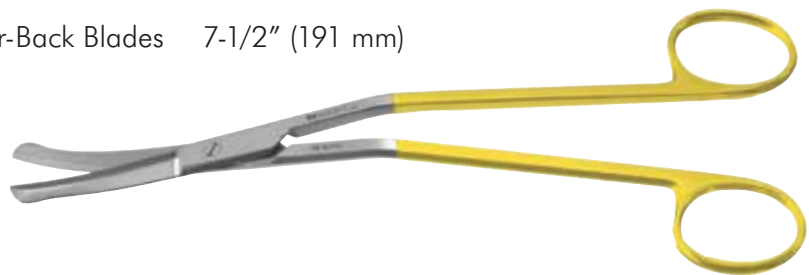

PM-6873TC

### Stevens Tenotomy Scissors (SC/TC)

Catalog#	Description	Length
----------	-------------	--------

PM-6860TC	Curved, Blunt	4-1/2" (114 mm)
-----------	---------------	-----------------



PM-6860TC



### Kaye Rhytidectomy Scissors (SC/TC)

Catalog#	Description	Length
PM-6840TC	Curved, Saber-Back Blades	5-3/4" (146 mm)
PM-6841TC	Curved, Saber-Back Blades	7-1/2" (191 mm)



PM-6840TC

### Freeman-Kaye Rhytidectomy Scissors (SC/TC)

Catalog#	Description	Length
PM-6843TC	Curved, Saber-Back Blades	7" (178 mm)



PM-6843TC

### Reynolds Scissors (SC/TC)

Catalog#	Description	Length
PM-6845TC	Curved, Semi-Sharp	5" (127 mm)



PM-6845TC

### Jamison Scissors (SC/TC)

Catalog#	Description	Length
PM-6847TC	Curved, Semi-Sharp	5-1/2" (140 mm)



PM-6847TC



**Gorney Rhytidectomy Scissors (SC/TC)**

Catalog#	Description	Length
PM-6830TC	Straight, Saber-Back Blades	7-1/4" (184 mm)
PM-6831TC	Curved, Saber-Back Blades	7-1/4" (184 mm)



PM-6830TC

**Gorney Platysma Scissors (SC/TC)**

Catalog#	Description	Length
PM-6832TC	Straight, Saber-Back Blades	9" (229 mm)
PM-6833TC	Curved, Saber-Back Blades	9" (229 mm)



PM-6832TC

**Freeman-Gorney Rhytidectomy Scissors (SC/TC)**

Catalog#	Description	Length
PM-6834TC	Straight, Saber-Back Blades	7-1/4" (184 mm)
PM-6835TC	Curved, Saber-Back Blades	7-1/4" (184 mm)



PM-6834TC

**Freeman Rhytidectomy Scissors (SC/TC)**

Catalog#	Description	Length
PM-6836TC	Curved	7" (178 mm)

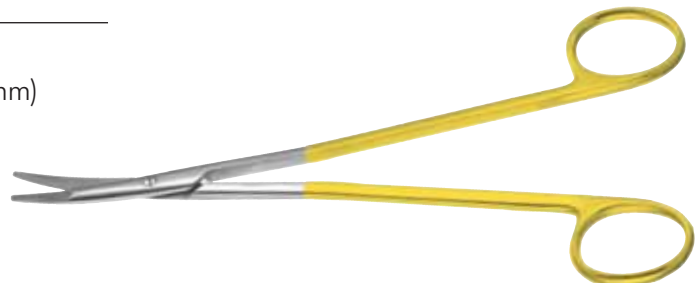

PM-6836TC



### Metzenbaum Dissecting Scissors (SC/TC)

Catalog#	Description	Length
PM-6810TC	Curved	5-3/4" (146 mm)
PM-6811TC	Curved	7" (178 mm)
5-SC-182TC*	Curved	7" (178 mm)
PM-6812TC	Curved	9" (229 mm)
PM-6813TC	Curved, Delicate	7" (178 mm)

\*Miltex® Brand



PM-6810TC

### Iris Tissue Scissors (SC/TC)

Catalog#	Description	Length
PM-6815TC	Straight, Sharp	4-1/2" (114 mm)
PM-6816TC	Curved, Sharp	4-1/2" (114 mm)
5-SC-304TC*	Straight, Sharp	4-1/2" (114 mm)
5-SC-306TC*	Curved, Sharp	4-1/2" (114 mm)

\*Miltex® Brand



PM-6815TC

### Padgett Nasal and Dissecting Scissors (SC/TC)

Catalog#	Description	Length
PM-6821TC	Curved, Sharp	4-3/4" (121 mm)



PM-6821TC

### Joseph Scissors (SC/TC)

Catalog#	Description	Length
PM-6822TC	Curved, Sharp	5-1/2" (140 mm)



PM-6822TC

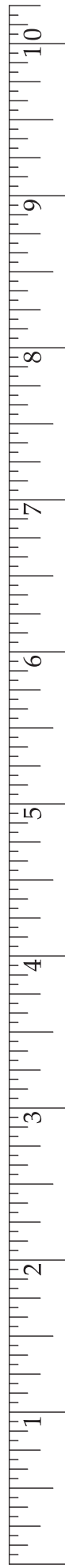



### Mayo Dissecting Scissors (SC)

Catalog#	Description	Length
PM-6800	Straight	5-1/2" (140 mm)
5-SC-120*	Straight	5-1/2" (140 mm)
PM-6805	Straight	6-3/4" (171 mm)
5-SC-124*	Straight	6-3/4" (171 mm)
5-SC-128*	Straight	9" (229 mm)
PM-6801	Curved	5-1/2" (140 mm)
5-SC-122*	Curved	5-1/2" (140 mm)
PM-6806	Curved	6-3/4" (171 mm)
5-SC-126*	Curved	6-3/4" (171 mm)
5-SC-130*	Curved	9" (229 mm)



PM-6800

\*Miltex® Brand

### Metzenbaum Dissecting Scissors (SC)

Catalog#	Description	Length
5-SC-283*	Straight	4-1/2" (114 mm)
5-SC-179*	Straight	5-1/2" (140 mm)
5-SC-284*	Curved	4-1/2" (114 mm)
5-SC-180*	Curved	5-1/2" (140 mm)
PM-6810	Curved	5-3/4" (146 mm)
PM-6811	Curved	7" (178 mm)
5-SC-182*	Curved	7" (178 mm)
PM-6813	Curved, Delicate	7" (178 mm)
PM-6812	Curved	9" (229 mm)
5-SC-188*	Curved	9" (229 mm)



PM-6810

\*Miltex® Brand

### Iris Tissue Scissors (SC)

Catalog#	Description	Length
PM-6815	Straight, Sharp	4-1/2" (114 mm)
PM-6816	Curved, Sharp	4-1/2" (114 mm)
5-SC-304*	Straight, Sharp	4-1/2" (114 mm)
5-SC-306*	Curved, Sharp	4-1/2" (114 mm)



PM-6815

\*Miltex® Brand

### Operating Scissors (SC)

Catalog#	Description	Length
5-SC-16*	Straight, Sharp/Blunt	5-1/2" (140 mm)
5-SC-46*	Curved, Sharp/Blunt	5-1/2" (140 mm)



5-SC-16

\*Miltex® Brand

### Gradle Scissors (SC)

Catalog#	Description	Length
PM-6818	Ribbon Rings, Slightly Curved, Sharp	4" (102 mm)
18-SC-1652*	Standard Rings, Slightly Curved, Blunt	3-3/4" (95 mm)

\*Miltex® Brand

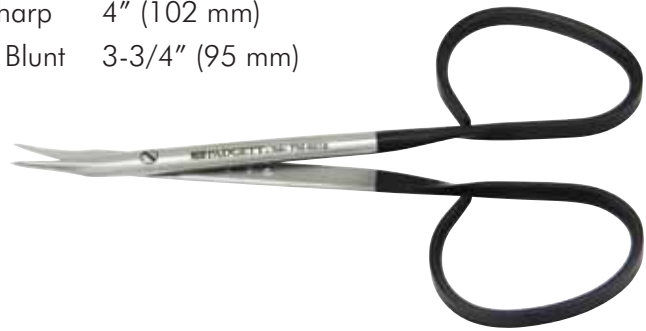

PM-6818

### Nasal and Dissecting Scissors (SC)

Catalog#	Description	Length
PM-6820	Straight, Sharp	4-3/4" (121 mm)
PM-6821	Curved, Sharp	4-3/4" (121 mm)
5-SC-270*	Straight, Sharp	4-3/4" (121 mm)
5-SC-276*	Curved, Sharp	4-3/4" (121 mm)

\*Miltex® Brand



PM-6820

### Castanares Rhytidectomy Scissors (SC)

Catalog#	Description	Length
PM-6825	Straight	6-1/4" (159 mm)



PM-6825

### Gorney Rhytidectomy Scissors (SC)

Catalog#	Description	Length
PM-6830	Straight, Saber-Back Blades	7-1/4" (184 mm)
PM-6831	Curved, Saber-Back Blades	7-1/4" (184 mm)
21-SC-607*	Straight, Saber-Back Blades	7-1/2" (191 mm)
21-SC-608*	Curved, Saber-Back Blades	7-1/2" (191 mm)

\*Miltex® Brand



PM-6830

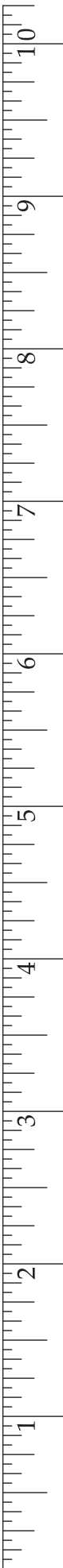

**Gorney Platysma Scissors (SC)**

Catalog#	Description	Length
PM-6832	Straight, Saber-Back Blades	9" (229 mm)
PM-6833	Curved, Saber-Back Blades	9" (229 mm)



PM-6832

**Freeman-Gorney Rhytidectomy Scissors (SC)**

Catalog#	Description	Length
PM-6834	Straight, Saber-Back Blades	7-1/4" (184 mm)
PM-6835	Curved, Saber-Back Blades	7-1/4" (184 mm)
21-SC-716*	Straight, Saber-Back Blades	7-1/4" (184 mm)
21-SC-715*	Curved, Saber-Back Blades	7-1/4" (184 mm)

\*Miltex® Brand



PM-6834

**Freeman Rhytidectomy Scissors (SC)**

Catalog#	Description	Length
PM-6836	Curved	7" (178 mm)



PM-6836

**Kaye Rhytidectomy Scissors (SC)**

Catalog#	Description	Length
PM-6840	Curved, Saber-Back Blades	5-1/2" (140 mm)
PM-6841	Curved, Saber-Back Blades	7-1/2" (191 mm)



PM-6840

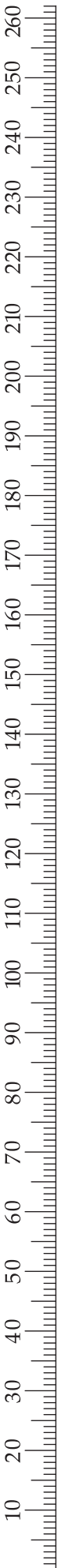



### Freeman-Kaye Rhytidectomy Scissors (SC)

Catalog#	Description	Length
PM-6842	Straight, Saber-Back Blades	7" (178 mm)
PM-6843	Curved, Saber-Back Blades	7" (178 mm)
21-SC-711*	Straight, Saber-Back Blades	7" (178 mm)
21-SC-710*	Curved, Saber-Back Blades	7" (178 mm)

\*Miltex® Brand



PM-6842

### Joseph Scissors (SC)

Catalog#	Description	Length
PM-6822	Curved, Sharp	5-1/2" (140 mm)



PM-6822

### Reynolds Scissors (SC)

Catalog#	Description	Length
PM-6845	Curved, Semi-Sharp	5" (127 mm)



PM-6845

### Jamison Scissors (SC)

Catalog#	Description	Length
PM-6847	Curved, Semi-Sharp	5-1/2" (140 mm)
PM-6848	Curved, Semi-Sharp	7" (178 mm)



PM-6847

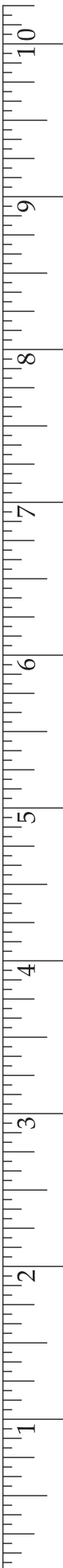

**Fomon Lateral Scissors (SC)**

Catalog#	Description	Length
----------	-------------	--------

PM-6850	Curved	4-1/2" (114 mm)
---------	--------	-----------------



PM-6850

**Fomon Dorsal Scissors (SC)**

Catalog#	Description	Length
----------	-------------	--------

PM-6851	Angled	5-1/2" (140 mm)
---------	--------	-----------------



PM-6851

**Fomon Saber-Back Scissors (SC)**

Catalog#	Description	Length
----------	-------------	--------

21-SC-600*	Slightly Curved Blades with Semi-Sharp Outer Edges for Dissection	5-1/4" (133 mm)
------------	---	-----------------

\*Miltex® Brand



21-SC-600

**Cottle Dorsal Scissors (SC)**

This pattern is a lighter version than PM-6852TC.

Catalog#	Description	Length
----------	-------------	--------

PM-6852	Angled	6-1/8" (156 mm)
---------	--------	-----------------



PM-6852

**Par Tissue Scissors (SC)**

Catalog#	Description	Length
----------	-------------	--------

PM-6855	Curved, Delicate	4-1/2" (114 mm)
21-SC-745*	Curved, Delicate	4-1/2" (114 mm)
PM-6856	Curved, Delicate	5-3/4" (146 mm)

\*Miltex® Brand



PM-6855



### Stevens Tenotomy Scissors (SC)

Catalog#	Description	Length
18-SC-1470*	Straight, Sharp	4-1/2" (114 mm)
18-SC-1472*	Straight, Blunt	4-1/2" (114 mm)
18-SC-1474*	Curved, Sharp	4-1/2" (114 mm)
18-SC-1476*	Curved, Blunt	4-1/2" (114 mm)
PM-6860	Curved, Semi-Sharp	4-1/2" (114 mm)

\*Miltex® Brand



18-SC-1470

### Jabaley Scissors, Off-Set Handles (SC)

Catalog#	Description	Length
PM-6862	Curved, Semi-Sharp	4-1/2" (114 mm)
PM-6863	Straight, Semi-Sharp	4-1/2" (114 mm)



PM-6863

### Goldman-Fox Scissors (SC)

Catalog#	Description	Length
5-SC-320*	Curved, Blunt	5" (127 mm)

\*Miltex® Brand



5-SC-320

### Ragnell (Kilner) Scissors (SC)

Catalog#	Description	Length
5-SC-290*	Curved, Blunt	5" (127 mm)

\*Miltex® Brand



5-SC-290

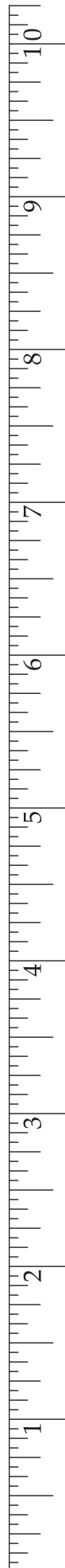

**Operating Scissors (TC)**

Catalog#	Description	Length
5-16TC*	Straight, Sharp/Blunt	5-1/2" (140 mm)
5-26TC*	Straight, Blunt/Blunt	5-1/2" (140 mm)
PM-2620	Straight, Sharp/Sharp	5-1/2" (140 mm)
5-6TC*	Straight, Sharp/Sharp	5-1/2" (140 mm)
5-36TC*	Curved, Sharp/Sharp	5-1/2" (140 mm)
5-46TC*	Curved, Sharp/Blunt	5-1/2" (140 mm)
PM-2610	Curved, Sharp/Blunt	5-1/2" (140 mm)
5-56TC*	Curved, Blunt/Blunt	5-1/2" (140 mm)
PM-2630	Curved, Sharp/Sharp	5-1/2" (140 mm)



Sharp/Sharp



Sharp/Blunt



Blunt/Blunt

\*Miltex® Brand



PM-2620

**Padgett Strabismus Scissors (TC)**

Catalog#	Description	Length
PM-2700	Curved	4-1/2" (114 mm)
PM-2701	Straight	4-1/2" (114 mm)
5-314TC*	Curved	4-1/2" (114 mm)
5-312TC*	Straight	4-1/2" (114 mm)

\*Miltex® Brand



PM-2701

**Fomon Dorsal Scissors (TC)**

Catalog#	Description	Length
PM-2725	Angled	5-1/2" (140 mm)
21-604TC*	Angled	5-1/2" (140 mm)

\*Miltex® Brand



PM-2725

**Cottle Dorsal Scissors (TC)**

Catalog#	Description	Length
PM-2835	Angled	6" (152 mm)



PM-2835

### Metzenbaum Scissors (TC)

Catalog#	Description	Length
5-179TC*	Straight	5-1/2" (140 mm)
PM-2720	Straight	5-3/4" (146 mm)
PM-2760	Straight	7" (178 mm)
5-181TC*	Straight	7" (178 mm)
PM-2795	Straight	9" (229 mm)
5-186TC*	Straight	9" (229 mm)
PM-2722	Straight, Sharp	5-3/4" (146 mm)
5-180TC*	Curved	5-1/2" (140 mm)
PM-2710	Curved	5-3/4" (146 mm)
PM-2750	Curved	7" (178 mm)
5-182TC*	Curved	7" (178 mm)
5-184TC*	Curved	8" (203 mm)
PM-2790	Curved	9" (229 mm)
5-188TC*	Curved	9" (229 mm)
5-189A-TC*	Curved	10" (254 mm)
PM-2752	Curved, Sharp	7" (178 mm)
PM-2792	Curved, Sharp	9" (229 mm)



PM-2720



PM-2722

\*Miltex® Brand

### Metzenbaum Scissors, Delicate (TC)

Catalog#	Description	Length
5-179A-TC*	Delicate, Straight	5-1/2" (140 mm)
PM-2761	Delicate, Straight	7" (178 mm)
5-181A-TC*	Delicate, Straight	7" (178 mm)
5-187TC*	Delicate, Straight	9" (229 mm)
5-179B-TC*	Delicate, Straight, Sharp	5-1/2" (140 mm)
5-181B-TC*	Delicate, Straight, Sharp	7" (178 mm)
5-182A-TC	Delicate, Curved	7" (178 mm)
5-180A-TC*	Delicate, Curved	5-1/2" (140 mm)
PM-2711	Delicate, Curved	5-3/4" (146 mm)
PM-2751	Delicate, Curved	7" (178 mm)
PM-2791	Delicate, Curved	9" (229 mm)
5-189TC*	Delicate, Curved	9" (229 mm)
5-180B-TC*	Delicate, Curved, Sharp	5-1/2" (140 mm)
PM-2712	Delicate, Curved, Sharp	5-3/4" (146 mm)
5-182B-TC*	Delicate, Curved, Sharp	7" (178 mm)



5-179A-TC

\*Miltex® Brand

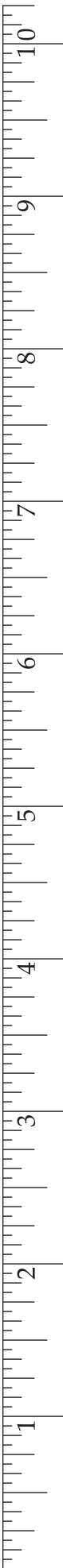

**Mayo Scissors (TC), Rounded Blades**

Catalog#	Description	Length
5-136TC*	Straight	5-1/2" (140 mm)
PM-2810	Straight	6" (152 mm)
PM-2830	Straight	6-3/4" (171 mm)
5-140TC*	Straight	6-3/4" (171 mm)
5-138TC*	Curved	5-1/2" (140 mm)
PM-2800	Curved	6" (152 mm)
5-142TC*	Curved	6-3/4" (171 mm)
PM-2820	Curved	6-3/4" (171 mm)

\*Miltex® Brand



5-140TC

**Mayo Scissors (TC), Beveled Blades**

Catalog#	Description	Length
5-120TC*	Straight	5-1/2" (140 mm)
5-124TC*	Straight	6-3/4" (171 mm)
5-128TC*	Straight	9" (229 mm)
5-122TC*	Curved	5-1/2" (140 mm)
5-126TC*	Curved	6-3/4" (171 mm)
5-130TC*	Curved	9" (229 mm)

\*Miltex® Brand



5-124TC

**Nelson Scissors (TC)**

Catalog#	Description	Length
5-192TC*	Curved	11" (279 mm)
5-193A-TC*	Curved	12" (305 mm)

\*Miltex® Brand



5-192TC



**PAR Scissors (TC)**

Catalog#	Description	Length
PM-2930	Delicate, Curved	4-1/2" (114 mm)
PM-2911	Delicate, Curved	5-3/4" (146 mm)



PM-2930

**Rees Scissors, Saber-Back Blades (TC)**

Catalog#	Description	Length
PM-6586	Straight, 2 Serrated Blades	6-1/2" (165 mm)
PM-6587	Curved, 2 Serrated Blades	6-1/2" (165 mm)



PM-6586

**Davis Scissors (TC)**

Catalog#	Description	Length
PM-2946	Sharp, Curved, 1 Serrated Blade	7" (178 mm)



PM-2946





**Kaye-Freeman Face Lift Scissors, Saber-Back (TC)**

Catalog#	Description	Length
PM-2978	Curved, 1 Serrated Blade	7" (178 mm)
21-710TC*	Curved, 1 Serrated Blade	7" (178 mm)

\*Miltex® Brand



PM-2978

**Kaye Scissors, Saber-Back (TC)**

Catalog#	Description	Length
PM-2979	Curved, 1 Serrated Blade	9" (229 mm)



PM-2979

**Kaye Face Lift Scissors, Saber-Back (TC)**

Catalog#	Description	Length
PM-29765	Curved, 1 Serrated Blade	7" (178 mm)
21-742TC*	Curved, 1 Serrated Blade	7" (178 mm)
PM-29865	Curved, 1 Serrated Blade	5-3/4" (146 mm)
21-740TC*	Curved, 1 Serrated Blade	5-3/4" (146 mm)

\*Miltex® Brand



PM-29765



PM-29865



### Gorney Face Lift Scissors, Saber-Back (TC)

Catalog#	Description	Length
PM-2991	Straight, 1 Serrated Blade	7-1/4" (184 mm)
PM-2992	Curved, 1 Serrated Blade	7-1/4" (184 mm)
21-608TC*	Curved, 1 Serrated Blade	7-1/2" (191 mm)
PM-2799	Straight, 1 Serrated Blade	9" (229 mm)

\*Miltex® Brand



PM-2991

### Gorney Platysma Scissors, Saber-Back (TC)

Catalog#	Description	Length
PM-2996	Curved, 1 Serrated Blade	9" (229 mm)



PM-2996

### Gorney-Freeman Scissors, Saber-Back (TC)

Catalog#	Description	Length
PM-2993	Straight, 1 Serrated Blade	7-1/4" (184 mm)
PM-2994	Curved, 1 Serrated Blade	7-1/4" (184 mm)
21-715TC*	Curved, 1 Serrated Blade	7-1/4" (184 mm)

\*Miltex® Brand



PM-2993

### Gorney Turbinate Scissors (TC)

Catalog#	Description	Length
PM-2997	Double Action, Angled, 2 Serrated Blades	8-1/4" (210 mm)



PM-2997

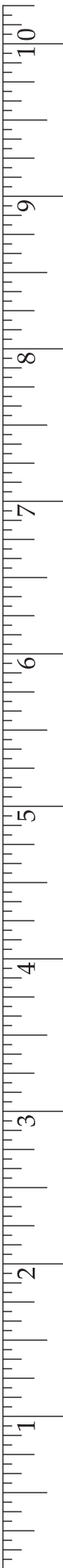



### Knight Nasal Scissors (TC)

Catalog#	Description	Length
PM-2837	Angled, 1 Serrated Blade	6-3/4" (171 mm)



PM-2837

### Padgett Septal Scissors (TC)

Catalog#	Description	Length
PM-2838	1 Serrated Blade, Longer Blades	7-3/4" (197 mm)

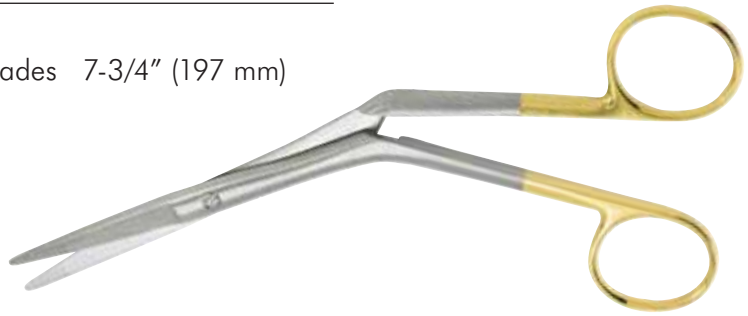

PM-2838

### Hood Iris Scissors (TC)

Catalog#	Description	Length
PM-4772	Straight, Square Shanks, Sharp	4-1/2" (114 mm)
PM-4773	Curved, Square Shanks, Sharp	4-1/2" (114 mm)



PM-4772

### Padgett Iris Scissors (TC)

Catalog#	Description	Length
PM-2706	Straight, Round Shanks, Sharp	4-1/2" (114 mm)
PM-2705	Curved, Round Shanks, Sharp	4-1/2" (114 mm)



PM-2706

### Iris Scissors (TC)

Catalog#	Description	Length
5-304TC*	Straight, Sharp	4-1/2" (114 mm)
5-306TC*	Curved, Sharp	4-1/2" (114 mm)

\*Miltex® Brand



5-304TC

### Peck-Joseph Scissors, Saber-Back (TC)

Catalog#	Description	Length
PM-2990	Curved, 1 Serrated Blade, Semi-Sharp	5-1/2" (140 mm)



PM-2990

### Joseph Scissors (TC)

Catalog#	Description	Length
PM-6422	Curved, Non-Serrated, Sharp	5-3/4" (146 mm)
PM-2988	Straight, 1 Serrated Blade, Sharp	5-3/4" (146 mm)



PM-2988

### Padgett Blepharoplasty Scissors (TC)

Catalog#	Description	Length
PM-6435	Delicate, Curved, 1 Serrated Blade	4-1/2" (114 mm)
21-537TC*	Delicate, Curved, 1 Serrated Blade	4-1/2" (114 mm)

\*Miltex® Brand

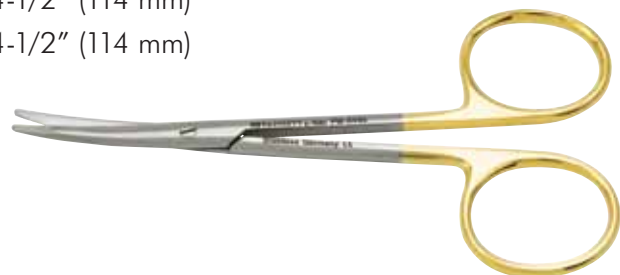

PM-6435



**Greenberg Par Scissors (TC)**

Catalog#	Description	Length
----------	-------------	--------

PM-2908 Curved, 1 Serrated Blade 4-1/2" (114 mm)



PM-2908

**Kaye Blepharoplasty Scissors (TC)**

Catalog#	Description	Length
----------	-------------	--------

PM-29065 Curved, 1 Serrated Blade 4-1/2" (114 mm)  
 5-269TC\* Curved, 1 Serrated Blade 4-1/2" (114 mm)



PM-29065

\*Miltex® Brand

**Padgett-Stevens Tenotomy Scissors (TC)**

Catalog#	Description	Length
----------	-------------	--------

PM-4843 Curved, 1 Serrated Blade, Sharp 5" (127 mm)



PM-4843

**Stevens Tenotomy Scissors (TC)**

Catalog#	Description	Length
----------	-------------	--------

PM-6436 Curved, Semi-Sharp, Non-Serrated 4-1/2" (114 mm)

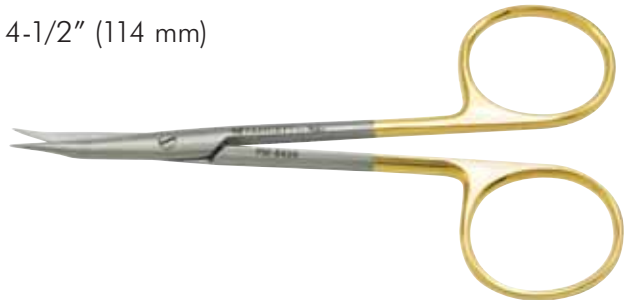

PM-6436

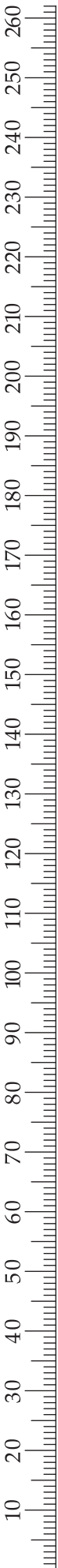

### Suture Wire Cutting Scissors (TC)

Catalog#	Description	Length
----------	-------------	--------

9-124TC*	Angled to Side, 1 Serrated Blade	4-3/4" (121 mm)
----------	----------------------------------	-----------------

\*Miltex® Brand



9-124TC

### Converse (Wilmer) Scissors (TC)

Catalog#	Description	Length
----------	-------------	--------

18-1440TC*	Blades Angled on Flat, Sharp	4-1/2" (114 mm)
------------	------------------------------	-----------------

\*Miltex® Brand



18-1440TC

### Giunta Nasal Scissors, Saber-Back (TC)

Catalog#	Description	Length
----------	-------------	--------

PM-2943	Blades and Handles Angled on Flat Semi-Sharp, 1 Serrated Blade	5" (127 mm)
---------	---	-------------

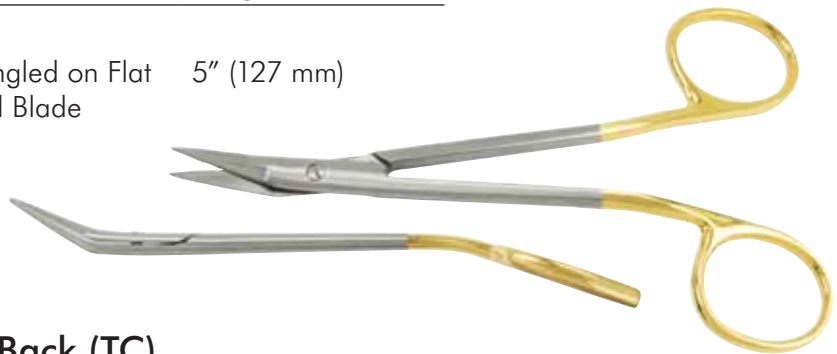

PM-2943

### Friedland Scissors, Saber-Back (TC)

Catalog#	Description	Length
----------	-------------	--------

PM-2950	Straight, 1 Serrated Blade	6-3/4" (171 mm)
PM-2951	Curved, 1 Serrated Blade	6-3/4" (171 mm)
PM-2955	Straight, 1 Serrated Blade	9" (229 mm)
PM-2956	Curved, 1 Serrated Blade	9" (229 mm)



PM-2951

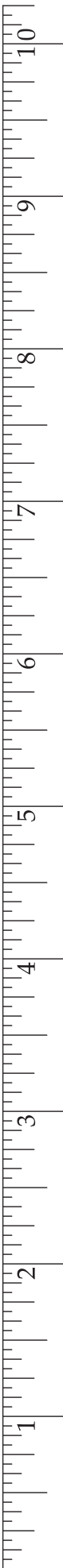



### Hinderer Rhytidectomy Scissors (TC)

Catalog#	Description	Length
----------	-------------	--------

PM-2940 Angled on Side, 1 Serrated Blade 7-1/2" (191 mm)

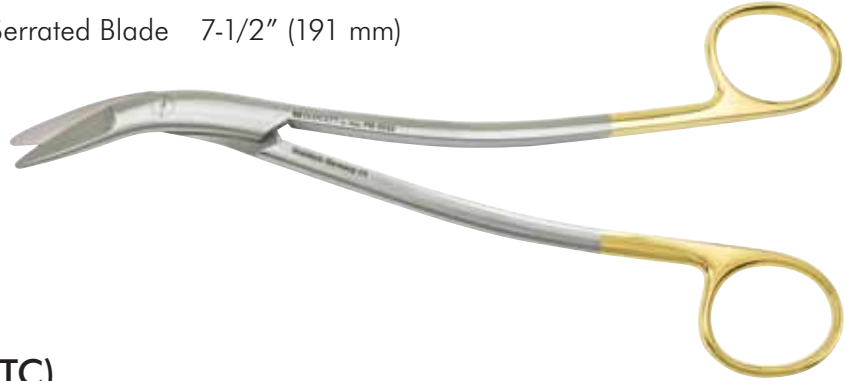

PM-2940

### Goldman-Fox Scissors (TC)

Catalog#	Description	Length
----------	-------------	--------

5-320TC\* Curved, Blunt 5" (127 mm)

\*Miltex® Brand



5-320TC

### Z-Type Scissors (TC)

Catalog#	Description	Length
----------	-------------	--------

- 30-2101TC\* Slight Curve 9" (229 mm)
- 30-2102TC\* Curve 9" (229 mm)
- 30-2103TC\* Full Curve 9" (229 mm)
- 30-2105TC\* Slight Curve 10-1/2" (267 mm)
- 30-2106TC\* Curve 10-1/2" (267 mm)
- 30-2107TC\* Full Curve 10-1/2" (267 mm)
- 30-2109TC\* Slight Curve 12" (305 mm)
- 30-2110TC\* Curve 12" (305 mm)
- 30-2111TC\* Full Curve 12" (305 mm)



30-2101TC 30-2102TC 30-2103TC  
 30-2105TC 30-2106TC 30-2107TC  
 30-2109TC 30-2110TC 30-2111TC

\*Miltex® Brand



30-2101TC

### Verdi Cleft Palate Scissors

Catalog#	Description	Length
----------	-------------	--------

PM-9015	S-Curved with Sharp Tenotomy Tips	8" (203 mm)
---------	-----------------------------------	-------------

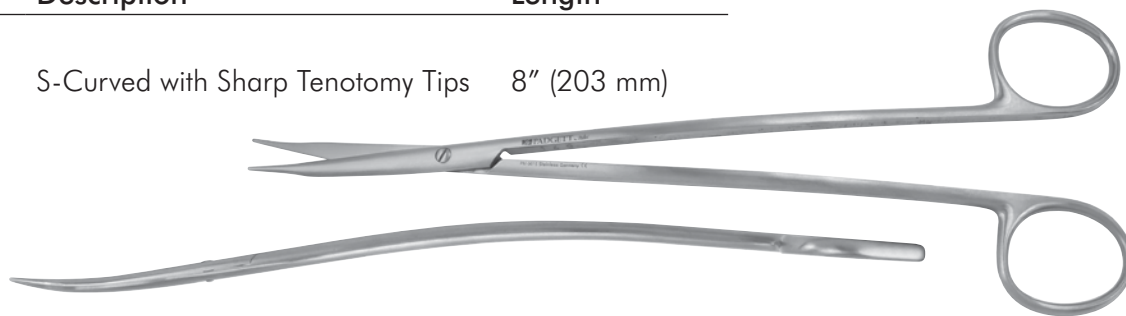

PM-9015

### Clodius Dissecting Scissors, Saber-Back

Catalog#	Description	Length
----------	-------------	--------

PM-6535	Curved, Sharp	6" (152 mm)
---------	---------------	-------------



PM-6535

### Converse Dissecting Scissors

Catalog#	Description	Length
----------	-------------	--------

PM-6550	Curved, Sharp	5-1/2" (140 mm)
---------	---------------	-----------------



PM-6550

### Quimby Gum Scissors

Catalog#	Description	Length
----------	-------------	--------

PM-6560	Straight, Non-Serrated, Sharp	5" (127 mm)
---------	-------------------------------	-------------

21-558*	Strongly Curved, Non-Serrated, Sharp 15mm Blades	5" (127 mm)
---------	--	-------------



21-558

\*Miltex® Brand

**Fine Pointed Scissors**

Catalog#	Description	Length
PM-0404	Straight, Sharp	4-1/2" (114 mm)
PM-0406	Curved, Sharp	4-1/2" (114 mm)
PM-0407	Heavy Shank, Curved, Sharp	4-1/2" (114 mm)
PM-0408	Curved, Blunt	4-1/2" (114 mm)
PM-0410	Straight, Blunt	4-1/2" (114 mm)

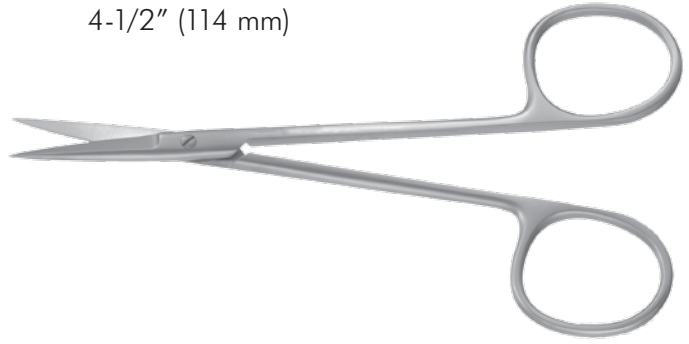

PM-0404

**Alar Cartilage Scissors**

Catalog#	Description	Length
PM-0416	Curved, Sharp	4-3/4" (121 mm)
PM-6515	Curved, Sharp	5-1/4" (133 mm)



PM-0416

**Aufricht Fine Scissors**

Catalog#	Description	Length
PM-0418	Straight with Slender Chamfered Blades, Sharp	6" (152 mm)



PM-0418

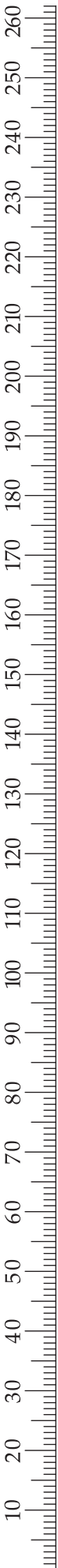



### Pickett Fine Dissecting Scissors

Catalog#	Description	Length
----------	-------------	--------

PM-2	Curved	5-3/4" (146 mm)
------	--------	-----------------



PM-2

### Mancusi-Ungaro Tissue Scissors

Catalog#	Description	Length
----------	-------------	--------

PM-3	Curved, Slight Bevel on Outer Edge of Blade, 1 Serrated Blade, Semi-Sharp	5" (127 mm)
------	---	-------------



PM-3

### Mancusi-Ungaro Face Lift Dissecting Scissors

Catalog#	Description	Length
----------	-------------	--------

PM-4	Curved	5-3/4" (146 mm)
PM-5	Curved	7" (178 mm)



PM-5

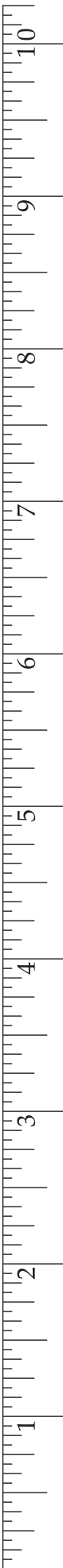

**Aufricht Dissecting Scissors**

Catalog#	Description	Length
PM-0422	Triangular Blades, Curved	5-1/2" (140 mm)
PM-0424	Triangular Blades, Straight	5-1/2" (140 mm)



**Barsky Double-Edged Scissors**

Catalog#	Description	Length
PM-0428	Curved, Semi-Sharp	6" (152 mm)



**Cartilage Scissors, Saber-Back**

Catalog#	Description	Length
PM-0430	Straight, Fine Pointed, 1 Serrated Blade	7-1/4" (184 mm)



**Cohneys Scissors Introducer**

Catalog#	Description	Length
PM-0432	Wide Fenestrated Blades, Tapering to Blunt Tips, Curved	7" (178 mm)

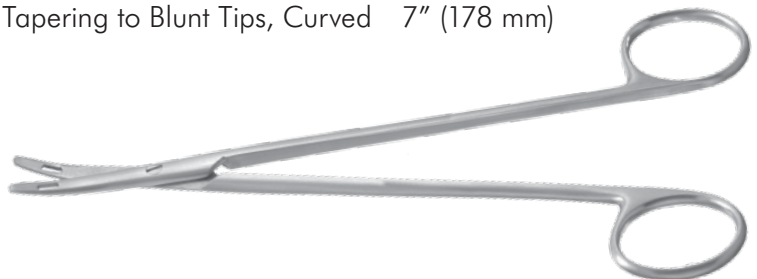

PM-0422

PM-0428

PM-0430

PM-0432

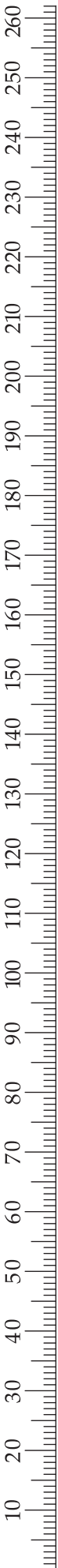

### East Grinstead Pattern Scissors

Catalog#	Description	Length
----------	-------------	--------

PM-0434	Curved with Flat Blunt Tips	4-1/2" (114 mm)
---------	-----------------------------	-----------------

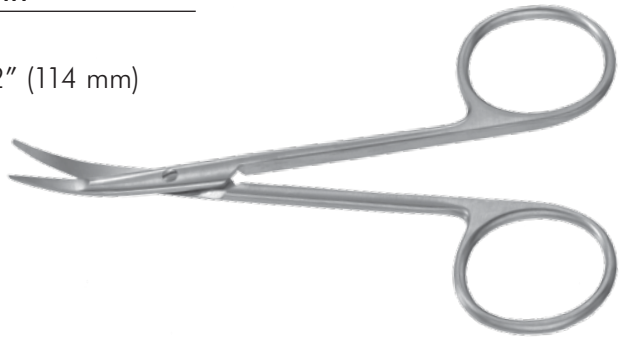

PM-0434

### Foster Scissors and Needle Holder

Catalog#	Description	Length
----------	-------------	--------

PM-0438	Straight, with Smooth Jaws	4-1/4" (108 mm)
---------	----------------------------	-----------------



PM-0438

### Foster Scissors and Needle Holder

Catalog#	Description	Length
----------	-------------	--------

PM-0440	Curved, with Serrated Jaws	5" (127 mm)
---------	----------------------------	-------------



PM-0440

### Heath Suture/Stitch Scissors

Catalog#	Description	Length
----------	-------------	--------

9-96*	With 1 Serrated Blade	6-1/8" (156 mm)
-------	-----------------------	-----------------



9-96

\*Miltex® Brand





**Kilner Scissors**

Catalog#	Description	Length
PM-0448	Straight with Fine Sharp Tips	4-1/2" (114 mm)
PM-0450	Curved with Flattened Blunt Tips	4-1/2" (114 mm)
PM-0452	Angled with Flattened Blunt Tips	5" (127 mm)



PM-0448



PM-0450

**McIndoe Scissors**

Catalog#	Description	Length
PM-0456	Curved with Round Tips	7" (178 mm)

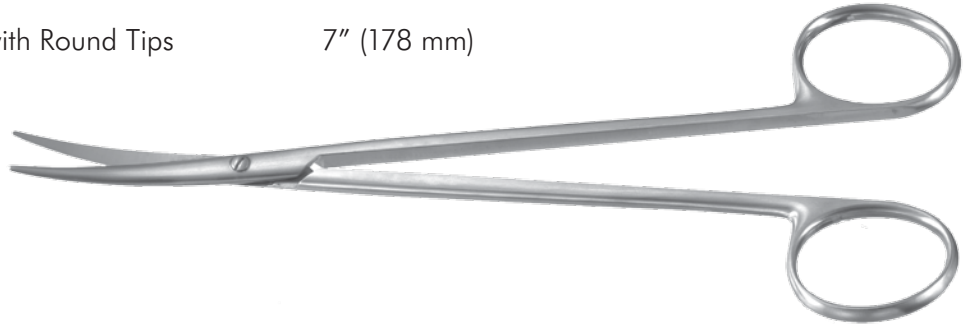

PM-0456

**Reynolds Dissecting Scissors - Tenotomy Type**

Catalog#	Description	Length
5-172*	Curved, Semi-Sharp	6" (152 mm)
5-174*	Curved, 1 Serrated Blade, Semi-Sharp	6" (152 mm)
5-176*	Curved, Semi-Sharp	7" (178 mm)
5-178*	Curved, 1 Serrated Blade, Semi-Sharp	7" (178 mm)

\*Miltex® Brand



5-172

### Dahlgren Iris Scissors

Catalog#	Description	Length
PM-4200	Straight, Sharp	4-1/8" (105 mm)
PM-4201	Curved, Sharp	4-1/8" (105 mm)

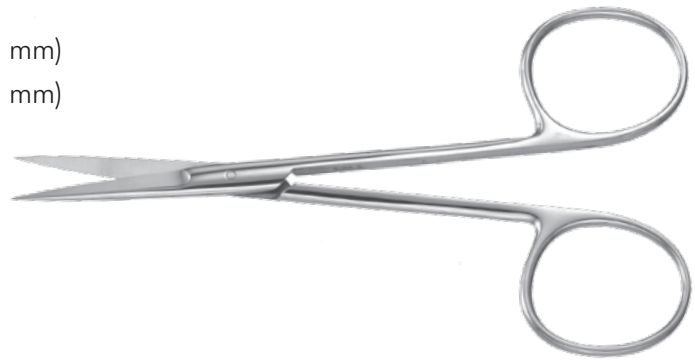

PM-4200

### Padgett & Miltex Iris Scissors

Catalog#	Description	Length
PM-4202	Straight, Sharp/Sharp, Heavy Pattern	4-1/2" (114 mm)
18-1396*	Straight, Sharp/Sharp, Delicate 20 mm Blades	3-1/2" (89 mm)
5-300*	Straight, Sharp/Sharp	4" (102 mm)
5-304*	Straight, Sharp/Sharp	4-1/2" (114 mm)
PM-4246	Straight, Sharp/Blunt	4-1/2" (114 mm)
PM-4247	Straight, Blunt/Blunt	4-1/2" (114 mm)
18-1398*	Curved, Sharp/Sharp, Delicate 20 mm Blades	3-1/2" (89 mm)
5-302*	Curved, Sharp/Sharp	4" (102 mm)
5-306*	Curved, Sharp/Sharp	4-1/2" (114 mm)
PM-4249	Curved, Sharp/Blunt	4-1/2" (114 mm)
PM-4250	Curved, Blunt/Blunt	4-1/2" (114 mm)
5-308*	Angled to Side, Sharp/Sharp	4-1/2" (114 mm)

\*Miltex® Brand

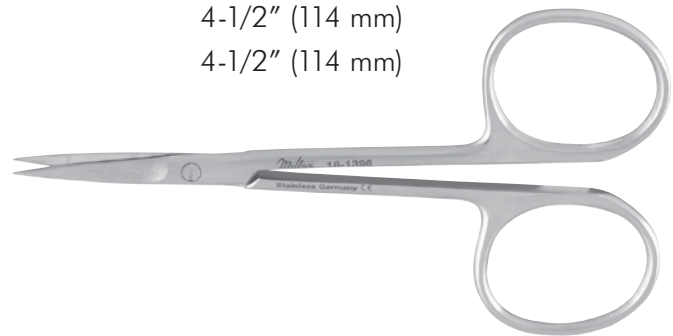

18-1396



5-304

### Padgett Iris Scissors, Ribbon Type

Catalog#	Description	Length
PM-4701	Delicate, Straight, Sharp, Short Blades	3-3/4" (95 mm)
PM-4702	Delicate, Curved, Sharp, Short Blades	3-3/4" (95 mm)
PM-4703	Delicate, Straight, Sharp, Long Blades	4" (102 mm)
PM-4704	Delicate, Curved, Sharp, Long Blades	4" (102 mm)



PM-4703

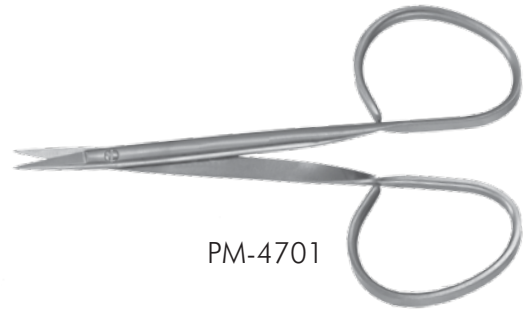

PM-4701

### Knapp Iris Scissors

Catalog#	Description	Length
18-1420*	Straight, Sharp/Blunt	4" (102 mm)
18-1426*	Curved, Sharp/Blunt	4" (102 mm)
18-1422*	Straight, Blunt/Blunt	4" (102 mm)
18-1428*	Curved, Blunt/Blunt	4" (102 mm)

\*Miltex® Brand



18-1420

### Thomas Iris Scissors

Catalog#	Description	Length
PM-3100	Straight, Delicate, Semi-Sharp	4-1/2" (114 mm)
PM-3102	Curved, Delicate, Semi-Sharp	4-1/2" (114 mm)

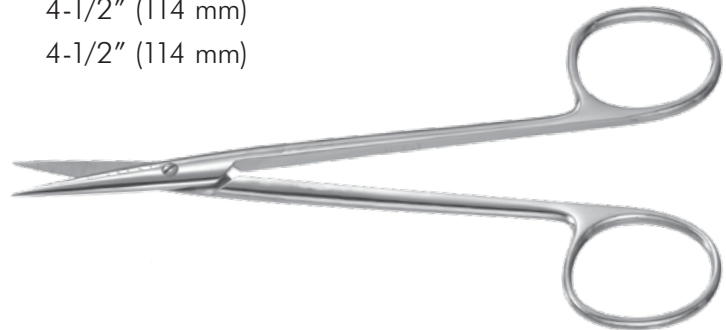

PM-3100

### Walker Iris Scissors

Catalog#	Description	Length
PM-4635	Curved to Side, Sharp	4-1/2" (114 mm)



PM-4635

### Graul Iris Scissors

Catalog#	Description	Length
PM-4931	Straight, Delicate, Sharp, Large Rings	4" (102 mm)
PM-4930	Curved, Delicate, Sharp, Large Rings	4" (102 mm)

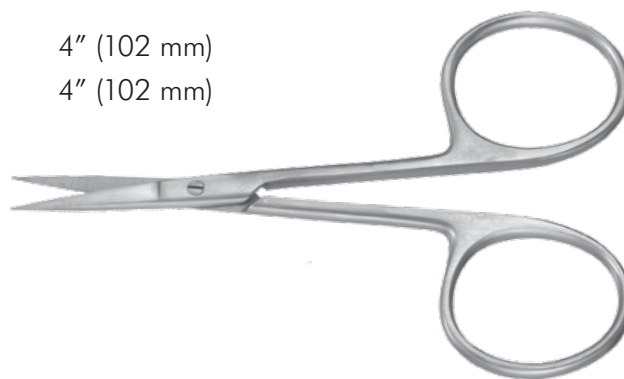

PM-4931

### Iris Suture Scissors, Ribbon Type

Catalog#	Description	Length
18-1653*	Slightly Curved, Sharp	4" (102 mm)

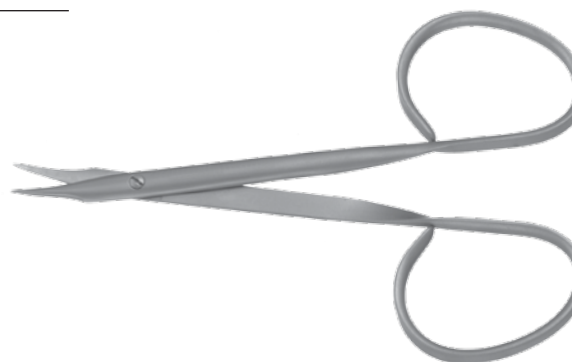

18-1653

\*Miltex® Brand

### Dean Tonsil & Dissecting Scissors

Catalog#	Description	Length
5-264*	Angled Blades, S-Shaped, 1 Serrated Blade, Sharp	6-3/4" (171 mm)

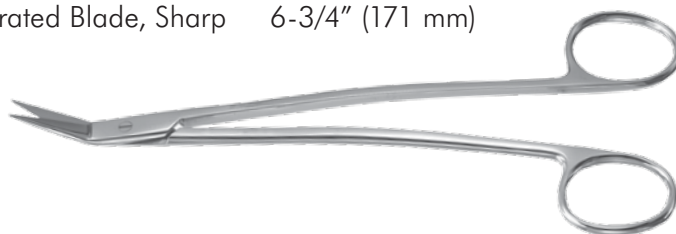

5-264

\*Miltex® Brand



### Mayo-Noble Dissecting Scissors

Catalog#	Description	Length
5-148*	Straight, Heavy Model, Beveled Blade	6-1/2" (165 mm)
5-150*	Curved, Heavy Model, Beveled Blade	6-1/2" (165 mm)



5-148

\*Miltex® Brand

### Mayo-Noble Dissecting Scissors

Catalog#	Description	Length
5-144*	Straight, Heavy Model, Rounded Blade	6-1/2" (165 mm)
5-146*	Curved, Heavy Model, Rounded Blade	6-1/2" (165 mm)



5-144

\*Miltex® Brand

### Mayo Dissecting Scissors

Catalog#	Description	Length
5-120*	Straight, Beveled Blade	5-1/2" (140 mm)
5-122*	Curved, Beveled Blade	5-1/2" (140 mm)
5-124*	Straight, Beveled Blade	6-3/4" (171 mm)
5-126*	Curved, Beveled Blade	6-3/4" (171 mm)



5-120

\*Miltex® Brand



## Mayo Scissors

Catalog#	Description	Length
PM-0460	Straight, Blunt, Beveled Blade	5-1/2" (140 mm)
PM-0462	Straight, Blunt, Beveled Blade	6-1/2" (165 mm)
PM-0464	Straight, Blunt, Beveled Blade	7-1/2" (191 mm)
PM-0470	Curved, Blunt, Beveled Blade	6-1/2" (165 mm)
PM-0472	Curved, Blunt, Beveled Blade	7-1/2" (191 mm)
PM-0474	Curved, Blunt, Beveled Blade	8-1/2" (216 mm)



PM-0462

## Mayo Dissecting Scissors

Catalog#	Description	Length
5-136*	Straight, Rounded Blade	5-1/2" (140 mm)
5-138*	Curved, Rounded Blade	5-1/2" (140 mm)
5-140*	Straight, Rounded Blade	6-3/4" (171 mm)
5-142*	Curved, Rounded Blade	6-3/4" (171 mm)

\*Miltex® Brand



5-136

## Metzenbaum Scissors

Catalog#	Description	Length
5-283*	Straight, Delicate	5" (127 mm)
PM-6475	Straight, Delicate	7" (178 mm)
5-183*	Straight, Delicate	8" (203 mm)
5-187*	Straight, Delicate	9" (229 mm)
5-284*	Curved, Delicate	5" (127 mm)
5-286*	Curved, Delicate	6" (152 mm)
5-288*	Curved, Delicate	7" (178 mm)
5-185*	Curved, Delicate	8" (203 mm)
5-189*	Curved, Delicate	9" (229 mm)
5-179*	Straight	5-1/2" (140 mm)
5-181*	Straight	7" (178 mm)
5-186*	Straight	9" (229 mm)
5-190*	Straight	11" (279 mm)
5-180*	Curved	5-1/2" (140 mm)
5-182*	Curved	7" (178 mm)
5-188*	Curved	9" (229 mm)
5-192*	Curved	11" (279 mm)



5-179

\*Miltex® Brand

**OR Scissors**

Catalog#	Description	Length
5-22*	Straight, Blunt/Blunt	4-1/2" (114 mm)
5-24*	Straight, Blunt/Blunt	5" (127 mm)
5-26*	Straight, Blunt/Blunt	5-1/2" (140 mm)
5-27*	Straight, Blunt/Blunt	6" (152 mm)
5-28*	Straight, Blunt/Blunt	6-1/2" (165 mm)
5-12*	Straight, Sharp/Blunt	4-1/2" (114 mm)
5-14*	Straight, Sharp/Blunt	5" (127 mm)
5-16*	Straight, Sharp/Blunt	5-1/2" (140 mm)
5-17*	Straight, Sharp/Blunt	6" (152 mm)
5-18*	Straight, Sharp/Blunt	6-1/2" (165 mm)
5-2*	Straight, Sharp/Sharp	4-1/2" (114 mm)
5-4*	Straight, Sharp/Sharp	5" (127 mm)
5-6*	Straight, Sharp/Sharp	5-1/2" (140 mm)
5-7*	Straight, Sharp/Sharp	6" (152 mm)
5-8*	Straight, Sharp/Sharp	6-1/2" (165 mm)
5-52*	Curved, Blunt/Blunt	4-1/2" (114 mm)
5-54*	Curved, Blunt/Blunt	5" (127 mm)
5-56*	Curved, Blunt/Blunt	5-1/2" (140 mm)
PM-4608	Curved, Blunt/Blunt	6" (152 mm)
5-58*	Curved, Blunt/Blunt	6-1/2" (165 mm)
5-42*	Curved, Sharp/Blunt	4-1/2" (114 mm)
5-44*	Curved, Sharp/Blunt	5" (127 mm)
5-46*	Curved, Sharp/Blunt	5-1/2" (140 mm)
PM-4618	Curved, Sharp/Blunt	6" (152 mm)
5-48*	Curved, Sharp/Blunt	6-1/2" (165 mm)
5-32*	Curved, Sharp/Sharp	4-1/2" (114 mm)
5-34*	Curved, Sharp/Sharp	5" (127 mm)
5-36*	Curved, Sharp/Sharp	5-1/2" (140 mm)
5-37*	Curved, Sharp/Sharp	6" (152 mm)
5-38*	Curved, Sharp/Sharp	6-1/2" (165 mm)

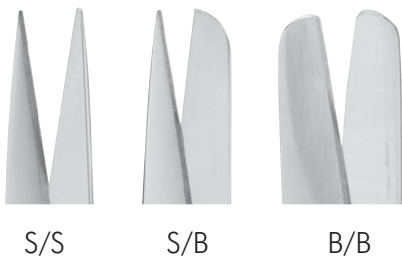

5-22

\*Miltex® Brand



**Padgett Suture Scissors, Ribbon Type**

Catalog#	Description	Length
----------	-------------	--------

PM-4638	Curved, Short Blades, Blunt	3-7/8" (98 mm)
---------	-----------------------------	----------------

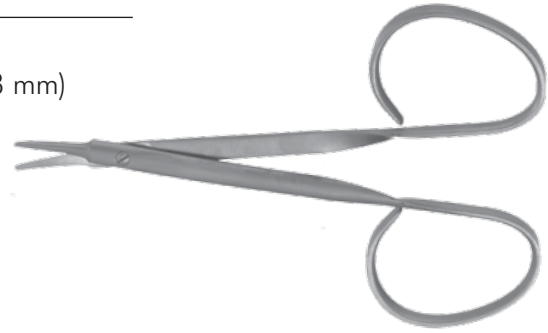

PM-4638

**Padgett Stitch Scissors, Ribbon Type**

Catalog#	Description	Length
----------	-------------	--------

PM-4639	Curved, Sharp	3-7/8" (98 mm)
---------	---------------	----------------



PM-4639

**Padgett Stevens Tenotomy Scissors, Ribbon Type**

Catalog#	Description	Length
----------	-------------	--------

PM-4641	Straight, Blunt	3-3/4" (95 mm)
PM-4642	Curved, Blunt	3-3/4" (95 mm)

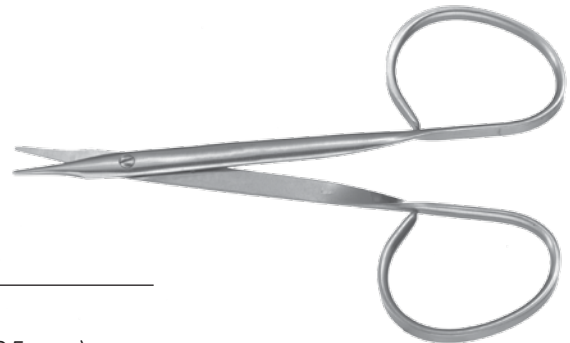

PM-4641

**Stevens Tenotomy Scissors**

Catalog#	Description	Length
----------	-------------	--------

18-1460*	Straight, Sharp, Short Blades	4-1/8" (105 mm)
18-1462*	Straight, Blunt, Short Blades	4-1/8" (105 mm)
18-1464*	Curved, Sharp, Short Blades	4-1/8" (105 mm)
18-1466*	Curved, Blunt, Short Blades	4-1/8" (105 mm)
18-1470*	Straight, Sharp, Long Blades	4-1/2" (114 mm)
18-1472*	Straight, Blunt, Long Blades	4-1/2" (114 mm)
18-1474*	Curved, Sharp, Long Blades	4-1/2" (114 mm)
18-1476*	Curved, Blunt, Long Blades	4-1/2" (114 mm)
18-1455*	Curved, Blunt	5-1/2" (140 mm)
18-1456*	Curved, Blunt	6-1/4" (159 mm)



18-1462

\*Miltex® Brand

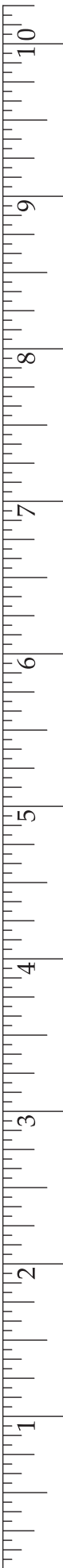

### Haynes Suture Scissors, Ribbon Type

Catalog#	Description	Length
PM-4648	Curved, Sharp	4-3/8" (111 mm)



PM-4648

### Strabismus Padgett Scissors, Ribbon Type

Catalog#	Description	Length
PM-4706	Straight, Blunt	4-1/8" (105 mm)
PM-4707	Curved, Blunt	4-1/8" (105 mm)



PM-4706

### Mosby Utility Scissors

Catalog#	Description	Length
PM-4718	Curved, Sharp	3-3/4" (95 mm)



PM-4718



### Miltex Utility Scissors, Ribbon Type

Catalog#	Description	Length
----------	-------------	--------

5-400\* Curved, Blunt Tips 4" (102 mm)

\*Miltex® Brand

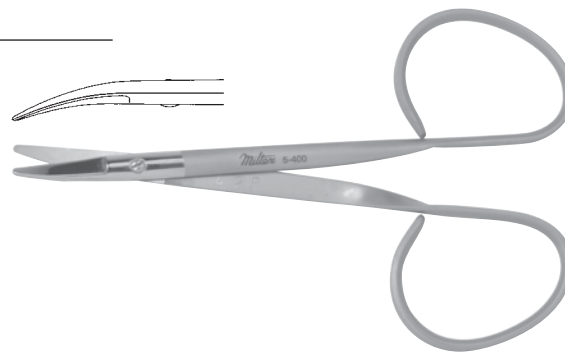

5-400

### Reeh Stitch Scissors, Ribbon Type

Catalog#	Description	Length
----------	-------------	--------

9-115\* Curved, Sharp Tips  
Small Hook at End  
of One Blade 3-3/4" (95 mm)

\*Miltex® Brand

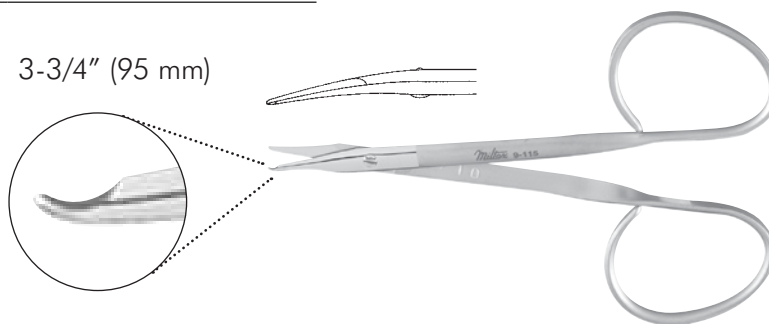

9-115

### Miltex Stitch Scissors, Ribbon Type

Catalog#	Description	Length
----------	-------------	--------

9-116\* Curved, Sharp 3-7/8" (98 mm)

\*Miltex® Brand



9-116

### Miltex Stitch Scissors, Ribbon Type

Catalog#	Description	Length
----------	-------------	--------

9-117\* Curved, Sharp 4-1/2" (114 mm)

\*Miltex® Brand

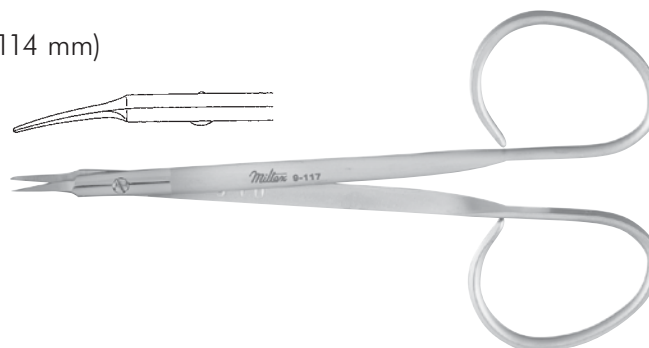

9-117

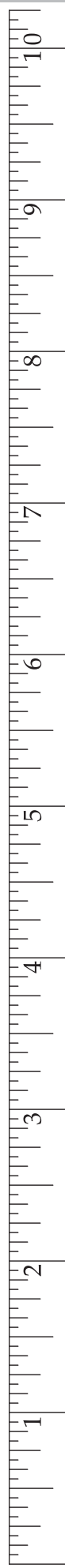

**Spencer Stitch Scissors**

Catalog#	Description	Length
----------	-------------	--------

9-100*	Straight	3-1/2" (89 mm)
PM-6751	Curved	3-1/2" (89 mm)

\*Miltex® Brand

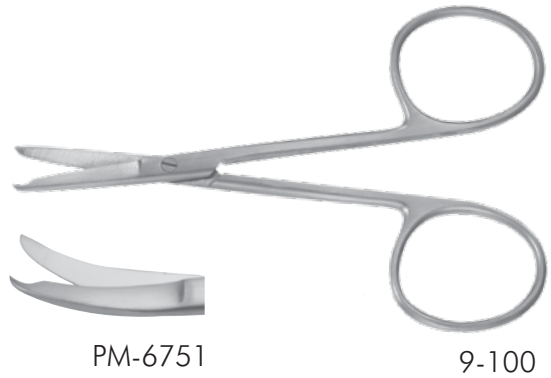

**O'Brien Stitch Scissors**

Catalog#	Description	Length
----------	-------------	--------

9-110*	Angled to Side, Sharp	3-3/4" (89 mm)
--------	-----------------------	----------------

\*Miltex® Brand



**Littler Plastic Surgery or Suture Scissors**

Catalog#	Description	Length
----------	-------------	--------

PM-6760	Curved	4-3/4" (121 mm)
---------	--------	-----------------



**Laschal Suture Scissors-Forceps**

Catalog#	Description	Length
----------	-------------	--------

PM-6770	Straight	4-1/2" (114 mm)
---------	----------	-----------------



**Laschal Suture Cutter**

Catalog#	Description	Length
----------	-------------	--------

PM-6780	Straight	6" (152 mm)
---------	----------	-------------

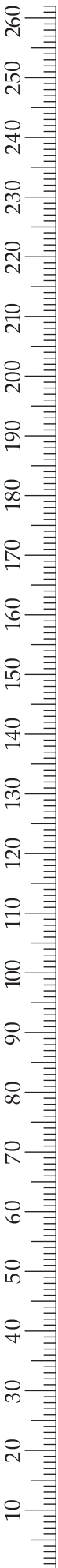
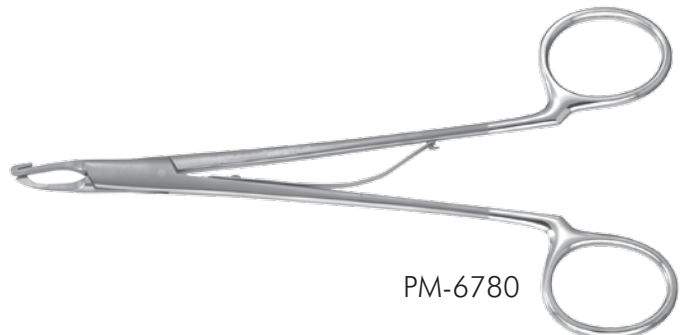

### Micro Scissors

Catalog#	Description	Length
17-2160*	Round Handle, Straight, Sharp, 6mm Blades	7-1/8" (181 mm)
17-2110*	Round Handle, Curved, Sharp, 6mm Blades	7-1/8" (181 mm)
17-2150*	Round Handle, Straight, Sharp, 6mm Blades	5-3/4" (146 mm)
17-2100*	Round Handle, Curved, Sharp, 6mm Blades	5-3/4" (146 mm)

\*Miltex® Brand



### Hood Micro Stitch Scissors

Catalog#	Description	Length
PM-4956	Curved, Sharp	4-1/2" (114 mm)



17-2160

PM-4956

### Hood Micro Dissecting Scissors

Catalog#	Description	Length
PM-4958	Straight, Sharp	4" (102 mm)
PM-4957	Curved, Sharp	4" (102 mm)



### Castanares Face Lift Scissors

Catalog#	Description	Length
PM-4769	Straight	6-1/2" (165 mm)
PM-4844	Straight	6" (152 mm)
PM-4969	Curved	5-3/4" (146 mm)



PM-4957

PM-4769

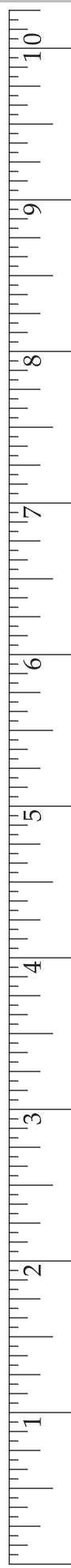





### Gorney Face Lift Scissors, Saber-Back

Catalog#	Description	Length
PM-4911	Curved, 1 Serrated Blade	5-1/4" (133 mm)
PM-4831	Straight, 2 Serrated Blades	7-1/4" (184 mm)
PM-4862	Curved, 2 Serrated Blades	7-1/4" (184 mm)
21-608*	Curved, 1 Serrated Blade	7-3/4" (197 mm)
21-607*	Straight, 1 Serrated Blade	7-3/4" (197 mm)
PM-4861	Straight, 2 Serrated Blades	9-3/4" (248 mm)

\*Miltex® Brand



PM-4831

### Gorney Nasal Cartilage Scissors, Saber-Back

Catalog#	Description	Length
PM-4863	Angled, 1 Serrated Blade	7" (178 mm)



PM-4863

### Freeman Face Lift Scissors

Catalog#	Description	Length
PM-4883	Curved, Blunt	7" (178 mm)



PM-4883

### Gorney Turbinate Scissors

Catalog#	Description	Length
PM-6595	Angled	6-5/8" (168 mm)



PM-6595



### Fomon Dorsal Scissors

Catalog#	Description	Length
----------	-------------	--------

21-604*	Angled Shanks, Light Pattern with Beveled Blades	5-1/2" (140 mm)
---------	--	-----------------

\*Miltex® Brand



21-604

### Cottle Dorsal Scissors

Catalog#	Description	Length
----------	-------------	--------

21-610*	Angled Shanks, Heavy Pattern with Rounded Blades	6" (152 mm)
---------	--	-------------

\*Miltex® Brand



21-610

### Vinas Cleft Palate Scissors

Catalog#	Description	Length
----------	-------------	--------

PM-4837	Curved	8" (203 mm)
---------	--------	-------------



PM-4837

### Miller Dissecting Scissors

Catalog#	Description	Length
----------	-------------	--------

PM-4889	Curved, Blunt	5" (127 mm)
---------	---------------	-------------



PM-4889





### Frederick Scissors

Catalog#	Description	Length
PM-4902	Curved	4-1/4" (108 mm)



PM-4902

### Kaye Blepharoplasty Scissors, Ribbon Type

Catalog#	Description	Length
PM-4955	Curved, 1 Serrated Blade	4-1/4" (108 mm)
5-263*	Curved, 1 Serrated Blade	4-1/4" (108 mm)



PM-4955

\*Miltex® Brand

### Caplan Septum Scissors

Catalog#	Description	Length
21-622*	2 Serrated Blades, Double-Action	8" (203 mm)



21-622

\*Miltex® Brand

### Becker Septum Scissors

Catalog#	Description	Length
PM-4892	2 Serrated Blades, Double-Action	7-1/8" (181 mm)



PM-4892

### Gorney Turbinate Scissors

Catalog#	Description	Length
----------	-------------	--------

21-621*	Double-Action, Angled, 2 Serrated Blades, 1-3/4" (44mm) Cut	7-3/4" (197 mm)
---------	---	-----------------

\*Miltex® Brand

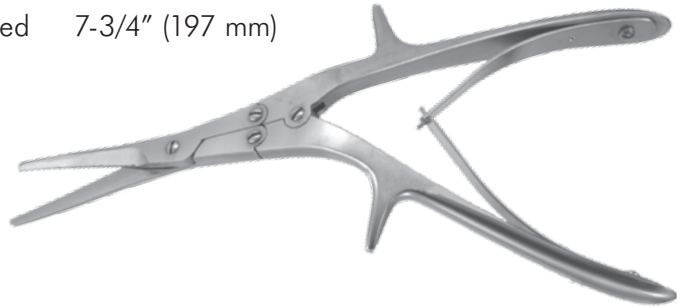

21-621

### Nasal & Plastic Surgery Scissors

Catalog#	Description	Length
----------	-------------	--------

5-270*	Straight, Sharp/Sharp	4-3/4" (121 mm)
5-271*	Straight, Sharp/Sharp, 1 Serrated Blade	4-3/4" (121 mm)
5-272*	Straight, Sharp/Blunt	4-3/4" (121 mm)
5-273*	Straight, Sharp/Blunt, 1 Serrated Blade	4-3/4" (121 mm)
5-274*	Straight, Blunt/Blunt	4-3/4" (121 mm)
5-275*	Straight, Blunt/Blunt, 1 Serrated Blade	4-3/4" (121 mm)
5-276*	Curved, Sharp/Sharp	4-3/4" (121 mm)
5-277*	Curved, Sharp/Sharp, 1 Serrated Blade	4-3/4" (121 mm)
5-278*	Curved, Sharp/Blunt	4-3/4" (121 mm)
5-279*	Curved, Sharp/Blunt, 1 Serrated Blade	4-3/4" (121 mm)
5-280*	Curved, Blunt/Blunt	4-3/4" (121 mm)
5-281*	Curved, Blunt/Blunt, 1 Serrated Blade	4-3/4" (121 mm)

\*Miltex® Brand

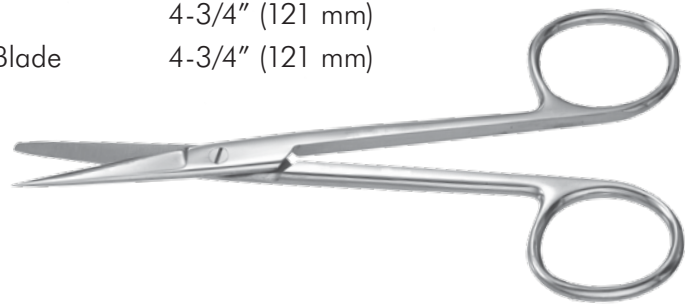

5-272

### Sealy Plastic Scissors

Catalog#	Description	Length
----------	-------------	--------

PM-6415	Straight, Sharp	4-1/4" (108 mm)
PM-6416	Curved, Sharp	4-1/4" (108 mm)

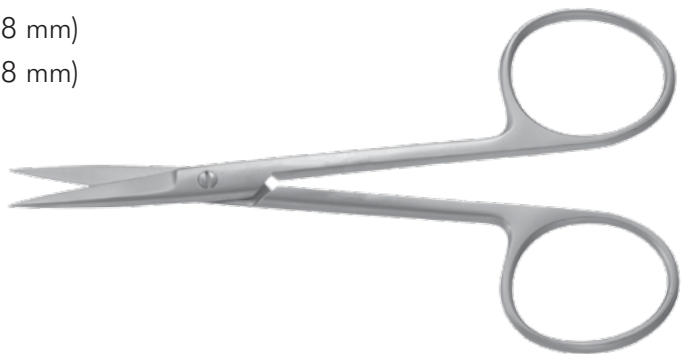

PM-6415

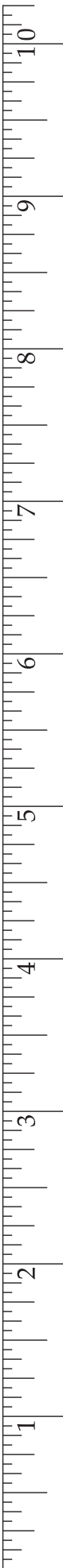

### Joseph Nasal Scissors

Catalog#	Description	Length
PM-6420	Straight, Sharp	6-1/4" (159 mm)
PM-6421	Curved, Sharp	6-1/4" (159 mm)



PM-6420

### Heymann Nasal Scissors

Catalog#	Description	Length
PM-4285	Blunt	7" (178 mm)



PM-4285

### Sims Dissecting Scissors

Catalog#	Description	Length
5-222*	Straight, Sharp/Blunt	8" (203 mm)

\*Miltex® Brand



5-222

### Converse Scissors

Catalog#	Description	Length
PM-6450	Angled, Semi-Sharp Tips, Flattened Thin Blades	4-1/8" (105 mm)
PM-6451	Angled, Semi-Sharp Tips, Saber-Back Blades	4-1/4" (108 mm)



### Padgett Nasal Cartilage Scissors

Catalog#	Description	Shaft Length	Length
PM-6591	Both Blades Serrated, Blunt	5" (127 mm)	8-1/2" (216 mm)



### Thorek Scissors

Catalog#	Description	Length
PM-4373	Full Curve	5-1/2" (140 mm)
5-244*	Full Curve	7-1/4" (184 mm)
5-245*	Full Curve	10" (254 mm)

\*Miltex® Brand



### Potts-Smith Scissors

Catalog#	Description	Length
5-246*	25 Degree Angled Tip, Semi-Sharp 20mm Blades	7-1/2" (191 mm)
5-247*	45 Degree Angled Tip, Semi-Sharp 20mm Blades	7-1/2" (191 mm)
5-248*	60 Degree Angled Tip, Semi-Sharp 20mm Blades	7-1/2" (191 mm)
5-249A*	25 Degree Angled Tip, Delicate Semi-Sharp 13mm Blades	7-1/2" (191 mm)
5-249B*	45 Degree Angled Tip, Delicate Semi-Sharp 13mm Blades	7-1/2" (191 mm)
5-249C*	60 Degree Angled Tip, Delicate Semi-Sharp 13mm Blades	7-1/2" (191 mm)

\*Miltex® Brand

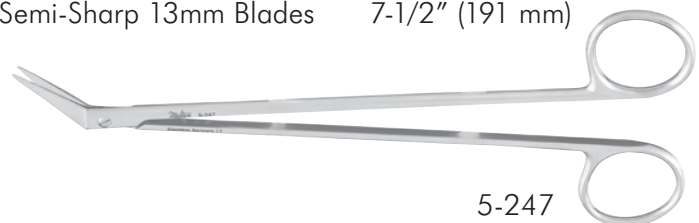

**Walden-Marshall Dissecting Scissors, Saber-Back**

Catalog#	Description	Length
----------	-------------	--------

PM-6480	Curved, Blunt, 2 Serrated Blades	10" (254 mm)
---------	----------------------------------	--------------

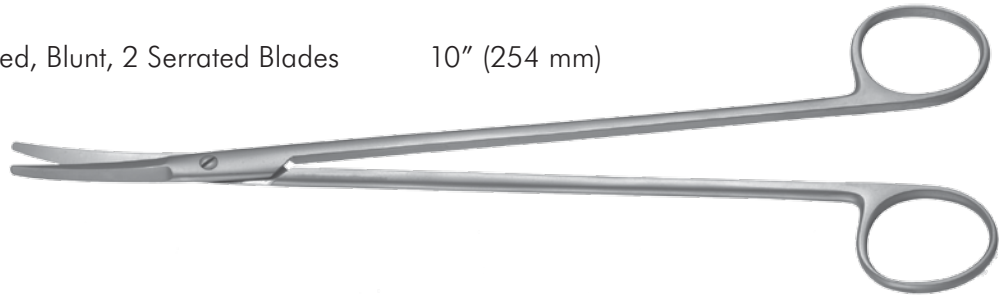

**Strabismus Scissors**

PM-6480

Catalog#	Description	Length
----------	-------------	--------

5-312*	Straight, Rounded Blades, Blunt	4" (102 mm)
--------	---------------------------------	-------------

5-314*	Curved, Rounded Blades, Blunt	4" (102 mm)
--------	-------------------------------	-------------



\*Miltex® Brand

**Boyd Scissors**

5-312

Catalog#	Description	Length
----------	-------------	--------

PM-6530	Double Curve, Blunt	7" (178 mm)
---------	---------------------	-------------



**Thin Point Nasal Scissors**

PM-6530

Catalog#	Description	Length
----------	-------------	--------

PM-6522	Curved, Blunt	7" (178 mm)
---------	---------------	-------------



PM-6522

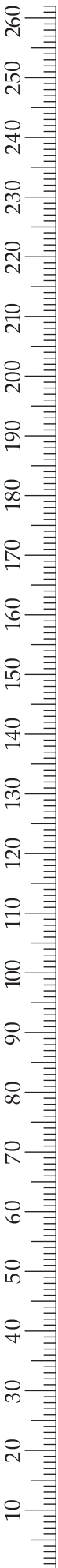

## Ragnell Undermining Scissors

Catalog#	Description	Length
PM-6540	Straight, Blunt	5-1/8" (130 mm)
PM-6541	Half Curved, Blunt	5-1/8" (130 mm)



PM-6541

## Kahn Dissecting Scissors, Saber-Back

Catalog#	Description	Length
5-265*	Straight, Blunt	5-1/2" (140 mm)
5-266*	Curved, Blunt	5-1/2" (140 mm)
5-267*	Straight, Blunt	7" (178 mm)
5-268*	Curved, Blunt	7" (178 mm)
PM-6548	Straight, Blunt	8" (203 mm)
PM-6549	Curved, Blunt	8" (203 mm)



5-265

\*Miltex® Brand

## Davis Face Lift Scissors

Catalog#	Description	Length
PM-6555	Curved, Semi-Sharp	6-3/4" (171 mm)



PM-6555

**Taylor Dural Scissors**

**Catalog# Length**

---

PM-6720 6-1/2" (165 mm)



PM-6720

**Cottle Bulldog Nasal Scissors**

**Catalog# Description Length**

---

21-612\* Slightly Curved, Blunt 4-1/2" (114 mm)

\*Miltex® Brand



21-612

**Kaye Face Lift Scissors, Saber-Back**

**Catalog# Description Length**

---

PM-6565 Curved, 2 Serrated Blades 7-1/2" (191 mm)

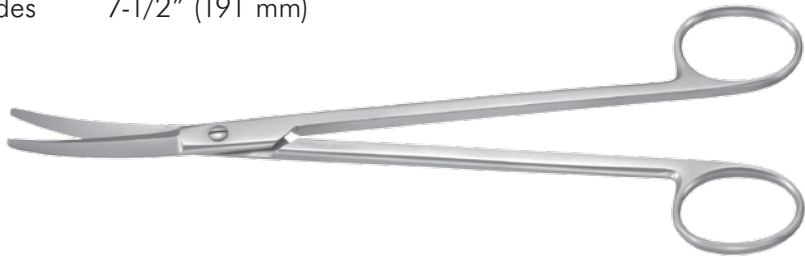

PM-6565

**Brophy Scissors**

**Catalog# Description Length**

---

5-316\* Straight, Sharp 5-1/2" (140 mm)

5-318\* Curved, Sharp 5-1/2" (140 mm)

5D-326\* Curved, Sharp, 1 Serrated Blade 5-1/2" (140 mm)

\*Miltex® Brand



5-316





### Wilkinson Face Lift Scissors, Saber-Back

Catalog#	Description	Length
----------	-------------	--------

PM-6573 Double Curved 7-1/2" (191 mm)



### Rees Face Lift Scissors, Saber-Back

Catalog#	Description	Length
----------	-------------	--------

PM-6575 Curved, 2 Serrated Blades 6-1/2" (165 mm)

PM-6574 Curved, 2 Serrated Blades 8" (203 mm)

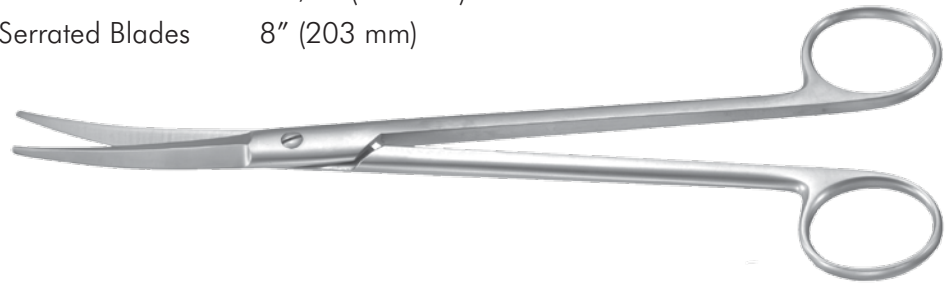

PM-6573

PM-6574

### Ortiz-Monasterio Face Lift Marking Scissors

Marks skin to be excised during face lifts. After the flap has been undermined, extension is placed into the non-undermined margin. The flap is pulled and the skin between the blades is cut.

Catalog#	Description	Length
----------	-------------	--------

PM-6576 Straight 5-1/2" (140 mm)



PM-6576

### Brown Dissecting Scissors

Catalog#	Description	Length
----------	-------------	--------

PM-6580 Straight 5-3/4" (146 mm)

PM-6581 Curved 5-3/4" (146 mm)



PM-6581

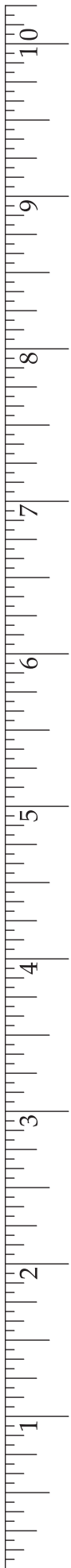

**Brown New Pattern Dissecting Scissors**

Catalog#	Description	Length
PM-6582	Straight, Heavy Handles, Delicate Blades	5-1/2" (140 mm)
PM-6583	Curved, Heavy Handles, Delicate Blades	5-1/2" (140 mm)

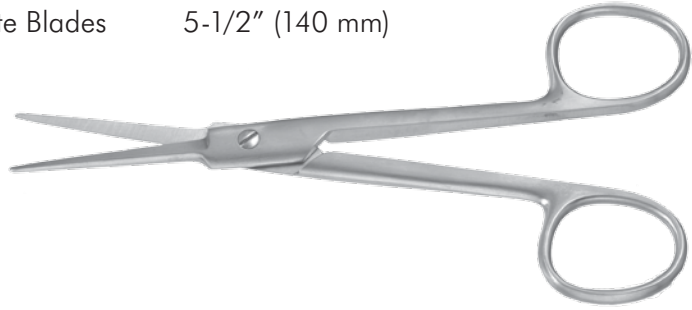

PM-6582

**Owsley Face Lift Scissors**

Catalog#	Description	Length
PM-6585	Curved, Blunt	6-3/4" (171 mm)



PM-6585

**Patton Scissors**

Catalog#	Description	Length
PM-6590	Strong Curve, Blunt	6-1/2" (165 mm)

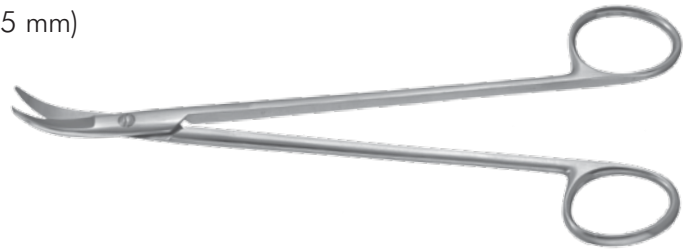

PM-6590

**Kilner Dissecting Scissors**

Catalog#	Description	Length
PM-6645	Curved, Blunt	5" (127 mm)
PM-6646	Curved, Blunt	5-3/8" (137 mm)



PM-6645

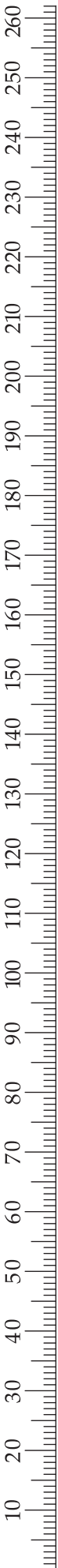

### Fomon Saber-Back Scissors

Catalog#	Description	Length
----------	-------------	--------

21-600*	Slightly Curved Blades with Semi-Sharp Outer Edges	5" (127 mm)
---------	--	-------------

\*Miltex® Brand



21-600

### Fomon Lower Lateral Scissors

Catalog#	Description	Length
----------	-------------	--------

21-602*	Strong Curve, Blunt Dissecting Blades	5" (127 mm)
---------	---------------------------------------	-------------

\*Miltex® Brand

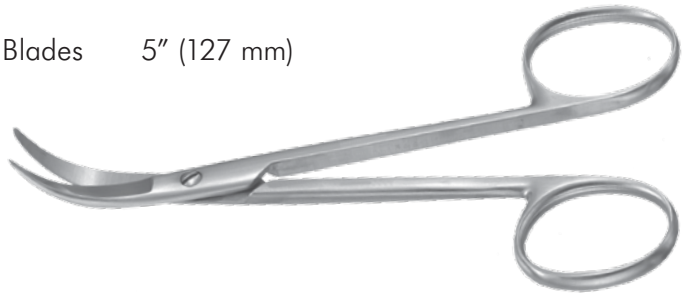

21-602

### Jackson Turbinate Scissors

Catalog#	Description	Length
----------	-------------	--------

PM-6596	Angled, Blunt	7-7/8" (200 mm)
---------	---------------	-----------------

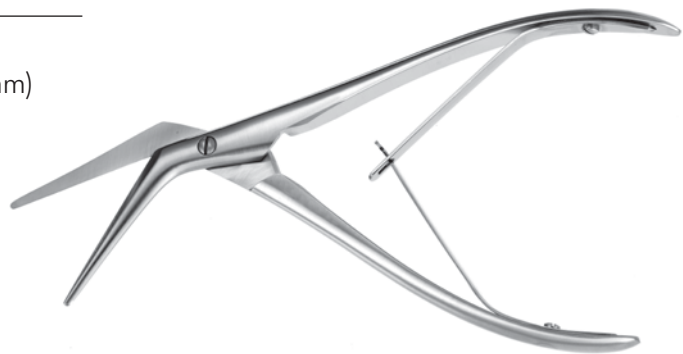

PM-6596

### Padgett Turbinate Scissors, Double-Action

Catalog#	Description	Length
----------	-------------	--------

PM-6598	Straight, 1 Serrated Blade, Narrow	8-1/2" (216 mm)
---------	------------------------------------	-----------------

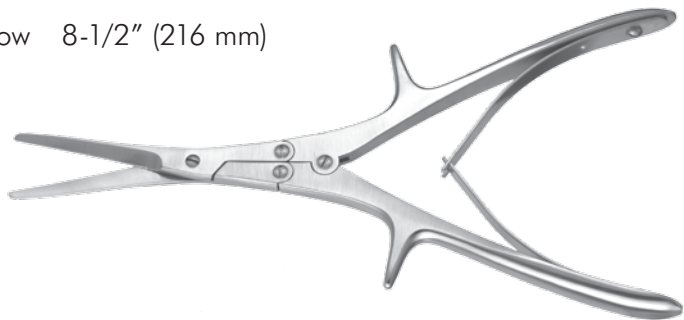

PM-6598

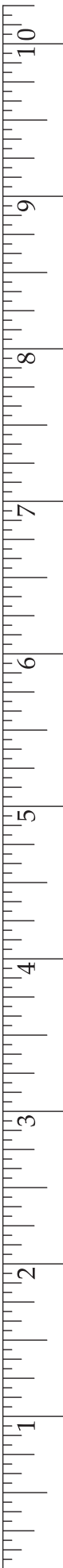



### Bellucci Alligator Scissors

Catalog#	Description	Shaft Length
19-2155*	7 mm Blades, Curved Left	3" (76 mm)
19-2156*	7 mm Blades, Curved Right	3" (76 mm)
19-2160*	7 mm Blades, Straight	3" (76 mm)



19-2155

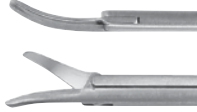

19-2156



19-2160

\*Miltex® Brand



19-2155

### House-Bellucci Alligator Scissors

Catalog#	Description	Shaft Length
19-2157*	5 mm Blades, Straight	3" (76 mm)
19-2158*	5 mm Blades, Curved Left	3" (76 mm)
19-2159*	5 mm Blades, Curved Right	3" (76 mm)



19-2157



19-2158



19-2159

\*Miltex® Brand



19-2157

### Nasal Scissors

Catalog#	Description	Shaft Length
20-170*	11 mm Blades, Straight	4-1/2" (114 mm)
20-171*	11 mm Blades, Curved Left	4-1/2" (114 mm)
20-172*	11 mm Blades, Curved Right	4-1/2" (114 mm)



20-170



20-171



20-172

\*Miltex® Brand

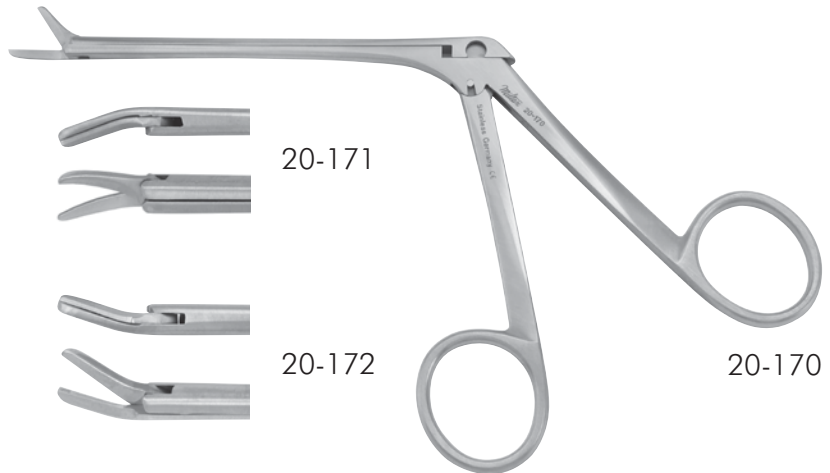

20-170

### Costa Wire/Suture Scissors

Catalog#	Description	Length
----------	-------------	--------

9-124*	Angled to Side, 1 Serrated Blade	4-3/4" (121 mm)
--------	----------------------------------	-----------------

\*Miltex® Brand



9-124

### Darling Eccentric Bandage Scissors

Catalog#	Description	Length
----------	-------------	--------

PM-4126	Heavy Duty, 1 Serrated Blade	6-1/2" (165 mm)
---------	------------------------------	-----------------



PM-4126

### Pantzer Hi-Level Bandage Scissors

Catalog#	Description	Length
----------	-------------	--------

PM-4841	1 Serrated Blade	5-1/2" (140 mm)
---------	------------------	-----------------



PM-4841

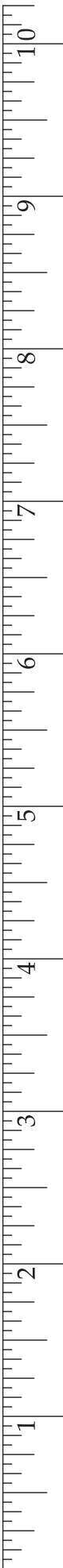

### Lister Bandage Scissors

Catalog#	Description	Length
5-510*		3-1/2" (89 mm)
5-512*		4-1/2" (114 mm)
5-514*		5-1/2" (140 mm)
5-516*		7-1/4" (184 mm)
5-550*	with 1 Large Finger Ring	8" (203 mm)



5-512



5-550

\*Miltex® Brand

### Knowles Bandage Scissors

Catalog#	Description	Length
5-560*	Straight	5-1/2" (140 mm)
5-561*	Angled to Side, 1 Serrated Blade	5-1/2" (140 mm)



5-560

\*Miltex® Brand

### Esmarch Bandage, Cast & Plaster Shears

Catalog#	Description	Length
5-568*	Heavy Duty	8" (203 mm)

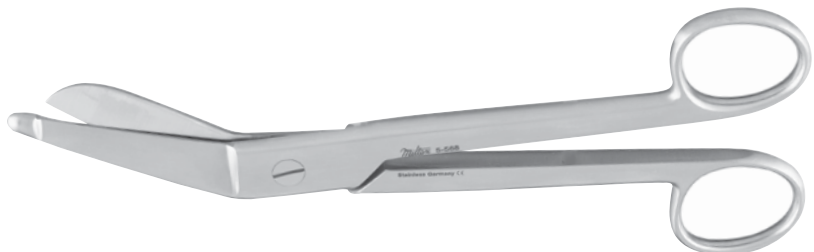

5-568

\*Miltex® Brand



# SPECIALTY PROCEDURE INSTRUMENTS

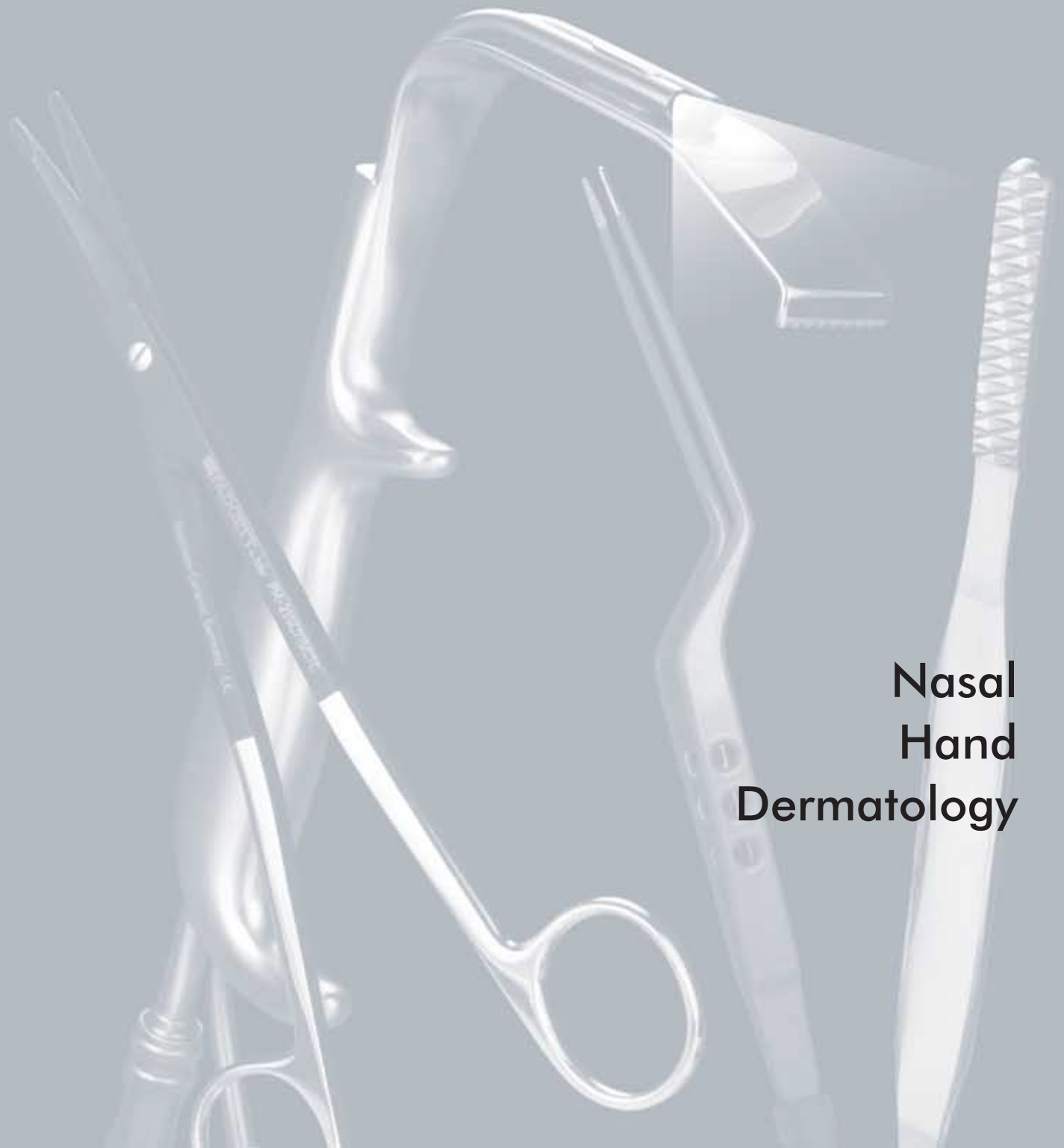

Nasal  
Hand  
Dermatology



## Sheen Grid

### Catalog# Description

PM-3755	Aluminum, Black on Silver
PM-3756	Aluminum, Silver on Black

Ideal for cutting, measuring, photographing cartilage grafts. Graduated in mm with bold cm markings.

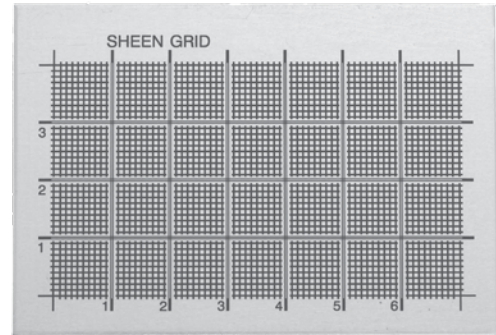

PM-3755

## Gruber Cartilage Cutting Block

### Catalog# Description Size

PM-0630	Silicone	4" x 4" (102 mm x 102 mm)
---------	----------	---------------------------



PM-0630

## Gruber Nasal Tip Sizers

### Catalog# Description

PM-878	Set of 3 Includes Small, Medium & Large, Reusable Silicone
--------	--



PM-878

## Small Plastic Tray with Silicone Mat

### Catalog# Description Size

PM-9323	Plastice Tray, small with silicone mat	2-3/4" x 1-3/4" x 3/4" (73 mm x 44 mm x 19 mm)
---------	--	---



PM-9323



## Brown Nasal Splint (12/Pkg)

Catalog#	Description	Size
PM-360	X-Large, with Forehead Extensions	114 mm x 70 mm
PM-361	Large, without Forehead Extensions	70 mm x 60 mm
PM-362	Medium, without Forehead Extensions	70 mm x 48 mm
PM-363	Small, without Forehead Extensions	54 mm x 48 mm
PM-460	X-Large, Felt Splint with Forehead Extensions	114 mm x 70 mm
PM-461	Large Felt Splint without Forehead Extensions	70 mm x 60 mm
PM-462	Medium Felt Splint without Forehead Extensions	70 mm x 48 mm
PM-463	Small Felt Splint without Forehead Extensions	54 mm x 48 mm

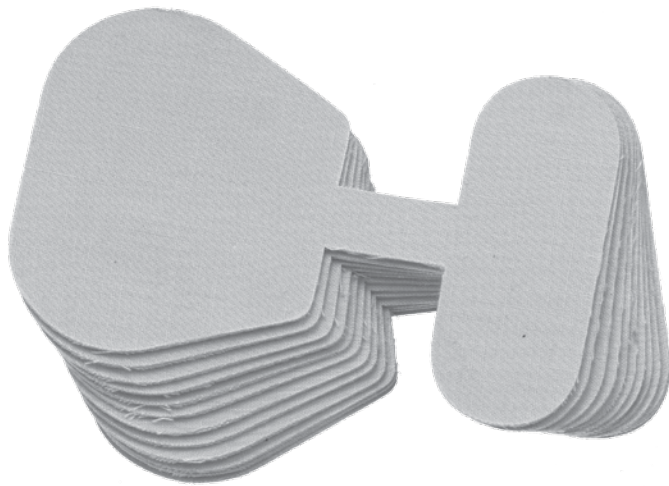

PM-360



PM-361

## Nasostat® Treatment of Epistaxis

- Nasostat® products may be used in conjunction with anterior packing
- Will control bleeding while minimizing patient discomfort associated with nasal packs
- A safe and easily tolerated alternative to other treatments for epistaxis, e.g. cautery
- Sterile, 1-year shelf life

Catalog#	Description	Qty
41900*	Nasostat Regular, Sterile	5/Bx
41901*	Nasostat Slimline, Sterile	5/Bx
41902*	Nasostat Large, Sterile	5/Bx
41903*	Nasostat Small, Sterile	5/Bx

\*Miltex® Brand



41900

## ENT Packing Line

The Miltex® ENT Packing line is a full offering of Polyvinyl Alcohol dressings for nasal, sinus and ear surgeries. The soft pre-compressed micro-pore size material allows for quick insertion and atraumatic removal for patient comfort. The Miltex® ENT Packing line is 100% lint and fiber free, easily trimmed for a custom fit and most products are available with a drawstring for patient safety.

### Features

- Hydrophilic and fast wicking
- Absorbs up to 25 times its weight in fluid
- Supplied compressed for easier insertion
- Disposable, one-time use only
- Sterile, 4-year shelf life

## Ear Packing

- Excellent wicking capabilities for administering otic medication in the treatment of Swimmer's Ear and other post-otic surgery.
- Fits into swollen ear canal and continually expands during healing process; helps provide contact and medication delivery to the infection site.

Catalog#	Description
----------	-------------

19-2000*	Short Otitis Externa Wick (9 mm x 15 mm), (1/pkt - 50 pkts/box)
19-2002*	Long Otitis Externa Wick (9 mm x 24 mm), (1/pkt - 10 pkts/box)
19-2004*	Ear Packing w/ String, (12 mm x 15 mm), (1/pkt - 10 pkts/box)



19-2000



19-2002



19-2004

\*Miltex® Brand

## Epistaxis

- Highly absorbent and effective control of epistaxis
- Inserts in seconds vs. traditional gauze packing method requiring 4 to 6 feet of gauze.
- Removal is easy and atraumatic.

Catalog#	Description
----------	-------------

20-3020*	Small Epistaxis Dressing w/ String, (55 mm x 15 mm x 25 mm), (1/pkt - 20 pkts/box)
20-3022*	Large Epistaxis Dressing w/ String, (100 mm x 15 mm x 25 mm), (1/pkt - 10 pkts/box)



20-3020



20-3022

\*Miltex® Brand

## Nasal

- Nasal products can be used for absorption and drainage for Rhinoplasty, Septoplasty and other nasal post-operative procedures.
- Non-stick skinned surface on dressing helps with atraumatic removal and minimizes re-bleeding.
- Dressings with airway (cannulated) tubes help ensure patient comfort.

Catalog#	Description
----------	-------------

20-3000*	Small Standard Nasal Dressing w/ String (45 mm x 15 mm x 20 mm), (1/pkt - 10 pkts/box)
20-3002*	Small Standard Nasal Dressing with Airway Tube and String (45 mm x 15 mm x 20 mm), (1/pkt - 10 pkts/box)
20-3004*	Large Standard Nasal Dressing w/ String (80 mm x 15 mm x 20 mm), (1/pkt - 10 pkts/box)
20-3006*	Large Standard Nasal Dressing with Airway Tube and String (80 mm x 15 mm x 20 mm), (1/pkt - 10 pkts/box)
20-3010*	Thin Anatomical Nasal Dressing w/ String (80 mm x 7.5 mm x 30 mm), (1/pkt - 10 pkts/box)
20-3012*	Standard Anatomical Nasal Dressing w/ String (80 mm x 15 mm x 30 mm), (1/pkt - 10 pkts/box)
20-3014*	Standard Anatomical Nasal Dressing with Airway Tube and String (80 mm x 15 mm x 30 mm), (1/pkt - 10 pkts/box)

\*Miltex® Brand



20-3000



20-3002



20-3004



20-3006



20-3010



20-3012



20-3014

## Sinus

- Designed to prevent lateralization of the middle turbinate after Functional Endoscopic Sinus Surgery.
- Compressed configuration for easy small cavity placement.
- Absorbs post-operative drainage and helps clear clots and debris upon removal, leaving a clean cavity.

Catalog#	Description
20-3030*	Sinus Dressing B-Type w/ String (25 mm x 9 mm x 20 mm), (2/pkt - 10 pkts/box)
20-3032*	Sinus Dressing K-Type w/ String (35 mm x 9 mm x 12 mm), (2/pkt - 10 pkts/box)
20-3034*	Sinus Dressing T-Type w/ String (45 mm x 9 mm x 20 mm), (2/pkt - 10 pkts/box)
20-3036*	Slim Sinus Dressing B-Type w/ String (25 mm x 6 mm x 20 mm), (2/pkt - 10 pkts/box)
20-3038*	Slim Sinus Dressing K-Type w/ String (35 mm x 6 mm x 12 mm), (2/pkt - 10 pkts/box)
20-3040*	Slim Sinus Dressing T-Type w/ String (45 mm x 6 mm x 12 mm), (2/pkt - 10 pkts/box)
20-3042*	Sinus Dressing Kit - Assortment of Sinus Dressing, Nasal Dressing/Airway Tube, (1/pkt - 10 pkts/box)

\*Miltex® Brand



20-3030



20-3032

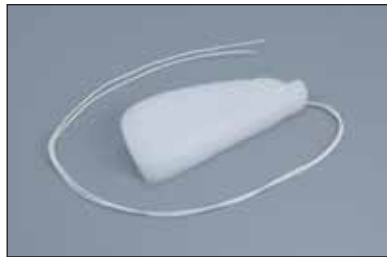

20-3034



20-3036



20-3038



20-3040



20-3042

## Polk Finger Goniometer

Measures finger extension post hand surgery.

Catalog#	Description	Length
27-144*	Graduated in Inches and Centimeters	6" (152 mm)

\*Miltex® Brand

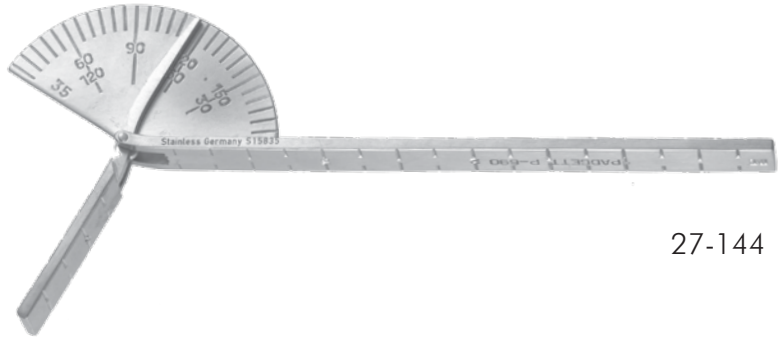

27-144

## DeMayo Two-Point Discrimination Device

Post hand surgery diagnostic.

Catalog#
PM-855

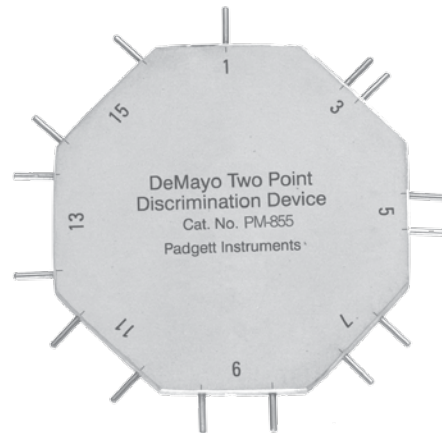

PM-855

## Surgical Hand Table

Catalog#	Description	Size
PM-740	Aluminum, Satin Finish	8" x 6-1/4" (203 mm x 159 mm)

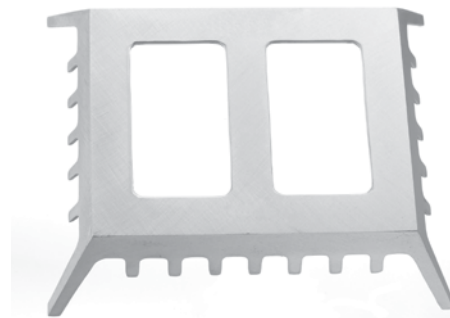

PM-740

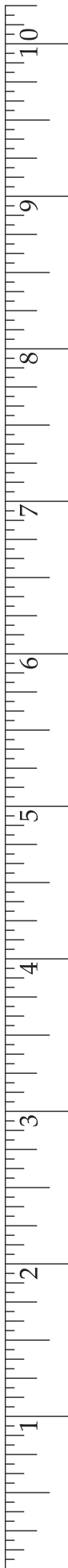

## Coated Aluminum Orthopedic Hand

Catalog#	Description	Length	Width
PM-962	Coated Aluminum Orthopedic Hand, Reusable, Large	9-1/2" (241 mm)	8-1/2" (216 mm)
PM-963	Coated Aluminum Orthopedic Hand, Reusable, X-Large	13" (330 mm)	10-1/2" (267 mm)

Coated Aluminum Orthopedic Hands are ideal for reconstructive hand surgery and provide an environmentally safe alternative to traditional lead hands and splints. Orthopedic Hands are made of pliable aluminum with a non-latex coating and are reusable and easy to sterilize. In addition, Aluminum Hands may be used during x-ray and fluoroscopy procedures.



PM-962, Large



PM-963, X-Large

## Hand Fixation Device

Catalog#	Description	Length	Width
PM-961	Hand Fixation Device	11-1/2" (292 mm)	9-1/8" (232 mm)

The Hand Fixation Device is ideal for both right and left hand procedures. Manufactured from high quality medical grade German stainless steel and PEEK material on the finger restraints.

- *Fixation of single joints from carpus to fingertips*
- *No slipping or escaping of single joints*
- *Adjustable finger and wrist restraints make the hand fixation device convenient for use on a variety of patients*
- *V2A antimagnetic high-grade steel*
- *Fully autoclavable*



PM-961



### Brueckmann Orthopedic Hand, Lead

Catalog#	Description	Length	Width
PM-710	Reusable	10-3/4" (273 mm)	9-1/2" (241 mm)

\* Sterilize separately from other instruments and materials



PM-710

### Framer Hand Shaped Splint, Lead

Catalog#	Description	Length	Width
PM-4480	Adult, Standard Size	14-5/8" (372 mm)	10" (254 mm)
PM-4835	Infant Size	10-1/4" (260 mm)	7" (178 mm)

\* Sterilize separately from other instruments and materials



PM-4480

## Bunnell Bone Drill

Catalog#	Description
----------	-------------

27-180*	Small Type, with Three Chucks for Wires and Burrs
---------	---

- Lightweight, Chrome Plated, with 5/32" (4 mm) Capacity Stainless Steel Jacobs Chuck
- Cannulated for use with Kirschner wires and thin drills.
- Chuck Key stores inside handle

\*Miltex® Brand

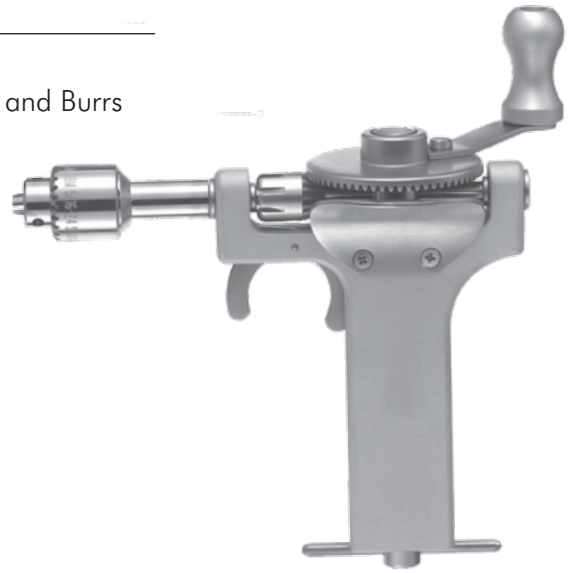

27-180

## Fascia Stripper

Catalog#	Tip Diameter	Length
----------	--------------	--------

PM-1684	10 mm (ID)	13-1/4" (337 mm)
---------	------------	------------------



PM-1684

## Fascia Cutter

Catalog#	Tip Diameter	Length
----------	--------------	--------

PM-1686	10 mm (ID)	13-1/4" (337 mm)
---------	------------	------------------



PM-1686



### Brand Tendon Stripper

Catalog#	Description	Length	Width
PM-1688	Plantaris	18" (457 mm)	6 mm (ID)
PM-210	Palmaris	12" (305 mm)	3 mm (ID)
PM-4472	Tendon, Rectangular	20" (508 mm)	16 mm x 9 mm



### Furlong Tendon Stripper

Catalog#	Length	Width
PM-1690-4	8" (203 mm)	4 mm
PM-1690-5	8" (203 mm)	5 mm



### Bunnell Tendon Stripper

Catalog#	Description	Length	Inner Diameter
27-1020*	Size 2	6" (152 mm)	3 mm
27-1022*	Size 1	6" (152 mm)	4 mm
27-1024*	Size 2	6" (152 mm)	5 mm
27-1026*	Size 3	6" (152 mm)	6 mm
27-1028*	Size 4	6" (152 mm)	7 mm
PM-4565	Size 5	6" (152 mm)	8 mm



\*Miltex® Brand

### Unna Comedone Extractor

Catalog#	Description	Length
----------	-------------	--------

33-210*	Spoon Ends	5-3/4" (146 mm)
---------	------------	-----------------



\*Miltex® Brand

33-210

### Hallack Comedone Extractor

Catalog#	Description	Length	Width
----------	-------------	--------	-------

PM-4446	Double-Ended with Protective Sheath for Acne Lance	6" (152 mm)	5 mm
---------	--	-------------	------

33-214*	Double-Ended with Protective Sheath for Acne Lance	6" (152 mm)	5 mm
---------	--	-------------	------



\*Miltex® Brand

PM-4446

### Greg Comedone Extractor

Catalog#	Description	Length	Width
----------	-------------	--------	-------

33-215*	Fenestrated Cup, Chuck with Interchangeable No. 65 Lancet Blade, Protected by Cap	5" (127 mm)	5 mm
---------	---	-------------	------



\*Miltex® Brand

33-215

### Schamberg Comedone Extractor, Double-Ended

Catalog#	Description	Length
33-201*	With Crimped Small Loop	3-3/4" (95 mm)
33-202*	With Extra-Fine Loops & Small Loop Crimped	3-3/4" (95 mm)
33-200*	With Square Loop Ends	3-3/4" (95 mm)



33-201



33-202

\*Miltex® Brand



33-200

### Saalfeld Comedone Extractor

Catalog#	Description	Length
33-206*	With Acne Lancet	4-1/4" (108 mm)
33-204*	With Acne Lancet	5-3/4" (146 mm)



\*Miltex® Brand

33-204

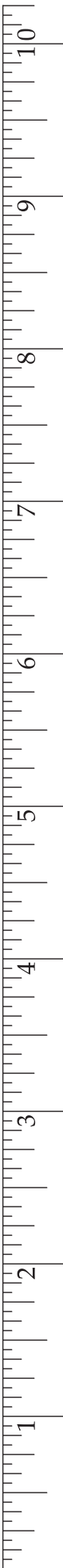

## Keys Dermal Punch

See Disposable Section for sterile disposable biopsy punches on page 320.

Catalog#	Description	Length
33-20*	2 mm	4" (102 mm)
33-22*	3 mm	4" (102 mm)
33-24*	4 mm	4" (102 mm)
33-25*	5 mm	4" (102 mm)
33-26*	6 mm	4" (102 mm)
33-28*	8 mm	4" (102 mm)

\*Miltex® Brand



33-22

## Keys Dermal Punch Set

Catalog#	Description	Length
33-30*	Handle with screw-in Keys Knives 2, 3, 4, 5, 6 and 7 mm mounted on storage and sterilization rack	3-1/2" (89 mm)
33-30-1*	Handle	
33-30-2*	2 mm head	
33-30-3*	3 mm head	
33-30-4*	4 mm head	
33-30-5*	5 mm head	
33-30-6*	6 mm head	
33-30-7*	7 mm head	



\*Miltex® Brand

33-30

# SUCTION



### Magill Suction Tube

Catalog#	Description	Size	Length
PM-0732-1	Stainless Steel	1	9" (229 mm)
PM-0732-2	Stainless Steel	2	9" (229 mm)
PM-0732-3	Stainless Steel	3	9" (229 mm)



PM-0732-2

### Killian (VonEicken) Antrum Cannula

Catalog#	Description	Diameter	Length
20-456*	Bulbous Tip, Center Opening, Sterling	2.5 mm	5-3/4" (146 mm)

\*Miltex® Brand



20-456

### Frazier (Ferguson) Suction Tube, With Finger Cut-Off

Catalog#	Description	Diameter	Length
19-570*	Angled	6 Fr (2 mm)	7" (178 mm)
19-572*	Angled	7 Fr (2.3 mm)	7" (178 mm)
19-573*	Angled	8 Fr (2.6 mm)	7" (178 mm)
19-574*	Angled	9 Fr (3 mm)	7" (178 mm)
19-575*	Angled	10 Fr (3.3 mm)	7" (178 mm)
19-576*	Angled	11 Fr (3.6 mm)	7" (178 mm)
19-577*	Angled	12 Fr (4 mm)	7" (178 mm)

\*Miltex® Brand

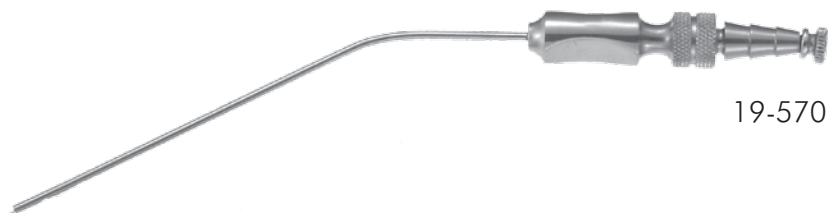

19-570

### Yankauer Suction Tube

Catalog#	Description	Length
2-104SS*	Stainless Steel with Removable Tip	11-3/4" (298 mm)
2-106SS*	Replacement Tip	

\*Miltex® Brand

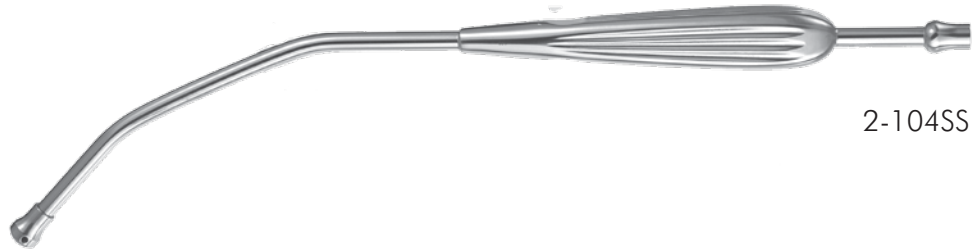

2-104SS

### Rosen Suction Tube, 6 cm working length, includes stylet

Catalog #	Size
19-530*	14 gauge (2.1 mm)
19-531*	15 gauge (1.8 mm)
19-532*	16 gauge (1.6 mm)
19-533*	17 gauge (1.4 mm)
19-534*	18 gauge (1.2 mm)
19-535*	19 gauge (1.0 mm)
19-536*	20 gauge (0.9 mm)
19-537*	22 gauge (0.7 mm)
19-538*	24 gauge (0.55 mm)
19-539*	26 gauge (0.45 mm)

\*Miltex® Brand

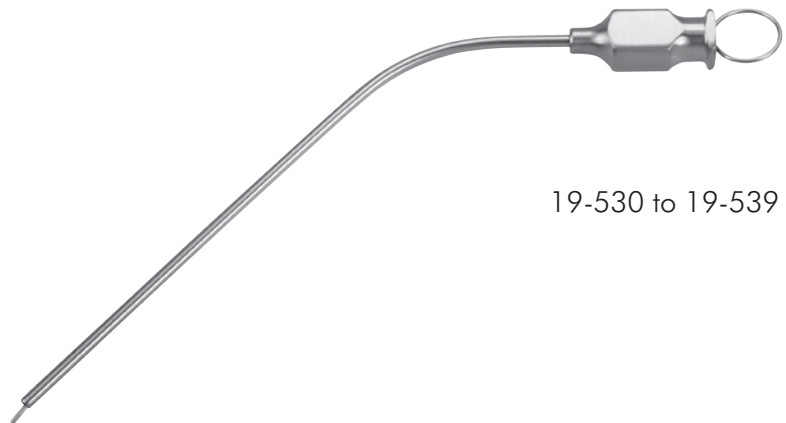

19-530 to 19-539

### House Cut-off Adapter, for use with Rosen Suction Tubes

Catalog#	Description
19-540*	4 mm diameter tubing end, stainless steel
19-541*	4 mm diameter tubing end, chrome

\*Miltex® Brand



19-540



19-541

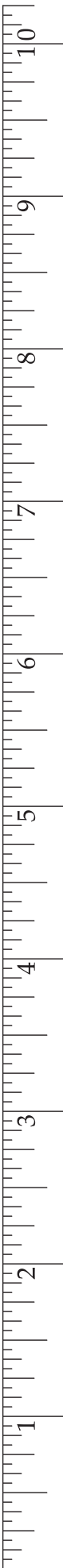

### William-House Suction - Irrigation Tubes with Thumb Plate and Cut-Off

Catalog #	Size	Working Length
19-550*	2 x 2.5 Fr	8.5 cm
19-551*	2.5 x 4 Fr	7.0 cm
19-552*	2.5 x 4 Fr	9.5 cm
19-553*	4 x 5 Fr	7.0 cm
19-554*	5 x 7 Fr	9.5 cm
19-555*	4 x 5 Fr	9.5 cm
19-557*	7 x 10 Fr	9.5 cm
19-558*	8 x 12 Fr	9.5 cm
19-559*	12 x 14 Fr	9.5 cm
19-562*	5 x 5 Fr	9.5 cm
19-563*	6 x 8 Fr	9.5 cm
19-564*	6 x 9 Fr	9.5 cm
19-565*	6 x 14 Fr	9.5 cm



19-563

\*Miltex® Brand

### Schuknecht Suction Tubes with Thumb Plate and Cut-Off

Catalog#	Size	Working Length
19-585*	20 gauge	7.8 cm
19-586*	24 gauge	7.8 cm

\*Miltex® Brand



19-586



# PIN AND WIRE INSTRUMENTS



**Suture Wire, 4 oz. (118g) Spool for Intraoral Fixation**

Catalog#	Description	Gauge
9-44-18*	Soft (.040") (1 mm)	18
9-44-20*	Soft (.032") (.8 mm)	20
9-44-22*	Soft (.025") (.6 mm)	22
9-44-24*	Soft (.020") (.5 mm)	24
9-44-25*	Soft (.018") (.45 mm)	25
9-44-26*	Soft (.016") (.40 mm)	26
9-44-28*	Soft (.012") (.3 mm)	28
9-44-30*	Soft (.010") (.25 mm)	30
9-44-32*	Soft (.008") (.2 mm)	32
9-44-34*	Soft (.006") (.15 mm)	30



9-44-18

\*Miltex® Brand

**Erich Arch Bar Material**

Catalog#	Description
PM-670	One Meter Roll



PM-670

**Meade Wire Cutting Pliers, Tungsten Carbide**

Catalog#	Length
PM-4137	9-1/2" (241 mm)

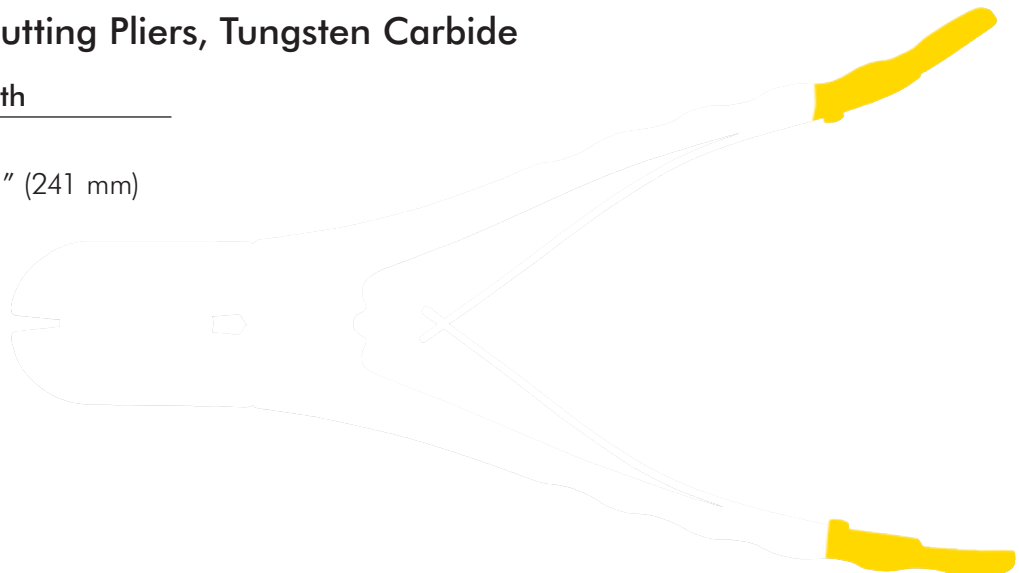

PM-4137



### Pin & Wire Cutter, Tungsten Carbide

Catalog#	Description	Length
----------	-------------	--------

27-159TC*	Double Action, cuts up to 2 mm (5/64") soft wire or 1.5 mm (1/16") hard wire	7" (178 mm)
-----------	--	-------------

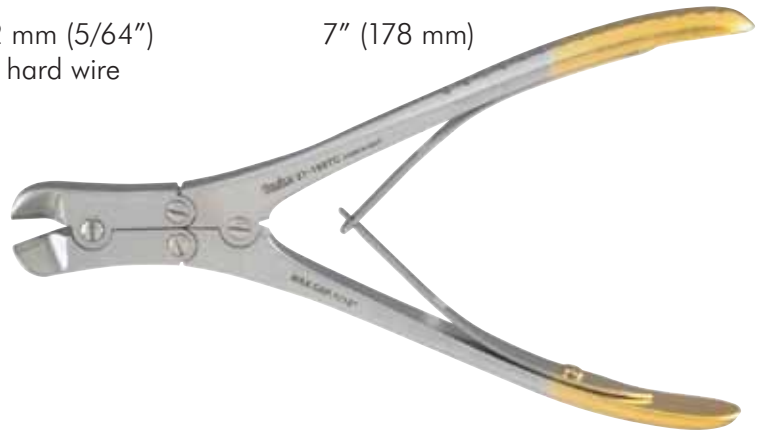

27-159TC

\*Miltex® Brand

### Pin Cutter, Tungsten Carbide, Heavy Duty

Catalog#	Description	Length
----------	-------------	--------

27-161TC*	Double Action, cuts up to 4.8 mm (3/16") diameter	15" (382 mm)
-----------	---	--------------



27-161TC

\*Miltex® Brand

### Front/Side Pin & Wire Cutter, Tungsten Carbide

Catalog#	Description	Length
----------	-------------	--------

27-163TC*	Double Action, Flush Cutting, cuts up to 2 mm (5/64") soft wire or 1.6 mm (1/16") hard wire	7" (178 mm)
-----------	---	-------------

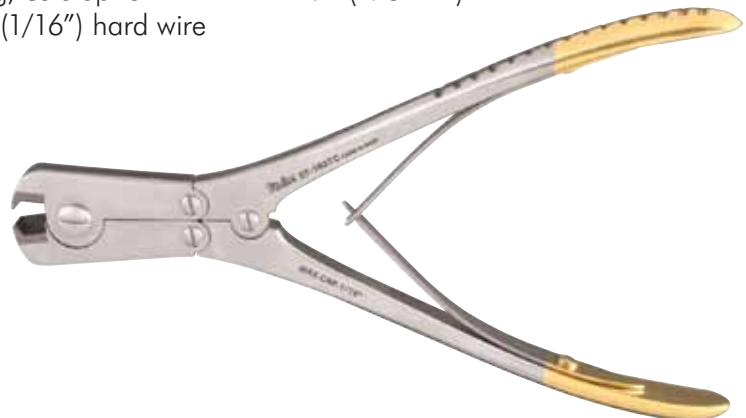

27-163TC

\*Miltex® Brand

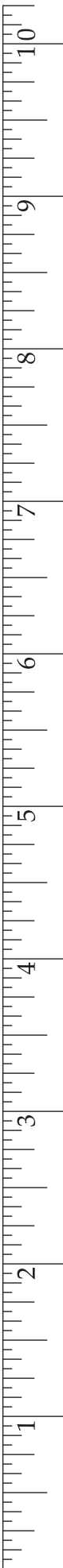

### Pin & Wire Puller, Tungsten Carbide

Catalog#	Description	Length
27-164TC*	Double Action, 4 mm wide jaws	7" (178 mm)
27-165TC*	Double Action, 6 mm wide jaws	7" (178 mm)



27-164TC



27-165TC



27-164TC

\*Miltex® Brand

### Pin Puller, Tungsten Carbide

Catalog#	Description	Length
27-176TC*	1 cm length serrated top jaw & 1 cm length grooved opposing jaw	5-1/2" (140 mm)



27-176TC

\*Miltex® Brand

### Wire Twister, Tungsten Carbide

Catalog#	Description	Length	Jaw Width
----------	-------------	--------	-----------

22-500TC*	Heavy Serrated Jaws	6" (152 mm)	4 mm
22-502TC*	Heavy Serrated Jaws	8" (203 mm)	3 mm

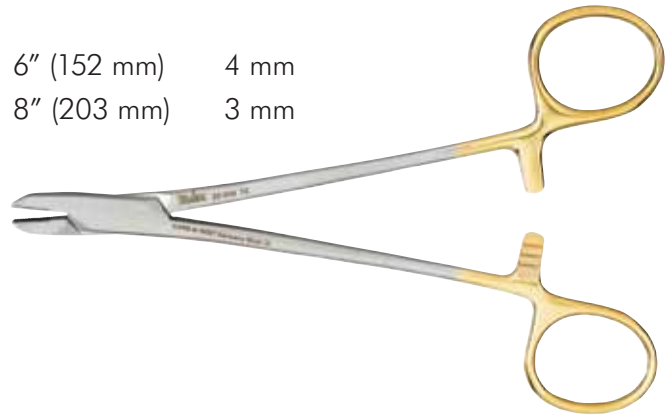

22-500TC

\*Miltex® Brand

### Carroll Wire Twister, Tungsten Carbide

Catalog#	Description	Length	Jaw Width
----------	-------------	--------	-----------

PM-2121	Heavy Serrated Jaws, Delicate	6" (152 mm)	3 mm
PM-2122	Heavy Serrated Jaws, Blunt	6" (152 mm)	4 mm



PM-2121

### Corwin Wire Twister, Tungsten Carbide

Catalog#	Description	Length
----------	-------------	--------

PM-2123	Serrated Jaws	6" (152 mm)
---------	---------------	-------------



PM-2123

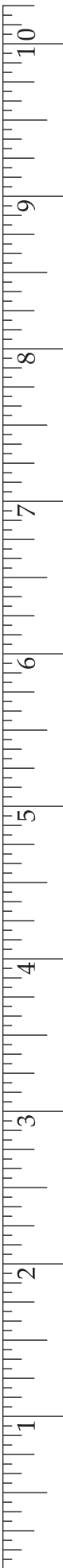

### Suture Wire Cutting Scissors (TC)

Catalog#	Description	Length
----------	-------------	--------

9-124TC*	Angled to Side, 1 Serrated Blade	4-3/4" (121 mm)
----------	----------------------------------	-----------------

\*Miltex® Brand

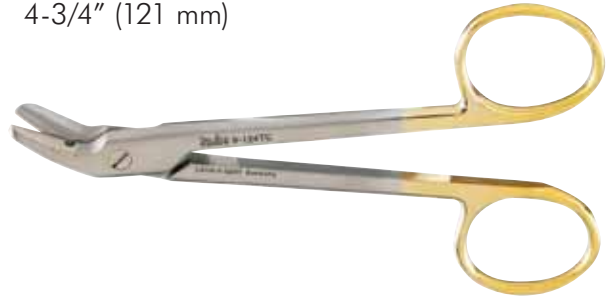

9-124TC

### Costa Wire/Suture Scissors

Catalog#	Description	Length
----------	-------------	--------

9-124*	Angled to Side, 1 Serrated Blade	4-3/4" (121 mm)
--------	----------------------------------	-----------------

\*Miltex® Brand

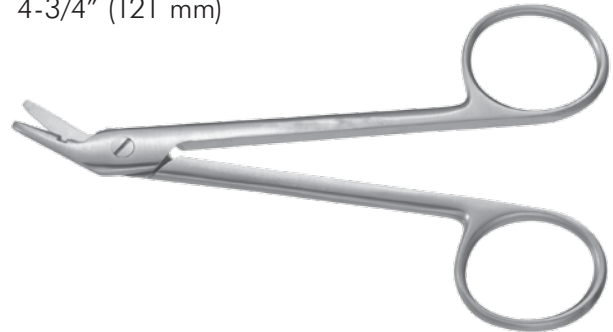

9-124

### Padgett Pliers

Ideal for handling pins, wire, plates and general utility

Catalog#	Description	Length
----------	-------------	--------

PM-3875	Stainless Steel	7-3/4" (197 mm)
---------	-----------------	-----------------



PM-3875

### Wire Bending Pliers

Catalog#	Description	Length
----------	-------------	--------

74-10*	Knotched Jaws	5" (127 mm)
--------	---------------	-------------

\*Miltex® Brand



74-10

### Reynolds Wire Forming Pliers

Catalog#	Description	Length
----------	-------------	--------

74-35*	Curved Jaws	5-1/4" (133 mm)
--------	-------------	-----------------

\*Miltex® Brand



74-35

### Peeso Pliers

Catalog#	Description	Length
----------	-------------	--------

74-40*	Tapered Jaws	5" (127 mm)
--------	--------------	-------------

\*Miltex® Brand



74-40

### Lab & Office Pliers

Catalog#	Description	Length
----------	-------------	--------

74-45*	Long Narrow Jaws	5-3/4" (146 mm)
--------	------------------	-----------------

\*Miltex® Brand



74-45

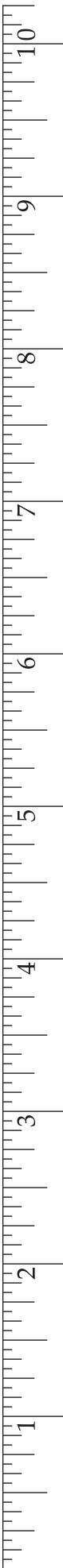

### Bird Beak Wire Forming Pliers

Catalog#	Description	Length
----------	-------------	--------

74-55*	Loop forming pliers for round wire up to .030" (.76 mm)	4-3/4" (121 mm)
--------	---	-----------------



74-55

\*Miltex® Brand

### Three Jaw Wire Forming Pliers

Catalog#	Description	Length
----------	-------------	--------

74-75*	For bending and contouring wire up to .030" (.76 mm)	4-3/4" (121 mm)
--------	--	-----------------



74-75

\*Miltex® Brand

### Jarabak Wire Forming Pliers

Catalog#	Description	Length
----------	-------------	--------

74-301*	For light wire bending; Grooves assist with precise bending and closing of loops. Serrated surface grips wire up to .02" (.51 mm)	5" (127 mm)
---------	---	-------------



74-301

\*Miltex® Brand

### Omega Loop Forming Pliers

Catalog#	Description	Length
----------	-------------	--------

74-303*	U Graduated cone .045", .060" and .075" (1.14 mm, 1.52 mm, 1.91 mm); For forming precise omega loops	5" (127 mm)
---------	--	-------------



74-303

\*Miltex® Brand



### Light Wire Bird Beak Pliers with Groove

Catalog#	Description	Length
74-305*	For forming precise loops in light wires up to .020" (.51 mm). The groove in the tip allows for duplicating loops	5" (127 mm)

\*Miltex® Brand



74-305

### Tweed Loop Forming Pliers

Catalog#	Description	Length
74-306*	Loop forming pliers with .045", .60" and .075" (1.14 mm, 1.52 mm, 1.91 mm); For creating bull and helical loops in wires up to .022" x .028" (.56 mm x .71 mm)	4-3/4" (121 mm)

\*Miltex® Brand



74-306

### Arch Bending Pliers

Catalog#	Description	Length
74-307*	For placing first, second and third order bends; .050" (1.27 mm) blade width	4-3/4" (121 mm)

\*Miltex® Brand

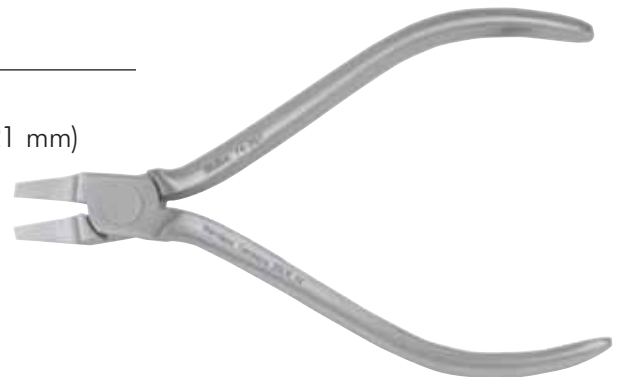

74-307

### Rectangular Arch Bending Pliers

Catalog#	Description	Length
74-308*	For placing first, second and third order bends; .070" (1.78 mm) blade width	4-3/4" (121 mm)

\*Miltex® Brand

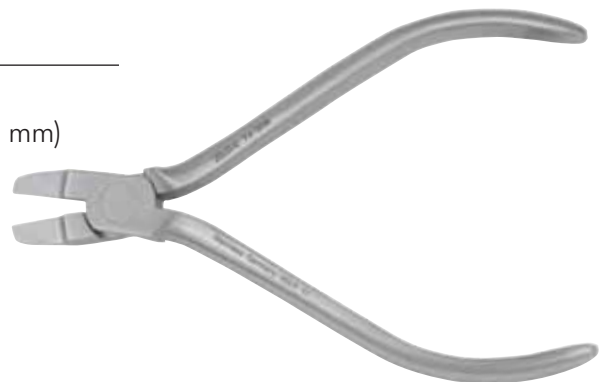

74-308

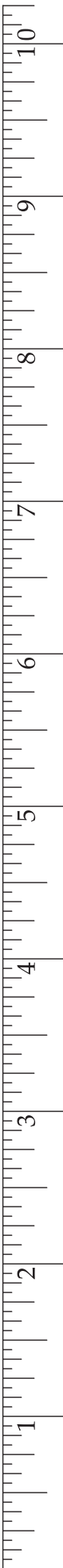



### Lingual Arch Forming Pliers

Catalog#	Description	Length
----------	-------------	--------

74-309\* To create double back and triple back bends in .030" & .036" lingual arch wires

4-1/2" (114 mm)



74-309

\*Miltex® Brand

### Hollow Chop Contouring Pliers

Catalog#	Description	Length
----------	-------------	--------

74-310\* For subtle contouring of arch wire of all sizes

4-3/4" (121 mm)



74-310

\*Miltex® Brand

### O'Brien Wire Forming Pliers

Catalog#	Description	Length
----------	-------------	--------

74-311\* For forming small helical loops and intraoral tip back bends

4-3/4" (121 mm)



74-311

\*Miltex® Brand

### Mini Three Jaw Wire Forming Pliers

Catalog#	Description	Length
----------	-------------	--------

74-312\* Rounded tips ease contouring of light wires

4-1/2" (114 mm)



74-312

\*Miltex® Brand

### Marcotte Looping Pliers

Catalog#	Description	Length
----------	-------------	--------

74-316*	For forming helical loops and "T" loops	5" (127 mm)
---------	---	-------------

\*Miltex® Brand



74-316

### Hollow Chop Wire Forming Pliers

Catalog#	Description	Length
----------	-------------	--------

74-317*	For subtle contouring of arch wire of all sizes	4-3/4" (121 mm)
---------	---	-----------------

\*Miltex® Brand



74-317

### Light Wire Bird Beak Pliers

Catalog#	Description	Length
----------	-------------	--------

74-318*	For forming precise loops in light wires up to .020" (.51 mm)	5" (127 mm)
---------	---	-------------

\*Miltex® Brand



74-318

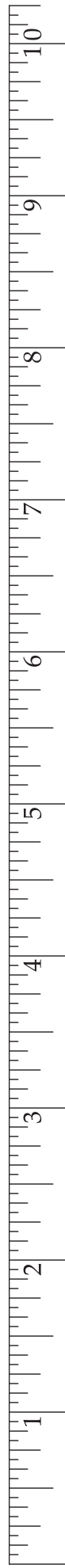

### Nance Wire Forming Pliers

Catalog#	Description	Length
74-319*	For forming loops in four lengths - 3, 4, 5 and 6 mm; Groove at base aids in closing loops. Wire capacity .022"	4-3/4" (121 mm)

\*Miltex® Brand

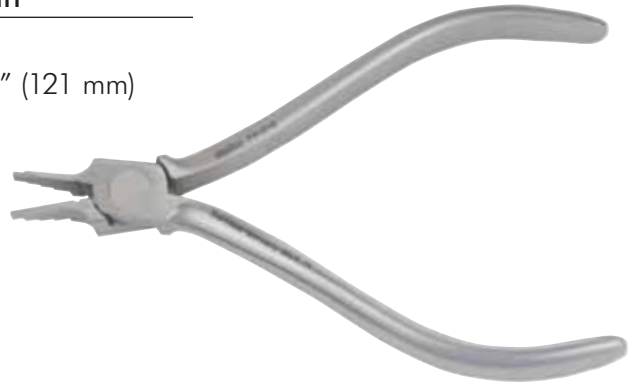

74-319

### Adams Wire Forming Pliers

Catalog#	Description	Length
74-320*	For right angle bends and appliance adaptation; Wires up to .040"	4-1/2" (114 mm)

\*Miltex® Brand



74-320

### V-Stop Wire Forming Pliers

Catalog#	Description	Length
74-321*	For placing V bend in archwires to prevent archwire from traveling	4-3/4" (121 mm)

\*Miltex® Brand



74-321



### Three Prong NiTi Bender Pliers

Catalog#	Description	Length
74-322*	For forming and contouring archwire, especially nickel titanium wire up to .02"	4-1/2" (114 mm)

\*Miltex® Brand



74-322

### Old Style Looping Pliers

Catalog#	Description	Length
74-324*	For forming and closing loops with one cylindrical three-step beak and one triangular beak	4-3/4" (121 mm)

\*Miltex® Brand



74-324

### Mathieu Wire Forming Pliers

Catalog#	Description	Length
74-330*	For ligature tying and placing of elastics, 2.1 mm jaw	5-1/2" (140 mm)

\*Miltex® Brand

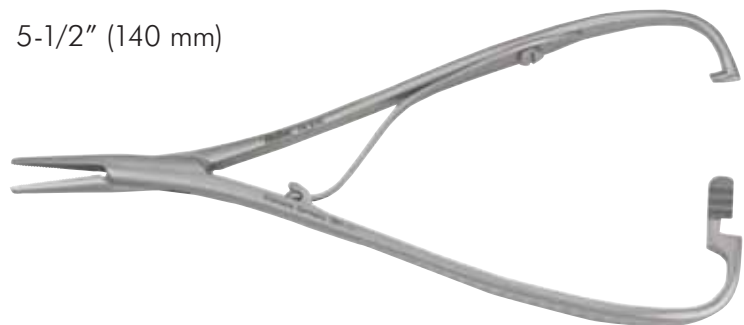

74-330



# MEASURING AND MARKING INSTRUMENTS



### Thorpe Caliper

Catalog#	Description	Length
----------	-------------	--------

18-657*	Angled, Graduated in Inches and Millimeters	4-1/2" (114 mm)
---------	---	-----------------

\*Miltex® Brand



18-657

### Jameson Caliper

Catalog#	Description	Length
----------	-------------	--------

18-658*	Graduated in Inches and Millimeters	3-3/4" (95 mm)
---------	-------------------------------------	----------------

\*Miltex® Brand



18-658

### Ruler

Catalog#	Description	Length
----------	-------------	--------

PM-0676	Graduated in Millimeters and Inches with Clip	6" (152 mm)
18-660*	Graduated in Millimeters and Inches without Clip	6" (152 mm)
PM-0678	Graduated in Millimeters and Inches with Clip	12" (305 mm)

\*Miltex® Brand



18-660



PM-0676

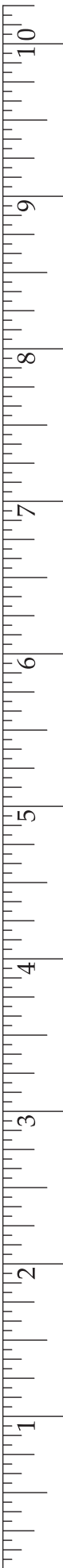

## Ginsberg Caliper

Catalog#	Description	Length
----------	-------------	--------

Combination measuring and marking calipers

PM-4244	Scale Reads 0 to 40 mm	6-3/4" (171 mm)
---------	------------------------	-----------------



PM-4244

## Castroviejo Caliper

Catalog#	Description	Length
----------	-------------	--------

18-650*	Scale Reads 0 to 20 mm	3-1/4" (83 mm)
68-699*	Scale Reads 0 to 40 mm	3-1/2" (89 mm)



18-650



68-699

\*Miltex® Brand



### Micro Boley Gauge

Catalog#	Description	Length
----------	-------------	--------

68-697*	Stainless Steel	5" (127 mm)
---------	-----------------	-------------

\*Miltex® Brand

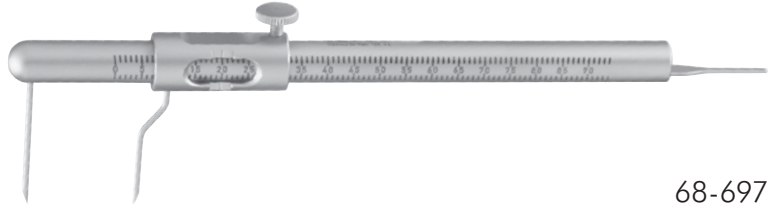

68-697

Slender tips allow for accurate measurements.

### Boley Gauge

Catalog#	Description	Length
----------	-------------	--------

68-694*	Stainless Steel	5-1/2" (140 mm)
---------	-----------------	-----------------

\*Miltex® Brand

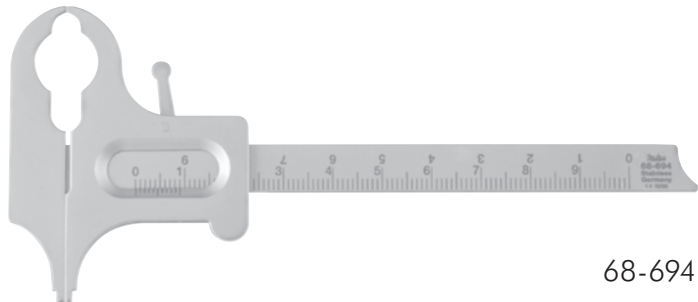

68-694

### Spring Bow Dividers

Catalog#	Description
----------	-------------

68-695*	4-1/2" (114 mm) radius
---------	------------------------

68-696*	6" (152 mm) radius
---------	--------------------

\*Miltex® Brand



68-695



68-696

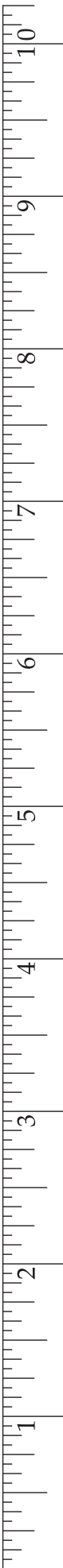

## Polk Finger Goniometer

Measures finger extension post hand surgery.

Catalog#	Description	Length
27-144*	Graduated in Inches and Centimeters	6" (152 mm)

\*Miltex® Brand

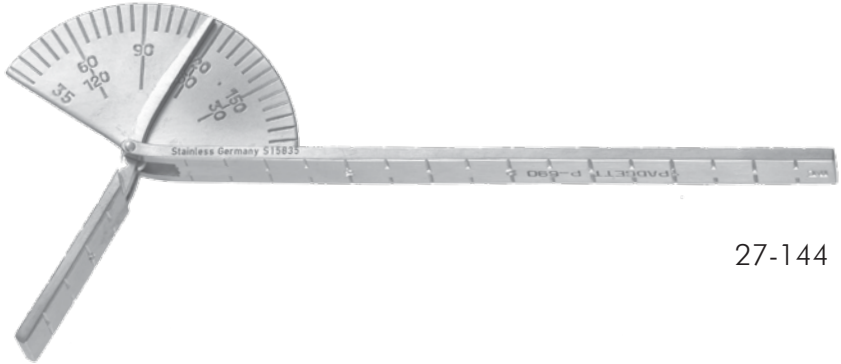

27-144

## DeMayo Two-Point Discrimination Device

Post hand surgery diagnostic.

**Catalog#**

PM-855

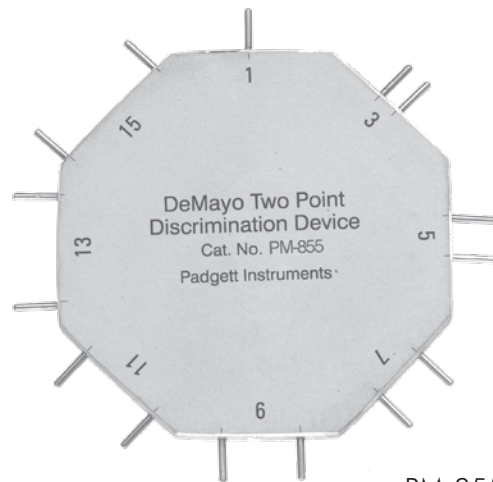

PM-855

### Skin Marking Pen

Catalog#	Description	Length
PM-0688	Reversible Holder for Point, Stainless Steel	5" (127 mm)
PM-0690	Spare Tips for PM-0688, 12/PKG	



### Cronin Ink Well

Catalog#	Description
PM-398	Stainless Steel



### Sheen Grid

Catalog#	Description
PM-3755	Aluminum, Black on Silver
PM-3756	Aluminum, Silver on Black

Ideal for cutting, measuring and photographing cartilage grafts. Graduated in mm with bold cm markings.

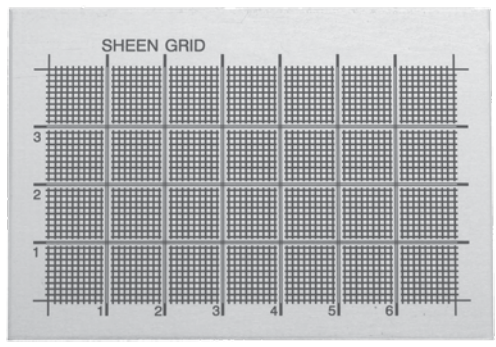

PM-3755

### Grossman Areola Marker, Aluminum

Catalog#	Description
----------	-------------

PM-454	4 Sizes - 40 mm, 44 mm, 48 mm, 52 mm
--------	--------------------------------------



PM-454

### Chang Areola Marker, Aluminum

Catalog#	Description
----------	-------------

PM-470	With Quadrant Markers, Aluminum, Sizes 38 & 52 mm
--------	---



PM-470

### Freeman Areola Marker, Stainless Steel

Catalog#	Diameter
----------	----------

PM-468	34 mm
PM-469	36 mm
PM-464	38 mm
PM-465	42 mm
PM-467	45 mm
PM-466	50 mm
21-734*	34 mm, Improved Pattern
21-736*	36 mm, Improved Pattern
21-738*	38 mm, Improved Pattern
21-742*	42 mm, Improved Pattern
21-745*	45 mm, Improved Pattern
21-750*	50 mm, Improved Pattern



PM-464

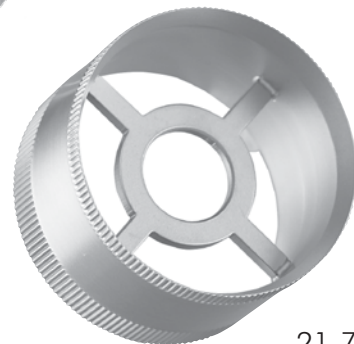

21-738

\*Miltex® Brand



## McKissock Mammoplasty Caliper

For symmetrical repositioning of areola by using mid-clavicular reference point. Tongs lock into position to prevent accidental slippage.

Catalog#	Description	Length
PM-8750	Graduated in mm and inches	11-1/4" (286 mm)

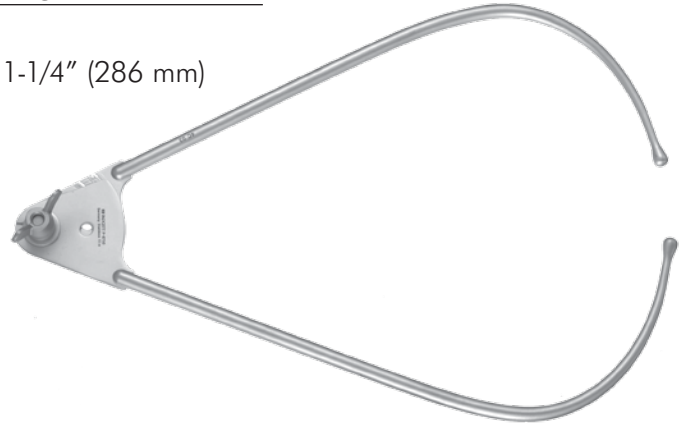

PM-8750

## McKissock Keyhole Pattern

Catalog#	Description	Diameter
PM-4944	With cm Marks	38 mm
PM-4945	With cm Marks	42 mm
PM-4946	With cm Marks	45 mm
21-838*	With cm Marks	38 mm
21-842*	With cm Marks	42 mm
21-845*	With cm Marks	45 mm

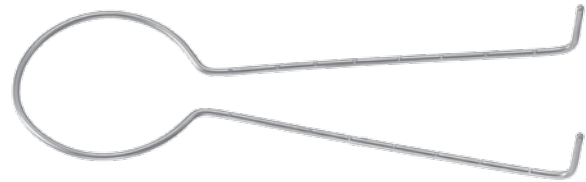

PM-4944 and 21-838

\*Miltex® Brand

## Halpern Breast Marker

Catalog#	Diameter
PM-9312	38 mm
PM-9313	42 mm

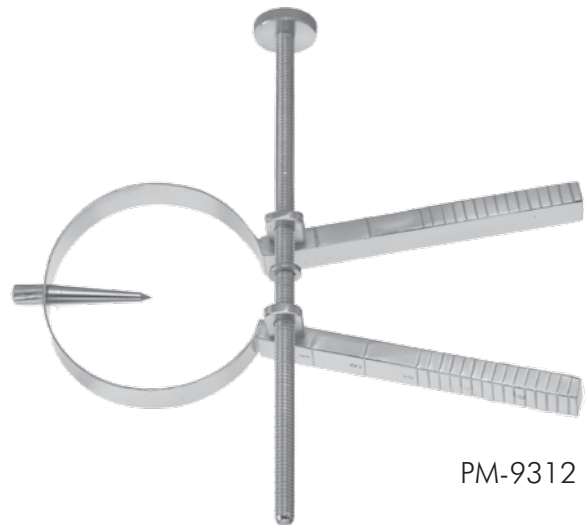

PM-9312

### Ackerman Areola Marker

Catalog#	Width
----------	-------

PM-5005	140 mm
PM-5006	160 mm

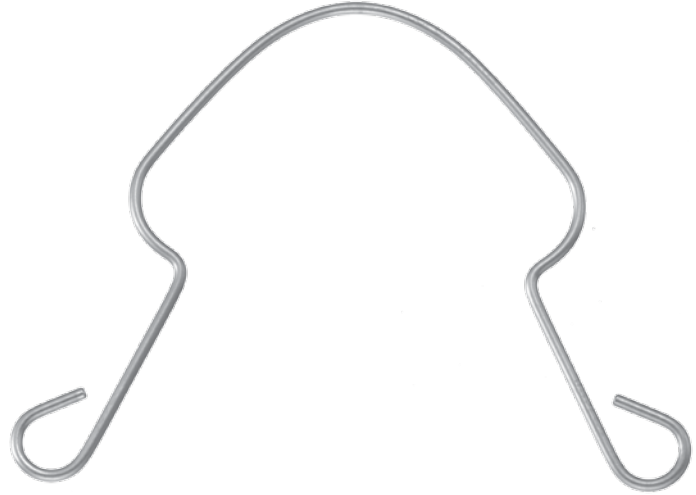

PM-5005

### Washer

Catalog#	Description	Diameter
----------	-------------	----------

PM-5001	Stainless Steel	38 mm
PM-5002	Stainless Steel	42 mm
PM-5003	Stainless Steel	45 mm



PM-895



### D'Assumpcao Rhytidoplasty Marker

Catalog#	Description	Length	Width
PM-390	Without Ratchet	6" (152 mm)	8 mm

Used to precisely mark dissected facial and forehead flaps for excision. Eliminates guesswork on determining the amount of skin to be excised.

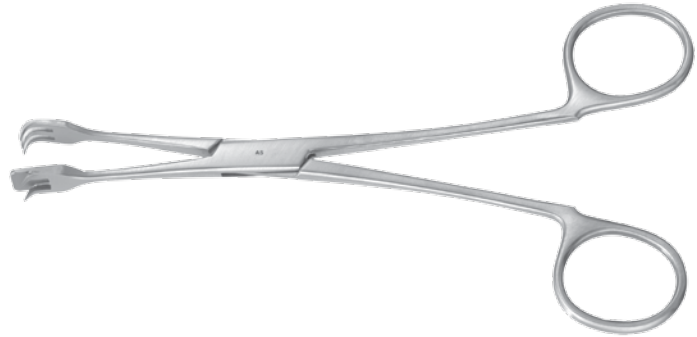
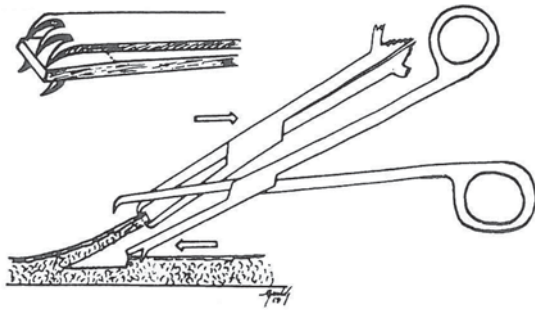

PM-390

### D'Assumpcao Face Lift Marker

Catalog#	Description	Length	Width
PM-391	With Ratchet	6" (152 mm)	8 mm



PM-391

### Kurtay-D'Assumpcao Face Lift Marker

Catalog#	Description	Length	Width
PM-9031	With Ratchet	6" (152 mm)	7.5 mm

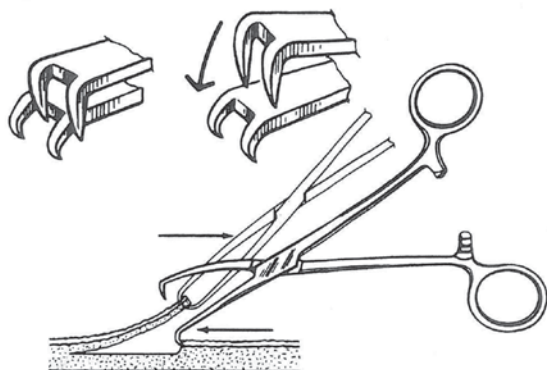

PM-9031

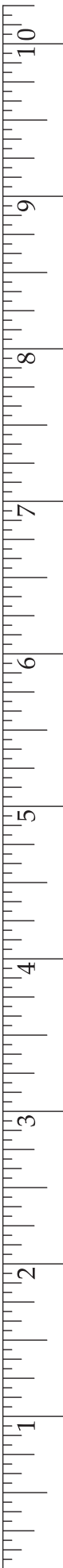



### Pitanguy Small Flap Demarcator

For facial and abdominal flaps to be excised.  
Teeth/serrations mark area of tissue to be excised.

Catalog#	Length	Width
PM-4898	6-1/4" (159 mm)	5 mm



PM-4898

### McCoy Facial Tri-Square

Catalog#	Description
PM-3795	Clear Plastic

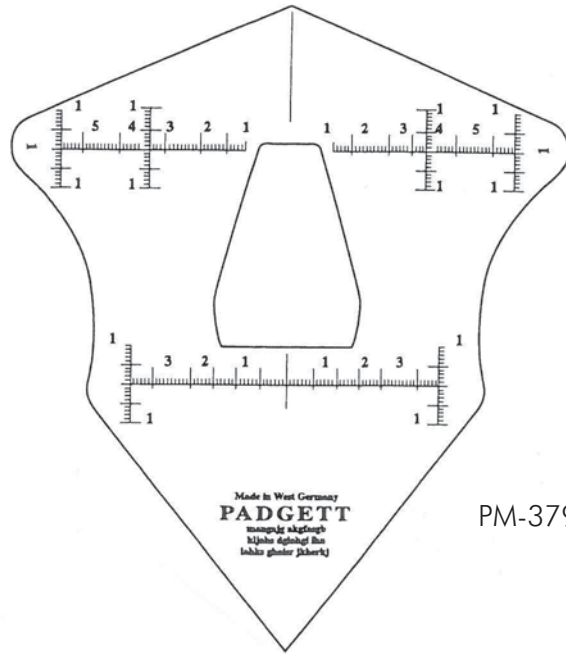

PM-3795

### Duffy Ear Piercer

Catalog#	Length
PM-775	5-1/2" (140 mm)



PM-775





### Pitanguy Large Flap Demarcator

Catalog#	Length	Width
PM-4899	12-1/4" (311 mm)	5 mm



PM-4899

### D'Assumpcao Abdominal Flap Marker

Catalog#	Length	Width
PM-395	10" (254 mm)	9 mm



PM-395

### Lockwood Abdominal Demarcator

Catalog#	Description	Length	Width
PM-397	With Angled Hinge	12-3/4" (324 mm)	9.5 mm



PM-397

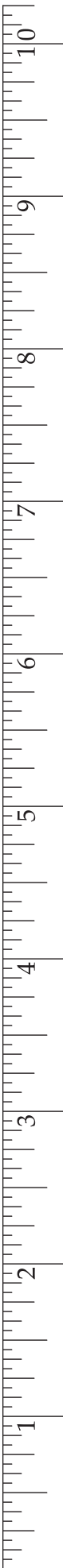

# FIBER OPTIC INSTRUMENTS



## TBTS-Style Fiber Optic Retractors

with ACMI®, Wolf™ and Storz™/Olympus® fittings

Catalog#	Description	Type	Length	Blade (L x W)
PM-897FO	With Suction Port	With Teeth	9" (229 mm)	90 x 24 mm
PM-901FO	With Suction Port	Without Teeth	9" (229 mm)	90 x 24 mm
PM-898FO	With Suction Port	With Teeth	9" (229 mm)	90 x 30 mm
PM-902FO	With Suction Port	Without Teeth	9" (229 mm)	90 x 30 mm



The TBTS-Style Fiber Optic Retractors feature dual Fiber Optic and Smoke Evacuation Suction Ports to optimize visualization during surgical procedures involving electrosurgery. Ten new patterns and sizes are available to fulfill the clinicians' instrument needs and accommodate variation with patient size. The new TBTS-Style Fiber Optic retractors are available with 3 standard interlocking male fittings for connection to the female fittings on ACMI, Richard Wolf and Storz/Olympus fiber optic cables.

Catalog#	Description	Type	Length	Blade (L x W)
PM-899FO	With Suction Port	With Teeth	9" (229 mm)	150 x 30 mm
PM-903FO	With Suction Port	Without Teeth	9" (229 mm)	150 x 30 mm
PM-900FO	With Suction Port	With Teeth	9" (229 mm)	190 x 30 mm
PM-904FO	With Suction Port	Without Teeth	9" (229 mm)	190 x 30 mm

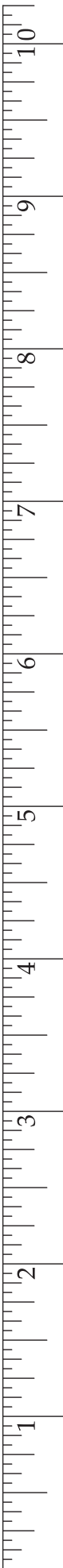

### TBTS-Style Endoplastic Retractor

with ACMI, Wolf and Storz/Olympus fittings

Catalog#	Description	Type	Length	Blade (L x W)
PM-905	With Suction Port	Without Teeth	9" (229 mm)	190 mm



PM-905

### Biggs Face Lift Retractor

with ACMI, Wolf and Storz/Olympus fittings

Catalog#	Description	Length	Blade Width
PM-884FO	Fiber Optic PM-884	8" (203 mm)	5.1 cm



PM-884FO



### Biggs Mammoplasty Retractor

with ACMI, Wolf and Storz/Olympus fittings

Catalog#	Description	Length	Blade Width
PM-529FO	Fiber Optic PM-529	8-1/4" (210 mm)	5.0 cm
PM-530FO	Fiber Optic PM-530	8-1/4" (210 mm)	3.1 cm



### Ferreira Breast Augmentation Retractor

with ACMI, Wolf and Storz/Olympus fittings

Catalog#	Description	Handle Length	Blade Width
PM-895FO	Fiber Optic PM-895	5-1/8" (130 mm)	1" (25 mm) x 6-3/4" (171 mm)

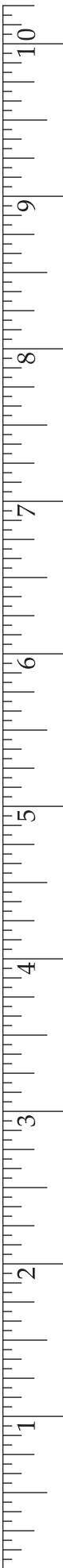

### Ferreira Face Lift Retractor

with ACMI, Wolf and Storz/Olympus fittings

Catalog#	Description	Handle Length	Blade Width
PM-890FO	Fiber Optic PM-890	4-1/4" (108 mm)	7/8" (22 mm) x 4-1/4" (108 mm)



PM-890FO

### Aufricht Retractor

with ACMI, Wolf and Storz/Olympus fittings

Catalog#	Description	Length	Blade Width
PM-5551FO	Fiber Optic PM-5551	8" (203 mm)	7 mm



PM-5551FO

### Freeman Flap Retractor

with ACMI, Wolf and Storz/Olympus fittings

Catalog#	Description	Length	Blade Width
PM-490FO	Fiber Optic PM-490	8" (203 mm)	1/2" (13 mm)
PM-491FO	Fiber Optic PM-491	8" (203 mm)	1" (25 mm)

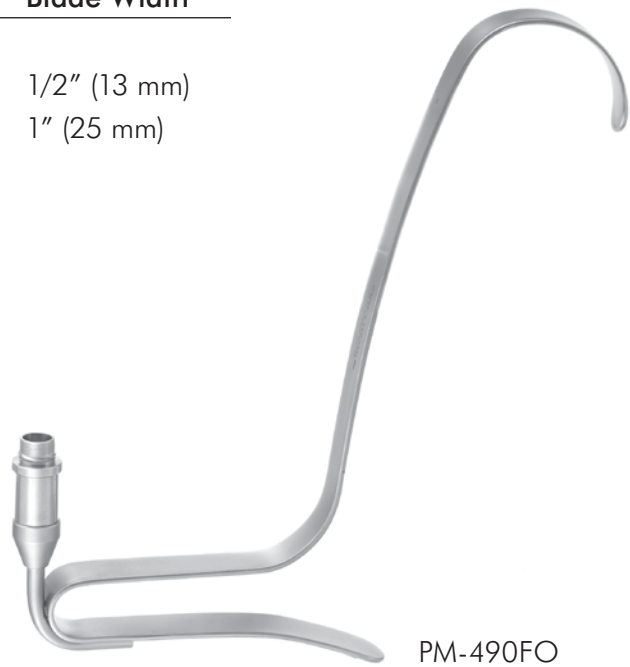

PM-490FO

### Deaver Retractor

with ACMI, Wolf and Storz/Olympus fittings

Catalog#	Description	Length	Blade Width
PM-4570FO	Fiber Optic PM-4570	8" (203 mm)	5/8" (16 mm)
PM-4571FO	Fiber Optic PM-4571	8" (203 mm)	1" (25 mm)



PM-4570FO

### Padgett-Deaver Retractor

with ACMI, Wolf and Storz/Olympus fittings

Catalog#	Description	Handle Length	Blade Width
PM-9057FO	Fiber Optic PM-9057	12" (305 mm)	1" (25 mm)



PM-9057FO

### Killian Speculum

with ACMI, Wolf and Storz/Olympus fittings

Catalog#	Description	Handle Length	Blade Width
PM-4270FO	Fiber Optic PM-4270	5-1/2" (140 mm)	2" (51 mm)



PM-4270FO





## Fiber Optic Light Source - 150 watt Xenon

Miltex offers a complete line of state-of-the-art illumination products and accessories for the operating room and for office-based surgical procedures.

The 150-watt Xenon fiber optic light system provides superior illumination for optimal visualization. This system features a multiport turret for easy selection of various cable connections including Olympus, Storz, Wolf and ACMI-styles. An adjustable attenuator knob enables the user to select the desired light intensity from 0 - 100%. Additional features include a cumulative lamp hour usage meter and easy access for lamp replacement which does not require special tools.

The Xenon lamp is environmentally friendly and unlike metal halide lamps, the Xenon lamp does not require special waste handling for mercury.

Catalog#	Description
----------	-------------

EM-2151LS	Fiber Optic Light Source, 150-watt Xenon
-----------	--

### Specifications

Description:	150-watt Xenon light source with selectable multiport wheel (Standard Ports: Olympus, Storz, Wolf and ACMI-styles)
Controls and Indicators:	Main and Standby Power Switches, Cumulative Lamp Age Indicator, Lamp On Indicator, Lamp Brightness Control 0-100%
Dimensions:	14.0"L x 9.3"W x 4.3"H (356 mm L x 236 mm W x 110 mm H)
Weight:	12.2 lbs. (5.53 kg)
Power Input:	100-120 VAC, 200-240 VAC 50-60 Hz ± 10%
User Manual:	REF# IFU-EM2151LS

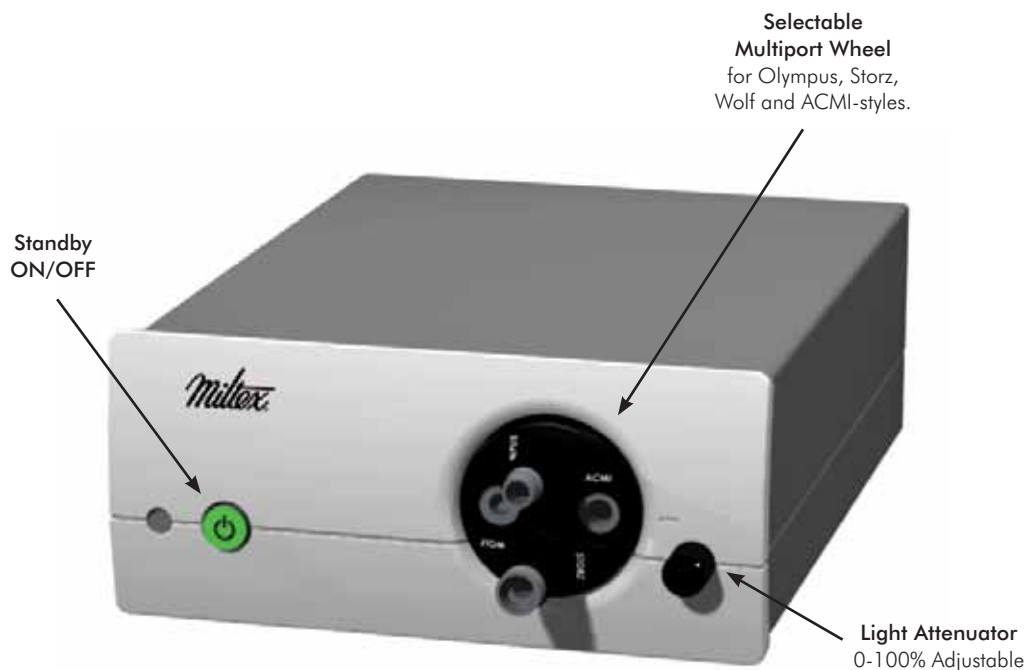

### Fiber Optic Light Source Accessories

Catalog#	Description
EM-2151STAND	Fiber Optic Light Source Floor Stand w/Handle for EM-2151LS
EM-2151BRACK	Fiber Optic Light Source Bracket Adapter for EM-2151STAND

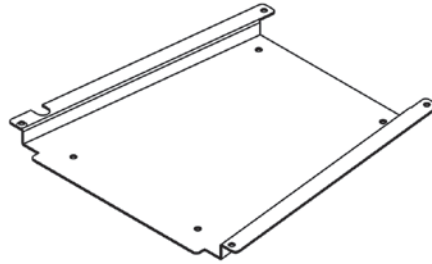

EM-2151BRACK



EM-2151STAND

### Fiber Optic Cable and Accessory

Catalog#	Description	Length
EM-2151	Autoclavable, with universal Olympus & ACMI male light source connection and female ACMI Instrument Coupler	8' (244 cm)
EM-2155	Fiber Optic Cable Adapter for Storz and male ACMI	

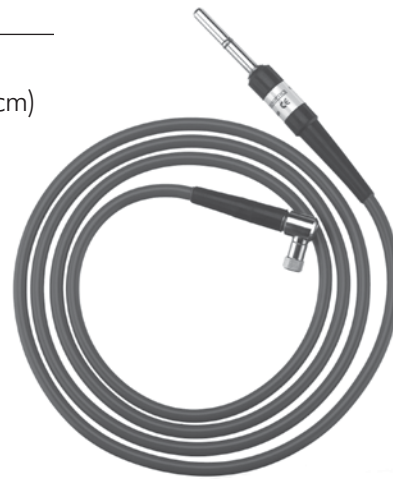

EM-2151



EM-2155

### Replacement Fiber Optic Retractor Adapters

Catalog#	Description
EM-2156	Richard Wolf Fitting
EM-2157	Storz/Olympus Fitting



EM-2156



EM-2157

# OTOLARYNGOLOGY INSTRUMENTS



Ear  
Nasal  
Oral, Tracheal and Throat

## House Alligator Ear Forceps, Miniature

Catalog #	Description	Shaft Length	Jaws
19-415*	Extra Delicate, Serrated	2-3/4" (70 mm)	4 mm
19-420*	Oval Cups, Straight	2-3/4" (70 mm)	0.6 mm x 1 mm cups
19-421*	Oval Cups, Angled Left 15 degrees	2-3/4" (70 mm)	0.6 mm x 1 mm cups
19-422*	Oval Cups, Angled Right 15 degrees	2-3/4" (70 mm)	0.6 mm x 1 mm cups
19-2114*	Alligator & Crimper, Very Flat, Tapered Serrated Jaws	2-3/4" (70 mm)	8 mm
19-2117*	Serrated with Side Opening to Right	2-3/4" (70 mm)	6 mm
19-2118*	Oval Cups, Angled Right 15 degrees	2-3/4" (70 mm)	0.9 mm x 1.8 mm cups
19-2119*	Oval Cups, Angled Left 15 degrees	2-3/4" (70 mm)	0.9 mm x 1.8 mm cups

\*Miltex® Brand



19-415



19-2114



19-420



19-2117



19-421



19-2118



19-422



19-2119



19-2114

## Greven Ear Forceps

Catalog #	Shaft Length	Jaws
19-416*	2-3/4" (70 mm)	5 mm jaws with 2.5 mm tips serrated and touching

\*Miltex® Brand



19-416

### Miltex Ear Forceps

Catalog #	Description	Shaft Length	Jaws
-----------	-------------	--------------	------

19-417*	Oval Cups, Extra Fine	2-3/4" (70 mm)	0.9 mm x 2 mm cups
19-418*	Round Cups, Fine	2-3/4" (70 mm)	0.75 mm cups

\*Miltex® Brand



19-417



19-418



19-417

### McGee Ear Crimper/Wire Closure Forceps

Catalog #	Description	Shaft Length	Jaws
-----------	-------------	--------------	------

19-480*	Short Jaws, Angled Slightly Downward	2-3/4" (70 mm)	3 mm
---------	--------------------------------------	----------------	------

\*Miltex® Brand



19-480

### House-Dieters Malleus Ear Nipper

Catalog #	Shaft Length	Jaws
-----------	--------------	------

19-481*	3" (76 mm)	2 mm
---------	------------	------

\*Miltex® Brand



19-481

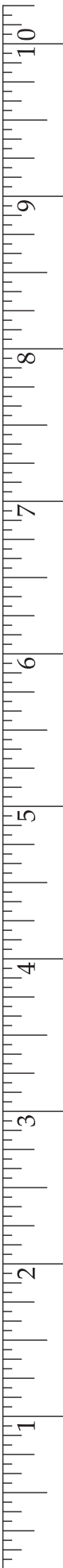

### Bellucci Ear Forceps

Catalog #	Description	Shaft Length	Jaws
-----------	-------------	--------------	------

19-2115*	Serrated	3" (76 mm)	8 mm
----------	----------	------------	------

\*Miltex® Brand



19-2115

### Goodhill Ear Forceps

Catalog #	Description	Shaft Length	Jaws
-----------	-------------	--------------	------

19-2116*	Serrated	3" (76 mm)	5 mm
----------	----------	------------	------

\*Miltex® Brand



19-2116

### Micro Alligator Ear Forceps

Catalog #	Description	Shaft Length	Jaws
-----------	-------------	--------------	------

19-2081*	Serrated	3-1/4" (83 mm)	0.3 mm x 0.7 mm
19-2081-B*	Serrated, Ebony Finish	3-1/4" (83 mm)	0.3 mm x 0.7 mm
19-2090*	Oval Cup	3-1/4" (83 mm)	0.8 mm x 1.09 mm
19-2090-B*	Oval Cup, Ebony Finish	3-1/4" (83 mm)	0.8 mm x 1.09 mm
19-2100*	Serrated	3-1/4" (83 mm)	0.5 mm x 0.9 mm
19-2100-B*	Serrated, Ebony Finish	3-1/4" (83 mm)	0.5 mm x 0.9 mm
19-2110*	Oval Cup	3-1/4" (83 mm)	0.8 mm x 1.17 mm
19-2110-B*	Oval Cup, Ebony Finish	3-1/4" (83 mm)	0.8 mm x 1.17 mm

\*Miltex® Brand

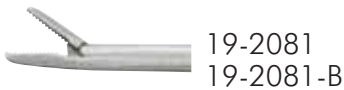
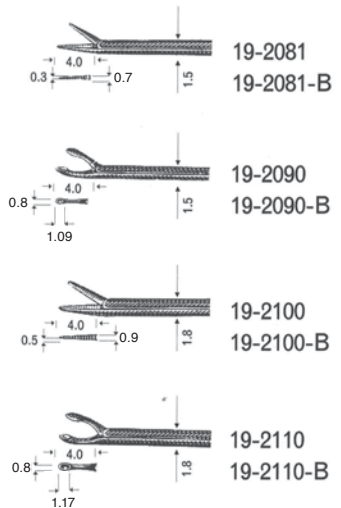

19-2081  
19-2081-B



19-2100  
19-2100-B



19-2090  
19-2090-B



19-2110  
19-2110-B



19-2081

### Bellucci Alligator Scissors

Catalog#	Description	Shaft Length
19-2155*	7 mm Blades, Curved Left	3" (76 mm)
19-2156*	7 mm Blades, Curved Right	3" (76 mm)
19-2160*	7 mm Blades, Straight	3" (76 mm)

\*Miltex® Brand



19-2155



19-2156



19-2160



19-2155

### House-Bellucci Alligator Scissors

Catalog#	Description	Shaft Length
19-2157*	5 mm Blades, Straight	3" (76 mm)
19-2158*	5 mm Blades, Curved Left	3" (76 mm)
19-2159*	5 mm Blades, Curved Right	3" (76 mm)

\*Miltex® Brand



19-2157



19-2158



19-2159



19-2157

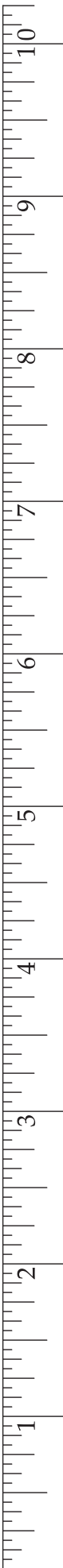

### Paparella-Weitlaner Retractor

Catalog #	Description	Length	Jaw Dimensions
11-625*	2x2 semi-sharp prongs	5" (127 mm)	33 mm inside spread, 13 mm long prongs

\*Miltex® Brand



11-625

### House Elevator and Chisel

Catalog#	Description	Length	Width
19-2518*	Elevator, Tip Angled 15 Degrees, Octagonal Handle, Referred to as "The Gimmick"	6-1/2" (165 mm)	1 mm x 12 mm
19-2520*	Elevator & Chisel, Curved Scraping Tip, Flat Bayonet Handle	6-3/4" (171 mm)	1 mm

\*Miltex® Brand



19-2518



19-2518

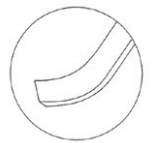

19-2520



19-2520

### Lempert Elevator

Catalog#	Description	Length
19-1341*	Curved 7 mm blade, heavy pattern	7-1/4" (184 mm)

\*Miltex® Brand



19-1341



### Rosen Knife Curette, Octagonal Handle

Catalog#	Description	Length
19-505*	Small 2 mm diameter blade, angled up 45 degrees	6" (152 mm)
19-506*	Large 2.5 mm diameter blade, angled up 45 degrees	6" (152 mm)

\*Miltex® Brand



19-506

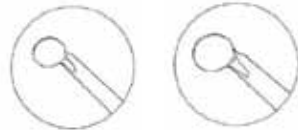

19-505

19-506

### House-Sheehy Knife Curette, Octagonal Handle

Catalog#	Description	Length
19-2504*	2 mm diameter semi-sharp blade, malleable shaft	6-1/2" (165 mm)

\*Miltex® Brand



19-2504



19-2504

### House Curette, Double-Ended with Flat Handle

Catalog#	Description	Length	Scoop 1	Scoop 2
19-2528*	Light Angle, Oval Cups	7" (178 mm)	2 mm x 2.5 mm	2.5 mm x 3 mm
19-2529*	Strong Angle, Oval Cups	7" (178 mm)	2 mm x 2.5 mm	2.25 mm x 3 mm
19-2530*	Strong Angle, Oval Cups	6" (152 mm)	2 mm x 2.5 mm	2.25 mm x 3 mm

\*Miltex® Brand



19-2529

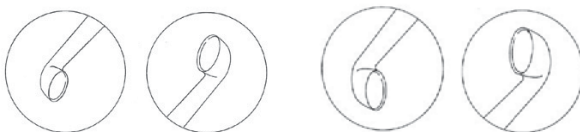

19-2528

19-2529  
19-2530

### Rosen Picks with Octagonal Handle

Catalog#	Description	Length
19-211*	Curved, 3 mm from tip	6-1/8" (156 mm)
19-212*	Curved, 1.5 mm from tip	6-1/8" (156 mm)

\*Miltex® Brand

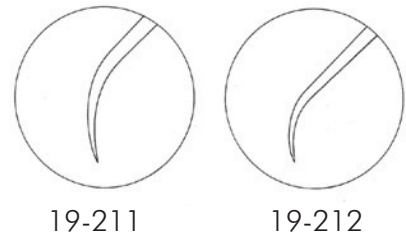

### House Picks with Malleable Shaft and Octagonal Handle

Catalog#	Description	Length
19-2505*	Strut Caliper, 5 mm mark from tip	6-1/2" (165 mm)
19-2510*	Barbara Pick, straight point	6-1/4" (159 mm)
19-2511*	Obtuse Pick, 0.25 mm long point angled 30 degrees	6-1/4" (159 mm)
19-2512*	Oval Window Pick, 0.33 mm long point angled 30 degrees	6-1/2" (165 mm)
19-2513*	Oval Window Pick, 0.66 mm long point angled 30 degrees	6-1/2" (165 mm)
19-2514*	Oval Window Pick, 0.33 mm long point angled 90 degrees	6-1/2" (165 mm)
19-2516*	Oval Window Pick, 0.33 mm long point angled 90 degrees	6-1/2" (165 mm)
19-2515*	Strut Pick, 0.5 mm long point angled 90 degrees	6-1/2" (165 mm)
19-2517*	Strut Pick, 0.66 mm long point angled 90 degrees	6-1/2" (165 mm)

\*Miltex® Brand



19-2505      19-2510      19-2511      19-2512      19-2513

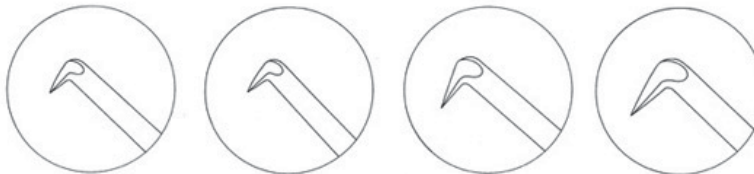

19-2514      19-2516      19-2515      19-2517

## House Hooks with Malleable Shaft and Octagonal Handle

Catalog#	Description	Length
19-2502*	1 mm long tip angled left 90 degrees, shaft angled 8 degrees	6-1/8" (156 mm)
19-2503*	1 mm long tip angled right 90 degrees, shaft angled 8 degrees	6-1/8" (156 mm)

\*Miltex® Brand



19-2502

19-2502

19-2503

## House Needles with Octagonal Handle

Catalog#	Description	Length
19-2500*	Curved Tip, Semi-Sharp Point, Malleable Shaft	6-1/4" (159 mm)
19-2501*	ROSEN Type Curved and Slightly Dulled Tip, Malleable Shaft	6-1/4" (159 mm)

\*Miltex® Brand

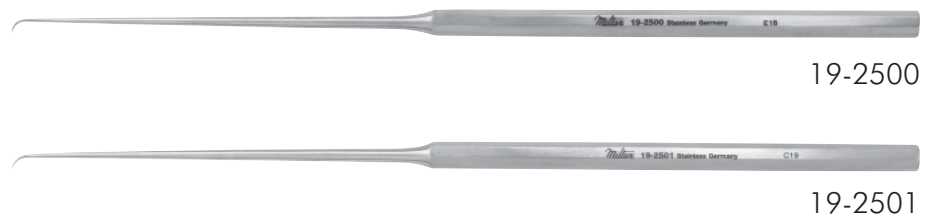

19-2500

19-2501

### House Knives with Octagonal Handle

Catalog#	Description	Length	Blade
19-2522*	Tympanoplasty Knife	6-1/2" (165 mm)	7 mm curved blade
19-2523*	Lancet No. 2 Knife	6-1/2" (165 mm)	2 mm x 3 mm tapered tip angled 45 degrees
19-2524*	Incudostapedial Joint Knife	6-1/2" (165 mm)	0.5 mm wide x 1.5 mm long, blade angled 20 degrees
19-2525*	Incudostapedial Joint Knife	6-1/2" (165 mm)	0.75 mm diameter blade angled 60 degrees
19-2526*	Sickle No.1 Knife	6" (152 mm)	0.75 mm curved blade
19-2527*	Myringotomy Knife	6" (152 mm)	3.5 mm blade

\*Miltex® Brand



19-2522



19-2523



19-2524

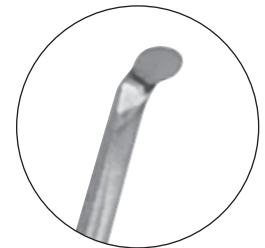

19-2525



19-2526

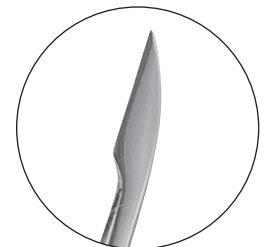

19-2527

19-2522 19-2523 19-2524 19-2525 19-2526 19-2527

### Rosen Suction Tube, 6 cm working length, includes stylet

**Catalog #    Size**

---

19-530*	14 gauge (2.1 mm)
19-531*	15 gauge (1.8 mm)
19-532*	16 gauge (1.6 mm)
19-533*	17 gauge (1.4 mm)
19-534*	18 gauge (1.2 mm)
19-535*	19 gauge (1.0 mm)
19-536*	20 gauge (0.9 mm)
19-537*	22 gauge (0.7 mm)
19-538*	24 gauge (0.55 mm)
19-539*	26 gauge (0.45 mm)

\*Miltex® Brand

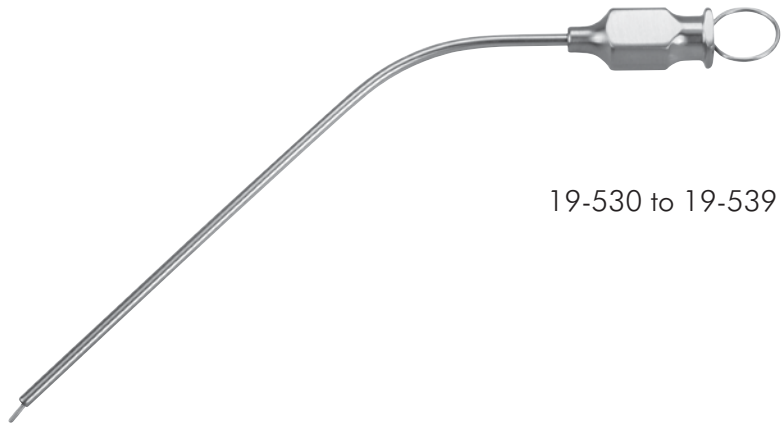

19-530 to 19-539

### House Cut-off Adapter, for use with Rosen Suction Tubes

**Catalog#    Description**

---

19-540*	4 mm diameter tubing end, stainless steel
19-541*	4 mm diameter tubing end, chrome

\*Miltex® Brand



19-540



19-541

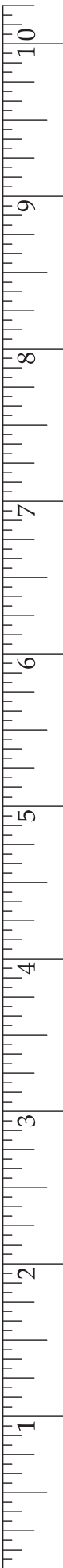



### William-House Suction - Irrigation Tubes with Thumb Plate and Cut-Off

Catalog #	Size	Working Length
19-550*	2 x 2.5 Fr.	8.5 cm
19-551*	2.5 x 4 Fr.	7.0 cm
19-552*	2.5 x 4 Fr.	9.5 cm
19-553*	4 x 5 Fr.	7.0 cm
19-554*	5 x 7 Fr.	9.5 cm
19-555*	4 x 5 Fr.	9.5 cm
19-557*	7 x 10 Fr.	9.5 cm
19-558*	8 x 12 Fr.	9.5 cm
19-559*	12 x 14 Fr.	9.5 cm
19-562*	5 x 5 Fr.	9.5 cm
19-563*	6 x 8 Fr.	9.5 cm
19-564*	6 x 9 Fr.	9.5 cm
19-565*	6 x 14 Fr.	9.5 cm



19-563

\*Miltex® Brand

### Schuknecht Suction Tubes with Thumb Plate and Cut-Off

Catalog#	Size	Working Length
19-585*	20 gauge	7.8 cm
19-586*	24 gauge	7.8 cm

\*Miltex® Brand



19-586

## Dingman Otoabrader

Designed for effectively scoring ear cartilage during otoplasty procedures.

Catalog#	Description	Length
PM-409	Right and Left Pattern, Set of Two	6-1/8" (156 mm)

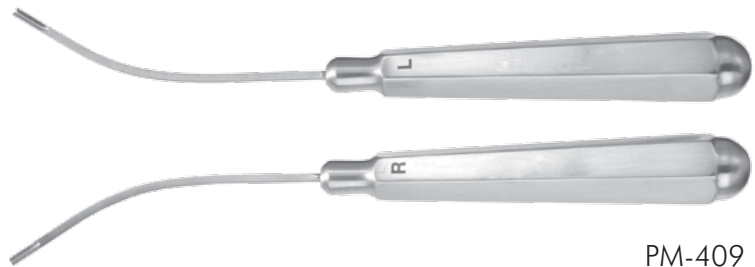

PM-409

## Tuning Forks

Catalog#	Description
19-113*	C-128 Vibrations (Student Grade)
19-115*	C-256 Vibrations (Student Grade)
19-117*	C-512 Vibrations (Student Grade)
19-100*	C-64 Vibrations (Medical Grade)
19-102*	C-128 Vibrations (Medical Grade)
19-104*	C-256 Vibrations (Medical Grade)
19-106*	C-512 Vibrations (Medical Grade)
19-108*	C-1024 Vibrations (Medical Grade)
19-110*	C-2048 Vibrations (Medical Grade)
19-112*	C-4096 Vibrations (Medical Grade)
19-120*	Set of 5 Tuning Forks: C-128, C-256, C-512, C-1024 and C-2048 in fitted zippered case
19-120A*	Fitted zippered case only for tuning fork set

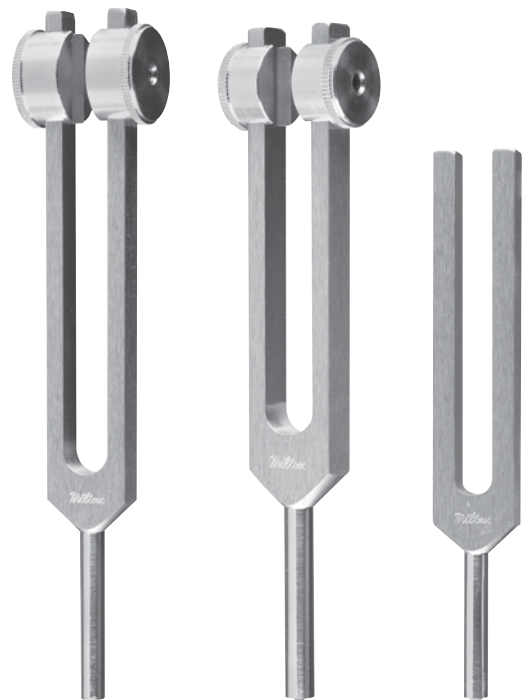

19-102

19-104

19-106

\*Miltex® Brand

## Shea Speculum Holder

Catalog#	Length
19-60*	11-3/4" (298 mm)

\*Miltex® Brand



19-60

## Suction Nasal Forceps

Catalog#	Description	Shaft Length
20-470*	Straight Fenestrated Jaw, Size 1, 4 mm	4" (102 mm)
20-471*	Angled Fenestrated Jaw, Size 1, 4 mm	4" (102 mm)
20-472*	Straight Fenestrated Jaw, Size 0, 3.5 mm	4" (102 mm)
20-473*	Angled Fenestrated Jaw, Size 0, 3.5 mm	4" (102 mm)
20-474*	Straight Fenestrated Jaw, Size 00, 2.5 mm	4" (102 mm)
20-475*	Angled Fenestrated Jaw, Size 00, 2.5 mm	4" (102 mm)
20-476*	Straight Solid Upper Jaw, Size 0, 3.5 mm	4" (102 mm)
20-477*	Angled Solid Upper Jaw, Size 0, 3.5 mm	4" (102 mm)
20-478*	Stylet for Suction Nasal Forceps/Punch Rongeurs	-

\*Miltex® Brand

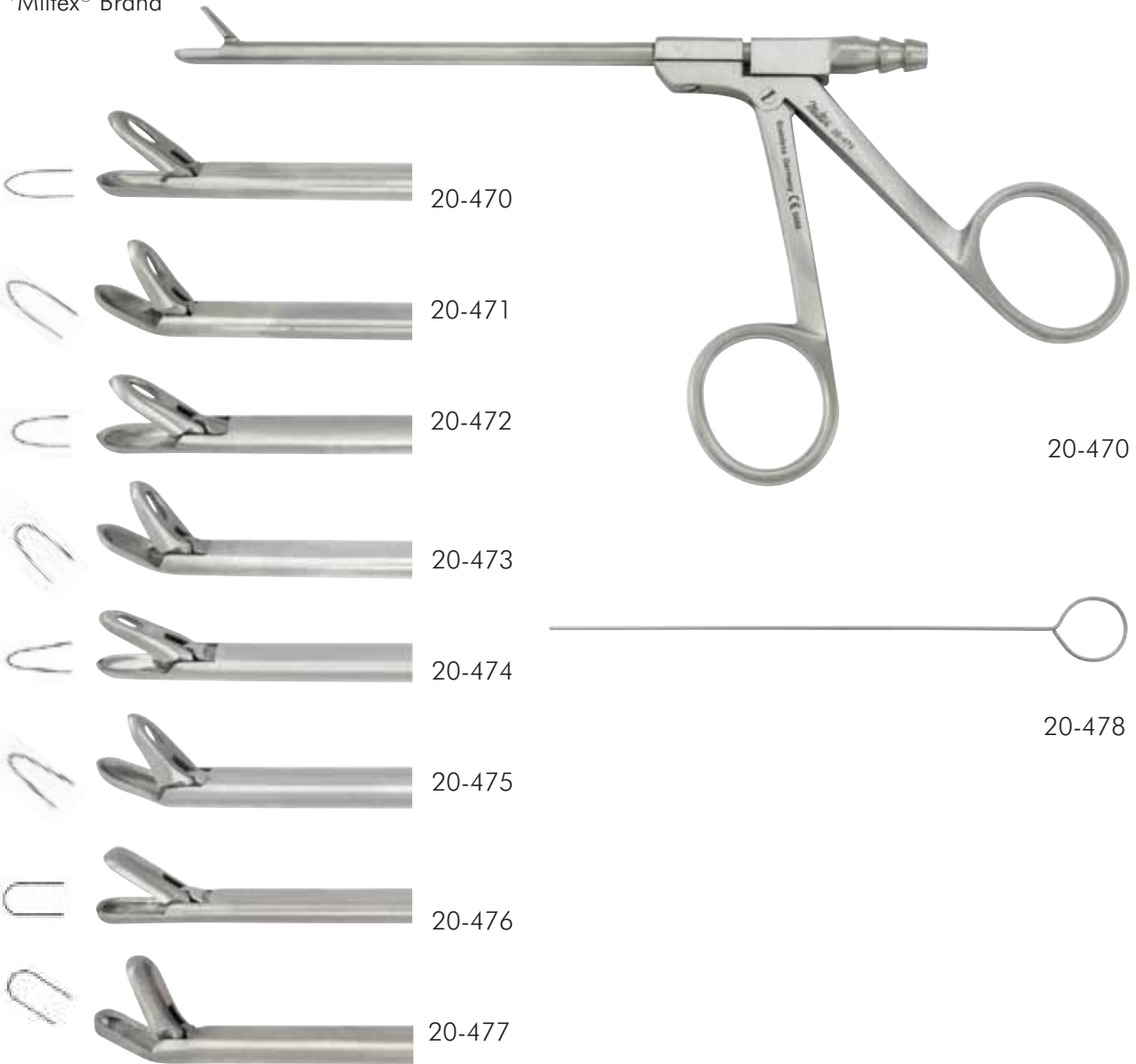



### Blakesley-Wilde Ethmoid Forceps (Fenestrated Cups)

Catalog#	Description	Shaft Length	Cups
20-565*	Pointed, Upturned 45 degrees	4-1/4" (108 mm)	4 mm x 10 mm
20-606*	Upturned 45 degrees	4-1/2" (114 mm)	3.5 mm x 10 mm
20-607*	Upturned 45 degrees	4-1/2" (114 mm)	4 mm x 10 mm
20-608*	Upturned 90 degree	4-1/2" (114 mm)	3.5 mm x 10 mm
20-609*	Upturned 90 degree	4-1/2" (114 mm)	4 mm x 10 mm

\*Miltex® Brand



### Ethmoid Forceps, Pediatric (Fenestrated Cups)

Catalog#	Description	Shaft Length
20-587*	Straight	3-3/4" (95 mm)
20-588*	Upturned, 45 degrees	3-3/4" (95 mm)
20-589*	Upturned, 90 degrees	3-3/4" (95 mm)

\*Miltex® Brand

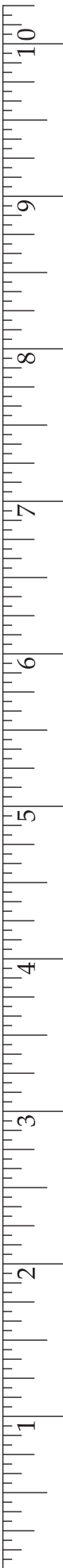
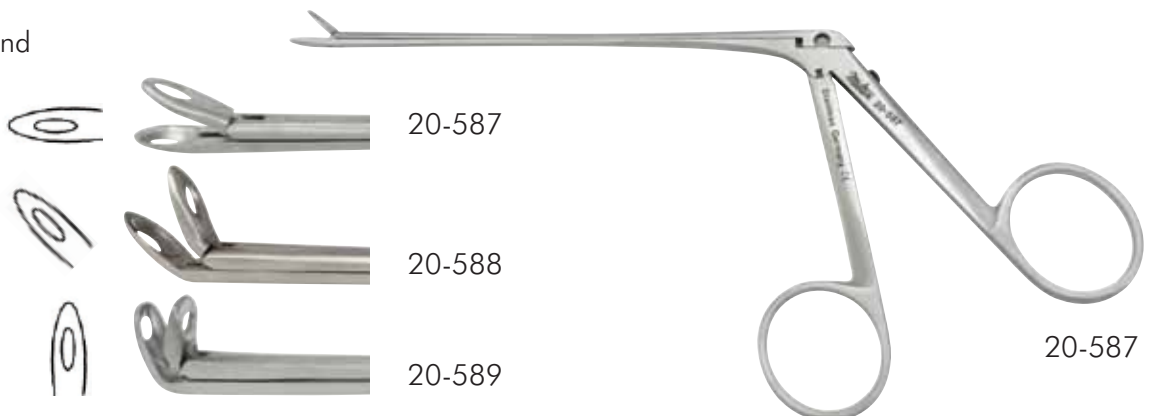

### Wilde Nasal Forceps

Catalog #	Description	Shaft Length	Cups
20-585*	Straight, Fenestrated	4" (102 mm)	5 mm x 10 mm
20-586*	Upturned, Fenestrated	4" (102 mm)	5 mm x 10 mm

\*Miltex® Brand

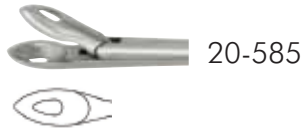

### Blakesley Nasal Forceps

Catalog #	Description	Shaft Length	Cups
20-600*	No. 0, Fenestrated	5-1/2" (140 mm)	3.5 mm x 7 mm
20-601*	No. 1, Fenestrated	5-1/2" (140 mm)	4 mm x 10 mm
20-602*	No. 2, Fenestrated	5-1/2" (140 mm)	4.5 mm x 11 mm

\*Miltex® Brand



### Miltex Sinus Cup Forceps

Catalog #	Shaft Length	Cups
20-566*	4-1/8" (105 mm)	3 mm

\*Miltex® Brand



### Weil Nasal Forceps

**Catalog # Description Shaft Length**

- 20-567\* Straight, 5 mm x 8 mm 4" (102 mm)
- 20-568\* Upturned, 5 mm x 8 mm 4" (102 mm)

\*Miltex® Brand



### Takahashi Nasal Forceps

Slender shafts of varying lengths allow for removal of small fragments or polyps deep in the nasal cavity.

**Catalog# Shaft Length Jaw**

- 20-570\* 4-1/2" (114 mm) 10 mm x 2.5 mm
- 20-572\* 4-1/2" (114 mm) 10 mm x 4 mm
- 20-575\* 6-3/8" (162 mm) 10 mm x 2 mm
- 20-576\* 6-3/8" (162 mm) 10 mm x 3 mm
- 20-577\* 6-3/8" (162 mm) 10 mm x 4 mm

\*Miltex® Brand



### Hildyard Post-Nasal Biopsy Forceps







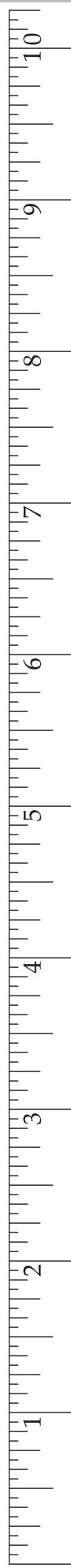



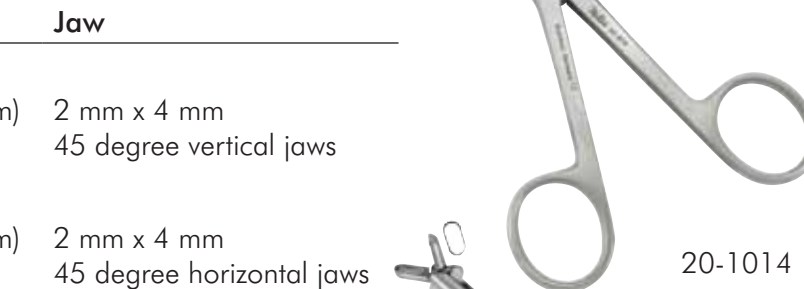

**Catalog # Shaft Length Cups**

- 20-605\* 4-3/4" (121 mm) 3.5 mm

\*Miltex® Brand



**Nasal Forceps with Luer Lock Port & Channel**

Catalog#	Description	Shaft Length	Jaw	
20-1010*	Frontal Sinus Recess Giraffe Forceps	5-1/2" (140 mm)	2 mm x 4 mm 45 degree vertical jaws	
20-1012*	Frontal Sinus Recess Giraffe Forceps	5-1/2" (140 mm)	2 mm x 4 mm 45 degree horizontal jaws	
20-1014*	Frontal Sinus Recess Giraffe Forceps	5-1/2" (140 mm)	2 mm x 4 mm 90 degree vertical jaws	
20-1016*	Frontal Sinus Recess Giraffe Forceps	5-1/2" (140 mm)	2 mm x 4 mm 90 degree horizontal jaws	
20-1018*	Frontal Sinus Recess Giraffe Forceps	5-1/2" (140 mm)	3 mm x 5 mm 45 degree vertical jaws	
20-1020*	Frontal Sinus Recess Giraffe Forceps	5-1/2" (140 mm)	3 mm x 5 mm 45 degree horizontal jaws	
20-1022*	Biopsy and Grasping Forceps	4-3/4" (121 mm)	3 mm x 5 mm cups 70 degree vertical jaws	
20-1024*	Biopsy and Grasping Forceps	4-3/4" (121 mm)	3 mm x 5 mm cups 70 degree horizontal jaws	
20-1026*	Biopsy and Grasping Forceps	4-3/4" (121 mm)	3 mm x 5 mm cups 110 degree vertical jaws	
20-1028*	Biopsy and Grasping Forceps	4-3/4" (121 mm)	3 mm x 5 mm cups 110 degree horizontal jaws	
20-1030*	Pear Shaped Cup Jaw Forceps	4" (102 mm)	horizontal opening 80 degrees upturned	
20-1032*	Pear Shaped Cup Jaw Forceps	4" (102 mm)	horizontal opening 45 degrees upturned	

\*Miltex® Brand

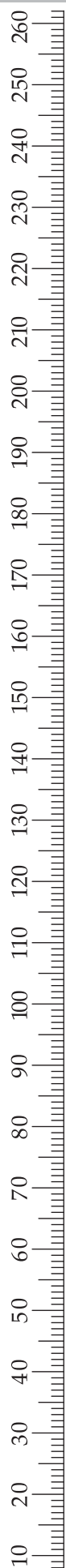

### Weil-Blakesley Through Cutting Forceps

Catalog #	Description	Shaft Length	Jaws
20-712*	Straight	4" (102 mm)	2 mm
20-713*	Straight	4" (102 mm)	2.5 mm
20-714*	Straight	4" (102 mm)	3 mm
20-715*	Up-Angled 45 degree	4" (102 mm)	2 mm
20-716*	Up-Angled 45 degree	4" (102 mm)	2.5 mm
20-717*	Up-Angled 45 degree	4" (102 mm)	3 mm

\*Miltex® Brand



### Nasal Biopsy Forceps, Double-Action with Luer Lock Cleaning Port

Catalog #	Description	Shaft Length	Jaws
20-1000*	Straight	6" (152 mm)	3 mm round jaws
20-1002*	70 degrees vertical jaws	6" (152 mm)	3 mm round jaws
20-1004*	70 degrees horizontal jaws	6" (152 mm)	3 mm round jaws
20-1006*	110 degrees vertical jaws	6" (152 mm)	3 mm round jaws
20-1008*	110 degrees horizontal jaws	6" (152 mm)	3 mm round jaws
20-1095*	Luer Lock replacement cap	-	-
20-478*	Stylet for Suction Nasal Forceps and Punch Rongeurs	-	-

\*Miltex® Brand

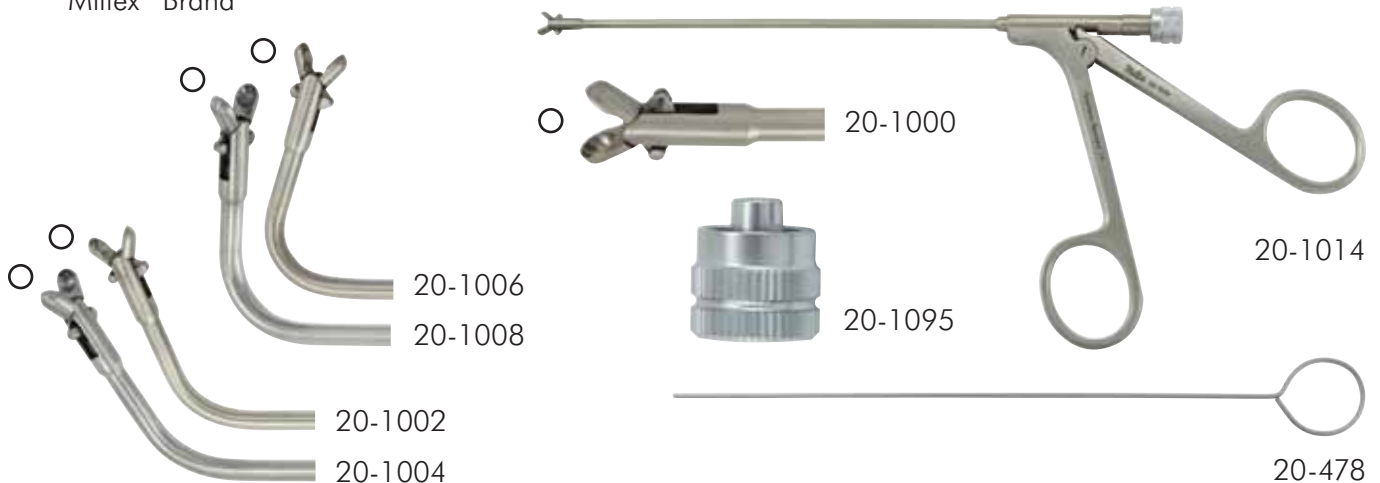

### Nasal Rotating Back-Biting Forceps

Catalog #	Description	Shaft Length	Jaws
-----------	-------------	--------------	------

20-699*	Adult	7-3/4" (197 mm)	2.5 mm x 7 mm bite
---------	-------	-----------------	--------------------

\*Miltex® Brand



20-699

### Antrum Punch Side-Biting Forceps

Catalog #	Description	Shaft Length	Jaws
-----------	-------------	--------------	------

20-700*	Left	5" (127 mm)	3.5 mm x 8.5 mm bite
20-701*	Right	5" (127 mm)	3.5 mm x 8.5 mm bite

\*Miltex® Brand

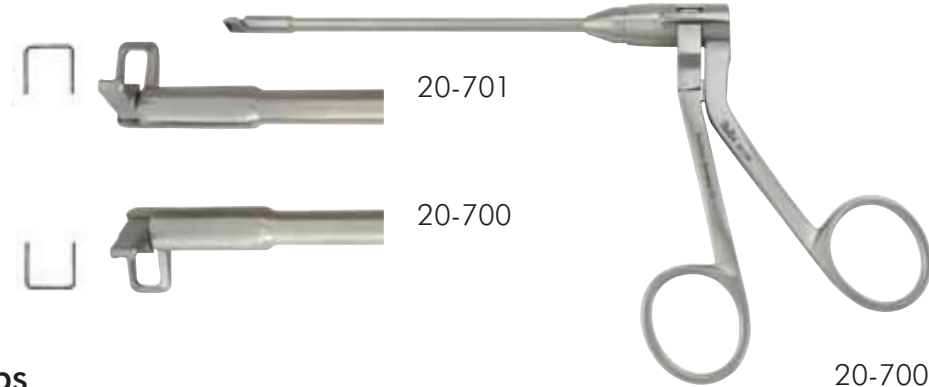

20-701

20-700

20-700

### Antrum Punch Forceps

Catalog #	Description	Shaft Length	Jaws
-----------	-------------	--------------	------

20-702*	45 degree forward biting	5-3/4" (146 mm)	4 mm x 5 mm bite
20-703*	90 degree up-biting	5-1/4" (133 mm)	4 mm x 4 mm bite
20-704*	45 degree backward biting	5-3/4" (146 mm)	4 mm x 5 mm bite
20-705*	90 degree down-biting	5-1/4" (133 mm)	4 mm x 4 mm bite

\*Miltex® Brand

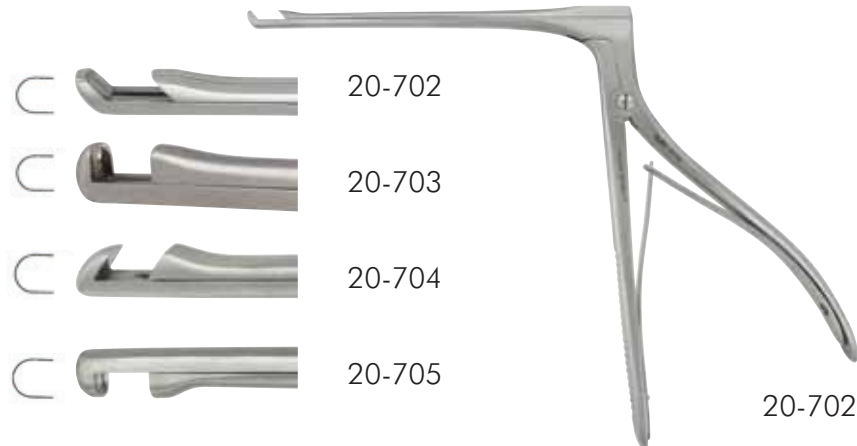

20-702

20-703

20-704

20-705

20-702

### McKenty Sphenoid Punch Forceps, Through Cutting

Catalog #	Description	Shaft Length	Jaws
20-558*	Small jaws, reversible, 2 mm footplate depth, angled 85 degrees	5-3/4" (146 mm)	1.5 mm x 4 mm

\*Miltex® Brand

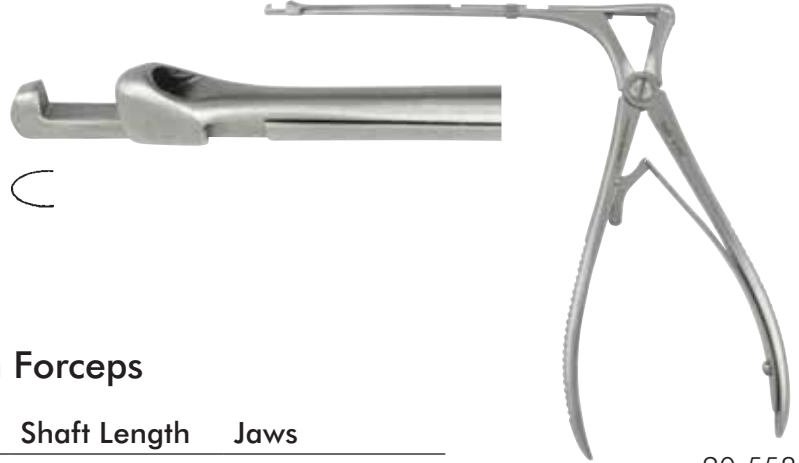

20-558

### Hajek-Kofler Sphenoid Punch Forceps

Catalog #	Description	Shaft Length	Jaws
20-559*	Small solid biting jaws, reversible, original model with fixation nut, 3 mm footplate depth, angled 90 degrees	6" (152 mm)	3 mm x 7 mm

\*Miltex® Brand



20-559

### Hajek-Kofler Sphenoid Punch Forceps

Catalog #	Description	Shaft Length	Jaws
20-560*	Delicate jaws, up and through-cutting, 3 mm footplate depth, angled 85 degrees	6-3/8" (162 mm)	2 mm x 3 mm

\*Miltex® Brand



20-560



### Circular Cutting Punch

Catalog #	Shaft Length	Jaws
20-708*	7-5/64" (180 mm)	3.5 mm bite, straight
20-709*	7-5/64" (180 mm)	3.5 mm bite, up 45 degrees
20-710*	7-1/8" (181 mm)	4.5 mm bite, straight
20-711*	7-1/8" (181 mm)	4.5 mm bite, up 45 degrees

\*Miltex® Brand

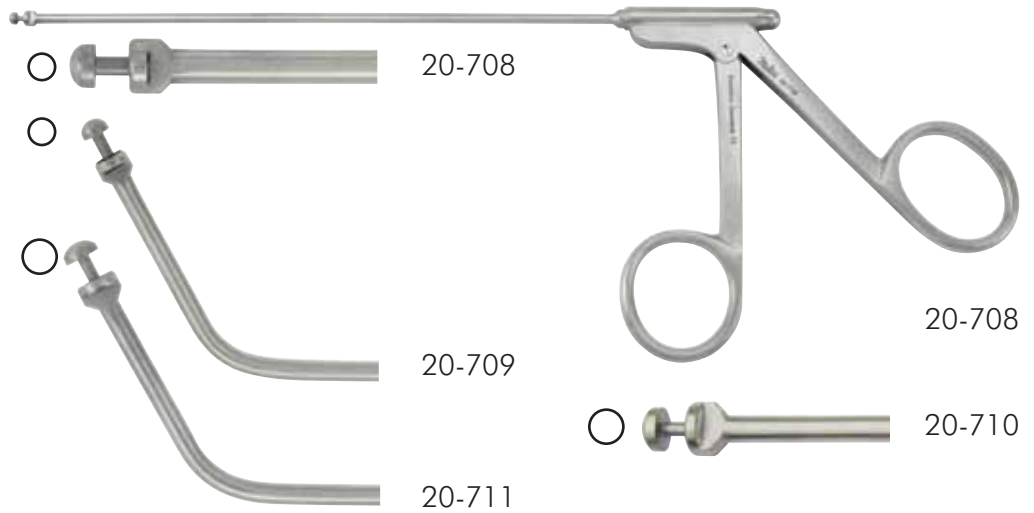

### Ostrum Punch, Back-Biting with Luer Lock Cleaning Port

Catalog #	Description	Shaft Length	Jaws
20-1034*	Straight Bite	4-1/8" (105 mm)	2.5 mm x 7 mm bite
20-1036*	Left Bite	4-1/8" (105 mm)	2.5 mm x 7 mm bite
20-1038*	Right Bite	4-1/8" (105 mm)	2.5 mm x 7 mm bite
20-1040*	Pediatric, Straight Bite	4-1/8" (105 mm)	1.5 mm x 7 mm bite
20-1042*	Pediatric, Left Bite	4-1/8" (105 mm)	1.5 mm x 7 mm bite
20-1044*	Pediatric, Right Bite	4-1/8" (105 mm)	1.5 mm x 7 mm bite

\*Miltex® Brand

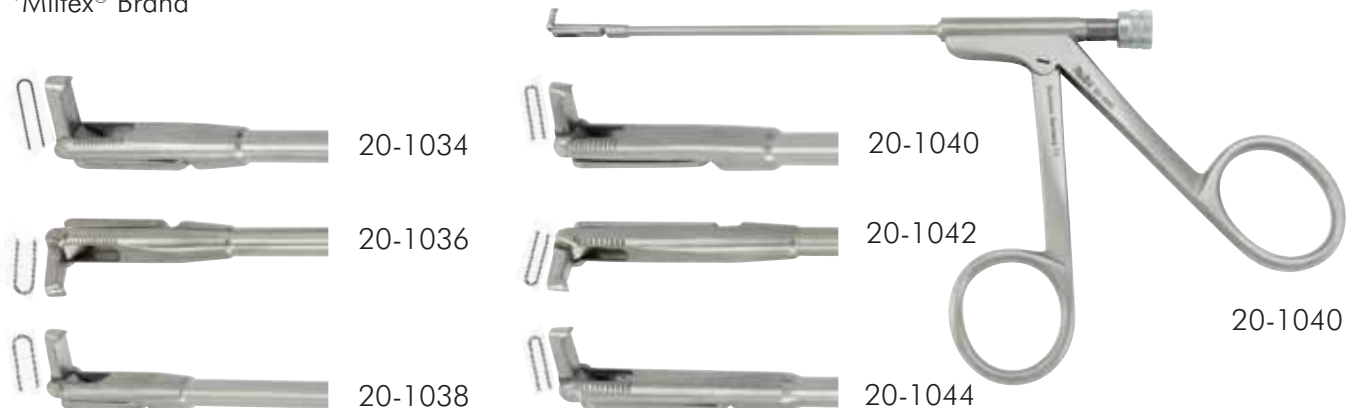



### Kerrison-Costen Rongeur

Catalog #	Description	Shaft Length	Jaws
18-1997*	Curved, 3 mm footplate depth, angled 90 degrees	3-1/4" (85 mm)	4 mm x 9 mm bite

\*Miltex® Brand



18-1997

### Miltex Punch Rongeur

Catalog #	Shaft Length	Jaws
20-706*	6" (152 mm)	1.5 mm bite
20-707*	6" (152 mm)	2.5 mm bite

\*Miltex® Brand



20-706

20-707

20-707



## Wright-Rubin Septum Morselizer

Catalog#	Description	Jaw	Length
20-550*	Straight, Long Serrated Jaws with Pyramid Shaped Teeth and Clip	20 mm x 5 mm	8-1/2" (214 mm)
20-553*	Replacement Slip-On Clip for 20-550		

\*Miltex® Brand



20-550

## Jansen-Middleton Septum Forceps

Catalog#	Description	Length	Jaw
20-554*	Solid Spoon Shaped Cup	7-1/2" (191 mm)	15 mm x 5 mm
20-556*	Thru-Cutting Jaws	7-1/2" (191 mm)	19 mm x 4 mm
20-557*	Thru-Cutting Jaws	7-1/2" (191 mm)	14 mm x 4 mm

\*Miltex® Brand



20-554



20-557

## Nasal Scissors

Catalog#	Description	Shaft Length
20-170*	11 mm Blades, Straight	4-1/2" (114 mm)
20-171*	11 mm Blades, Curved Left	4-1/2" (114 mm)
20-172*	11 mm Blades, Curved Right	4-1/2" (114 mm)

\*Miltex® Brand



20-170



20-171



20-172



20-170

### Boies Nasal Fracture Elevator

Designed for elevation and manipulation of bone fragments during nasal fracture repair.

Catalog#	Description	Length
----------	-------------	--------

21-61*	9 mm Wide Tip	7-3/4" (197 mm)
--------	---------------	-----------------

\*Miltex® Brand



21-61

### Goldman Displacer Septum Elevator

Catalog#	Description	Length
----------	-------------	--------

21-65*	6 mm Wide Tip, Slight Tapered Blade	7-1/2" (191 mm)
--------	-------------------------------------	-----------------

\*Miltex® Brand



21-65

### Septum Ball End Elevator

Catalog#	Description	Length	Width 1	Width 2
----------	-------------	--------	---------	---------

20-240*	Double-Ended With Ball Tips	6-3/4" (171 mm)	2 mm	2.5 mm
---------	-----------------------------	-----------------	------	--------

\*Miltex® Brand



20-240

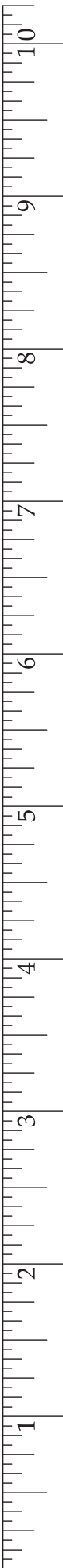

### St. Clair-Thompson Adenoid Forceps

Catalog #	Description	Length	Jaws
-----------	-------------	--------	------

20-929*	Ring Jaws	7-1/4" (184 mm)	5 mm x 10 mm
---------	-----------	-----------------	--------------

\*Miltex® Brand

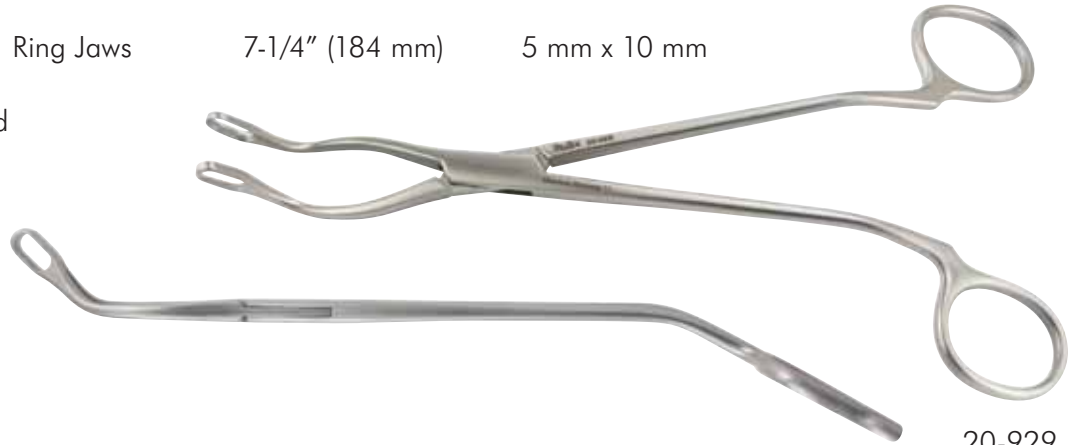

20-929

### King Adenoid Punch Forceps

Catalog #	Description	Shaft Length	Jaws
-----------	-------------	--------------	------

20-930*	Triangular Jaws (No. 1) and strongly curved shaft	4-1/8" (105 mm)	6 mm upper jaw and 7 mm lower basket
---------	---	-----------------	--------------------------------------

\*Miltex® Brand



20-930

### Reverse Curve Adenoid Curette

Catalog #	Blade Size	Length
-----------	------------	--------

20-810*	size 0, 11 mm	8-1/4" (210 mm)
20-811*	size 1, 13 mm	8-1/4" (210 mm)
20-812*	size 2, 15 mm	8-1/4" (210 mm)
20-813*	size 3, 17 mm	8-1/4" (210 mm)
20-814*	size 4, 19 mm	8-1/4" (210 mm)

\*Miltex® Brand



20-810

## Dingman Mouth Gag

Excellent for cleft palate procedures

**Catalog# Description**

2-115\* Complete set with three tongue blades, adjustable upper blades & cheek retractors, grooved endotracheal type tongue blades, coil spring on upper frame for suture handling

\*Miltex® Brand

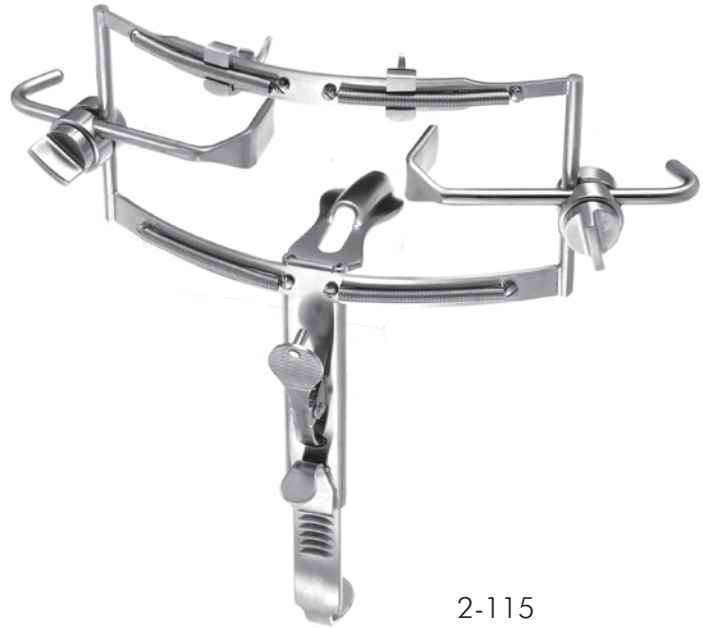

## Tongue Blade

Catalog#	Description	Length	Blade Dimension
2-116*	For Dingman Mouth Gag, Size Small	6" (152 mm)	24 mm x 52 mm
2-117*	For Dingman Mouth Gag, Size Medium	6" (152 mm)	28 mm x 55 mm
2-118*	For Dingman Mouth Gag, Size Large	6" (152 mm)	30 mm x 68 mm

\*Miltex® Brand



2-116 thru 2-118

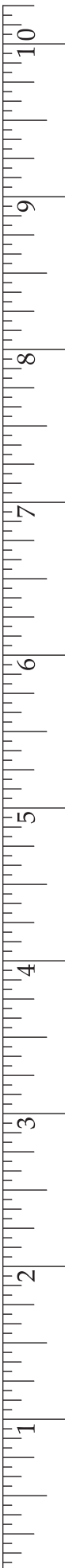

## Millard-Dingman Mouth Gag

**Catalog#**      **Description**

---

PM-110      Comes complete with  
three tongue blades



## Tonsil Needles with Luer Lock and Stylet

**Catalog#**      **Description**      **Length**

---

20-426\*      23 Gauge Straight, Extended Needle Length 19 mm      4-1/4" (108 mm)

20-427\*      23 Gauge Curved, Extended Needle Length 13 mm      4-1/4" (108 mm)

\*Miltex® Brand



# **DISPOSABLE READY-TO-USE PRODUCTS**



**Biopsy Punches  
BiopBlade™  
Dermal Curettes  
Scalpels  
Blades  
Ear Curettes  
ENT Packing**

## Biopsy Punch, Sterile

- Seamless, stainless steel, razor-sharp cutting edges eliminate torn or pulled biopsies
- Ribbed handle provides comfort and control
- Convenience of disposables, single-use
- Sterile, 5-year shelf life
- Sizes clearly marked on each punch
- Individual color-coded blister packs

## Biopsy Punch with Plunger System

- Effortless ejection of lodged specimens
- Available in boxes of 25
- Color-coded by size - 5 sizes available

Catalog#	Size
33-31AA-P/25	1.0 mm w/plunger
33-31A-P/25	1.5 mm w/plunger
<b>33-31-P/25</b>	<b>2.0 mm w/plunger</b>
33-32-P/25	3.0 mm w/plunger
33-34-P/25	4.0 mm w/plunger

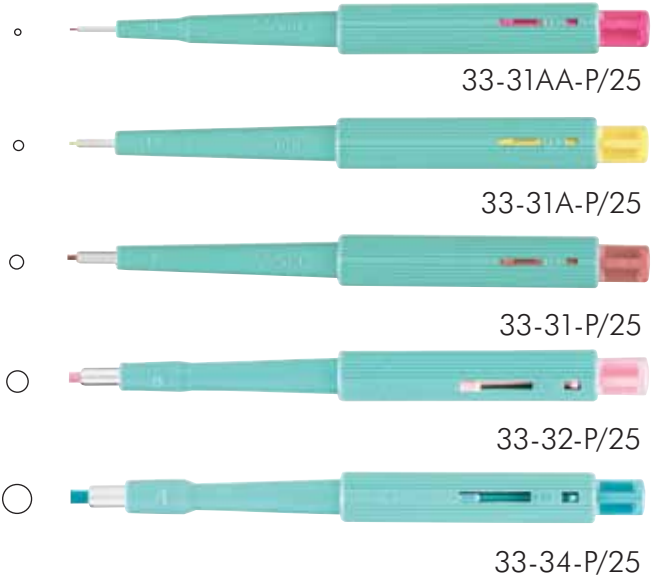

## Biopsy Punch, Standard

- Each dispenser box contains 50 punches
- Ten sizes for a wide range of applications
- Assortment box contains 10 each of the following sizes: 2 mm, 3 mm, 4 mm, 5 mm, and 6 mm

Catalog#	Size
33-31AA	1.0 mm
33-31A	1.5 mm
<b>33-31</b>	<b>2.0 mm</b>
33-31B	2.5 mm
<b>33-32</b>	<b>3.0 mm</b>
33-33	3.5 mm
<b>33-34</b>	<b>4.0 mm</b>
33-35	5.0 mm
<b>33-36</b>	<b>6.0 mm</b>
33-37	8.0 mm
33-38	Assorted sizes*

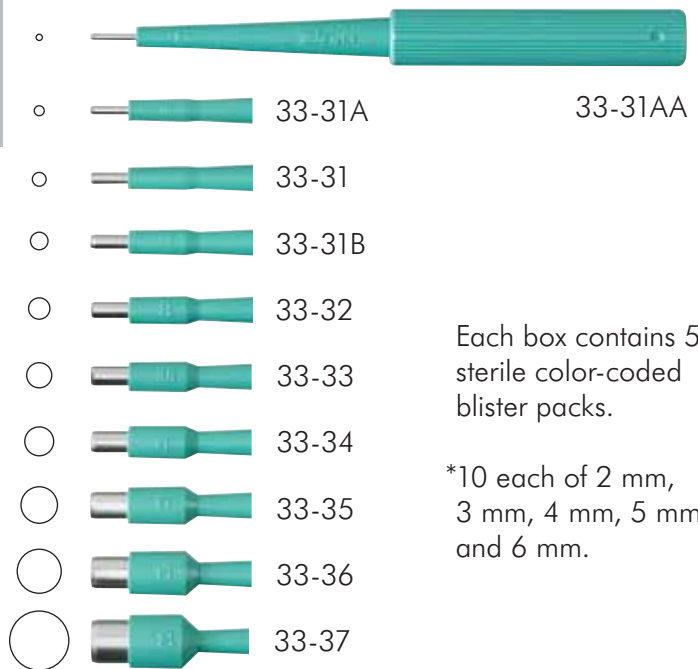

Each box contains 50 sterile color-coded blister packs.

\*10 each of 2 mm, 3 mm, 4 mm, 5 mm, and 6 mm.

Items in **Bold** represent most popular patterns





## Miltex BiopBlade®, Sterile

- Ideal for skin/tissue saucerization and shave biopsy
- Used in dermatology, podiatry, family practice and plastic surgery
- Incorporates a super sharp blade with rear finger guard
- Flexible design allows the blade to be positioned at any angle for the intended procedure
- Disposable, one-time use only
- Sterile, 5-year shelf life



Catalog#	Description
----------	-------------

33-100	Bx/50
--------	-------

## Dermal Curettes, Sterile

- Seamless, stainless steel, semi-sharp cutting edge featuring a unique symmetrically ground beveled edge
- Textured handle provides better comfort and control
- Sterile, 5-year shelf life
- Individually packaged in peel-apart pouches
- Convenience of disposables, single-use
- Sizes clearly marked on each curette
- Each dispenser box contains 50 curettes
- Five sizes available for a wide range of applications

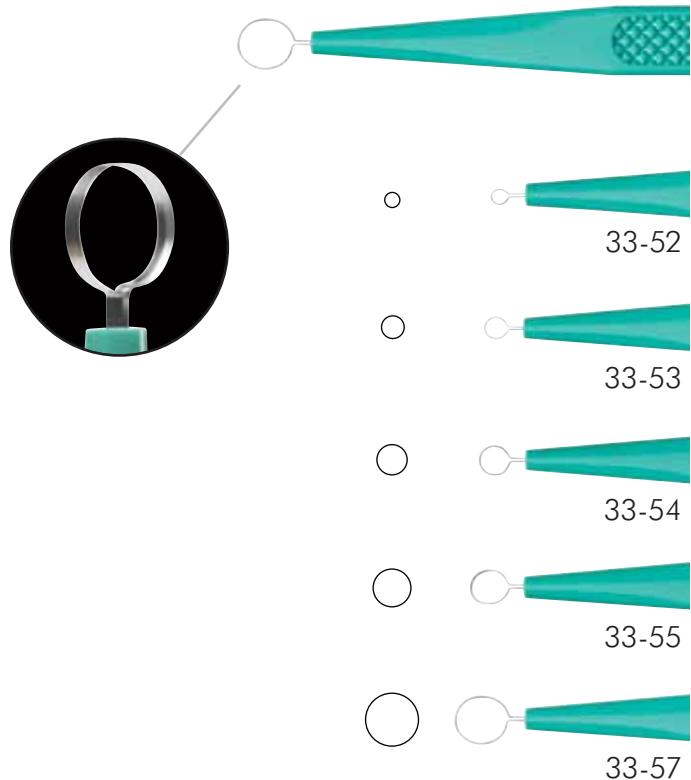

Catalog#	Size
----------	------

33-52	2.0 mm
33-53	3.0 mm
33-54	4.0 mm
33-55	5.0 mm
33-57	7.0 mm

## Safety Scalpels, Sterile

- Complies with OSHA directive for the Needlestick Safety & Prevention Act
- Stainless steel, razor-sharp cutting edge for superior cutting and clean incisions
- Pre-assembled, fully retractable scalpel blade is user activated
- Sterile, 5-year shelf life
- Individually packaged in sealed peel-apart pouches
- Convenience of disposables, single-use
- Metric ruler on each scalpel to assist in determining incision length
- Sizes clearly marked on each scalpel blade
- Each dispenser box contains 10 safety scalpels
- Six sizes available



4-510



4-511



4-515



4-515C



4-512



4-522

Catalog#	Size
<b>4-510</b>	<b>10</b>
<b>4-511</b>	<b>11</b>
4-512	12
<b>4-515</b>	<b>15</b>
4-515C	15C Angled Blade
4-522	22

## Directions For Use

Gently push slider to right and completely forward in one simple motion. Blade locks into place with audible confirmation. To retract, push slider to right and back to return blade to original protected position.

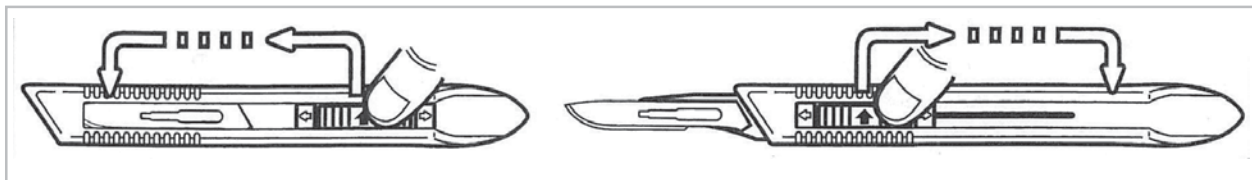

Items in **Bold** represent most popular patterns

## Scalpels, Standard, Sterile

- Stainless steel, razor-sharp cutting edge for superior cutting and clean incisions
- Safety sleeve for blade protects you and the blade
- Sterile, 5-year shelf life
- Individually packaged in sealed peel-apart pouches
- Convenience of disposables, single-use
- Sizes clearly marked on each scalpel blade
- Each dispenser box contains 10 scalpels
- Eight sizes available

Catalog#	Size
4-410	10
4-411	11
4-412	12
<b>4-415</b>	<b>15</b>
4-420	20
4-421	21
4-422	22
4-423	23



4-410



4-411



4-412



4-415



4-420



4-421



4-422



4-423

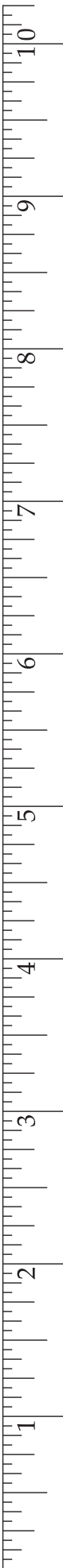

Items in **Bold** represent most popular patterns

## Surgical Blades, Sterile

### Carbon, Stainless Steel or Silicone Coated

- Razor-sharp cutting edge for superior cutting and clean incisions
- Sterile, 5-year shelf life
- Individually packaged in foil peel packs
- Convenience of disposables, single-use
- Sizes clearly marked on each blade
- Available in carbon, stainless steel and silicone coated
- Each dispenser box contains 100 blades

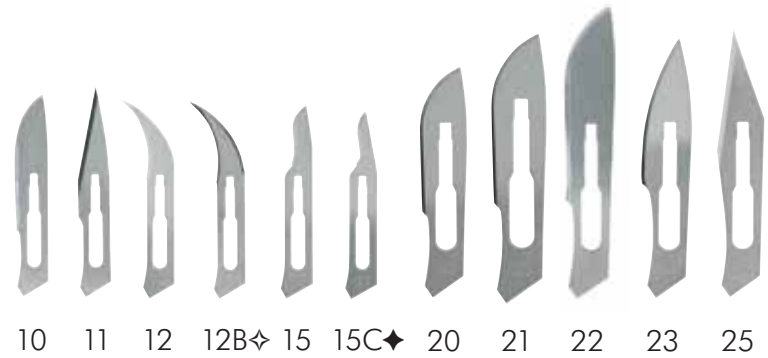

CS*	SS**	SC***	Size
Catalog#	Catalog#	Catalog#	
4-110	4-310	4610	10
4-111	4-311	4611	11
4-112	4-312	-	12
4-112B	4-312B	-	12B
4-115	4-315	4615	15
4-115C	4-315C	-	15C
4-120	4-320	-	20
4-121	4-321	-	21
4-122	4-322	-	22
4-123	4-323	-	23
4-125	4-325	-	25

\*Carbon Steel \*\* Stainless Steel \*\*\*Silicone Coated

◇B is a double edged blade

◆C is an angled blade

For your convenience, Miltex offers a wide array of scalpel blade handles and the Miltex® Blade-Safe Remover to aid in the safe removal of blades and to help protect against accidental cuts and punctures.

## Surgical Blade-Safe, Surgical Blade Remover

Catalog#	Description
4-100	Blade-Safe Surgical Blade Remover For Any Style Handle



4-100

## Surgical Instruments, Floor Grade Quality, Sterile Single-Use Instruments

- Convenience and cost savings provide an exceptional value
- Eliminate the time and expense of re-processing soiled instruments
- Includes all of the most common instrument patterns for routine surgical needs
- Sterile, 2-year shelf life



### Scissors

Catalog#	Description	Qty
ST5-120	MAYO, 5-1/2", Straight, B/B	50/Bx
ST5-124	MAYO, 6-3/4", Straight, B/B	50/Bx
ST5-16	OR Scissors, 5-1/2", Straight, S/B	50/Bx
ST5-180	METZENBAUM, 5-1/2", Curved	50/Bx
ST5-182	METZENBAUM, 7", Curved	50/Bx
ST5-304	IRIS Scissors, 4-1/2", Straight	50/Bx
ST5-306	IRIS Scissors, 4-1/2", Curved	50/Bx
ST5-504SS	LISTER Bandage Scissors, 5-1/2"	50/Bx
ST9-102	LITTAUER Stitch Scissors, 4-1/2"	50/Bx



ST5-124



ST5-304



ST5-504SS

### Forceps & Hemostats

Catalog#	Description	Qty
ST6-118	ADSON Forceps, 4-3/4"	50/Bx
ST6-120	ADSON Forceps, 4-3/4", 1X2	50/Bx
ST6-44	TISSUE Forceps, 5-1/2", 1X2	50/Bx
ST6-8	DRESSING Forceps, 5-1/2"	50/Bx
ST7-138	ROCHESTER-PEAN, 6-1/4", Curved	50/Bx
ST7-2	HALSTED Forceps, 5", Straight	50/Bx
ST7-4	HALSTED Forceps, 5", Curved	50/Bx
ST7-36	KELLY Forceps, 5-1/2", Straight	50/Bx
ST7-38	KELLY Forceps, 5-1/2", Curved	50/Bx
ST7-42	CRILE Forceps, 5-1/2", Straight	50/Bx
ST7-44	CRILE Forceps, 5-1/2", Curved	50/Bx



ST6-118

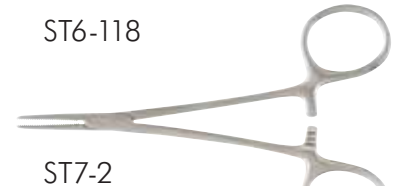

ST7-2

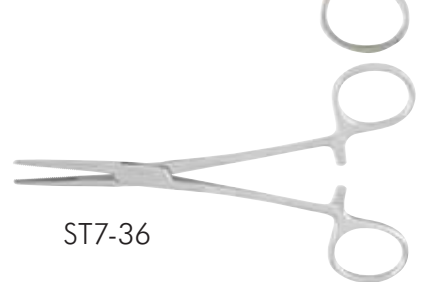

ST7-36

### Needle Holders

Catalog#	Description	Qty
ST8-44	MAYO-HEGAR Needle Holder, 6"	50/Bx
ST8-50	CRILE-WOOD Needle Holder, 6"	50/Bx
ST8-6	WEBSTER Needle Holder, 5"	50/Bx

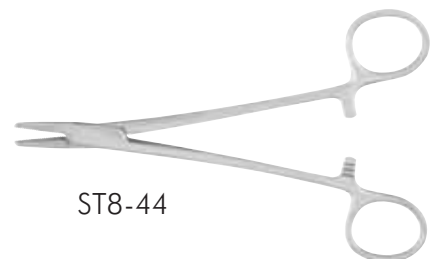

ST8-44

### Surgi-Clamp, Plastic

- Non-sterile operatory clamp
- Multi-functional
- Steam sterilization safe
- Designed for reuse
- No rust or stain problems

Catalog#	Description	Qty
374201	Surgi-Clamp, Plastic	100/bx



374201

### Surgi-Brush, Sterile

- Sterile brush used for cleaning surgical instruments (in the OR)
- Double-ended nylon bristle brush
- One end has 3 rows of bristles for general decontamination
- One end contains a single row of bristles for fine, delicate cleaning
- Disposable, one-time use only
- Sterile, 1-year shelf life

Catalog#	Description	Qty
405043	Surgi-Brush, Sterile	20/bx



405043

### Ear Curettes, Disposable

- Each curette is individually wrapped, non-sterile
- Available in boxes of 50
- Color-coded and available in 4 tip configurations

Catalog#	Description
19-320	Ring Tip, Pink
19-321	Loop Tip, White
19-322	Spoon Tip, Gray
19-323	Large Spoon Tip, Peach



19-320



19-321



19-322



19-323

### Nasostat® Treatment of Epistaxis

- Nasostat® products may be used in conjunction with anterior packing
- Will control bleeding while minimizing patient discomfort associated with nasal packs
- A safe and easily tolerated alternative to other treatments for epistaxis, e.g. cautery
- Sterile, 1-year shelf life

Catalog#	Description	Qty
41900	Nasostat Regular, Sterile	5/Bx
41901	Nasostat Slimline, Sterile	5/Bx
41902	Nasostat Large, Sterile	5/Bx
41903	Nasostat Small, Sterile	5/Bx



41900

## ENT Packing Line

The Miltex® ENT Packing line is a full offering of Polyvinyl Alcohol dressings for nasal, sinus and ear surgeries. The soft pre-compressed micro-pore size material allows for quick insertion and atraumatic removal for patient comfort. The Miltex® ENT Packing line is 100% lint and fiber free, easily trimmed for a custom fit and most products are available with a drawstring for patient safety.

### Features

- Hydrophilic and fast wicking
- Absorbs up to 25 times its weight in fluid
- Supplied compressed for easier insertion
- Disposable, one-time use only
- Sterile, 4-year shelf life

## Ear Packing

- Excellent wicking capabilities for administering otic medication in the treatment of Swimmer's Ear and other post-otic surgery.
- Fits into swollen ear canal and continually expands during healing process; helps provide contact and medication delivery to the infection site.

Catalog#	Description
----------	-------------

19-2000*	Short Otitis Externa Wick (9 mm x 15 mm), (1/pkt - 50 pkts/box)
19-2002*	Long Otitis Externa Wick (9 mm x 24 mm), (1/pkt - 10 pkts/box)
19-2004*	Ear Packing w/String (12 mm x 15 mm), (1/pkt - 10 pkts/box)



19-2000



19-2002



19-2004

\*Miltex® Brand

## Epistaxis

- Highly absorbent and effective control of epistaxis
- Inserts in seconds vs. traditional gauze packing method requiring 4 to 6 feet of gauze.
- Removal is easy and atraumatic.

Catalog#	Description
----------	-------------

20-3020*	Small Epistaxis Dressing w/String, (55 mm x 15 mm x 25 mm), (1/pkt - 20 pkts/box)
20-3022*	Large Epistaxis Dressing w/String, (100 mm x 15 mm x 25 mm), (1/pkt - 10 pkts/box)



20-3020



20-3022

\*Miltex® Brand

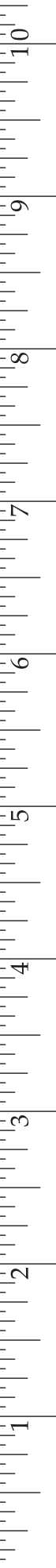



## Nasal

- Nasal products can be used for absorption and drainage for Rhinoplasty, Septoplasty and other nasal post-operative procedures.
- Non-stick skinned surface on dressing helps with atraumatic removal and minimizes re-bleeding.
- Dressings with airway (cannulated) tubes help ensure patient comfort.

Catalog#	Description
----------	-------------

20-3000*	Small Standard Nasal Dressing w/String (45 mm x 15 mm x 20 mm), (1/pkt - 10 pkts/box)
20-3002*	Small Standard Nasal Dressing with Airway Tube and String (45 mm x 15 mm x 20 mm), (1/pkt - 10 pkts/box)
20-3004*	Large Standard Nasal Dressing w/String (80 mm x 15 mm x 20 mm), (1/pkt - 10 pkts/box)
20-3006*	Large Standard Nasal Dressing with Airway Tube and String (80 mm x 15 mm x 20 mm), (1/pkt - 10 pkts/box)
20-3010*	Thin Anatomical Nasal Dressing w/String (80 mm x 7.5 mm x 30 mm), (1/pkt - 10 pkts/box)
20-3012*	Standard Anatomical Nasal Dressing w/String (80 mm x 15 mm x 30 mm), (1/pkt - 10 pkts/box)
20-3014*	Standard Anatomical Nasal Dressing with Airway Tube and String (80 mm x 15 mm x 30 mm), (1/pkt - 10 pkts/box)

\*Miltex® Brand



20-3000



20-3002



20-3004



20-3006



20-3010



20-3012



20-3014



## Sinus

- Designed to prevent lateralization of the middle turbinate after Functional Endoscopic Sinus Surgery.
- Compressed configuration for easy small cavity placement.
- Absorbs post-operative drainage and helps clear clots and debris upon removal, leaving a clean cavity.

Catalog#	Description
20-3030*	Sinus Dressing B-Type w/String (25 mm x 9 mm x 20 mm), (2/pkt - 10 pkts/box)
20-3032*	Sinus Dressing K-Type w/String (35 mm x 9 mm x 12 mm), (2/pkt - 10 pkts/box)
20-3034*	Sinus Dressing T-Type w/String (45 mm x 9 mm x 20 mm), (2/pkt - 10 pkts/box)
20-3036*	Slim Sinus Dressing B-Type w/String (25 mm x 6 mm x 20 mm), (2/pkt - 10 pkts/box)
20-3038*	Slim Sinus Dressing K-Type w/String (35 mm x 6 mm x 12 mm), (2/pkt - 10 pkts/box)
20-3040*	Slim Sinus Dressing T-Type w/String (45 mm x 6 mm x 12 mm), (2/pkt - 10 pkts/box)
20-3042*	Sinus Dressing Kit - Assortment of Sinus Dressing, Nasal Dressing/Airway Tube, (1/pkt - 10 pkts/box)

\*Miltex® Brand



20-3030



20-3032

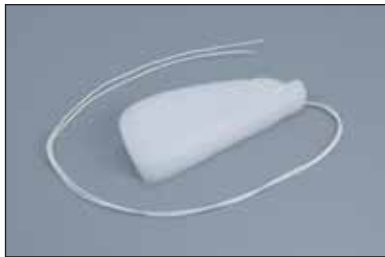

20-3034



20-3036



20-3038



20-3040



20-3042

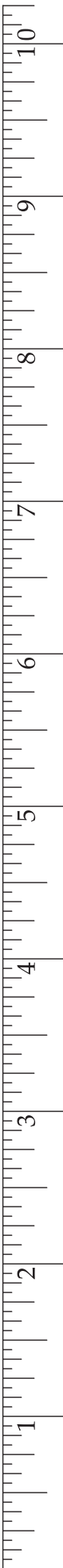

# STAINLESS STEELWARE AND INSTRUMENT STRINGERS





**Sponge Bowls**

Catalog#	Size
<b>3-900</b>	<b>4-5/16" x 2-13/64" (12 oz)</b>
3-901	4-1/4" x 2" (16 oz)
<b>3-902</b>	<b>5-5/8" x 2-9/32" (22 oz)</b>
3-903	6-27/64" x 2-1/4" (30 oz)
3-904	6-27/64" x 2-3/4" (36 oz)
3-905	7-9/16" x 3-3/16" (47 oz)
3-906	8-3/16" x 3-5/16" (64 oz)

**Iodine & Medicine Cups**

Catalog#	Description	Size
<b>3-912</b>	<b>Iodine Cup</b>	<b>3-5/16" x 2" (6 oz)</b>
3-913	Iodine Cup	5-1/32" x 2-23/64" (14 oz)
<b>3-914</b>	<b>Medicine Cup, Graduated</b>	<b>2-5/32" x 2-5/32" (2 oz)</b>



**Tumbler**

Catalog#	Size
3-907	2-7/8 x 3-1/8 (7 oz)

**Solution Basins**

Catalog#	Size
3-908	12-33/64" x 3-35/64" (4-1/2 qt)
3-909	13-25/32" x 4-17/32" (6 qt)
<b>3-910</b>	<b>13-25/32" x 4-59/64" (7 qt)</b>

Items in **bold** represent the most popular patterns.

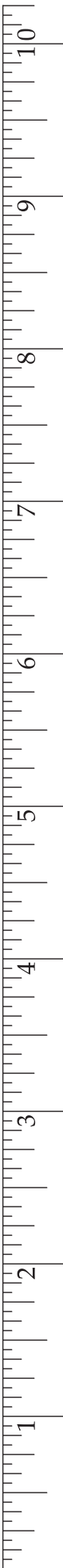



### Forceps Jars

Catalog#	Size
3-915	1-19/64" x 3-5/32"
3-916	2-3/16" x 4-21/64"
3-917	2-3/16" x 7-5/64"



### Dressing Jars with Covers

Cover included with jar

Catalog#	Size
3-953	4" x 2-5/8" (1/2 qt)
3-954	5" x 6-3/8" (2 qt)
3-955	5-7/8" x 7-5/64" (3 qt)



### Emesis Basins

Catalog#	Size
3-918	7-7/8" x 3-3/4" x 1-19/64" (10 oz)
3-919	8-5/32" x 3-55/64" x 1-17/32" (12 oz)
3-920	9-23/32" x 4-51/64" x 1-11/16" (20 oz)



### Instrument Trays

Catalog#	Size
3-934	10" x 6-1/2" x 23/32", rolled edge
3-935	14" x 10" x 5/8", rolled edge
3-936	21-11/32" x 16-7/16" x 7/8", rolled edge



### Perforated Mayo Trays

Catalog#	Size
3-921	10" x 6-1/2" x 23/32"
3-922	14" x 10" x 5/8"
3-924	17" x 11-5/8" x 3/4"
3-925	19-11/64" x 12-23/32" x 33/64"



### Non-Perforated Mayo Trays

Catalog#	Size
3-926	10" x 6-1/2" x 23/32"
3-927	14" x 10" x 5/8"
3-929	17" x 11-5/8" x 3/4"
3-930	19-11/64" x 12-23/32" x 33/64"

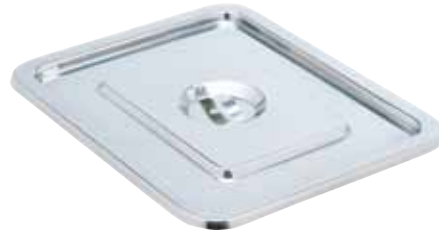

**Instrument Trays & Covers** cover sold separately

Catalog#	Description	Size
3-945	Instrument Tray, 12, 2-1/2, Solid	12-23/32" x 10-27/64" x 2-1/2"
3-946	Instrument Tray, 12, 3-3/4, Solid	12-23/32" x 10-27/64" x 3-3/4"
3-947	Flat Cover, 12, For 3-945 & 3-946	12-29/32" x 10-35/64" x 7/16"
<b>3-948</b>	<b>Instrument Tray, 10, 1, Solid</b>	<b>10-25/64" x 6-49/64" x 1-27/32"</b>
3-949	Flat Cover, 10, For 3-948	10-15/32" x 6-61/64" x 7/16"



**Cath Trays & Covers** cover sold separately

Catalog#	Description	Size
<b>3-937</b>	<b>Cath Tray, 8 x 5 x 1</b>	<b>8-25/32" x 4-61/64" x 1-49/64"</b>
3-938	Cath Tray, 8-7/8 x 5 x 3	8-7/8" x 5" x 3"
3-939	Flat Cath Cover, 8, Cover For REF 3-937 & 3-938	8" x 5" x 7/16"
3-940	Dome Cath Cover, 8, Cover For REF 3-937 & 3-938	8" x 5" x 7/16"
3-941	Cath Tray, 8 x 3 x 1-1/2, Narrow	8-35/64" x 3-5/64" x 1-1/2"
3-942	Dome Cath Cover, 8, Narrow, Cover For REF 3-941	8-21/32" x 3-5/16" x 19/32"
3-943	Cath Tray, 15-3/4 x 2-3/4 x 2, Long	15-3/4" x 2-3/4" x 2"
3-944	Dome Cath Cover, 15, Long, For REF 3-943	15-13/16" x 3-1/32" x 29/32"

Items in **bold** represent the most popular patterns.

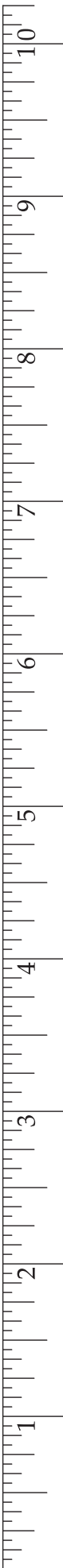



**Instrument Stringers**

<b>Catalog#</b>	<b>Description</b>	<b>Size</b>
3-70*	Stringer - Side Lock, Wide	2-1/2" x 8"
3-71*	Stringer - Side Lock, Wide	2-1/2" x 10"
3-72*	Stringer - Side Lock, Wide	2-1/2" x 12"
3-74*	Stringer - Side Lock, Wide	2-1/2" x 16"
3-75*	Stringer - Side Lock	2-1/2" x 6"
3-76*	Stringer - Side Lock	2-1/2" x 8"
3-77*	Stringer - Side Lock	2-1/2" x 10"
3-78*	Stringer - Side Lock	2-1/2" x 12"
3-79*	Stringer - Side Lock	2-1/2" x 16"
3-80*	Stringer - Side Lock	2-1/2" x 18"
3-81*	Stringer - Side Lock	5" x 8"
<b>3-82*</b>	<b>Stringer - Side Lock</b>	<b>5" x 10"</b>
3-83*	Stringer - Side Lock	5" x 12"
3-84*	Stringer - Side Lock	5" x 16"
3-85*	Stringer - Side Lock	5" x 18"
3-86*	Stringer - Open U	2-1/2" x 6"
3-87*	Stringer - Open U	2-1/2" x 8"
3-88*	Stringer - Open U	2-1/2" x 10"
3-89*	Stringer - Open U	2-1/2" x 12"
<b>3-90*</b>	<b>Stringer - Center Lock</b>	<b>2-1/2" x 6"</b>
3-91*	Stringer - Center Lock	2-1/2" x 8"
3-92*	Stringer - Center Lock	2-1/2" x 10"
<b>3-93*</b>	<b>Stringer - Center Lock</b>	<b>2-1/2" x 12"</b>
<b>3-94*</b>	<b>Stringer - Center Lock</b>	<b>2-1/2" x 16"</b>
<b>3-95*</b>	<b>Stringer - Center Lock</b>	<b>2-1/2" x 18"</b>
3-96*	Stringer - Closed U	2-1/2" x 6"
3-97*	Stringer - Closed U	2-1/2" x 8"
3-98*	Stringer - Closed U	2-1/2" x 10"
3-99*	Stringer - Closed U	2-1/2" x 12"



3-70 to 3-74



3-75 to 3-80



3-81 to 3-85



3-86 to 3-89



3-90 to 3-95



3-96 to 3-99

Items in **bold** represent the most popular patterns.

\*Miltex® Brand



# **INSTRUMENT MAINTENANCE AND CARE**



**Care & Cleaning Products  
Sterilization Accessories  
Cassettes & Mats  
Stringers  
Maintenance & Care  
Warranty**



## Miltex® Instrument Care & Cleaning Products

The MILTEX® care and cleaning product portfolio is designed to provide optimum cleaning performance and will help to prolong the service life of valuable surgical instrumentation.

### Miltex® Instrument Prep Enzyme Foam

Ready-to-use foaming spray for pre-cleaning of soiled instruments and scopes (rigid or flexible). Ideal for applications where instrument cleaning is not immediately available. Simply spray on instruments until ready for decontamination and cleaning.

Catalog#	Description
----------	-------------

3-760	24 oz. (0.71 liter) spray bottles (case of 12)*
-------	---



3-760

### Miltex® EZ-Zyme® All Purpose Enzyme Cleaner

Ideal for cleaning hard to remove proteinaceous (mucus & tissue) and lipid (fatty) materials from the surfaces of surgical and dental instruments, linen, water submersible equipment, or where mechanical scrubbing is impractical.

- *Easy to Use*
- *Neutral pH*
- *Multi-use as an instrument presoak, ultrasonic cleaner, laundry presoak and evacuation system cleaner*
- *Space-saving or bulk packaging options*

Catalog#	Description
----------	-------------

3-750	3/4 oz. (22 ml) packets (dispenser box of 32) Contents of 1-box makes 32 gallons of solution
3-755	1-gallon bottle (3.79 liter) Contents of 1-gallon container makes 170 gallons of solution



3-755

3-750

### Miltex® Surgical Instrument Cleaner

Super concentrate formula for manual and ultrasonic cleaning or soaking of surgical instruments, accessories and glassware.

- *Biodegradable*
- *Neutral pH*
- *Rinses free, leaves no residue*
- *Phosphate-free*
- *Concentrated*

Catalog#	Description
----------	-------------

3-720	8 fl. oz. (0.24 liter) bottles (case of 12)* Contents of one 8 oz. bottle makes 32 gallons of solution
3-725	1-gallon bottle (3.79 liter) Contents of 1-gallon container makes 512 gallons of solution



3-725

3-720

\*(Contact Distributor for availability of individual units)



## Miltex® Surgical Instrument Cleaner & Lubricant

A dual-purpose instrument cleaner and lubricant. Chemically engineered for use as a presoak or for manual cleaning, washer/decontaminators, ultrasonic cleaners and cart washers.

- *Cleaner & Brighter Instruments*
- *Removes Stains, Blood and Mineral Deposits*
- *Biodegradable*
- *Concentrate, Lower Cost Per Use*

Catalog#	Description
----------	-------------

3-710	1 Gallon (128 fl. oz.) 3.79L (see label for concentration rates)
-------	--



3-710

## Miltex® Instrument Lubricant

A water emulsible soaking agent works to extend the life of surgical instruments. Concentrated non-silicone lubricant and rust inhibitor. Use daily to keep moving parts operating smoothly.

- *Formulated to extend the working life of surgical instruments*
- *Helps Prevent Corrosion*
- *Formulated with gentle, non-aggressive ingredients*
- *Frees Up Box Locks - Lubricates moving parts of surgical instruments*

Catalog#	Description
----------	-------------

3-705	1 Gallon (128 fl. oz.) 3.79L (see label for concentration rates)
-------	--



3-705

## Miltex® Spray Lube (Surgical Instrument Lubricant)

Pre-mixed, non-silicone and anti-corrosive formula in a ready to use 8 oz. spray pump bottle. Steam permeable and water soluble. Helps prevent spotting, staining and rusting. Lubricates instrument box locks, screw locks, scissors blades and any other metal on metal moving parts.

Catalog#	Description
----------	-------------

3-700	8 fl. oz. (0.24 liter) bottles (case of 12)*
-------	--



3-700

\*(Contact Distributor for availability of individual units)

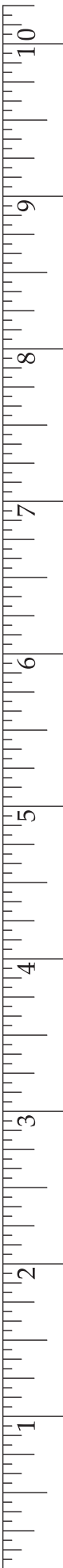

## Miltex® Surgical Instrument Stain Remover

Powder formula removes stains, tarnish and restores luster to surgical instruments, autoclaves, ultrasonic cleaners, stainless steel countertops, etc. Ideal for use on stainless steel, chrome, nickel, brass, copper and silver.

- *Effective on instruments, autoclaves, ultrasonic cleaners or any stainless steel, tile or plated surface*
- *Will not harm instrument surfaces*
- *Easy, fast, convenient to use*
- *Economical - a little goes a long way*



3-740

Catalog#	Description
----------	-------------

3-740	3 oz. (85 grams), (case of 12)*
-------	---------------------------------

## Miltex® Nylon & Stainless Steel Brushes

- *Nylon bristles for effective cleaning of instrument box locks*
- *Stainless steel bristles for cleaning serrations*
- *Autoclavable*

Catalog#	Description	Length
----------	-------------	--------

3-1000	Nylon Bristles (Set of 3)	7-1/4" (184 mm)
3-1001	Stainless Steel Bristles (Set of 3)	7-1/4" (184 mm)
21-379	Stainless Wire Brush	6-1/4" (159 mm)
405043	Surgi-Brush, Sterile 20/box	6-1/4" (159 mm)



3-1000

3-1001

21-379

405043

## Miltex® Instrument Care Kit System

A great way to try various MILTEX® products!

Catalog#	Description
----------	-------------

3-800	Spray Lube (3-700), Surgical Instrument Cleaner (3-720), Surgical Instrument Stain Remover (3-740), Instrument Care DVD (3-810), Nylon Brush and Stainless Steel Brush
-------	--



3-800

\*(Contact Distributor for availability of individual units)



## Silitone™ Color Bands

Silitone™ color bands are made from medical-grade silicone and can withstand temperatures up to 450° F. Silitone™ bands are expandable from 4 mm to 12 mm and are available in a variety of colors. 50 pieces per pack except kits.

Catalog#	Description
----------	-------------

VSTSA	Grey - 50 pieces
VSTSB	Blue - 50 pieces
VSTSD	Gold - 50 pieces
VSTSG	Green - 50 pieces
VSTSK	Black - 50 pieces
VSTSL	Light Blue - 50 pieces
VSTSN	Brown - 50 pieces
VSTSP	Pink - 50 pieces
VSTSR	Red - 50 pieces
VSTSU	Purple - 50 pieces
VSTSW	White - 50 pieces
VSTSY	Yellow - 50 pieces
VST	Kit of 12 colors - 480 pieces (40 of each color)
VSTA	Kit of 12 colors - 120 pieces (10 of each color)

Will work with ring-handled instruments!



VST

(Exercise caution when applying color bands to instruments with sharp points.)

## Tape N' Tell™ Adhesive Strips

The Tape N' Tell™ adhesive strips are ideal for color coding instruments and procedural kits.

Catalog#	Description
----------	-------------

017-48220	TAPE N' TELL WHITE
017-48221	TAPE N' TELL YELLOW
017-48222	TAPE N' TELL RED
017-48223	TAPE N' TELL BLUE
017-48224	TAPE N' TELL GREEN
017-48225	TAPE N' TELL BLACK
017-48226	TAPE N' TELL ORANGE
017-48227	TAPE N' TELL BROWN
017-48230	TAPE N' TELL 8 ASSORTED



017-48230

## Tip-It™ Instrument Protectors

Tip-It™ Instrument Protectors guard instrument tips and edges from damage during handling and sterilization.

- PVC medical grade plastic
- Latex-free material
- Large holes (vented styles) to reduce vacuum and moisture build up for easy removal from instrument
- Steam and gas sterilizable
- 50 per pack

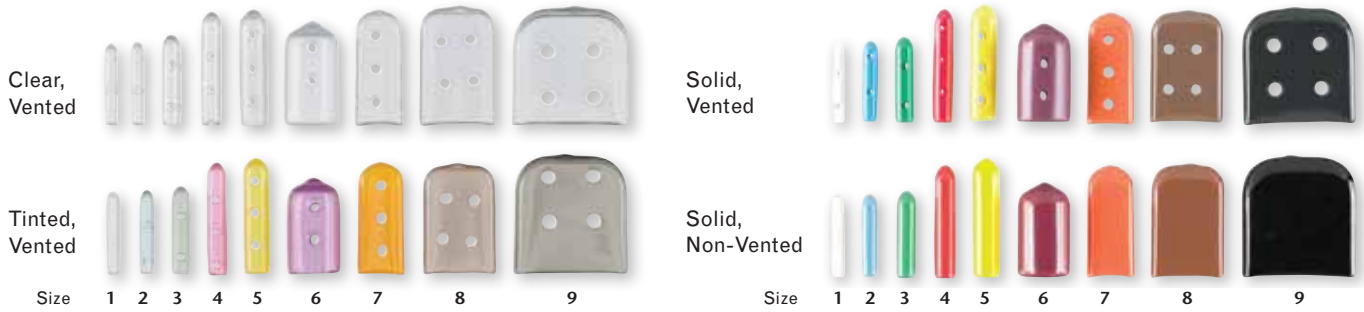

Catalog#	Catalog#	Catalog#	Catalog#		Size	Color
Clear Vented	Tinted Vented	Solid Vented	Solid Non-Vented		Code	
3-2501C	3-2501T	3-2501V	3-2501	1/16" x 3/4" (1.6 mm x 19 mm)	1	White*
3-2502C	3-2502T	3-2502V	3-2502	5/64" x 3/4" (2 mm x 19 mm)	2	Blue*
3-2503C	3-2503T	3-2503V	3-2503	7/64" x 3/4" (2.8 mm x 19 mm)	3	Green*
3-2504C	3-2504T	3-2504V	3-2504	1/8" x 1" (3.2 mm x 25.4 mm)	4	Red*
3-2505C	3-2505T	3-2505V	3-2505	3/16" x 1" (4.8 mm x 25.4 mm)	5	Yellow*
3-2506C	3-2506T	3-2506V	3-2506	13/32" x 3/4" (10.3 mm x 19 mm)	6	Maroon*
3-2507C	3-2507T	3-2507V	3-2507	1/16" x 3/8" x 1" (1.6 mm x 9.5 mm x 25.4 mm)	7	Orange*
3-2508C	3-2508T	3-2508V	3-2508	5/64" x 5/8" x 1" (2 mm x 16 mm x 25.4 mm)	8	Brown*
3-2509C	3-2509T	3-2509V	3-2509	1/8" x 1" x 1" (3.2 mm x 25.4 mm x 25.4 mm)	9	Black*
3-2510C	3-2510T	3-2510V	3-2510	Assorted, equal number of sizes plus 5	-	-

\* Color does not apply to clear vented pattern



## Miltex® Instrument Storage System featuring the "Tuck-Away™" Lid

### Universal Cassette without Mat

Catalog#	Size
4-6835	6-1/2 x 6-1/4 x 1-3/16
4-083000	8 x 3-13/16 x 1-3/16
4-084000	8 x 4-7/8 x 1-3/16
4-085000	8 x 6 x 1-3/16
4-089100	8 x 9 x 1-3/16
4-008122	8 x 11 x 1-3/16
4-008115	8 x 11 x 2
4-009126	9-1/8 x 13 x 1-3/16
4-6815	15 x 8-1/4 x 1-3/16

1. Unique flow-through design.
2. Medical grade silicone strip provides instrument retention when lid is closed.
3. Full length hinge provides stable and secure attachment to cassette.
4. Quick and easy push button release provides a positive lock when closed.
5. Pre-stamped tabs allow for custom coding of cassettes.
6. Double-hinged lid folds under cassette for easy storage during use.
7. Self-lubricating plastic hinge pin will not corrode and provides smooth mechanical movement.
8. Passivated stainless steel provides corrosion protection and an aesthetic finish.

### Slimline Series without Mat

Catalog#	Size
3-072007	7 x 2-5/8 x 11/16*
3-082008	8 x 2-5/8 x 11/16*
STDSL27	7 x 2-5/8 x 1*
3-072014	7 x 4-5/8 x 11/16*

\*Single-hinge design



### Latex-Free Silicone Mats (Mat Only)

Catalog#	Size	Description
4-6835MAT	6-1/2 x 6-1/4	for Cassette 4-6835
4-083000MAT	8 x 3-13/16	for Cassette 4-083000
4-084000MAT	8 x 4-7/8	for Cassette 4-084000
4-085000MAT	8 x 6	for Cassette 4-085000
4-089100MAT	8 x 9	for Cassette 4-089100
4-008122MAT	8 x 11	for Cassette 4-008122 & 4-008115
4-009126MAT	9-1/8 x 13	for Cassette 4-009126
4-6815MAT	15 x 8-1/4	for Cassette 4-6815

1. The raised mat (or feet) assures adhesion of the mat to the tray surface.
2. Holes positioned on mat for proper drainage.
3. Soft cushion fingers protect your instrument investment.
4. Customized to fit perfectly into Miltex® Cassettes.

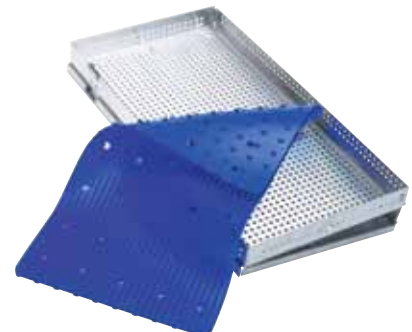

## Instrument Wrapper

Handy, reusable cloth wrap for storing and autoclaving instruments.

Catalog#	Description	Dimensions
PM-180	Small Size, Canvas Only	29 cm x 20 cm
PM-949	Medium Size, Canvas & Felt	45 cm x 40 cm
PM-950	Large Size, Canvas & Felt	90 cm x 40 cm

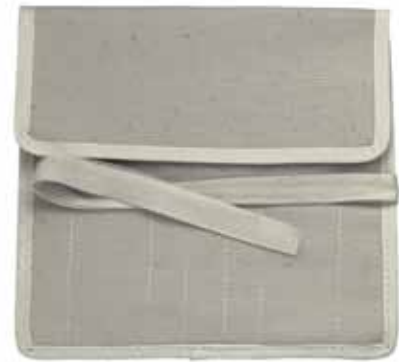

PM-180

## Small Plastic Tray (ideal for Nasal Tip Sizers)

Catalog#	Size
PM-9323	2-3/4" x 1-3/4" x 3/4" (73 mm x 44 mm x 19 mm)



PM-9323

## Microsurgical Plastic Trays

Durable lightweight trays made from high strength polymer. May be steam or ETO sterilized. Silicone mat fingers cradle and protect delicate instruments.

Catalog#	Description	Dimensions
PM-9325	With Silicone Mat	11" x 7" x 3/4" (279 mm x 178 mm x 9 mm)
PM-9326	With Silicone Mat	10" x 5-3/4" x 3/4" (254 mm x 146 mm x 19 mm)



PM-9325



PM-9326

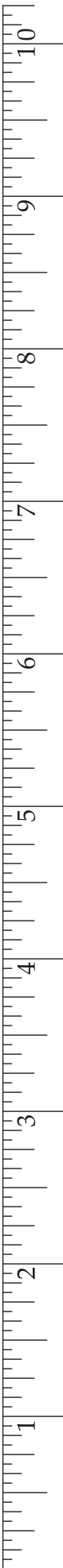

## Miltex® Sterilization Trays

Catalog#	Description	Dimensions
3-200100*	Single layer	7" x 11" x 1-1/2" H (178 mm x 279 mm x 38 mm)
3-200200*	Double layer	7" x 11" x 1-1/2" H (178 mm x 279 mm x 38 mm)
3-200300*	Single layer	4" x 8" x 3/4" (102 mm x 203 mm x 19 mm)



Each tray comes with a silicon mat that helps secure and protect instruments while in the tray.

The raised mat in each layer not only helps to protect instruments but also provides efficient ventilation to facilitate drying.



3-200200



3-200100



3-200300

\*Miltex® Brand





## Miltex® Sterilization Cases

- Double row of pins welded to bottom hold instruments in place
- Strips of silicone rubber cushions on bottom and cover give added protection to instruments.
- Perforated cover and bottom assure complete heat penetration with no build-up of condensation
- All edges rolled for safety
- Easily operated lock holds cover securely

Catalog#	Description	Dimensions
3-550*	With handles & removable cover	8" x 8-1/2" x 1-1/4" (203 mm x 216 mm x 32 mm)
3-552*	With handles & removable cover	8" x 12-1/4" x 1-1/4" (203 mm x 311 mm x 32 mm)
3-554*	With handles & removable cover	10-1/2" x 10" x 1-1/2" (267 mm x 254 mm x 38 mm)

\*Miltex® Brand



3-554

## Miltex® Sterilization Cases

- Same features as above, plus double rows of silicone rubber cushions on bottom adjustable to lengths of instruments

Catalog#	Description	Dimensions
3-570*	With handles & removable cover	8-1/2" x 8" x 1-1/4" (216 mm x 203 mm x 32 mm)
3-572*	With handles & removable cover	8-1/2" x 12" x 1-1/4" (216 mm x 305 mm x 32 mm)
3-574*	With handles & removable cover	10-1/2" x 10" x 1-1/2" (267 mm x 254 mm x 38 mm)
3-576*	With handles & removable cover	10-1/2" x 15" x 1-1/4" (267 mm x 382 mm x 32 mm)

\*Miltex® Brand

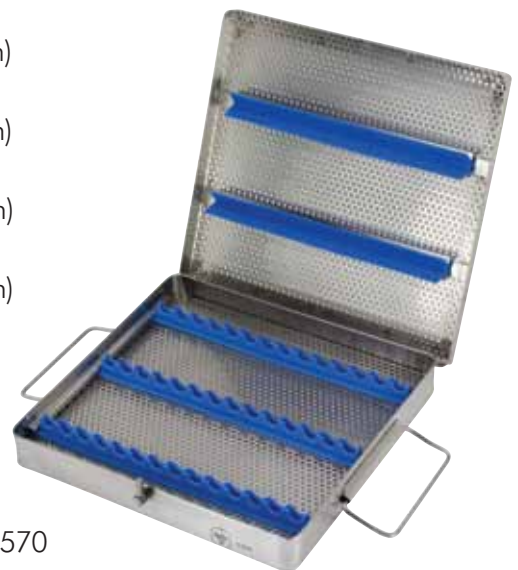

3-570

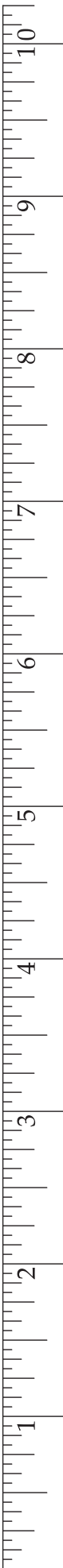

## Bunt Holder

**Catalog# Description**

3-60\* For Sterilizing Ring Handle Instruments

\*Miltex® Brand



3-60

## Padgett Rubber Magnetic Mat

**Catalog# Description Size**

PM-947 Blue, Autoclavable, Latex-Free 33 cm x 23 cm



PM-947



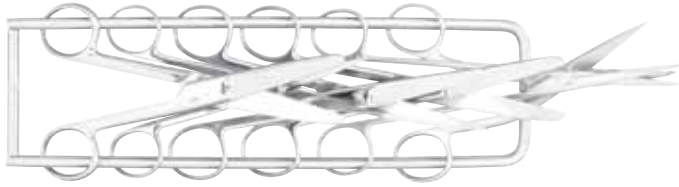

### Instrument Stringers

Catalog#	Description	Size
3-70*	Stringer - Side Lock, Wide	2-1/2" x 8"
3-71*	Stringer - Side Lock, Wide	2-1/2" x 10"
3-72*	Stringer - Side Lock, Wide	2-1/2" x 12"
3-74*	Stringer - Side Lock, Wide	2-1/2" x 16"
3-75*	Stringer - Side Lock	2-1/2" x 6"
3-76*	Stringer - Side Lock	2-1/2" x 8"
3-77*	Stringer - Side Lock	2-1/2" x 10"
3-78*	Stringer - Side Lock	2-1/2" x 12"
3-79*	Stringer - Side Lock	2-1/2" x 16"
3-80*	Stringer - Side Lock	2-1/2" x 18"
3-81*	Stringer - Side Lock	5" x 8"
<b>3-82*</b>	<b>Stringer - Side Lock</b>	<b>5" x 10"</b>
3-83*	Stringer - Side Lock	5" x 12"
3-84*	Stringer - Side Lock	5" x 16"
3-85*	Stringer - Side Lock	5" x 18"
3-86*	Stringer - Open U	2-1/2" x 6"
3-87*	Stringer - Open U	2-1/2" x 8"
3-88*	Stringer - Open U	2-1/2" x 10"
3-89*	Stringer - Open U	2-1/2" x 12"
<b>3-90*</b>	<b>Stringer - Center Lock</b>	<b>2-1/2" x 6"</b>
3-91*	Stringer - Center Lock	2-1/2" x 8"
3-92*	Stringer - Center Lock	2-1/2" x 10"
<b>3-93*</b>	<b>Stringer - Center Lock</b>	<b>2-1/2" x 12"</b>
<b>3-94*</b>	<b>Stringer - Center Lock</b>	<b>2-1/2" x 16"</b>
<b>3-95*</b>	<b>Stringer - Center Lock</b>	<b>2-1/2" x 18"</b>
3-96*	Stringer - Closed U	2-1/2" x 6"
3-97*	Stringer - Closed U	2-1/2" x 8"
3-98*	Stringer - Closed U	2-1/2" x 10"
3-99*	Stringer - Closed U	2-1/2" x 12"



3-70 to 3-74



3-75 to 3-80



3-81 to 3-85



3-86 to 3-89



3-90 to 3-95



3-96 to 3-99

\*Miltex® Brand

Items in **bold** represent the most popular patterns.

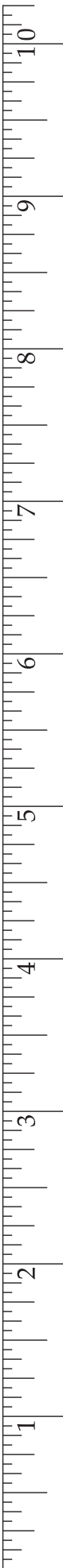

## Sterilization Products

Miltex offers a wide range of sterilization products which can be used in conjunction with the Universal cassettes.

### CSR Wrap

A suitable CSR wrap for steam, ETO gas and radiation sterilization processes. CSR wraps are electronically inspected for defects such as pin holes and are monitored for thickness consistency. CSR wraps are one of the lowest linting products available on the market.

Features include:

- Resists memory
- Allows faster steam penetration than muslin
- Repels water and OR fluids
- Low linting
- Meets established standards for tensile strength and tear resistance
- Excellent barrier to airborne bacteria
- Accepts sterilization tape and labels
- Biodegradable

Available in three sizes—15", 20", and 24" square

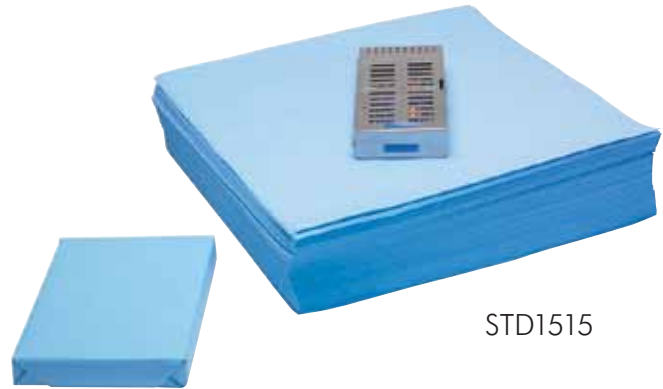

STD1515

Catalog#	Dimensions	Case quantity
----------	------------	---------------

STD1515	15" x 15"	1000/case
STD2020	20" x 20"	500/case
STD2424	24" x 24"	500/case

### Indicator Tapes

Used to visually identify processed from unprocessed packs. Miltex® Indicator Tapes are manufactured from a specially treated crêpe paper and are coated with a high performance, pressure-sensitive adhesive that will not come undone when subjected to wet or dry heat. Supplied in 60 yard rolls, Miltex® Indicator Tapes are available in steam, vapor and dry heat styles.

Features include:

- Adheres to any kind of material
- Distinctive color-change
- Accommodates pack expansion during sterilization
- Accepts labels and writing

Catalog#	Description
----------	-------------

STDSTEAM	3/4" Steam, 60 yd.
STDDRY	1" Dry Heat, 60 yd.



STDSTEAM



STDDRY

### Steam Indicator Strips

Per CDC guidelines, a chemical indicator should be used with each load in conjunction with routine spore testing. The Miltex® Steam Indicator Strip turns brown when sterilization conditions have been met and is certified for use with all steam sterilization processes. Packaged 250 strips per box, the Steam Indicator strips may be maintained as a permanent record of sterilization

Catalog#	Description
----------	-------------

STDIND	Steam Indicator Strips, 250/bx
--------	--------------------------------



STDIND

## Recommended Steps in Cleaning, Sterilization & Maintenance of Miltex® & Padgett® Surgical Instruments

### 1. HOLDING/PRESOAK

Never hold instruments in a dry container.

Doing so allows blood and debris to dry onto instrument surfaces and makes cleaning more difficult. If rinsing and decontamination processes are not immediately available, pre-treat instruments or hold them in a neutral pH holding/presoak enzymatic solution after patient use but before actual cleaning. Miltex® Instrument Prep Enzyme Foam (3-760) is a ready to use foaming spray for pre-cleaning soiled instruments and scopes. Simply spray the foam on instruments until they are ready for processing. Also, Miltex® EZ-Zyme® (3-750 and 3-755) neutral pH all purpose multi-enzyme concentrate is ideal for instrument presoaking and pre-cleaning. As soon as possible, rinse and clean as follows:

### 2. RINSING

(Always wear safety protection gear.)

Immediately after surgery, remove organic materials by rinsing instruments under warm (not hot) running water. Rinse should remove most blood, fluids and tissue. Do not process dissimilar metals (stainless, copper, chrome plated, etc.) together.

**Note:** *Disinfection can be included to protect medical personnel from contamination during cleaning; however, protection also can be accomplished by following standard precautions by wearing appropriate PPE as promulgated by OSHA & AORN.*

### 3. CLEANING

All blood, dried body fluids and tissue should be completely removed from instruments prior to sterilization. Several methods for removing these materials are available.

- A. **Soak:** An enzymatic cleaner bath (soak) such as Miltex® EZ-Zyme® (3-750 and 3-755) or a solution of water and neutral pH (7) detergent such as Miltex® Surgical Instrument Cleaner (3-720, 3-725 and 3-726) is effective in removing organic material from instruments. Use distilled (demineralized) water, if possible. Instruments should be fully submerged for at least 10 minutes. Do not let "sharps" (scissors, knives, osteotomes, etc.) touch each other. Ensure that dissimilar metal instruments are separated. Rinse instruments under running water to remove solutions and change solutions frequently.
- B. **Ultrasonic Cleaning:** Most instrument manufacturers recommend ultrasonic cleaning as the most effective way to clean surgical instruments, particularly instruments with hinges, box locks and other moving parts.
  - All instruments must be fully submerged in an open position using distilled (demineralized) water, if possible. To prevent possible surface scratching make sure that "sharps" do not touch other instruments. Also, separate instruments of dissimilar metals.
  - Process instruments for the full recommended ultrasonic cleaning cycle. Change solution frequently or as often as the manufacturer recommends.
  - Rinse instruments with water to remove the cleaning solution. Miltex® EZ-Zyme® (3-750 and 3-755) or Miltex® Surgical Instrument Cleaner (3-720, 3-725 and 3-726) can be safely used with all ultrasonic units.

C. **Automatic Washer Sterilizers:** Following manufacturers' recommendations, ensure that instruments are lubricated before the sterilization cycle and after the last rinse cycle.

**CAUTION:** Needle holders and forceps may crack if sterilized with ratchet in closed position.

D. **Manual Cleaning:** If ultrasonic cleaning is not available, observe the following steps:

- Use stiff nylon cleaning brushes (3-1000). Do not use steel wool or wire brushes except stainless steel wire brushes (3-1001) specially recommended for instrument serrated areas, bone files, burs or on stained areas of knurled handles.
- Use only neutral pH (7) detergents such as Miltex® Surgical Instrument Cleaner (3-720, 3-725 and 3-726). If not rinsed off properly, low pH (acidic - less than 6 pH) detergents break down the stainless protective surface resulting in pitting and/or black staining on instruments. High pH detergents (alkaline - more than 8 pH) can cause brown stains (phosphate surface deposit) which can also interfere with the smooth operation of instruments. Most brown stains are not rust and are easily removed with Miltex® Surgical Instrument Stain Remover (3-740).
- Brush delicate instruments carefully, and if possible, separate them from general instruments.
- Make sure instrument surfaces are visibly clean and are free from stains and tissue. Miltex® Surgical Instrument Stain Remover (3-740) can help remove residue stains. This is also a good time to inspect each instrument for proper function and condition.
- Check scissors' blades to ensure proper function. Blades should open and close smoothly. Test cutting performance at 3/4 length of the blade with the materials recommended below. Scissors should cut all the way to the tips. Recommended cutting test materials:
  - Fine/Delicate scissors: Surgical glove
  - Medium scissors: Single layer of stocking/cast netting
  - Large/Utility scissors: Double layer of stocking/cast netting
- Check forceps (pickups) for proper jaw alignment. Teeth must meet properly without catching.
- Check hemostats and needle holders to ensure jaw tips close in first ratchet position and that the entire jaw closes in third ratchet position. Check instruments for loose hinges and verify that they lock and unlock easily. Also check instruments for wear on jaw surfaces.
- Suction tubes should be clean inside.
- Test Biopsy Punches by punching a clean hole in 3-6 mil thick poly-bag material. If poly-bag material is not available, use tissue paper.
- Retractors should function properly.



# Recommended Steps in Cleaning, Sterilization & Maintenance of Miltex® & Padgett® Surgical Instruments

- Cutting edge instruments and knives should be sharp and free of damage.
- After scrubbing, rinse instruments thoroughly under running water. While rinsing, open and close scissors, hemostats, needle holders and other hinged instruments to ensure that hinged areas are rinsed out and that no debris remains.

## 4. AFTER CLEANING

Separate dissimilar metals prior to sterilizing/autoclaving. If instruments will be stored, allow them to air-dry and store them in a clean and dry environment.

## 5. AUTOCLAVING

- A. Lubricate all hinged instruments** which have any "metal to metal" action at the screw or box lock. A non-silicone, water-soluble surgical lubricant such as Miltex® Lube (3-700 or 3-705) is recommended. Do not use industrial oils or lubricants.
- B. Sterilize instruments** either individually or in sets.
- **Individual Instruments:** Disposable paper or plastic pouches are ideal. Make sure to use a wide enough pouch for instruments with ratchet locks so instruments can be sterilized in an open (unlocked) position. Instruments locked during autoclaving can develop cracked hinges (box locks) or other problems because of heat expansion. If wrapping instruments, make sure the towel does not contain detergent residue which can stain instruments.
  - **Instrument Sets:** Unlock all instruments and sterilize in an open position. Place heavy instruments on the bottom of set (when two layers are required). Do not overload the chamber because an air pocket that hinders steam penetration may form.

**CAUTION:** With most portable tabletop autoclaves, unlock the door and open it no more than a crack, about 1/4" (6.4 mm). (at the end of the autoclave cycle and before the drying cycle). Then run the dry cycle for the period recommended by the autoclave manufacturer. If the autoclave door is fully opened before the drying cycle, cold air will rush into the chamber and will cause condensation on the instruments, potentially resulting in water stains or causing wet packs. Make sure autoclave filters and chambers are cleaned as recommended by the manufacturer. Miltex® Surgical Instrument Stain Remover (3-740) is effective in removing stains and in cleaning the autoclave chamber. If you have any unusual staining on your instruments after sterilization, obtain our Instrument Care System DVD (3-810) or contact your local Miltex® representative.

## 6. CHEMICAL/COLD STERILIZATION

Most chemical/cold sterilization solutions render instruments sterile only after 10-hour immersion. This prolonged chemical action can be more detrimental to instruments than the usual 20-minute autoclave cycle. If the instruments need to be "disinfected" only, a chemical/cold sterilization soak is acceptable, as disinfection will take approximately 10 minutes or more. Check manufacturers' specifications. Also see our warning in using bleach (paragraph 3).

Keep in mind the difference between:

- Sterile - an absolute term (no living organism survives); and
- Disinfected - basically clean. Some organisms may survive. Always use the proper sterilization/cleaning technique to render the instrument in the required condition for use.

**CAUTION:** For instruments with tungsten carbide insert jaws, the use of chemical/cold sterilization solutions is not recommended as it may deteriorate the instrument's jaw.

**We recommend these Miltex products to properly safeguard and care for your quality instruments.**

REF	Description	Use During
3-760	Instrument Prep Enzyme Foam 24 oz. spray	• Holding & presoak
3-750	EZ-Zyme®, All Purpose Enzyme Cleaner Box 32 - 3/4 oz. packets	• Holding & presoak • Soak cleaning • Ultrasonic cleaning
3-755	EZ-Zyme®, All Purpose Enzyme Cleaner 1-gallon pump bottle	• Manual cleaning • Laundry presoak
3-700	Spray Lube 8 oz. spray bottle	• Before autoclaving
3-705	Surgical Instrument Lubricant 1-gallon pump bottle	
3-710	Surgical Instrument Cleaner & Lubricant 1-gallon pump bottle	• Manual cleaning • Washer/decontaminator • Ultrasonic cleaning
3-720	Surgical Instrument Cleaner 8 oz. spray bottle	• Soak cleaning • Ultrasonic cleaning • Manual cleaning
3-725	Surgical Instrument Cleaner 1-gallon pump bottle	
3-740	Surgical Instrument Stain Remover 3 oz. jar	• Stain removal
3-1000	Nylon Instrument Cleaning Brushes 3-pack	• Manual cleaning of instruments
3-1001	Stainless Steel Instrument Cleaning Brushes 3-pack	
3-800	Instrument Care System	• Complete instrument care
3-810	Instrument Care DVD	• Training personnel in the care of instruments



## Instrument Stain Guide

Color	Cause of Stain	What to do
Orange-Brown to Reddish stain (looks like rust)	<p>Perform eraser test. If the stain rubs off and no pitting exists, problem is most likely from:</p> <ul style="list-style-type: none"> <li>• Detergent residue on towels or high alkaline &gt;8 pH detergent which leaves a phosphate surface deposit</li> <li>• Dried blood</li> <li>• Iodine or Betadine residue</li> </ul>	<ul style="list-style-type: none"> <li>• Change to neutral pH detergent. We recommend Miltex® Surgical Instrument Cleaner.</li> <li>• Check pH of towels with litmus to verify if detergent residues are present.</li> <li>• Rinse the instruments in warm water for at least 30 seconds</li> <li>• Use a stain remover on both the instruments and autoclaves</li> <li>• If problem persists, consider changing to distilled or demineralized water, particularly if the local water supply is high in iron or other minerals.</li> </ul>
Black, Brown & Pitting	<p>Subjected to an Acidic Low &lt;6 pH substance such as:</p> <ul style="list-style-type: none"> <li>• Low pH detergent residues on instrument surface or from towels</li> <li>• Exposure to other chemical compounds from "cold soaking"</li> <li>• Exposure to bleach</li> </ul>	<ul style="list-style-type: none"> <li>• Change to neutral pH detergent. We recommend Miltex® Surgical Instrument Cleaner.</li> <li>• Check pH of towels with litmus to verify if detergent residues are present.</li> <li>• Eliminate exposure to chemicals or bleach</li> <li>• Rinse instruments thoroughly and consider using distilled or demineralized water, particularly if the local water supply is high in iron or other minerals.</li> <li>• Use stain remover on both the instruments and on autoclaves.</li> <li>• Eliminate any use of bleach.</li> <li>• If pitting remains, send the instrument back to the manufacturer for evaluation.</li> </ul>
Rainbow or Multi-Color	<ul style="list-style-type: none"> <li>• Heat compromised, tensile strength is compromised</li> </ul>	<ul style="list-style-type: none"> <li>• Check the autoclave for proper temperature.</li> </ul>
Bluish-Green Bluish-Black	<ul style="list-style-type: none"> <li>• Cross contamination between dissimilar metals</li> </ul>	<ul style="list-style-type: none"> <li>• Separate instruments by metal type before cleaning or autoclaving instruments.</li> </ul>
Bluish-Gray (w/possible pitting)	<ul style="list-style-type: none"> <li>• Improper preparation of cold sterilization solutions</li> </ul>	<ul style="list-style-type: none"> <li>• Follow solution manufacturer's directions closely, particularly temperature and soak times.</li> <li>• Use distilled or demineralized water.</li> <li>• Change solution per manufacturer's instructions.</li> </ul>
Rust	<ul style="list-style-type: none"> <li>• Sterilizing instruments of dissimilar metals in the same cycle.</li> <li>• Chemicals in detergents or excess amounts of iron or other minerals from local water supply.</li> <li>• New instruments may be slightly magnetized during the manufacturing process.</li> </ul>	<ul style="list-style-type: none"> <li>• Separate instruments by metal type prior to sterilization.</li> <li>• Use neutral pH detergents and change to distilled or demineralized water, particularly if the local water supply is known to contain iron or other minerals.</li> <li>• Wipe off as much residue as possible, leaving shiny metal underneath. Use a stain remover on both the instruments and autoclaves.</li> <li>• The instruments lose their magnetic property after several autoclaving sequences</li> </ul>
Spotting Light or Dark colored	<ul style="list-style-type: none"> <li>• Slow evaporation of water drops with mineral content</li> <li>• Instrument wraps and towels may contain detergent residue.</li> </ul>	<ul style="list-style-type: none"> <li>• Eliminate water droplets and moisture by adhering to autoclave manufacturer's operating instructions.</li> <li>• Use Miltex® Stain Remover on both the instruments and autoclaves</li> <li>• Change to distilled or demineralized water, particularly if the local water supply is known to contain iron or other minerals.</li> <li>• Thoroughly wash and rinse wraps and towels with a neutral pH detergent.</li> </ul>

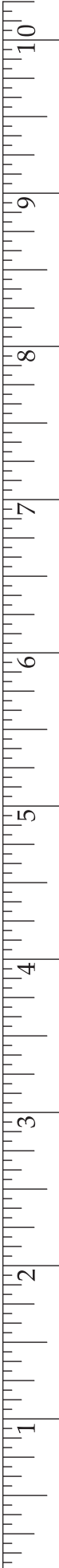

## INSTRUMENT WARRANTY

Miltex® and Padgett® Instruments are guaranteed to be free from material defects. Our Guarantee also includes a commitment to the very highest standards of quality craftsmanship which will be employed in the manufacture of each and every Instrument. If either of these high standards are not met by Miltex, our customer may return the Instrument to be repaired or replaced at our discretion and at no charge to the customer.

### PRODUCT WARRANTY

Miltex also offers to our customers an array of complementary surgical and dental products. These are held to the same high standards of material and workmanship as our instruments. However, all of these quality products are also provided with a limited one-year warranty.

- Chiropractic and Auto-Surgical Mallets
- Laparoscopic Instruments and Scopes
- Instrument Containers and Cassettes
- Chrome Instruments
- Electrosurgical Instrumentation
- Electrical Devices
- Podiatry Nipper/Splitter Springs
- Fiber Optic Instruments / Accessories

### REPAIR WARRANTY

If for any reason a customer is dissatisfied with a Miltex® repair, we guarantee to replace or again repair the product at no charge if the instrument is returned within 30 days. We request that our customers assist us in protecting our employees by returning cleaned and sterilized instruments for repair.

### WARRANTY STIPULATIONS

Our Warranty is effective from the date-of-purchase only from either Miltex or an Authorized Miltex Distributor. The warranty remains in effect if the Instrument or Product is used for its intended surgical or dental purpose as well as continuous and proper care of the Instrument or Product is maintained.

### OTHER WARRANTY INFORMATION FOR OUR CUSTOMERS

- We ask our customers to use only the Miltex® Repair Services for our products so the warranty remains in effect.
- We love to meet your unique or special needs with custom produced products. However, these are not returnable.
- Miltex offers excellent Care and Cleaning products for our instruments. Please use these products or other appropriate cleaning products to properly maintain your instrument as a valuable asset. Proper care and cleaning of your instruments is also a requirement to maintain the instrument warranty.
- We strongly recommend that you use the appropriate instrument for the identified clinical need. Misuse of instruments can cause damage to the instrument or product and will void the warranty.
- Hurricanes, fires or other disasters will void the warranty of your instruments.

### A FINAL & REQUISITE STATEMENT

As set forth in these Terms, Conditions, Policy and Warranty, Miltex makes no other representations, either expressed or implied, which supersede the above descriptions. In no event will Miltex be liable for any incidental, special or exemplary damages or loss of profits in connection with the use of a Miltex® Instrument or Product.





## TERMS & CONDITIONS

### ORDERS AND QUOTATIONS

Contact Miltex, Inc., 589 Davies Drive, York, PA 17402 or call toll free 1-866-854-8300 to place orders and for formal quotations. Orders may also be placed via toll-free fax 1-866-854-8400, on our web site at [www.miltex.com](http://www.miltex.com) (registered authorized distributors only) or through Electronic Data Interchange (EDI).

### TERMS

All invoices are payable net 30 days from date of invoice.

### FREIGHT

Prices quoted are FOB factory. Prices are subject to change without notice.

Orders will be shipped via the carrier of Miltex's choice unless the distributor requests a particular service. If a special request is made, an additional handling charge will be included on the invoice to cover the resulting processing and carrier charges.

### ACCEPTANCE

All orders are subject to approval by Miltex.

Miltex herewith reserves the right to alter the design or form of any product or to discontinue any product prior to the date of delivery without incurring any obligation to make such changes in any items previously purchased, whether or not delivered.

### CREDIT

Miltex reserves the right to refuse orders, suspend credit and cancel unfulfilled orders when credit conditions of a customer warrant such action.

### SHIPMENTS, DAMAGES, & SHORTAGES IN TRANSIT

Shipment schedules are approximate and are as accurate as conditions permit on the date the schedules are provided. Miltex assumes no responsibility or liability for unforeseen delays in making delivery. When signing for receipt of goods, all visible damage and/or shortages to cartons must be indicated on the carrier delivery receipt so that a claim may be filed with the carrier. The customer shall inspect all items upon arrival and give written notice to Miltex of any claim for a shortage or non-conformance within 7 days after receipt of shipment.

Miltex may make partial shipments, which the distributor shall accept and pay for at the prices specified on maturity of the invoice involved.

### RETURN MATERIALS POLICY

A Returned Materials Authorization number (RMA) must be obtained prior to returning product to Miltex. Product returned without an RMA number will be returned directly to the distributor, at our cost, with a letter of explanation. Returns can only be granted and authorized by obtaining an RMA number from Miltex customer service at toll free 1-866-854-8300.

Issue of an RMA number should not be interpreted as a final credit to your customer account. Miltex reserves the right to evaluate incoming returns prior to issuing any customer credit.

There will be a 15% restocking charge for product returned after 60 days but before 120 days after receipt of shipment. Product must be returned unused in its original packaging. No returns will be accepted after 120 days after receipt of shipment. Non-returnable products received by Miltex will be returned directly to the distributor, at our cost, with a letter of explanation. Sterile products which have been opened, returned out of the original package or returned after the sterile expiration date are not returnable.

Discontinued products, medicament products, private labeled, custom made, custom etched or neutralized products are not returnable.

Broken instruments noted as 'Sharps' have special handling and return requirements. Call customer service toll free 1-866-854-8300 for information regarding special shipping and handling requirements.

## INSTRUMENT SERVICE, REPAIR AND RETURN INSTRUCTIONS

Miltex, Inc. offers you the expertise and convenience of operating its own in-house Service and Repair Department. Please follow our simple return instructions to ensure all returns and repairs are processed correctly and in a timely manner. Your instruments are as important to us as they are to you.

**Please contact Miltex® Customer Service Department at 1.866.854.8300 or repairs@miltex.com to obtain a Return Material Authorization (RMA) number.**

Be prepared to provide the following information:

- Customer account number
- Customer purchase order number

**IMPORTANT:**

**Any instrument sent to Miltex, Inc. without an RMA number and/or not sterilized, will be returned to sender. For fast and easy processing, please email or fax the quantities and part numbers on office letterhead to Miltex Customer Service. Fax: 866-854-8400**

Once you have received your RMA number, instruments should be sent to:

Miltex, Inc. / Repair Department 589 Davies Drive York, PA 17402 USA

RMA#: \_\_\_\_\_ (NEEDED ON OUTSIDE OF SHIPPING BOX)

How to Package and Ship Instruments:

- *Miltex cannot accept instruments that have not been properly cleaned, sterilized and enclosed with sterilization indicator tape/wrap.*
- *Include the RMA number*
- *Properly package instruments to protect them during transit.*
- *Use a common carrier (FedEx, UPS).*
- *Insure the package, and keep a record of the tracking number.*
- *Include all contact information to ensure timely return of your instruments.*

NOTE: We cannot accept instruments for repair at conventions or trade shows. Miltex, Inc. representatives cannot accept instruments for repair. Please follow the instructions above.

If you have questions or comments, contact Customer Service at 1.866.854.8300 or repairs@miltex.com.





**10% OFF**

### REPAIR 5 INSTRUMENTS, RECEIVE A 10% DISCOUNT

**Send in 5 or more repairable instruments and receive 10% off the total price of the repair!**

For end-users only. Does not apply to government, institutional, or dealer repairs. To obtain your 10% discount, mail this voucher along with product (5 or more repairable instruments) for repair to Miltex, Inc. Attn: Return/Repair Department, 589 Davies Drive, York, PA 17402 (1-866-854-8300). Call for RMA. Discount void if not accompanied by this voucher and 5 or more repairable instruments.



**10% OFF**

# SUGGESTED INSTRUMENT SETS



Blepharoplasty Set

Abdominoplasty (Tummy Tuck) Set

General Breast Augmentation Instrument  
Set for Inframammary and Periareolar

Transaxillary Breast Augmentation Set

TUBA (Transumbilical) Breast Augmentation Set

Rhytidectomy, Platysmaplasty, SMASectomy,  
Forehead Lift and Facial Implant Set

Rhinoplasty Set

Cleft Palate Set

## Blepharoplasty Set

Qty	Catalog#	Description	Qty	Catalog#	Description
1	4-7*	Knife Handle No. 3	1	26-1084*	Frazier Dura Hook
2	7-26*	Hartman Mosquito Forceps, curved	1	21-154*	Joseph Double Hook
1	8-7TC*	Webster Needle Holder, TC, smooth jaws	1	PM-4347	Kawamoto Double-Ended Retractor, 5 mm & 10 mm blades, insulated
1	PM-2415	Halsey Needle Holder, TC, smooth jaws	1	18-1968*	Freer Elevator
2	PM-4793	Bishop-Harmon Iris Forceps, 1 x 2 teeth, 0.3mm	1	PM-5020	Jaeger Lid Plate
1	PM-3727	Castroviejo Suturing Forceps, 1 x 2 teeth, 0.9mm	1	19-575*	Frazier Suction Tube, 10 FR, angled
1	PM-4704	Iris Scissors, curved	1	PM-7103	Dandy Forceps, curved sideways
1	PM-6860	Stevens Tenotomy Scissors, SC, curved	2	PM-4311	Smith Corneal Protection Shield, 21mm
1	PM-6435	Blepharoplasty Scissors, TC, curved	1	PM-5012	Laser Eye Shield Set w/ Suction Handle
1	18-650*	Castroviejo Caliper	1	4-6815*	Cassette, large (not pictured)
			1	4-6815MAT*	Mat for large Cassette (not pictured)

\*Miltex® Brand



4-7



7-26



8-7TC



PM-2415



PM-4793



PM-3727



PM-4704



PM-6860



PM-6435



18-650



26-1084



21-154



PM-4347



18-1968



PM-5020



19-575



PM-7103



PM-4311



PM-5012

## Abdominoplasty (Tummy Tuck) Set

Qty	Catalog#	Description
1	4-7*	Knife Handle No. 3
4	FLM-125	Halsted Mosquito Forceps, curved
2	PM-2120	Mayo-Hegar Needle Holder, TC
1	8-6TC*	Webster Needle Holder, TC, smooth jaws
2	6-121*	Adson Tissue Forceps, 1 x 2 teeth & Cross Serrated
2	21-160*	Joseph Hook, sharp
1	PM-0462	Mayo Scissors, straight
1	PM-6835	Gorney Freeman Scissors, SC, curved
1	PM-6810	Metzenbaum Scissors, SC, curved
1	18-SC-1476*	Stevens Tenotomy Scissors, SC, curved

Qty	Catalog#	Description
3	12-80*	Lahey Forceps, 3 x 3 teeth
2	16-10*	Allis Tissue Forceps, 5 x 6 teeth
1	PM-6125	Brown-Adson Forceps, 9 x 9 teeth
1	11-122*	US Army Retractor, 2/set
1	6-46*	Tissue Forceps, 1 x 2 teeth
1	PM-4772	Iris Scissors, TC, straight
1	PM-0676	Flexible Ruler
1	PM-566	Yancoskie Retractor, 6 prongs
1	PM-509IL	Freeman Retractor, 4 prongs, 1-1/2"
1	PM-519IL	Freeman Retractor, 4 prongs, 7/8"
1	11-240*	Meyering Retractor, large
1	PM-397	Lockwood Abdominal Demarcator

\*Miltex® Brand



4-7



FLM-125



PM-2120



8-6TC



6-121



21-160



PM-0462



PM-6835



PM-6810



18-SC-1476



12-80



16-10



PM-6125



11-122



6-46



PM-4772



PM-0676



PM-566



PM-509IL



PM-519IL



11-240



PM-397

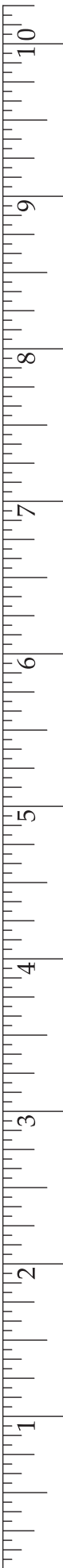

## General Breast Augmentation Instrument Set for Inframammary and Periareolar

Qty	Catalog#	Description
1	4-7*	Knife Handle No. 3
4	FLM-125	Halsted Mosquito Forceps, curved
1	PM-6811	Metzenbaum Scissors, SC, curved
1	PM-6835	Gorney Freeman Scissors, SC, curved
1	PM-0462	Mayo Scissors, straight
1	PM-2706	Iris Scissors, TC, straight
1	2-104SS*	Yankauer Suction Tube
1	19-577*	Frazier Suction Tube, 12 FR
1	PM-6128	Adson Dressing Forceps
1	PM-6129	Adson Tissue & Suture Forceps, 1 x 2 teeth w/tying platform
1	PM-6125	Brown-Adson Forceps, 9 x 9 teeth
1	6-48*	Tissue Forceps, 1 x 2 teeth
1	6-14*	Dressing Forceps, serrated
1	PM-464	Freeman Areola Marker, 38mm
1	PM-465	Freeman Areola Marker, 42mm
1	PM-467	Freeman Areola Marker, 45mm
1	PM-466	Freeman Areola Marker, 50mm
1	PM-4944	McKissock Breast Marker, 38mm, Keyhole pattern
1	PM-4945	McKissock Breast Marker, 42mm, Keyhole pattern
1	PM-4946	McKissock Breast Marker, 45mm, Keyhole pattern
1	PM-2120	Mayo-Hegar Needle Holder, TC
1	8-6TC*	Webster Needle Holder, TC, smooth jaws
1	PM-2415	Halsey Needle Holder, TC, smooth jaws
1	PM-8750	McKissock Mammoplasty Caliper
1	PM-0676	Flexible Ruler
1	PM-909	Spatula Breast Dissector
1	29-18-32*	Walther Sound 32FR
1	PM-9054	Silverstein Breast Dissector
2	21-160*	Joseph Hook, sharp
1	11-74*	Senn Retractor, sharp
1	11-122*	US Army Retractor, 2/set
1	PM-519IL	Freeman Retractor, 4 prong, 7/8"
1	11-146*	Pediatric Ribbon Retractor, malleable
1	PM-895FO	Ferreira Fiber Optic Retractor
1	PM-4570FO	Deaver Fiber Optic Retractor
1	PM-899FO	TBTS Fiber Optic Retractor, with teeth

\*Miltex® Brand







4-7



FLM-125



PM-6811



PM-6835



PM-0462



PM-2706



2-104SS



19-577



PM-6128



PM-6129



PM-6125



6-48



6-14

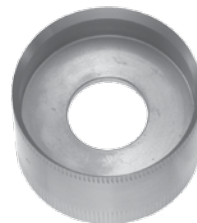

PM-464  
PM-465  
PM-467  
PM-466



PM-4944  
PM-4945  
PM-4946



PM-2120



8-6TC



PM-2415



PM-8750



PM-0676



PM-909



29-18-32



PM-9054



21-160



11-74



11-122



PM-5191L



11-146



PM-895FO



PM-4570FO



PM-899FO

## Transaxillary Breast Augmentation Set

Qty	Catalog#	Description
1	29-102*	Mathieu Grasping Forceps
1	35-604*	Laparoscope, 30 degree, 10mm OD
1	5-192*	Metzenbaum Scissors, curved, 11"
1	5-194*	Metzenbaum Scissors, straight, 14-1/2"
1	PM-4990	Agris-Dingman Breast Dissectors (Set of 2 - L & R)
2	4-7*	Knife Handle No. 3
4	FLM-125	Halsted Mosquito Forceps, curved
2	11-74*	Senn Retractor, sharp
1	11-122*	US Army Retractor, 2/set
2	21-160*	Joseph Hook, sharp

Qty	Catalog#	Description
1	PM-6811	Metzenbaum Scissors, SC, curved
1	PM-6128	Adson Dressing Forceps
2	PM-6129	Adson Tissue & Suture Forceps, 1 x 2 teeth w/ tying platform
1	PM-6125	Brown-Adson Forceps, 9 x 9 teeth
2	PM-2120	Mayo-Hegar Needle Holder, TC
2	8-6TC*	Webster Needle Holder, TC, smooth jaws
1	PM-0462	Mayo Scissors, straight
1	PM-2706	Iris Scissors, TC, straight
1	PM-4570FO	Deaver Fiber Optic Retractor
1	PM-895FO	Ferreira Fiber Optic Retractor

\*Miltex® Brand





## TUBA (Transumbilical) Breast Augmentation Set

Qty	Catalog#	Description	Qty	Catalog#	Description
1	35-601*	Laparoscope, 30 degree, 5mm OD	1	PM-6128	Adson Dressing Forceps
1	11-130*	Ribbon Retractor	2	PM-6129	Adson Tissue & Suture Forceps, 1 x 2 teeth w/tying platform
1	5-192*	Metzenbaum Scissors, curved, 11"	1	PM-6125	Brown-Adson Forceps, 9 x 9 teeth
1	5-194*	Metzenbaum Scissors, straight, 14-1/2"	2	PM-2120	Mayo-Hegar Needle Holder, TC
1	29-102*	Mathieu Grasping Forceps	2	8-6TC*	Webster Needle Holder, TC, smooth jaws
2	4-7*	Knife Handle No. 3	1	PM-6811	Metzenbaum Scissors, SC, curved
4	FLM-125	Halsted Mosquito Forceps, curved	1	PM-0462	Mayo Scissors, straight
2	11-74*	Senn Retractor, sharp	1	PM-2706	Iris Scissors, TC, straight
1	11-122*	US Army Retractor, 2/set	1	PM-21970	TUBA Complete Set - 5 Instruments
2	21-160*	Joseph Hook, sharp			

\*Miltex® Brand

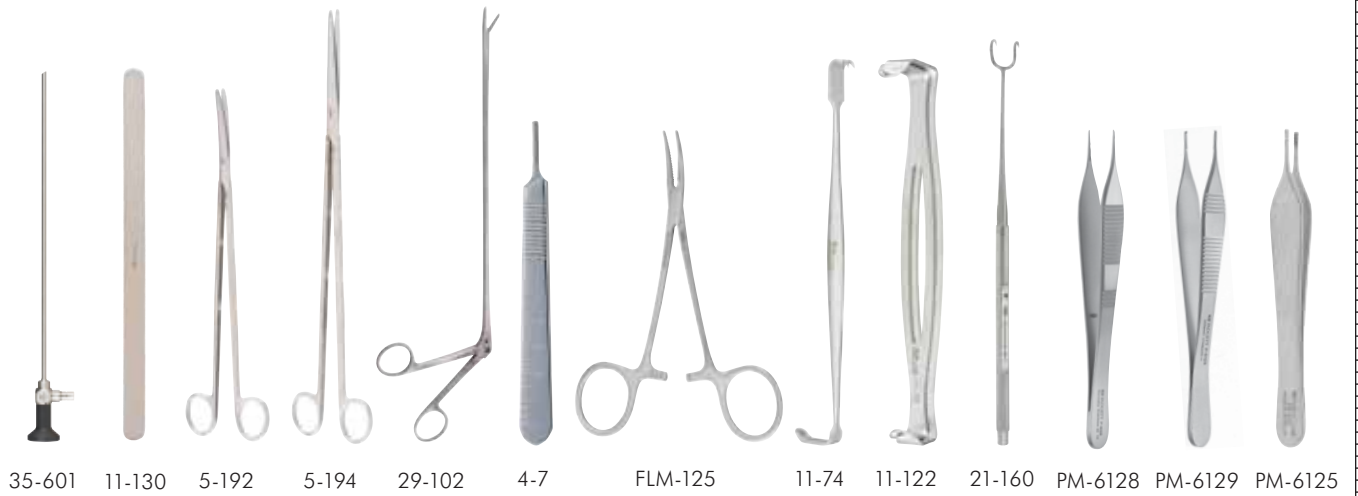

PM-21970 TUBA Set

## Rhytidectomy, Platysmaplasty, SMASectomy, Forehead Lift and Facial Implant Set Combination Face and Neck

Qty	Catalog#	Description
1	4-17*	Siegel Knife Handle
1	PM-0676	Flexible Ruler
4	7-4*	Halsted Mosquito Forceps, curved
1	7-242*	Adson Hemostatic Forceps, curved
2	16-6*	Allis Tissue Forceps, 4 x 5 teeth
1	19-575*	Frazier Suction Tube, 10 FR
1	2-104SS*	Yankauer Suction Tube
1	PM-6835	Gorney Freeman Scissors, SC, curved
1	5-181*	Metzenbaum, straight
1	PM-2706	Iris Scissors, TC, straight
1	PM-6105	Adson Dressing Forceps, serrated
2	6-121*	Adson Tissue & Suture Forceps, 1 x 2 teeth w/serrated tying platform
1	PM-6125	Brown-Adson Forceps, 9 x 9 teeth
1	PM-9436	Bayonet Bipolar Forceps, 1.0 mm tips
1	6-192*	Cushing Tissue Forceps, Bayonet, 1 x 2 teeth
1	PM-2120	Mayo-Hegar Needle Holder, TC
1	PM-2435	Crile-Wood Needle Holder, TC, smooth jaws
2	21-160*	Joseph Double Hook, sharp
1	21-89*	Gillies Skin Hook
1	11-122*	US Army Retractor, 2/set
1	22D-209*	University of Minnesota Cheek Retractor
1	PM-391	D'Assumpcao Face Lift Marker
1	PM-890FO	Ferreira Fiber Optic Retractor
1	PM-5551FO	Aufricht Fiber Optic Retractor
1	PM-4570FO	Deaver Fiber Optic Retractor, 5/8"
1	PM-4571FO	Deaver Fiber Optic Retractor, 1"
1	DELM9*	#9 Molt Elevator
1	PM-4971	Tessier Periosteal Elevator, 6 mm Wide
1	PM-4972	Tessier Periosteal Elevator, 7 mm Wide
1	PM-4973	Tessier Periosteal Elevator, 9 mm Wide
1	21-50*	Scalp Elevator Dissector, curved, 7 mm
1	21-51*	Frontotemporal Dissector, curved, 7 mm
1	21-52*	Frontotemporal Dissector, straight, 10 mm
1	21-53*	Corrugator and Procerus Muscle Dissector, S-shaped, 5 mm

\*Miltex® Brand





4-17



PM-0676



7-4



7-242



16-6



19-575



2-104SS



PM-6835



5-181



PM-2706



PM-6105



6-121



PM-6125



PM-9436



6-192



PM-2120



PM-2435



21-160



21-89



11-122



22D-209



PM-391



PM-890FO



PM-5551FO



PM-4570FO  
PM-4571FO



DELM9



PM-4971  
PM-4972  
PM-4973



21-50



21-51



21-52



21-53



## Rhinoplasty Set Gruber Set

Qty	Catalog#	Description
1	PM-805	Fowler Aluminum Mallet, 10 oz.
1	PM-878	Gruber Nasal Tip Sizers, set of 3
1	PM-877	Gruber Open Rhinoplasty Retractor
1	PM-876	Gruber Columella Retractor with Weight
1	18-1476*	Stevens Tenotomy Scissors, Curved, Blunt
2	21-156*	Joseph Double Hook, Sharp, 5 mm
2	21-160*	Joseph Double Hook, Sharp, 10 mm
1	PM-0536	Gillies Skin Hook
1	PM-3825	Gorney-Hammrick Suction Dissector, 3 mm
1	PM-444	Gruber Combination #7 Knife Handle & Perichondrium Elevator
1	21-370*	Fomon Rasp, Fine, Double-Ended
1	PM-4881	Fomon Rasp, Coarse Flat/Convex Reverse Cut
1	PM-666	Cottle Cartilage Crusher Smooth
1	PM-9323	Small Sterilization Box/Tray For Tip Sizers
1	18-657*	Thorpe Caliper
1	PM-5705	Maliniac Nasal Retractor
1	21-280*	Joseph Nasal Saw, Straight
1	21-282*	Joseph Nasal Saw, Right
1	21-284*	Joseph Nasal Saw, Left
1	20-29*	Killian Speculum, 2-1/2"
1	20-32*	Killian Speculum, 3-1/2"
1	PM-2160	Olsen-Hegar Needle Holder & Scissors, Serrated, TC
1	PM-2165	Olsen-Hegar Needle Holder & Scissors, Smooth, TC
1	PM-6105	Adson Dressing Forceps Delicate, Cross Serrated Tips
1	PM-6125	Brown-Adson Tissue Forceps, 9 x 9 Teeth
1	19-370*	Lucae Ear Forceps, bayonet shape, serrated tips
1	PM-3806	Lambotte Osteotome, 10 mm
1	11-73*	Ragnell Retractor, Double-ended
1	20-202*	Freer Submucous Knife, Angled Blade
1	21-232*	Neivert Osteotome, Straight
1	PM-7760	Joseph Periosteal Elevator, Slightly Curved
1	PM-7740	Cottle Graduated Elevator, Double-ended
1	PM-0630	Gruber Cartilage Cutting Block, Silicone

\*Miltex® Brand





PM-805

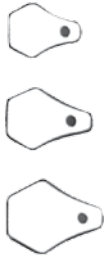

PM-878



PM-877



PM-876



18-1476



21-156  
21-160



PM-0536



PM-3825



PM-444



21-370



PM-4881



PM-666



PM-9323



18-657



PM-5705



21-280



21-282  
21-284



20-29  
20-32



PM-2160  
PM-2165



PM-6105



PM-6125



19-370



PM-3806



11-73



20-202



21-232



PM-7760



PM-7740



PM-0630



## Cleft Palate Set

Qty	Catalog#	Description
1	2-115*	Dingman Mouth Gag, Complete
1	18-650*	Castroviejo Caliper
1	5-264*	Dean Dissecting Scissors
1	18-SC-1476*	Stevens Tenotomy Scissors, SC, Curved
1	5-306TC*	Iris Scissors, TC, Curved
1	5-180TC*	Metzenbaum Scissors, TC, Curved
1	PM-7802	Blair Cleft Palate Elevator, Curved
1	PM-7800	Blair Cleft Palate Elevator, L-Shaped
1	PM-7801	Blair Cleft Palate Elevator, Right Angle
1	PM-600	Cronin Cleft Palate Elevator, Large
1	PM-601	Cronin Cleft Palate Elevator, Medium
1	PM-602	Cronin Cleft Palate Elevator, Small
1	PM-1298	Elevator, Double-ended Angled to Right & Left
1	PM-1302	Elevator, Double-ended Spoon Shaped
1	20-246*	Pennington Septum Elevator, sharp
1	PM-1292D	Cleft Palate Rasp, Curved Down
1	PM-1292U	Cleft Palate Rasp, Curved Up
1	PM-1284L	Cleft Palate Rasp, Curved Up Left
1	PM-1284R	Cleft Palate Rasp, Curved Up Right
1	PM-1306M	McIndoe Cleft Palate Rasp Double-ended, Medium
1	PM-1306S	McIndoe Cleft Palate Rasp Double-ended, Small
1	PM-604	Cronin Cleft Palate Knife Rectangular
1	PM-603	Cronin Cleft Palate Knife Triangular
1	PM-605	Cronin Septum Knife w/cm markings
1	PM-1312	Mitchell Trimmer, Double-Ended
1	22-662*	Schmidt Forceps
1	PM-9421	Jeweler's Bipolar Forceps 0.5 mm tips
1	6-48*	Thumb Tissue Forceps, 1 x 2 teeth
1	21-154*	Joseph Double Hook, sharp, 2 mm
1	21-156*	Joseph Double Hook, sharp, 5 mm
1	23-12-4*	Laryngeal Mirror, size 4
1	23-12-5*	Laryngeal Mirror, size 5
1	PM-2322	Micro Vascular Needle Holder, TC, serrated
2	8-6TC*	Webster Needle Holder, TC, smooth

\*Miltex® Brand





2-115



18-650



5-264



18-SC-1476



5-306TC



5-180TC



PM-7802



PM-7800



PM-7801



PM-600  
PM-601  
PM-602



PM-1298



PM-1302



20-246



PM-1292D  
PM-1292U



PM-1284L  
PM-1284R



PM-1306M  
PM-1306S



PM-604  
PM-603  
PM-605



PM-1312



22-662



PM-9421



6-48



21-154  
21-156



23-12-4  
23-12-5



PM-2322



8-6TC

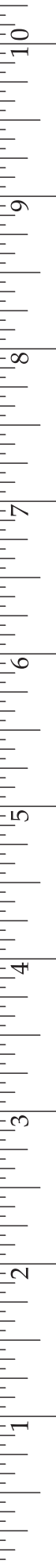

<b>A</b>	
Abdominal Demarcator .....	309
Abdominoplasty Retractor .....	133
Abdominoplasty Set .....	385
Ackerman Areola Marker .....	306
Adams Pliers .....	296
Adamson Hook and Retractor .....	118
Adenoid Curette .....	344
Adenoid Forceps .....	86, 344
Adhesive Strips .....	368
Adson Bipolar Forceps .....	76
Adson-Brown Tissue Forceps .....	46, 53
Adson Dissecting Forceps .....	45, 50, 51, 60
Adson Dressing Forceps .....	45, 51
Adson-Gorney Tissue Forceps .....	46
Adson Hemostat .....	105
Adson-Horton Tissue Forceps .....	45
Adson Tissue Forceps .....	45, 51, 52, 53
Agris-Dingman Dissector .....	28
Alae Retractor .....	128
Alar Cartilage Scissors .....	236
Alexander Knife .....	157
Alligator Ear Forceps .....	83, 85, 320-323
Alligator Scissors .....	264, 323
Allis Tissue Forceps .....	78
Alm Retractor .....	135
Aluminum Orthopedic Hand .....	274
Aluminum Skin Hooks .....	112, 113
Amar Clamp .....	82
Antrum Punch Forceps .....	93, 338
Arch Bar Material .....	286
Arch Bending Pliers .....	293
Areola Markers .....	304, 306
Army Navy Retractor .....	129
Asch Forceps .....	80
Atraumatic Tissue Forceps .....	63
Aufricht Glabellar Rasp .....	197
Aufricht-Peet Rasp .....	196
Aufricht Retractor .....	121, 314
Aufricht Scissors .....	236, 238
Autoclave Instrument Wrap .....	371
Awls .....	186
<b>B</b>	
Baby-Mixer Forceps .....	103
Back-Biting Forceps .....	93, 338, 340
Backhaus Towel Clamp .....	100
Ball End Elevator .....	36, 343
Ball End Retractor .....	120
Ballenger Chisel .....	6
Ballenger Elevator .....	35
Ballenger-Hajek Elevator .....	35
Ballenger Swivel Knife .....	155
Bandage Scissors .....	265, 266
Bard-Parker Knife Handle .....	150
Barraquer Blade Breaker .....	153
Barraquer-Troutman Mini Blade Breaker & Holder .....	153
Barrons Knife Handle .....	150
Barsky Dissecting Forceps .....	61
Barsky Glabellar Rasp .....	197
Barsky Ligature Forceps .....	65
Barsky Nasal Rasp .....	197
Barsky Nasal Retractor .....	136
Barsky Pharyngeal Elevator .....	31
Barsky Rasp .....	201
Barsky Scissors .....	238
Barsky Skin Hook .....	116
Basins, Emesis .....	360
Basins, Solution .....	359
Baumgartner Needle Holder .....	169, 179
Baylis-Zarem Eyelid Retractor .....	123
Bayonet Bipolar Forceps .....	76, 77
Bayonet Forceps .....	50, 65, 67, 68, 99
Bayonet Osteotomes .....	10
Becker Septum Scissors .....	254
Bellucci Alligator Scissors .....	264, 323
Bellucci Ear Forceps .....	85, 322
Bellucci-House Alligator Scissors .....	84, 321
Berke Ptosis Forceps .....	69
Berrino Knife Handle .....	150
Beyer Rongeur .....	13
Biggs Face Lift Retractor .....	140, 312
Biggs Mammoplasty Retractor .....	139, 313
Bihrl Needle Holder/Clamp .....	178
BiopBlade™, Disposable .....	349
Biopsy Forceps, Nasal .....	92, 335, 337
Biopsy Punches, Disposable .....	348
Bipolar Cords .....	77
Bipolar Forceps .....	76, 77, 391
Bird Beak Wire Forming Pliers .....	292
Bishop-Harmon Iris Dressing Forceps .....	66
Bishop-Harmon Iris Tissue Forceps .....	60
Blade Breakers .....	153
Blades .....	152, 159
Blade-Safe Blade Remover .....	352
Blair Cleft Palate Elevator .....	41
Blair Retractor .....	125
Blakesley Forceps .....	89, 97, 334
Blakesley-Weil Forceps .....	90, 337
Blakesley-Wilde Ethmoid Forceps .....	88, 333
Blepharoplasty Forceps .....	55
Blepharoplasty Scissors .....	231, 232, 254
Blepharoplasty Set .....	384
Blocksma Palate Hook .....	117
Blumenthal Rongeur .....	13
Boies Elevator .....	34, 343
Boley Gauge .....	301
Bone Chisels .....	6
Bone Cutting Wire Forceps .....	16-17
Bone Drill .....	276
Bone Files .....	203
Bone Grinder .....	164
Bone Holding Forceps .....	79
Bone Rongeurs .....	13-17
Bow Retractor .....	144
Bowls .....	359
Bowman Probe .....	187
Boyd Scissors .....	258
Braithwaite Chisel .....	2
Braithwaite Dissecting Forceps .....	63
Brand Tendon Forceps .....	81, 82
Brand Tendon Stripper .....	277
Brauer Chisel .....	2
Breast Augmentation Sets .....	386-389
Breast Dissectors .....	21-25, 27-28
Breast Markers .....	304-306
Breast Measuring .....	304-306
Breast Retractors .....	139, 313
Brophy Scissors .....	260
Brown-Adson Tissue Forceps .....	46, 53
Brown Dissecting Scissors .....	261, 262
Brown-Griffiths Tissue Forceps .....	54
Brown Nasal Splint .....	269
Brown Needle Holder .....	181
Brown Tissue Forceps .....	54
Brueckmann Orthopedic Hand .....	275



Brushes.....	201, 354, 366	Color Bands.....	368
Bunnell Bone Drill .....	276	Columella Forceps .....	69
Bunnell Bone Holding Forceps .....	79	Columella Retractor .....	137
Bunnell Tendon Passer and Probe.....	191	Comedone Extractors.....	278-279
Bunnell Tendon Stripper.....	277	Converse Curette .....	19
Bunt Holder .....	374	Converse Fixation Forceps .....	70
<b>C</b>		Converse Hand Retractor.....	138
Calipers.....	299-300	Converse Needle Holder .....	180
Canvas Instrument Wrap.....	371	Converse Rasp .....	200
Caplan Septum Scissors.....	254	Converse Retractor.....	126
Capsulotomy Knives .....	156-157	Converse Scissors.....	233, 235, 257
Carbon Steel Blades.....	352	Converse Skin Hook.....	111, 112
Care & Cleaning Instructions .....	377-378	Cooley Needle Holder.....	174
Care & Cleaning Products .....	364-367	Corneal Eye Shield .....	124
Caroline Finger Retractor.....	126	Coronal Brow Lift Retractor.....	132
Carroll Retractor & Hook .....	111	Corwin Wire Twister.....	169, 289
Carroll Tendon Forceps .....	81	Costa Wire/Suture Scissors .....	265, 290
Carroll Wire Twister.....	169, 289	Costen-Kerrison Rongeur.....	34, 343
Cartilage Block .....	268	Cottle Bulldog Nasal Scissors.....	260
Cartilage Chisels.....	2	Cottle Cartilage Crusher .....	164
Cartilage Crusher .....	164	Cottle Chisel.....	4
Cartilage Morselizer.....	165-166	Cottle Columella Forceps .....	69
Cartilage Scissors.....	236, 238, 252, 257	Cottle Dorsal Scissors.....	214, 222, 224, 253
Cassettes, Storage.....	370	Cottle Finishing Rasp .....	195
Cast & Plaster Shears .....	266	Cottle Graduated Elevator.....	40
Castanares Scissors.....	219, 251	Cottle Hook/Retractor .....	118
Castroviejo Blade Breaker & Holder .....	153	Cottle-Kazanjan Nasal Hump Forceps .....	16
Castroviejo Caliper .....	300	Cottle Knife.....	156
Castroviejo Needle Holder .....	175, 183	Cottle Nasal Rasp .....	196
Castroviejo Suture Forceps .....	70	Cottle Nasal Retractor .....	118
Cath Trays & Covers .....	361	Cottle-Peet Rasp .....	196
Ceramic Scissors.....	211-213	Cottle-Pickrell Elevator .....	42
Chalazion Forceps.....	69	Cottle Retractor/Hook .....	118
Chamberlain-Fries Hook .....	116	Cottle Septum Speculum.....	147, 148
Chamberlain-Fries Retractor .....	126	Cottle Skin Elevator .....	40
Chang Areola Marker.....	304	Cottle Thumb Hook.....	115
Cheek Retractor .....	144-146	Cottle-Walsham Septum Straightening Forceps .....	99
Chisels.....	2-6, 324	Crile Hemostat.....	103
Chisels, Bone .....	6	Crile Retractor.....	145
Chisels, Cartilage.....	2	Crile-Wood Needle Holder.....	171, 179
Chisels, Ear.....	42, 324	Cronin Cleft Palate Elevator .....	40
Chisels, Nasal.....	2	Cronin Cleft Palate Knife .....	157
Chisels, Septum.....	3, 4	Cronin Ink Well .....	303
Cinelli Osteotome.....	9	Cronin Lip and Nostril Retractor .....	146
Circular Cutting Punch.....	95, 340	Cronin Retractors .....	146
Clamps.....	100-101	Cronin Septum Knife .....	154
Cleaning Brushes .....	20, 354, 366	Cross Action Retractor .....	135
Cleft Palate Elevators.....	40, 41	Crow Coagulating Forceps .....	48
Cleft Palate Knives.....	157	CSR Wrap.....	376
Cleft Palate Rasps.....	200, 201	Cups, Iodine/Medicine .....	359
Cleft Palate Retractors .....	141-146	Curette, Dermal .....	19, 349
Cleft Palate Scissors .....	235, 253	Curette, Double Ended .....	18, 19, 325
Clip Applying Forceps.....	78	Curette, Ear .....	18, 325, 354
Clodius Bone Chisel .....	6	Curettes.....	18-19, 325, 349, 354
Clodius Dissecting Scissors .....	235	Curtin Retractor.....	122
Clodius Elevator.....	30	Cushing Bayonet Dressing Forceps.....	50
Clodius Fish Hook.....	114	Cushing Bayonet Tissue Forceps.....	65
Clodius Orbital Retractor.....	124	Cushing Bipolar Forceps.....	77
Clodius Retractor .....	114	Cushing-Brown Tissue Forceps.....	50, 58, 65
Cloth Instrument Wrap.....	371	Cushing Dressing Forceps.....	47, 58
Coagulating Forceps .....	48	Cushing Retractor.....	125
Coated Aluminum Orthopedic Hand.....	274	Cushing Tissue Forceps .....	57, 65
Cobaugh Eye Dressing Forceps.....	66	Cutting Block .....	268
Cobaugh Iris Tissue Forceps .....	59		
Cobbett Graft Knife.....	159	<b>D</b>	
Cohneys Scissors Introducer.....	238	D'Assumpcao Abdominal Flap Marker.....	309
Colburn-Miller File .....	202	D'Assumpcao Face Lift Marker.....	307
		D'Assumpcao Rhytidoplasty Marker.....	307

Dahlgren Iris Scissors..... 241  
 Dandy Forceps ..... 104  
 Darling Eccentric Bandage Scissors ..... 265  
 Davis Retractor..... 125  
 Davis Scissors ..... 227, 259  
 Dean Scissors ..... 243  
 Deaver Retractor ..... 130  
 Deaver Retractor, Fiber Optic..... 315, 316  
 Debakey Atraumatic Forceps..... 63  
 Delicate Skin Hook..... 109  
 DeMayo Discrimination Device ..... 273, 302  
 Denhardt Mouth Gag ..... 143  
 Derf Needle Holder..... 171, 180  
 Dermal Curettes, Disposable ..... 349  
 Dermal Curettes, Stainless Steel ..... 19  
 Dermal Punches, Disposable..... 348  
 Dermal Punches, Stainless Steel ..... 280  
 Dermatology Instrumentation ..... 278-280  
 Desmarres Chalazion Forceps..... 69  
 Desmarres Lid Retractor..... 122  
 Dieters-House Malleus Ear Nipper ..... 84, 321  
 Dingman-Agris Dissector ..... 28  
 Dingman Bone Holding Clamp ..... 79  
 Dingman-MacCollum Breast Dissector ..... 22  
 Dingman-Millard Mouth Gag ..... 142  
 Dingman Mouth Gag ..... 141, 345  
 Dingman Otoabrader..... 331  
 Dingman Periosteal Elevator ..... 30  
 Dingman-Pollock Displacer..... 35  
 Dingman-Pollock Utility Forceps ..... 64  
 Dingman Wire Passer ..... 191  
 Dingman Zygoma Hook..... 117  
 Dingman Zygomatic Elevator ..... 32  
 Discrimination Device ..... 273, 302  
 Displacer Septum Elevator ..... 35, 343  
 Disposable BiopBlade™ ..... 349  
 Disposable Biopsy Punches ..... 348  
 Disposable Dermal Curettes ..... 349  
 Disposable Ear Curettes ..... 354  
 Disposable ENT Packing Line ..... 355-357  
 Disposable Scalpels..... 350-351  
 Disposable Surgical Blades ..... 352  
 Dissecting Forceps ..... 60, 61, 62, 63, 70  
 Dissecting Scissors ..... 211, 217-219, 235, 237-238, 240,  
 ..... 243-245, 251, 253, 256, 258-259, 261-262  
 Dissectors ..... 21-29  
 Dissectors, Breast..... 21-25, 27-28  
 Dissectors, Facial ..... 28-29  
 Dissectors, Periosteal..... 29  
 Dissectors, Submucosal ..... 21  
 Dissectors, Suction ..... 21  
 Dorsal Scissors..... 214, 222, 224, 253  
 Double Action Rongeurs ..... 13-17  
 Double Ended Curettes..... 18, 19, 325  
 Double Ended Elevators..... 30-32, 34-37  
 Double Ended Rasps..... 193, 195, 198, 199, 200  
 Doughty-Kilner Mouth Gag ..... 142  
 Dowden-Kirn Bipolar Forceps ..... 77  
 Dressing Forceps..... 45, 46, 47, 48, 50, 51,  
 ..... 52, 56, 57, 58, 66, 67, 68  
 Dressing Jars with Covers ..... 360  
 Drill, Bone ..... 276  
 Duffy Ear Piercer ..... 308  
 Dunning Elevator and Curette ..... 38

**E**

Ear Crimper Forceps..... 84, 324  
 Ear Curette ..... 18, 325, 354

Ear Curettes, Disposable..... 354  
 Ear Forceps..... 83, 84, 85, 320, 321, 322  
 Ear Lobe Forceps..... 69  
 Ear Nipper Forceps..... 84, 324  
 Ear Packing, Disposable ..... 270, 355  
 Ear Scissors..... 323  
 East Grinstead Scissors..... 239  
 Edna Towel Clamp ..... 100  
 Elevators..... 30-42, 324, 343  
 Elevators, Cleft Palate..... 40-41  
 Elevators, Double Ended..... 30-32, 34-37, 343  
 Elevators, Ear ..... 34, 42, 324  
 Elevators, Nasal ..... 34, 343  
 Elevators, Periosteal..... 30, 32-34, 38-39  
 Elevators, Septal..... 35-38  
 Elevators, Zygomatic..... 32  
 Ellenbogen Bayonet Forceps ..... 65  
 Emesis Basins ..... 360  
 Endo Brow Dissectors ..... 29  
 Endoscopic Retractor..... 312  
 ENT Packing Line, Disposable ..... 270, 355-357  
 Enzyme Cleaner, All Purpose EZ-Zyme ..... 364  
 Epistaxis, Disposable ..... 270, 355  
 Epstein Carpal Tunnel Knife Guide ..... 157  
 Erich Arch Bar Material..... 286  
 Esmarch Bandage, Cast & Plaster Shears..... 266  
 Ethmoid Forceps ..... 88, 333  
 Ethmoid Forceps, Pediatric..... 88, 333  
 Evan Dissecting Forceps ..... 62  
 Evans Dressing Forceps ..... 48  
 Ewald Dressing Forceps ..... 46, 52  
 Ewald Tissue Forceps..... 46, 52  
 Extractors, Comedone ..... 278-279  
 Eye Retractors ..... 122-124  
 Eye Shields..... 124  
 EZ-Zyme All Purpose Enzyme Cleaner..... 364  
 EZ-Zyme, Foam ..... 364

**F**

Face Lift and Neck Combination Set..... 390  
 Face Lift Retractors ..... 132-134, 140, 312, 314  
 Face Lift Scissors ..... 212-216, 219-221, 228-229, 232,  
 ..... 234, 237, 251, 252, 259-262  
 Face Measuring Instruments ..... 307-308  
 Facial Dissectors ..... 28-29  
 Facial Implant Set..... 390  
 Facial Tri-Square ..... 308  
 Farabeuf Retractor..... 129  
 Farr Style Spring Retractor..... 135  
 Fascia Cutter ..... 276  
 Fascia Stripper ..... 276  
 Faust Retractor..... 138  
 Feilchenfeld Splinter Forceps..... 71  
 Feld Blepharoplasty Forceps ..... 55  
 Fenestrated Handle Forceps..... 51, 53, 60, 66, 384  
 Ferguson Suction Tube ..... 282  
 Ferreira Breast Augmentation Retractor ..... 139, 313  
 Ferreira Face Lift Retractor ..... 140, 314  
 Ferris-Smith Forceps ..... 97  
 Ferris-Smith-McCoy Periosteal Elevator..... 38  
 Ferris-Smith Rongeur ..... 15  
 Fiber Optic Accessories ..... 317-318  
 Fiber Optic Cable ..... 318  
 Fiber Optic Light Source ..... 317  
 Fiber Optic Retractors..... 311-316  
 Field Knife Handle..... 151  
 Files ..... 202-203  
 Fine Pointed Scissors ..... 236

Finishing Rasps.....	195
Fischl Retractor.....	145
Fish Hook Retractor .....	114
Fixation Forceps .....	70
Flap Grasping Forceps .....	79, 81
Flap Retractors.....	129, 134, 315
Flexible Shaft Retractor.....	120
Floor Grade Instruments, Sterile.....	353
Foerster Capsulotomy Knife .....	157
Foerster Forceps.....	107
Foerster Iris Dressing Forceps.....	66
Foerster Iris Tissue Forceps .....	60
Foerster Sponge Forceps .....	107
Fomon Chisel.....	3
Fomon Elevator .....	33
Fomon Rasp.....	195, 198, 199
Fomon Retractor .....	120
Fomon Scissors .....	214, 222, 224, 253, 263
Forceps Jars.....	360
Forceps, Alligator Ear .....	83, 85, 320, 322
Forceps, Bayonet.....	50, 65, 67, 68, 99
Forceps, Bipolar .....	76, 77, 391
Forceps, Blepharoplasty.....	55
Forceps, Bone Holding .....	79
Forceps, Chalazion.....	69
Forceps, Clip Applying.....	78
Forceps, Coagulating .....	48
Forceps, Columella .....	69
Forceps, Dissecting .....	60, 61, 62, 63, 70
Forceps, Dressing.....	45-48, 50-52, 56-58, 66-68
Forceps, Ear.....	83, 84, 85, 320, 321, 322
Forceps, Ear Crimper.....	84, 324
Forceps, Ear Nipper.....	84, 324
Forceps, Ethmoid .....	88, 333
Forceps, Fenestrated Handles .....	51, 53, 60, 66, 384
Forceps, Fixation .....	70
Forceps, Flap Grasping .....	79, 81
Forceps, Hemostatic.....	101-106
Forceps, Iris .....	59, 60, 66
Forceps, Jeweler.....	49, 72, 73, 74
Forceps, Micro .....	72, 73, 74
Forceps, Mosquito.....	101, 102
Forceps, Nasal.....	87-98, 332-341
Forceps, Ptosis.....	69
Forceps, Punch.....	93-96, 338-341, 344
Forceps, Septum.....	80
Forceps, Splinter.....	71
Forceps, Sponge Holding.....	107
Forceps, Suture .....	45, 46, 70, 71, 72
Forceps, Tendon.....	81, 82
Forceps, Tissue.....	45, 46, 51-60, 63-65, 78
Forceps, Tongue Seizing .....	106
Forceps, Towel .....	100
Forceps, Tungsten Carbide .....	44-50
Forceps, Utility .....	64
Forceps, Wire Closure .....	84, 321
Forehead Dissectors.....	29
Forehead Lift Set .....	390
Foster Scissors and Needle Holder.....	239
Fowler Aluminum Mallet .....	162
Fox Dermal Curette.....	19
Fracture Elevator .....	34, 343
Framer Hand Splint .....	275
Framer Tendon Passing Needle.....	185
Frazier Hook.....	109
Frazier Suction Tube .....	282
Frederick Scissors.....	254
Fredrick Face Lift Forceps .....	100
Freeman Areola Marker.....	304
Freeman Face Lift Retractor .....	133-134
Freeman Flap Retractor .....	129, 315
Freeman-Gorney Scissors .....	213, 216, 220, 229
Freeman-Kaye Scissors .....	212, 215, 221, 228
Freeman Rake Retractor.....	133-134
Freeman Scissors.....	216, 220, 252
Freeman Skin Hook.....	113
Freer Chisels.....	3, 5
Freer Gouge.....	11
Freer-Ingal Submucous Knife .....	154
Freer Mucosa Septum Knife .....	154
Freer-Obwegesser Elevator .....	39
Freer Septum Elevator.....	36
Freer Septum Knife .....	154
Freer Spatula .....	21
French Pattern Lacrimal Probes .....	187
French Pattern Osteotome .....	8
Friedland Scissors.....	233
Friedman Rongeur.....	14
Fries-Chamberlain Hook .....	116
Fries-Chamberlain Retractor .....	126
Fry-Kelsey Bone Awl .....	186
Furlong Tendon Stripper .....	277
Furnas Bayonet Osteotome.....	10
<b>G</b>	
Gauges .....	301
General Style Forceps.....	47
Gerzog Mallet.....	161
Gigli Saw.....	205
Gigli Saw Handle .....	205
Gillies Dissecting Forceps .....	61
Gillies Needle Holder.....	173
Gillies Skin Hook.....	111, 114
Gillies-Sheehan Needle Holder.....	182
Ginsberg Caliper .....	300
Giunta Nasal Scissors.....	233
Giunta Osteotome .....	10
Glabellar Rasps.....	193, 196, 197
Goldman Elevator .....	35, 343
Goldman-Fox Scissors.....	223, 234
Goodhill Ear Forceps.....	85, 322
Gorney-Adson Tissue Forceps .....	46
Gorney-Freeman Scissors .....	213, 216, 220, 229
Gorney-Hammrick Suction Dissector .....	221
Gorney Scissors .....	213, 216, 219, 220, 229, 252, 255
Gorney Septal Morselizer.....	166
Gouges .....	11-12
Gradle Scissors .....	219
Graduated Chisels .....	5
Grant Splinter Forceps.....	71
Graul Iris Scissors.....	243
Graul Tissue Forceps .....	59
Grazer Forceps .....	55
Green Fixation Forceps.....	70
Greenberg Par Scissors.....	232
Greg Comedone Extractor.....	278
Greven Ear Forceps.....	83, 320
Griffiths-Brown Tissue Forceps .....	54
Grooved Directors.....	189
Grossman Areola Marker .....	304
Gruber Cartilage Cutting Block .....	268
Gruber Columella Retractor .....	137
Gruber Knife Handle .....	150
Gruber Nasal Tip Sizers.....	268
Gruber Perichondrium Elevator .....	150
Gruber Rhinoplasty Procedure Set.....	137

Gruber Rhinoplasty Retractor ..... 137  
 Gruenwald Dressing Forceps ..... 68  
 Gruenwald Nasal Forceps ..... 98  
 Gum Scissors ..... 235  
 Gunter Morselizer ..... 166  
 Guthrie Hook ..... 110, 113

**H**

Habal Capsulotomy Knife ..... 156  
 Hajek-Ballenger Elevator ..... 35  
 Hajek Chisel ..... 4  
 Hajek-Kofler Sphenoid Punch Forceps ..... 94, 339  
 Hallack Comedone Extractor ..... 278  
 Halle Septum Elevator ..... 36  
 Halle-Tieck Nasal Speculum ..... 147  
 Halpern Breast Marker ..... 305  
 Halsey Needle Holder ..... 172, 181  
 Halstead Mosquito Forceps ..... 101  
 Hammers ..... 161-163  
 Hamrick-Gorney Suction dissector ..... 21  
 Hamra-Nigro Septum Forceps ..... 98  
 Hand Fixation Device ..... 274  
 Hand Instruments ..... 273-277  
 Hand Retractors ..... 138  
 Hand Table ..... 273  
 Hardee Rongeur ..... 14  
 Hardy Bipolar Forceps ..... 77  
 Harmon-Bishop Iris Dressing Forceps ..... 66  
 Harmon-Bishop Iris Tissue Forceps ..... 60  
 Hartman Mosquito Forceps ..... 102  
 Haynes Suture Scissors ..... 248  
 Hayton-Williams Maxillary Fracture Forceps ..... 82  
 Heany Needle Holder ..... 177  
 Heath Suture/Stitch Scissors ..... 239  
 Heden Gouge ..... 12  
 Hemostatic Forceps ..... 101-106  
 Hemostats ..... 102-107  
 Heymann Scissors ..... 256  
 Hildyard Biopsy Forceps ..... 90, 335  
 Hi-Level Bandage Scissors ..... 265  
 Hinderer Scissors ..... 234  
 Hollow Chop Pliers ..... 294-395  
 Holzheimer Cross-Action Retractor ..... 135  
 Hood Iris Scissors ..... 230  
 Hood Micro Dissecting Scissors ..... 251  
 Hood Micro Stitch Scissors ..... 251  
 Hooks ..... 109-118, 327  
 Horsely-Stille Bone Cutting Forceps ..... 17  
 Horton-Adson Tissue Forceps ..... 45  
 House Adapter ..... 283, 329  
 House Alligator Forceps ..... 83, 320  
 House-Bellucci Alligator Scissors ..... 264, 323  
 House Curettes ..... 18, 325  
 House-Dieters Malleus Ear Nipper ..... 84, 321  
 House Elevator and Chisel ..... 42, 324  
 House Hooks ..... 327  
 House Knives ..... 158, 328  
 House Needles ..... 186, 327  
 House Picks ..... 326  
 House-Sheehy Knife Curette ..... 18, 325  
 Howard Splinter Forceps ..... 71  
 Howarth Septum Elevator ..... 37  
 Hudson Dressing Forceps ..... 46, 52  
 Hudson Tissue Forceps ..... 46, 52  
 Humby Double Skin Hook ..... 116

**I**

Icnoclasts ..... 28

Incodostapedial Joint Knife ..... 158, 328  
 Indicator Strips ..... 376  
 Indicator Tapes ..... 376  
 Ingal-Freer Submucous Knife ..... 154  
 Ink Well ..... 303  
 Instrument Care & Cleaning Products ..... 364-367  
 Instrument Care Kit System ..... 366  
 Instrument Care Training DVD ..... 367  
 Instrument Cleaner ..... 364  
 Instrument Cleaner & Lubricant ..... 365  
 Instrument EZ-Zyme All Purpose Cleaner ..... 364  
 Instrument Lubricant ..... 365  
 Instrument Maintenance ..... 364-382  
 Instrument Prep Enzyme Foam ..... 364  
 Instrument Protectors ..... 369  
 Instrument Service, Repair and Return Instructions ..... 382  
 Instrument Spray Lube ..... 365  
 Instrument Stain Guide ..... 379  
 Instrument Stain Remover ..... 366  
 Instrument Storage System ..... 370  
 Instrument Stringers ..... 362, 374-375  
 Instrument Terms & Conditions ..... 381  
 Instrument Trays & Covers ..... 361, 371  
 Instrument Trays & Mayo ..... 360  
 Instrument Warranty ..... 380  
 Instrument Wrapper ..... 371  
 Insulated Retractors ..... 122-123  
 Intracardiac Needle Holder ..... 176  
 Intraoral Wiring Retractor ..... 143  
 Iodine & Medicine Cups ..... 359  
 Iris Forceps ..... 59, 60, 66  
 Iris Scissors ..... 211, 217, 218, 230, 231, 241-243

**J**

J Strippers ..... 29  
 Jabaley Scissors ..... 223  
 Jackson Scissors ..... 263  
 Jacobs Dissector ..... 27  
 Jacobson Bayonet Forceps ..... 68  
 Jaeger Lid Plate ..... 123  
 Jameson Caliper ..... 299  
 Jamison Scissors ..... 215, 221  
 Jansen Bayonet Dressing Forceps ..... 67  
 Jansen-Middleton Septum Forceps ..... 98, 342  
 Jar, Dressing ..... 360  
 Jar, Forceps ..... 360  
 Jarabak Wire Forming Pliers ..... 292  
 Jennings Mouth Gag ..... 143  
 Jeweler's Bipolar Forceps ..... 76  
 Jeweler's Forceps ..... 49, 72, 73, 74  
 Johns Hopkins Bulldog Clamp ..... 101  
 Jones Towel Clamp ..... 101  
 Joseph Bayonet Nasal Saw ..... 204  
 Joseph Elevator ..... 33  
 Joseph Hook ..... 110  
 Joseph Knife ..... 155, 156  
 Joseph-Maltz Nasal Saw ..... 204  
 Joseph Nasal Rasp ..... 197  
 Joseph-Peck Scissors ..... 231  
 Joseph Saw ..... 204  
 Joseph Scissors ..... 217, 221, 231, 256  
 Jost Cartilage Crusher ..... 164  
 Julian Needle Holder ..... 176  
 Juri Face Lift Retractor ..... 140

**K**

Kahn Scissors ..... 259  
 Kasdan Hand Retractor ..... 138

Kawamoto Retractor .....	123	Laser Eye Shield .....	124
Kaye-Freeman Scissors .....	212, 215, 221, 228	Latex-Free Silicone Mats .....	370
Kaye Scissors .....	212, 215, 220, 228, 232, 254, 260	Lead Hand .....	275
Kazanjian-Cottle Nasal Hump Forceps .....	16	Left Handed Needle Holders .....	170, 171, 172
Kelly Hemostat .....	103	Lempert Elevator .....	34, 324
Kelsey-Fry Bone Awl .....	186	Lewis Nasal Rasp .....	200
Kerrison-Costen Rongeur .....	96, 341	Lewis Skin Hook .....	111
Key Bone Cutting Forceps .....	17	Lid Retractors .....	122, 123
Keyes Dermal Punch Set .....	280	Light Wire Bird Beak Pliers .....	293, 295
Killian Antrum Cannula .....	282	Lingual Arch Forming Pliers .....	294
Killian Elevator .....	37	Lip Retractors .....	144-145
Killian Gouge .....	12	Lister Bandage Scissors .....	266
Killian-Sheen Septum Forceps .....	99	Lister Dissecting Forceps .....	63
Killian Speculum .....	148	Liston Bone Cutting Forceps .....	16
Killian Speculum, Fiber Optic .....	316	Liston-Ruskin Bone Cutting Forceps .....	17
Kilner Alae Retractor .....	128	Little Trocar Needle .....	185
Kilner Dissecting Scissors .....	262	Little Scissors .....	250
Kilner-Doughty Mouth Gag .....	142	Lockwood Abdominal Demarcator .....	309
Kilner-Martinez Nasal Retractor .....	127	Logan Bow .....	144
Kilner Nasal Retractor .....	128	Lorna Towel Clamp .....	100
Kilner Scissors .....	223, 240	Love Nerve Retractor .....	121
Kilner Skin Hook .....	109	Lucae Bayonet Dressing Forceps .....	67
Kilner Zygomatic Elevator .....	32	Lucae Mallet .....	162
Kilpatrick Retractor .....	144	Luer Lock Cap .....	92, 337
King Adenoid Punch Forceps .....	86, 344	Luer Lock Port & Channel .....	91, 336
Kirk Mallet .....	161		
Kirn-Dowden Bipolar Forceps .....	77	<b>M</b>	
Kleinert-Kutz Elevator and Dissector .....	31	MacCollum-Dingman Breast Dissector .....	22
Kleinert-Kutz Rongeur .....	14	Magill Suction Tube .....	282
Kleinert-Kutz Skin Hook .....	112	Magnetic Mat .....	374
Kleinert-Ragnell Retractor .....	119	Maliniac Nasal Retractor .....	128
Knapp Iris Scissors .....	242	Malleable Hooks .....	327
Knapp Retractor .....	126	Malleable Picks .....	326
Knapp-Rollet Retractor .....	125	Malleable Suture Passer .....	191
Knife, Capsulotomy .....	156-157	Mallets .....	161-163
Knife, Cleft Palate .....	157	Malleus Ear Nipper .....	84, 321
Knife Curette .....	18, 325	Maltz-Joseph Nasal Saw .....	204
Knife, Ear .....	325, 328	Maltz Rasp .....	194, 198
Knife Handles .....	150-151	Mammoplasty Hook .....	113
Knife, Incudostapedial Joint .....	158, 328	Mammoplasty Retractor .....	139, 313
Knife, Myringotomy .....	328	Mammoplasty Retractor, Fiber Optic .....	313
Knife, Nasal .....	155	Mancusi-Ungaro Scissors .....	237
Knife, Septum .....	154	Mandibular Strippers .....	29
Knife, Sickle .....	328	Marcotte Looping Pliers .....	295
Knife, Tympanoplasty .....	328	Marking Pen .....	303
Knight Scissors .....	230	Marshall Intraoral Wiring Retractor and Holder .....	143
Knives .....	154-157, 325, 328	Martinez-Kilner Nasal Retractor .....	127
Knowles Bandage Scissors .....	266	Mastectomy Hook .....	113
Kocher Clamp Forceps .....	106	Mathieu Needle Holder .....	176
Kocher Forceps .....	104	Mathieu Retractor .....	122
Koffler-Hajek Sphenoid Punch Forceps .....	94, 339	Mathieu Wire Forming Pliers .....	297
Kruggel Flap Grasping Forceps .....	81	Mats, for Storage Cassettes .....	370
Kurtay-D'Assumpcao Face Lift Marker .....	307	Maxillofacial Osteotomes .....	10
Kurth Suture Forceps .....	71	Mayo-Hegar Needle Holder .....	170, 179
Kutz-Kleinert Elevator and Dissector .....	31	Mayo-Noble Scissors .....	244
Kutz-Kleinert Rongeur .....	14	Mayo Scissors .....	211, 218, 226, 244, 245
Kutz-Kleinert Skin Hook .....	112	Mayo Trays .....	360
		McCoy Facial Tri-Square .....	308
<b>L</b>		McCoy-Ferris-Smith Periosteal Elevator .....	38
Lab & Office Pliers .....	291	McCoy Micro-Dermal Hook .....	116
Lahey Forceps .....	78	McGee Ear Crimper/Wire Closure Forceps .....	84, 321
Lahey Retractor .....	119	McIndoe Bone Cutting Forceps .....	17
Lambotte Osteotome .....	8	McIndoe Dissecting Forceps .....	62
Lamont Nasal Rasp .....	199	McIndoe Rasp .....	193, 197, 201
Lanes Tissue Forceps .....	56	McIndoe Scissors .....	240
Lariche Forceps .....	106	McInnis Polycurette Breast Instrument .....	22
Larsen Tendon Forceps .....	81	McIvor Mouth Gag .....	142
Laschal Suture Scissors-Forceps .....	250	McKenty Septum Elevator .....	37



McKenty Sphenoid Punch Forceps ..... 94, 339  
 McKissock Keyhole Pattern..... 305  
 McKissock Mammoplasty Caliper..... 305  
 Mead Mallet ..... 163  
 Meade Wire Cutting Pliers ..... 286  
 Measuring, Abdominal ..... 309  
 Measuring, Breast ..... 304-306  
 Measuring, Face ..... 307-308  
 Measuring Instruments ..... 299-303  
 Medicine/Iodine cups ..... 359  
 Metzenbaum Needle Holder ..... 182  
 Metzenbaum Scissors ..... 211, 217, 218, 225, 245  
 Meyerding Finger Retractor ..... 131  
 Meyerhoefer Curette ..... 19  
 Micro Alligator Ear Forceps ..... 85, 322  
 Micro Boley Gauge ..... 301  
 Micro Forceps ..... 72, 73, 74  
 Micro Needle Holder..... 183  
 Micro Scissors ..... 251  
 Micro Surgery Needle Holders ..... 172, 175, 183  
 Micro Suture Forceps..... 72  
 Micro Vascular Needle Holder ..... 172, 175, 183  
 Microsurgical Plastic Trays ..... 371  
 Middleton-Jansen Septum Forceps ..... 98, 342  
 Millard-Dingman Mouth Gag ..... 142  
 Millard Thimble Hook..... 115  
 Millard Thumb Hook ..... 114-115  
 Miller Bone File..... 202  
 Miller-Colburn File ..... 202  
 Miller Dissecting Scissors ..... 253  
 Miller Rake Retractor ..... 125  
 Miltex BiopBlade, Sterile ..... 349  
 Miltex Ear Forceps ..... 84, 321  
 Miltex Elevator..... 34  
 Miltex EZ-Zyme All Purpose Enzyme Cleaner ..... 364  
 Miltex Indicator Tape ..... 376  
 Miltex Instrument Care & Cleaning Products ..... 364-367  
 Miltex Instrument Care Kit System ..... 366  
 Miltex Instrument Care Training DVD ..... 367  
 Miltex Instrument Lubricant ..... 365  
 Miltex Instrument Prep Enzyme Foam ..... 364  
 Miltex Instrument Storage System ..... 370  
 Miltex Iris Scissors..... 241  
 Miltex Mallets..... 163  
 Miltex Nylon Brushes ..... 366  
 Miltex Punch Rongeur ..... 96, 341  
 Miltex Sinus Cup Forceps ..... 89, 334  
 Miltex Spray Lube ..... 365  
 Miltex Stainless Steel Brushes ..... 366  
 Miltex Steam Indicator Strips ..... 376  
 Miltex Sterilization Cases ..... 373  
 Miltex Sterilization Trays..... 372  
 Miltex Stitch Scissors ..... 249  
 Miltex Surgical Instrument Cleaner ..... 364  
 Miltex Surgical Instrument Cleaner & Lubricant..... 365  
 Miltex Surgical Instrument Stain Remover ..... 366  
 Miltex Utility Scissors..... 249  
 Mini-Osteotomes ..... 7  
 Mini Three Jaw Wire Forming Pliers ..... 294  
 Mitchell Trimmer ..... 42  
 Mixter Forceps ..... 103  
 Molt Dissector and Raspatory..... 38  
 Molt Elevator..... 34  
 Morselizer, Cartilage ..... 165-166  
 Morselizer, Septum ..... 166  
 Mosby Utility Scissors..... 248  
 Mosquito Forceps..... 101, 102, 105  
 Mount Vernon Hospital Pattern Dissecting Forceps ..... 62

Mouth Gag Retractors ..... 141-143  
 Mouth Prop..... 144  
 Mustarde Dissecting Forceps..... 70  
 Mustarde Suture Forceps ..... 70  
 Myringotomy Knife ..... 328

**N**

Nance Wire Forming Pliers ..... 296  
 Nasal Biopsy Forceps ..... 92, 337  
 Nasal Cartilage Scissors ..... 257  
 Nasal Chisels ..... 2  
 Nasal & Dissecting Scissors..... 219  
 Nasal Elevators ..... 34  
 Nasal Forceps..... 87-98, 332-341, 343  
 Nasal Fracture Elevator ..... 34, 343  
 Nasal Instruments ..... 268-272  
 Nasal Knives ..... 155  
 Nasal Osteotomes ..... 7, 11  
 Nasal Packing, Disposable..... 271, 356  
 Nasal & Plastic Surgery Scissors ..... 255  
 Nasal Rasps ..... 193, 194, 196-200  
 Nasal Retractors..... 118, 127, 128, 136, 137, 316  
 Nasal Scissors..... 217, 219, 230, 233, 252, 255-258, 260, 264, 342  
 Nasal Specula..... 147-148  
 Nasal Splints..... 269  
 Nasal Tenaculum Hook ..... 113  
 Nasal Tip Sizers..... 268  
 Nasostat, Sterile ..... 269, 354  
 Needle Holder/Clamp ..... 178  
 Needle Holders, Left Handed..... 170, 171, 172  
 Needle Holders, Micro Surgery ..... 172, 175, 183  
 Needle Holders, Single-Use..... 353  
 Needle Holders, Stainless Steel ..... 179-183  
 Needle Holders, Tungsten Carbide..... 169-178  
 Needle Holders with Scissors ..... 170, 173, 174, 179, 182, 239  
 Needles ..... 185-186, 327  
 Needles, Suture..... 185  
 Neivert Needle Holder ..... 173, 181  
 Neivert Osteotome..... 8  
 Nelson Scissors ..... 226  
 Nelson Tissue Forceps ..... 64  
 Nerve Retractors ..... 121, 125  
 Nigro-Hamra Septum Forceps ..... 98  
 Nipper, Ear ..... 321  
 Noble-Mayo Scissors..... 244  
 Noe-Webster Needle Holder..... 182  
 Non-Perforated Mayo Trays ..... 360  
 Nostril Retractor..... 146  
 Nova Jaw Hook ..... 117  
 Novark Knife Handle ..... 151  
 Nylon Brushes ..... 366

**O**

O'Brien Scissors..... 250  
 O'Brien Wire Forming Pliers..... 294  
 Obwegeser Awls ..... 186  
 Obwegeser-Freer Elevator ..... 39  
 Obwegeser Mandibular Strippers ..... 29  
 Ochsner-Rochester Forceps ..... 104  
 Office & Lab Pliers ..... 291  
 Old Style Looping Pliers..... 297  
 Olmstead Tissue Forceps ..... 59  
 Olsen-Hegar Needle Holder..... 170, 179  
 Omega Loop Forming Pliers ..... 292  
 Operating Scissors ..... 218, 224, 246  
 Orbital Retractor ..... 124  
 Oringer Lip Retractor..... 144  
 Orthopedic Hand..... 274, 275

Ortiz-Monasterio Scissors .....	261	Pin & Wire Instrumentation, Pliers .....	291-297
Osteotomes .....	6-11	Pin & Wire Instrumentation, Tungsten Carbide.....	286-290
Osteotomes, Bayonet .....	10	Pin & Wire Puller .....	288
Osteotomes, Maxillofacial .....	10	Pitanguy Flap Grasping Forceps.....	79
Osteotomes, Nasal .....	7, 11	Pitanguy Large Flap Demarcator .....	309
Ostrum Punch.....	95, 340	Pitanguy Osteotome .....	11
Otobrader .....	331	Pitanguy Small Flap Demarcator .....	308
Owsley Face Lift Scissors .....	262	Planas T Osteotome .....	11
<b>P</b>		Plaster & Cast Shears .....	266
Packing, Ear.....	270, 355	Plastic Surgery Scissors .....	255
Packing, Nasal.....	271, 356	Plastic Trays w/ Mats .....	371
Packing, Sinus .....	272, 357	Platysma Scissors .....	216, 220, 229
Padgett Blepharoplasty Scissors .....	231	Platysmaplasty Set.....	390
Padgett Cleft Palate Rasp.....	201	Pliers .....	290-297
Padgett-Deaver Retractor.....	130	Polk Finger Goniometer.....	273, 302
Padgett-Deaver Retractor, Fiber Optic .....	316	Pollock-Dingman Displacer.....	35
Padgett Dissecting Scissors .....	217	Pollock-Dingman Utility Forceps .....	64
Padgett Iris Scissors .....	230, 241, 242	Post Nasal Biopsy Forceps .....	92, 335
Padgett Mallets .....	161, 163	Potts-Smith Bipolar Forceps.....	76
Padgett Mosquito Forceps.....	102, 105	Potts-Smith Dressing Forceps .....	48, 57
Padgett Nasal Cartilage Scissors.....	257	Potts-Smith Scissors .....	257
Padgett Nasal Rasp .....	193	Potts-Smith Tissue Forceps .....	57
Padgett Nasal Scissors.....	217	Prentis Rongeur .....	15
Padgett Osteotome .....	9	Probes .....	187-190
Padgett Pliers .....	290	Providence Hospital Hemostat.....	102
Padgett Rubber Magnetic Mat.....	374	Ptois Forceps .....	69
Padgett-Rubin Morselizer .....	165	Punch Forceps.....	93-96, 338-341, 344
Padgett S Retractor.....	131	Punch Rongeurs .....	96, 341
Padgett Scissors .....	217, 230, 231, 247, 248, 257	Punches, Dermal.....	280, 248
Padgett Septal Scissors .....	230	Push Retractor .....	138
Padgett Stevens Tenotomy Scissors .....	232, 247	<b>Q</b>	
Padgett Stitch Scissors .....	247	Quimby Scissors.....	235
Padgett Strabismus Scissors.....	224, 248	Quisling Hammer.....	161
Padgett Suture Scissors .....	247	<b>R</b>	
Padgett Swivel Double Hook/Retractor .....	127	Ragnell-Kleinert Retractor .....	119
Padgett Turbinate Scissors.....	263	Ragnell Retractor.....	119
Palate Hook.....	111	Ragnell Scissors.....	223, 259
Pantzer Bandage Scissors .....	265	Rake Retractors .....	120, 122, 125, 126, 132-134
Paparella-Weitlaner Retractor.....	136, 324	Raney Clip Applying Forceps.....	78
Par Needle Holder .....	173	Raney Clips.....	78
Par Scissors.....	214, 222, 227	Rankin Hemostat.....	105
Parkes Gouge .....	12	Rasps.....	193-201
Parkes Rasp .....	194, 199	Rasps, Cleft Palate.....	200, 201
Parkhouse Needle Holder.....	174	Rasps, Double Ended.....	193, 195, 198, 199, 200
Passers .....	191	Rasps, Finishing.....	195
Passers, Suture .....	191	Rasps, Glabellar.....	193, 196, 197
Patton Scissors .....	262	Rasps, Nasal.....	193, 194, 196-200
Pean-Rochester Forceps.....	104	Rasps, Tungsten Carbide .....	193-195
Peck-Joseph Scissors .....	231	Read Elevator.....	30, 32
Peeso Pliers.....	291	Reduction Instrument .....	136
Peet-Aufricht Rasp .....	196	Reed Dressing Forceps .....	67
Peet-Cottle Rasp.....	196	Reeh Scissors .....	249
Peet Rasp.....	195, 196	Rees Dressing Forceps .....	50
Pen.....	303	Rees Osteotome.....	7
Penn Breast Dissector .....	21	Rees Scissors.....	227, 261
Pennington Septum Elevator.....	35, 38	Reidy Nasal Rasp .....	199
Perforated Mayo Trays.....	360	Repair/Return Instructions .....	382
Periosteal Dissectors.....	29	Replacement Fiber Optic Adapters .....	318
Periosteal Elevators.....	30, 32-34, 38-39	Retractor, Mamaplasty.....	139, 313
Pickett Fine Dissecting Scissors.....	237	Retractors .....	118-140, 311-316, 324
Pickrell-Cottle Elevator .....	42	Retractors, Breast .....	139, 313
Picks.....	326	Retractors, Cheek.....	144-146
Pierce Dissector.....	21	Retractors, Ear.....	164, 324
Pin Cutter .....	287	Retractors, Eye .....	124
Pin Puller .....	288	Retractors, Face Lift.....	132-134, 140, 312, 314
Pin & Wire Cutter .....	287	Retractors, Fiber Optic.....	311-316
Pin & Wire Instrumentation.....	286-297		

Retractors, Flap.....	129, 315
Retractors, Insulated.....	122-123
Retractors, Lid.....	122, 123
Retractors, Lip.....	144-145
Retractors, Mouth Gags.....	141-143
Retractors, Nasal.....	118, 127, 128, 136, 137, 146, 316
Retractors, Nerve.....	121, 125
Retractors, Rhinoplasty.....	137
Retractors, Self Retaining.....	135-137, 141-145, 324
Retractors, Specula.....	147-148
Retractors, Vein.....	125
Retractros, Rake.....	120, 122, 125, 126, 132-134
Reverdin Suture Needle.....	185
Reverse Curve Adenoid Curette.....	344
Reynolds Breast Dissector.....	27
Reynolds Scissors.....	215, 221, 240
Reynolds Wire Forming Pliers.....	291
Rhinoplasty Retractors.....	137
Rhinoplasty Set.....	392
Rhytidectomy Scissors.....	212-216, 219-221, 228-229, 232, 234, 237, 251, 252, 259-262
Rhytidectomy Set.....	390
Ribbon Retractor.....	130, 131
Rish Osteotome.....	8
Rochester-Ochsner Forceps.....	104
Rochester-Pean Forceps.....	104
Roger Elevator.....	35
Rollet-Knapp Retractor.....	125
Rongeurs.....	13-15
Rongeurs, Bone.....	13-17
Rongeurs, Double Action.....	13-17
Rosen Knife Curette.....	18, 325
Rosen Picks.....	326
Rosen Suction Tube.....	283, 329
Rosen Suction Tube Adapter.....	283, 329
Rotating Back-Biting Forceps, Nasal.....	93, 338
Rowe Bone Elevator.....	32
Rowe Forceps.....	82
Rowland Nasal Hump Forceps.....	16
Rozner Osteotome.....	7
Rubber Mat, Magnetic.....	374
Rubin Morselizer.....	165
Rubin Osteotome.....	11
Rubin-Wright Septum Morselizer.....	166, 342
Ruler.....	299
Ruskin Bone Rongeur.....	15
Ruskin-Liston Bone Cutting Forceps.....	17
Ruskin Nasal Hump Forceps.....	16
Ryder Needle Holder.....	175
Ryder-Type Intracardiac Needle Holder.....	176

**S**

S Retractor.....	131
Saalfeld Comedone Extractor.....	279
Saber-Back, Fomon scissors.....	222, 227-229, 231, 233, 235, 238, 252, 258-261, 263
Safety Scalpels, Disposable.....	350
Salinger Reduction Instrument.....	39, 136
Sarot Needle Holder.....	177
Saws.....	204-205
Scalpel Handle.....	150, 151
Scalpels, Disposable.....	350-352
Schamberg Comedone Extractor.....	279
Schuknecht Suction Tube.....	284, 330
Scissors.....	206-266, 323, 342
Scissors, Alligator.....	264, 323
Scissors, Bandage.....	265, 266
Scissors, Blepharoplasty.....	231, 232, 254

Scissors, Cartilage.....	236, 238, 252, 257
Scissors, Ceramic.....	211-213
Scissors, Cleft Palate.....	235, 253
Scissors, Converse.....	233, 257
Scissors, Dissecting.....	211, 217-219, 235, 237-238, 240, 243-245, 251, 253, 256, 258-259, 261-262
Scissors, Dorsal.....	214, 222, 224, 253
Scissors, Ear.....	323
Scissors, Face Lift.....	212-216, 219-221, 228-229, 232, 234, 237, 251, 252, 259-262
Scissors, Gum.....	235
Scissors, Iris.....	211, 217, 218, 230, 231, 241-243
Scissors, Lateral.....	222, 263
Scissors, Mayo.....	211, 218, 226, 244, 245
Scissors, Metzenbaum.....	211, 217, 218, 225, 245
Scissors, Micro.....	251
Scissors, Nasal.....	217, 219, 230, 233, 252, 255-258, 260, 264, 342
Scissors, Needle Holder w/ Scissors.....	239
Scissors, Operating.....	218, 224, 246
Scissors, Plastic Surgery.....	250, 255
Scissors, Platysma.....	216, 220, 229
Scissors, Rhytidectomy.....	212-216, 219-221, 228-229, 232, 234, 237, 251, 252, 259-262
Scissors, Septum.....	230, 254
Scissors, Single-Use.....	353
Scissors, Stitch.....	239, 247, 249-251
Scissors, Strabismus.....	211, 224, 248, 258
Scissors, SuperCut.....	218-223
Scissors, SuperCut/Tungsten Carbide.....	214-217
Scissors, Suture.....	239, 243, 247, 248, 250, 265, 290
Scissors, Tenotomy.....	214, 223, 232, 240, 247
Scissors, Tissue.....	214, 217, 218, 222, 237
Scissors, Tonsil.....	243
Scissors, Tungsten Carbide.....	224, 233
Scissors, Turbinate.....	229, 252, 255, 263
Scissors, Undermining.....	259
Scissors, Utility.....	248, 249
Scissors, Z-Type.....	234
Sealy Plastic Scissors.....	255
Seldin Elevator.....	34
Self Retaining Retractors.....	135-137, 141-145, 324
Semken Dressing Forceps.....	58
Semken Tissue Forceps.....	58
Senn Retractor.....	121
Septum Chisels.....	3, 4
Septum Elevators.....	35-38
Septum Forceps.....	80
Septum Knives.....	154
Septum Morselizer.....	166
Septum Scissors.....	230, 254
Septum Speculum.....	148
Service & Repairs.....	382
Set, Abdominoplasty.....	385
Set, Blepharoplasty.....	384
Set, Breast Augmentation.....	386-389
Set, Face & Neck Combination.....	390-391
Set, Facial Implant.....	390-391
Set, Forehead Lift.....	390-391
Set, Gruber Rhinoplasty.....	392-393
Set, Inframammary.....	386
Set, Periareolar.....	386
Set, Platysmaplasty.....	390-391
Set, Rhinoplasty.....	392-393
Set, SMASectomy.....	390-391
Set, Transaxillary.....	388
Set, Transumbilical Breast Augmentation (TUBA).....	389
Set, Tummy Tuck.....	385



Shaw Retractor.....	121
Shea Speculum Holder.....	331
Sheehan Chisel/Osteotome.....	6
Sheehan-Gillies Needle Holder.....	182
Sheehy-House Knife Curette.....	18, 325
Sheen Cartilage Forceps, Bayonet.....	99
Sheen Grid.....	268, 303
Sheen Gripping Forceps.....	64
Sheen-Killian Septum Forceps.....	99
Sheen Nasal Retractor.....	127
Sheen Osteotome.....	10
Sheen Retractor.....	127
Sherman Mallet.....	163
Shoe Horn Retractor.....	145
Sickle Knife.....	328
Side-Biting Forceps.....	93, 338
Siegel Scalpel Handle.....	151
Silicone Coated Blades.....	152, 352
Silicone Mats for Storage Cassettes.....	370
Silitone™ Color Bands.....	368
Silver Chisel.....	2
Silver Skin Graft Knife.....	159
Silverstein Breast Dissector.....	28
Simal Rib Forceps.....	80
Sims Scissors.....	256
Single-Use Instruments, Sterile.....	353
Sinus Cup Forceps.....	89, 334
Sinus Packing, Disposable.....	272, 357
Skin Graft Knives.....	159
Skin Marking Pen.....	303
Skin Retractor.....	128
Slimline Cassettes.....	370
Small Plastic Tray.....	371
Small Plastic Tray with Silicone Mat.....	268
SMAsectomy Set.....	390
Smith Corneal Shield.....	124
Solution Basins.....	359
Specula, Nasal.....	147-148
Speculum Holder.....	331
Spencer Scissors.....	250
Sphenoid Punch Forceps.....	94, 339
Splinter Forceps.....	71
Sponge Bowls.....	359
Sponge Holding Forceps.....	107
Spray Lube.....	365
Spring Bow Dividers.....	301
Spring Retractor.....	135
Stain Guide.....	379
Stainless Steel Blades.....	152, 352
Stainless Steel Brushes.....	366
Stainless Steelware.....	359-361
Standard Scissors.....	235-266
St. Clair-Thompson Adenoid Forceps.....	86, 344
Steam Indicator Strips.....	376
Sterile Blades.....	159
Sterilization Cases.....	373
Sterilization Products.....	376
Sterilization Trays.....	372
Stevens Tenotomy Scissors.....	214, 223, 232, 247
Stille-Horsely Bone Cutting Forceps.....	17
Stille Tissue Forceps.....	59
Stitch Scissors.....	239, 247, 249-251
Strabismus Scissors.....	211, 224, 248, 258
Straight Skin Hook.....	112
Stratte Needle Holder.....	177
Stringers.....	362, 374-375
Strippers, Tendon.....	277
Stylet for Suction Nasal Forceps.....	87, 92, 332, 337
Subcutaneous Tissue Retractor.....	122
Submucosal Dissectors.....	21
Suction Dissectors.....	21
Suction Handle.....	124
Suction Irrigation Tubes.....	284, 330
Suction Nasal Forceps.....	87, 332
Suction Tubes.....	282-284, 329-330
SuperCut Scissors.....	218-223
SuperCut/Tungsten Carbide Scissors.....	214-217
Surgi-Brush, Sterile.....	354, 366
Surgical Blades, Disposable.....	152, 352
Surgical Blade-Safe, Surgical Blade Remover.....	152, 352
Surgical Hand Table.....	273
Surgical Instrument Cleaner.....	364
Surgical Instrument Cleaner & Lubricant.....	365
Surgical Instrument Stain Remover.....	366
Surgi-Clamp, Plastic.....	354
Suture Forceps.....	45, 46, 70, 71, 72
Suture Needles.....	185
Suture Passers.....	191
Suture Scissors.....	239, 243, 247, 248, 250, 265, 290
Suture Wire.....	286
Suture Wire Cutting Scissors.....	233, 290
Swedish Needle Holder.....	174
Swivel Double Hook/Retractor.....	127
<b>T</b>	
Takahashi Nasal Forceps.....	97, 335
Tape N' Tell Adhesive Strips.....	368
Tape, Indicator.....	376
Taylor Dural Scissors.....	260
TBTS-Style Breast Dissectors.....	23
TBTS-Style Endoplastic Retractor.....	312
TBTS-Style Fiber Optic Retractors.....	311
Tenaculum Nasal Hook.....	113
Tendon Forceps.....	81, 82
Tendon Strippers.....	277
Tenotomy Scissors.....	214, 223, 232, 240, 247
Terms & Conditions.....	381
Terry Nasal Retractor.....	136
Tessier Maxillofacial Osteotome.....	10
Tessier Periosteal Elevator.....	39
Thackray Dental Packing Forceps.....	67
Thimble Hooks.....	115
Thin Point Scissors.....	258
Thomas Iris Scissors.....	242
Thompson-St Clair Adenoid Forceps.....	86, 344
Thorek Scissors.....	257
Thorpe Caliper.....	299
Three Jaw Wire Forming Pliers.....	292
Three Prong NiTi Bender Pliers.....	297
Thudichums Nasal Speculum.....	147
Thumb Dressing Forceps.....	56
Thumb Hooks.....	114-115
Thumb Tissue Forceps.....	55
Tieck-Halle Nasal Speculum.....	147
Tip Sizers.....	268
Tip-It Instrument Protectors.....	75, 369
Tissue Forceps.....	45, 46, 51, 52, 53, 54, 55, 56, 57, 58, 59, 60, 63, 64, 65, 78
Tissue Scissors.....	214, 217, 218, 222, 237
Tongue Blade.....	141, 345
Tongue Seizing Forceps.....	106
Tonsil Needles.....	186, 346
Tonsil Scissors.....	243
Towel Forceps.....	100
Transaxillary Breast Augmentation Set.....	386
Transumbilical Breast Augmentation Instruments.....	24, 25, 26

Troutman-Barraquer Mini Blade Breaker & Holder ..... 153  
 Tsur Open Rhinoplasty Retractor ..... 137  
 TUBA (Transumbilical) Breast Augmentation Set ..... 387  
 TUBA Instruments ..... 24, 25, 26  
 Tumbler ..... 359  
 Tummy Tuck Set ..... 385  
 Tungsten Carbide Forceps ..... 44-50  
 Tungsten Carbide Needle Holders ..... 169-178  
 Tungsten Carbide Rasps ..... 193-195  
 Tungsten Carbide Scissors ..... 224-234  
 Tuning Forks ..... 331  
 Turbinate Scissors ..... 229, 252, 255, 263  
 Tweed Loop Forming Pliers ..... 293  
 Tympanoplasty Knife ..... 328  
 Tyrell Hook ..... 109

**U**

U.S. Army Retractor ..... 129  
 Undermining Scissors ..... 259  
 Ungaro-Mancusi Scissors ..... 237  
 Universal Cassette ..... 370  
 Unna Comedone Extractor ..... 278  
 USF Debriding Forceps ..... 159  
 Utility Forceps ..... 64  
 Utility Scissors ..... 248, 249

**V**

Vascular Needle Holders ..... 172, 175, 183  
 Vein Retractors ..... 125  
 Verdi Cleft Palate Scissors ..... 235  
 Vienna Speculum ..... 148  
 Vinas Cleft Palate Scissors ..... 253  
 Volkman Scoop ..... 18  
 Von Graefe Tissue Forceps ..... 64  
 VonEicken Antrum Cannula ..... 282  
 V-Stop Wire Forming Pliers ..... 296

**W**

Walden-Marshall Scissors ..... 258  
 Walker Iris Scissors ..... 243  
 Walsham Septum Straightening Forceps ..... 80  
 Walsham Septum Straightening Forceps ..... 99  
 Walter Splinter Forceps ..... 71  
 Wangenstein Needle Holder ..... 178  
 Ward Osteotome ..... 7  
 Warranty ..... 380  
 Washer ..... 306  
 Watson Skin Graft Knife ..... 159  
 Waugh Dissecting Forceps ..... 61  
 Webster Needle Holder ..... 172, 180, 182  
 Webster-Noe Needle Holder ..... 182  
 Weil-Blakesley Forceps ..... 90, 337  
 Weil Nasal Forceps ..... 90, 335  
 Weitlaner-Paparella Retractor ..... 136, 324  
 West Gouge ..... 12  
 Wieder Tongue Depressor ..... 143  
 Wieslander Breast Dissector ..... 27  
 Wilde-Blakesley Ethmoid Forceps ..... 88, 333  
 Wilde Dressing Forceps ..... 68  
 Wilde Forceps ..... 97  
 Wilde Nasal Forceps ..... 89, 334  
 Wilkinson Scissors ..... 214, 261  
 William-House Suction - Irrigation Tubes ..... 284, 330  
 Williams-Hayton Maxillary fracture Forceps ..... 82  
 Williams Lacrimal Probes ..... 188  
 Wilmer Scissors ..... 233  
 Wire Bending Pliers ..... 291  
 Wire Brush ..... 201

Wire Closure Forceps ..... 84, 321  
 Wire Cutting ..... 233, 265, 286-287, 290  
 Wire Forming Pliers ..... 292-295  
 Wire Pliers ..... 291-297  
 Wire Twister ..... 169, 289  
 Wire Twisting Forceps ..... 83  
 Wire, Suture ..... 286  
 Wise Orbit Retractor ..... 124  
 Worst Pigtail Probe ..... 190  
 Wrap, Autoclave ..... 371  
 Wrap, CSR ..... 376  
 Wright-Rubin Morselizer ..... 166, 342

**Y**

Yancoskie Abdominoplasty Retractor ..... 133  
 Yancoskie Coronal Lift Retractor ..... 132  
 Yankauer Suction Tube ..... 283  
 Young Tongue Seizing Forceps ..... 106

**Z**

Z-Type Scissors (TC) ..... 234  
 Zarem-Baylis Eyelid Retractor ..... 123  
 Zygomatic Elevators ..... 32

017-31610.....	145	3-552.....	373	3-2502C.....	75, 369
017-31611.....	145	3-554.....	373	3-2502T.....	75, 369
017-31620.....	145	3-570.....	373	3-2502V.....	75, 369
017-31621.....	145	3-572.....	373	3-2503.....	75, 369
017-31622.....	145	3-574.....	373	3-2503C.....	75, 369
017-48220.....	368	3-576.....	373	3-2503T.....	75, 369
017-48221.....	368	3-700.....	365	3-2503V.....	75, 369
017-48222.....	368	3-705.....	365	3-2504.....	75, 369
017-48223.....	368	3-710.....	365	3-2504C.....	75, 369
017-48224.....	368	3-720.....	364	3-2504T.....	75, 369
017-48225.....	368	3-725.....	364	3-2504V.....	75, 369
017-48226.....	368	3-740.....	366	3-2505.....	75, 369
017-48227.....	368	3-750.....	364	3-2505C.....	75, 369
017-48230.....	368	3-755.....	364	3-2505T.....	75, 369
2-60.....	106	3-760.....	364	3-2505V.....	75, 369
2-62.....	106	3-800.....	366	3-2506.....	75, 369
2-104SS.....	283, 286-391	3-810.....	367	3-2506C.....	75, 369
2-106SS.....	283	3-900.....	359	3-2506T.....	75, 369
2-115.....	141, 345, 394, 395	3-901.....	359	3-2506V.....	75, 369
2-116.....	141, 345	3-902.....	359	3-2507.....	75, 369
2-117.....	141, 345	3-903.....	359	3-2507C.....	75, 369
2-118.....	141, 345	3-904.....	359	3-2507T.....	75, 369
2-130.....	142	3-905.....	359	3-2507V.....	75, 369
2-132.....	142	3-906.....	359	3-2508.....	75, 369
2-134.....	142	3-907.....	359	3-2508C.....	75, 369
2-136.....	142	3-908.....	359	3-2508T.....	75, 369
2-138.....	142	3-909.....	359	3-2508V.....	75, 369
2-154.....	143	3-910.....	359	3-2509.....	75, 369
2-160.....	143	3-912.....	359	3-2509C.....	75, 369
2-162.....	143	3-913.....	359	3-2509T.....	75, 369
2-164.....	143	3-914.....	359	3-2509V.....	75, 369
2-180.....	142	3-915.....	360	3-2510.....	75, 369
2-182.....	142	3-916.....	360	3-2510C.....	75, 369
3-072007.....	370	3-917.....	360	3-2510T.....	75, 369
3-072014.....	370	3-918.....	360	3-2510V.....	75, 369
3-082008.....	370	3-919.....	360	3-200100.....	372
3-20.....	107	3-920.....	360	3-200200.....	372
3-22.....	107	3-921.....	360	3-200300.....	372
3-24.....	107	3-922.....	360	4-008115.....	370
3-26.....	107	3-924.....	360	4-008122.....	370
3-60.....	374	3-925.....	360	4-008122MAT.....	370
3-70.....	362, 375	3-926.....	360	4-009126.....	370
3-71.....	362, 375	3-927.....	360	4-009126MAT.....	370
3-72.....	362, 375	3-929.....	360	4-083000.....	370
3-74.....	362, 375	3-930.....	360	4-083000MAT.....	370
3-75.....	362, 375	3-934.....	360	4-084000.....	370
3-76.....	362, 375	3-935.....	360	4-084000MAT.....	370
3-77.....	362, 375	3-936.....	360	4-085000.....	370
3-78.....	362, 375	3-937.....	361	4-085000MAT.....	370
3-79.....	362, 375	3-938.....	361	4-089100.....	370
3-80.....	362, 375	3-939.....	361	4-089100MAT.....	370
3-81.....	362, 375	3-940.....	361	4-7.....	150, 384-389
3-82.....	362, 375	3-941.....	361	4-8.....	150
3-83.....	362, 375	3-942.....	361	4-9.....	151
3-84.....	362, 375	3-943.....	361	4-10.....	150
3-85.....	362, 375	3-944.....	361	4-11.....	150
3-86.....	362, 375	3-945.....	361	4-16.....	150
3-87.....	362, 375	3-946.....	361	4-17.....	151, 390
3-88.....	362, 375	3-947.....	361	4-18.....	151
3-89.....	362, 375	3-948.....	361	4-100.....	152, 352
3-90.....	362, 375	3-949.....	361	4-110.....	152, 352
3-91.....	362, 375	3-953.....	360	4-111.....	152, 352
3-92.....	362, 375	3-954.....	360	4-112.....	152, 352
3-93.....	362, 375	3-955.....	360	4-112B.....	152, 352
3-94.....	362, 375	3-1000.....	366	4-115.....	152, 352
3-95.....	362, 375	3-1001.....	201, 366	4-115C.....	152, 352
3-96.....	362, 375	3-2501.....	75, 369	4-120.....	152, 352
3-97.....	362, 375	3-2501C.....	75, 369	4-121.....	152, 352
3-98.....	362, 375	3-2501T.....	75, 369	4-122.....	152, 352
3-99.....	362, 375	3-2501V.....	75, 369	4-123.....	152, 352
3-550.....	373	3-2502.....	75, 369	4-125.....	152, 352

4-310 .....	152, 352	5-124 .....	244	5-249B .....	257
4-311 .....	152, 352	5-124TC .....	226	5-249C .....	257
4-312 .....	152, 352	5-SC-124 .....	218	5-263 .....	254
4-312B .....	152, 352	5-126 .....	244	5-264 .....	243, 394, 395
4-315 .....	152, 352	5-126TC .....	226	5-265 .....	259
4-315C .....	152, 352	5-SC-126 .....	218	5-266 .....	259
4-320 .....	152, 352	5-128TC .....	226	5-267 .....	259
4-321 .....	152, 352	5-SC-128 .....	218	5-268 .....	259
4-322 .....	152, 352	5-130TC .....	226	5-269TC .....	232
4-323 .....	152, 352	5-SC-130 .....	218	5-270 .....	255
4-325 .....	152, 352	5-136 .....	245	5-SC-270 .....	219
4-410 .....	351	5-136TC .....	226	5-271 .....	255
4-411 .....	351	5-138 .....	245	5-272 .....	255
4-412 .....	351	5-138TC .....	226	5-273 .....	255
4-415 .....	351	5-140 .....	245	5-274 .....	255
4-420 .....	351	5-140TC .....	226	5-275 .....	255
4-421 .....	351	5-142 .....	245	5-276 .....	255
4-422 .....	351	5-142TC .....	226	5-SC-276 .....	219
4-423 .....	351	5-144 .....	244	5-277 .....	255
4-510 .....	350	5-146 .....	244	5-278 .....	255
4-511 .....	350	5-148 .....	244	5-279 .....	255
4-512 .....	350	5-150 .....	244	5-280 .....	255
4-515 .....	350	5-172 .....	240	5-281 .....	255
4-515C .....	350	5-174 .....	240	5-283 .....	245
4-522 .....	350	5-176 .....	240	5-SC-283 .....	218
4-6815 .....	370, 384	5-178 .....	240	5-284 .....	245
4-6815MAT .....	370, 384	5-179 .....	245	5-SC-284 .....	218
4-6835 .....	370	5-179A-TC .....	225	5-286 .....	245
4-6835MAT .....	370	5-179B-TC .....	225	5-288 .....	245
5-2 .....	246	5-179TC .....	225	5-SC-290 .....	223
5-4 .....	246	5-SC-179 .....	218	5-300 .....	241
5-6 .....	246	5-180 .....	245	5-302 .....	241
5-6TC .....	224	5-180A-TC .....	225	5-304 .....	241
5-7 .....	246	5-180B-TC .....	225	5-304TC .....	231
5-8 .....	246	5-180TC .....	225	5-SC-304 .....	218
5-12 .....	246	5-SC-180 .....	218	5-SC-304TC .....	217
5-14 .....	246	5-181 .....	245, 390, 391	5-306 .....	241
5-16 .....	246	5-181A-TC .....	225	5-306TC .....	231, 294, 295
5-16TC .....	224	5-181B-TC .....	225	5-SC-306 .....	218
5-SC-16 .....	218	5-181TC .....	225	5-SC-306TC .....	217
5-17 .....	246	5-182 .....	245	5-308 .....	241
5-18 .....	246	5-182A-TC .....	225	5-312 .....	258
5-22 .....	246	5-182B-TC .....	225	5-312TC .....	224
5-24 .....	246	5-182TC .....	225	5-314 .....	258
5-26 .....	246	5-SC-182 .....	218	5-314TC .....	224
5-26TC .....	224	5-SC-182TC .....	217	5-316 .....	260
5-27 .....	246	5-183 .....	245	5-318 .....	260
5-28 .....	246	5-184TC .....	225	5-320TC .....	234
5-32 .....	246	5-185 .....	245	5-SC-320 .....	223
5-34 .....	246	5-186 .....	245	5D-326 .....	260
5-36 .....	246	5-186TC .....	225	5-400 .....	249
5-36TC .....	224	5-187 .....	245	5-510 .....	266
5-37 .....	246	5-187TC .....	225	5-512 .....	266
5-38 .....	246	5-188 .....	245	5-514 .....	266
5-42 .....	246	5-188TC .....	225	5-516 .....	266
5-44 .....	246	5-SC-188 .....	218	5-550 .....	266
5-46 .....	246	5-189 .....	245	5-560 .....	266
5-46TC .....	224	5-189A-TC .....	225	5-561 .....	266
5-SC-46 .....	218	5-189TC .....	225	5-568 .....	266
5-48 .....	246	5-190 .....	245	6-2 .....	56
5-52 .....	246	5-192 .....	245, 388, 389	6-4 .....	56
5-54 .....	246	5-192TC .....	226	6-6 .....	56
5-56 .....	246	5-193A-TC .....	226	6-8 .....	56
5-56TC .....	224	5-194 .....	388, 389	6-10 .....	56
5-58 .....	246	5-222 .....	256	6-12 .....	56
5-120 .....	244	5-244 .....	257	6-14 .....	56, 386, 387
5-120TC .....	226	5-245 .....	257	6-16 .....	56
5-SC-120 .....	218	5-246 .....	257	6-18 .....	56
5-122 .....	244	5-247 .....	257	6-26 .....	56
5-122TC .....	226	5-248 .....	257	6-30 .....	47
5-SC-122 .....	218	5-249A .....	257	6-40 .....	55

6-42.....	55	7-44.....	103	8-51.....	179
6-44.....	55	7-46.....	103	8-51TC.....	171
6-46.....	55, 385	7-48.....	103	8-52.....	179
6-47.....	55	7-66.....	104	8-52TC.....	171
6-48.....	55, 386, 387, 394, 395	7-68.....	104	8-53.....	179
6-50.....	55	7-92.....	105	8-53TC.....	171
6-52.....	55	7-94.....	105	8-55TC.....	171
6-104.....	58	7-102.....	104	8-57TC.....	171
6-106.....	58	7-118.....	104	8-58.....	182
6-107.....	58	7-136.....	104	8-59.....	182
6-108.....	58	7-150.....	104	8-62TC.....	174
6-109.....	58	7-160.....	104	8-63TC.....	174
6-109A.....	58	7-240.....	105	8-65TC.....	176
6-110.....	59	7-242.....	105, 390, 391	8-66TC.....	176
6-112.....	52	7-280.....	101	8-67TC.....	176
6-113TC.....	46	7-282.....	101	8-69TC.....	176
6-114.....	52	7-290.....	101	8-74.....	182
6-115TC.....	46	7-292.....	101	8-76.....	182
6-118.....	51	7-500.....	101	8-82TC.....	176
6-118TC.....	45	7-501.....	101	8-83TC.....	176
6-118XL.....	51	7-504.....	100	8-96TC.....	177
6-120.....	51	7-506.....	100	8-100TC.....	177
6-120A.....	53	7-514.....	100	8-101TC.....	175
6-120XL.....	51	7-515.....	100	8-102TC.....	177
6-121.....	51, 385, 390, 391	7-600.....	107	8-103TC.....	175
6-122.....	51	7-602.....	107	8-104TC.....	175
6-123.....	51	7-604.....	107	8-105TC.....	175
6-123TC.....	45	7-606.....	107	8-106TC.....	175
6-123XL.....	51	8-3TC.....	173	8-107TC.....	175
6-124.....	53	8-4.....	180	8-114TC.....	177
6-124TC.....	46	8-4TC.....	171	8-130.....	179
6-124XL.....	53	8-5TC.....	173	8-130TC.....	170
6-127.....	54	8-6.....	180	8-134TC.....	178
6-129TC.....	45	8-6TC.....	172, 385-389, 394, 395	8-706TC.....	172
6-130TC.....	45	8-7.....	180	8-744TC.....	170
6-138.....	54	8-7A-TC.....	172	8-746TC.....	170
6-140.....	54	8-7TC.....	172, 384	8-748TC.....	170
6-154.....	57	8-8.....	181	8-750TC.....	171
6-154TC.....	48	8-8A-TC.....	172	8-751TC.....	171
6-156.....	57	8-8TC.....	172	8-752TC.....	171
6-156TC.....	48	8-12.....	181	8-753TC.....	171
6-158.....	57	8-14.....	179	9-44-18.....	286
6-158TC.....	48	8-14A.....	179	9-44-20.....	286
6-160.....	57	8-14A-TC.....	170	9-44-22.....	286
6-162.....	57	8-14TC.....	170	9-44-24.....	286
6-164.....	57	8-15.....	179	9-44-25.....	286
6-165TC.....	48	8-15TC.....	170	9-44-26.....	286
6-166.....	58	8-16.....	179	9-44-28.....	286
6-166TC.....	47	8-16TC.....	170	9-44-30.....	286
6-168.....	57	8-17.....	179	9-44-32.....	286
6-192.....	65, 390, 391	8-17TC.....	170	9-44-34.....	286
6-198TC.....	50	8-20.....	180	9-96.....	239
6-300.....	71	8-22.....	181	9-100.....	250
6-302.....	71	8-23.....	181	9-110.....	250
6-304.....	71	8-28TC.....	176	9-115.....	249
6-312.....	71	8-30TC.....	176	9-116.....	249
6-314.....	71	8D-36.....	181	9-117.....	249
6-316.....	71	8-40.....	179	9-124.....	265, 290
6-318.....	71	8-40TC.....	169	9-124TC.....	233, 290
7-2.....	101	8-42.....	179	10-2-NS.....	189
7-4.....	101, 390, 391	8-42TC.....	170	10-2-ST.....	189
7-14.....	101	8-44.....	179	10-4-NS.....	189
7-16.....	101	8-44TC.....	170	10-4-ST.....	189
7-20.....	101	8-46.....	179	10-6-NS.....	189
7-24.....	102	8-46TC.....	170	10-6-ST.....	189
7-26.....	102, 384	8-48.....	179	10-8-NS.....	189
7-30.....	102	8-48TC.....	170	10-8-ST.....	189
7-32.....	102	8-49TC.....	170	10-10-NS.....	189
7-36.....	103	8-50.....	179	10-10-ST.....	189
7-38.....	103	8-50A-TC.....	171	10-12-NS.....	189
7-42.....	103	8-50TC.....	171	10-12-ST.....	189

10-14-NS.....	189	17-303C.....	72	18-1428.....	242
10-14-ST.....	189	17-304.....	73	18-1440TC.....	233
10-22-SS.....	188	17-305.....	73	18-1455.....	247
10-22-ST.....	188	17-307.....	73	18-1456.....	247
10-24-SS.....	188	17-307X.....	73	18-1460.....	247
10-24-ST.....	188	17-980.....	183	18-1462.....	247
10-26-SS.....	188	17-1000.....	183	18-1464.....	247
10-26-ST.....	188	17-1010.....	183	18-1466.....	247
10-28-SS.....	188	17-1020.....	183	18-1470.....	247
10-28-ST.....	188	17-1024.....	183	18-SC-1470.....	223
10-30-SS.....	188	17-1025.....	183	18-1472.....	247
10-30-ST.....	188	17-2100.....	251	18-SC-1472.....	223
10-32-SS.....	188	17-2110.....	251	18-1474.....	247
10-32-ST.....	188	17-2150.....	251	18-SC-1474.....	223
10-34-SS.....	188	17-2160.....	251	18-1476.....	247, 392-393
10-34-ST.....	188	17-2500.....	51	18-SC-1476.....	223, 385, 394, 395
10-69.....	189	17-2510.....	51	18-SC-1652.....	219
10-70.....	189	18-100.....	125	18-1653.....	243
10-72.....	189	18-102.....	126	18-1820.....	183
10-74.....	189	18-110.....	122	18-1824.....	183
10-76.....	189	18-112.....	122	18-1828.....	183
10-79.....	189	18-114.....	122	18-1828A-TC.....	175
10-80.....	189	18-116.....	122	18-1828TC.....	175
10-82.....	189	18-170.....	153	18-1831.....	183
10-84.....	189	18-171.....	153	18-1832.....	183
11-14.....	135	18-172.....	153	18-1832A-TC.....	175
11-16.....	135	18-120.....	123	18-1832TC.....	175
11-30.....	120	18-412.....	109	18-1833.....	183
11-32.....	120	18-414.....	109	18-1960.....	3
11-34.....	120	18-416.....	110	18-1968.....	36, 384
11-36.....	120	18-498.....	19	18-1997.....	96, 341
11-38.....	120	18-499.....	19	19-60.....	331
11-40.....	120	18-500.....	19	19-100.....	331
11-50.....	120	18-502.....	19	19-102.....	331
11-52.....	120	18-504.....	19	19-104.....	331
11-54.....	120	18-506.....	19	19-106.....	331
11-56.....	120	18-650.....	300, 384, 394, 395	19-108.....	331
11-58.....	120	18-657.....	299, 392-393	19-110.....	331
11-60.....	120	18-658.....	299	19-112.....	331
11-73.....	119, 392, 393	18-660.....	299	19-113.....	331
11-74.....	121, 386, 388, 389	18-710.....	187	19-115.....	331
11-76.....	121	18-712.....	187	19-117.....	331
11-78.....	145	18-714.....	187	19-120.....	331
11-80.....	122	18-716.....	187	19-120A.....	331
11-81.....	122	18-718.....	187	19-211.....	326
11-88.....	131	18-720.....	187	19-212.....	326
11-90.....	131	18-722.....	188	19-320.....	354
11-92.....	131	18-724.....	188	19-321.....	354
11-94.....	131	18-726.....	188	19-322.....	354
11-96.....	131	18-728.....	188	19-323.....	354
11-102.....	125	18-730.....	188	19-350.....	68
11-110.....	129	18-732.....	188	19-370.....	67, 392-393
11-112.....	129	18-740.....	187	19-415.....	83, 320
11-122.....	129, 385-391	18-742.....	187	19-416.....	83, 320
11-130.....	131, 389	18-744.....	187	19-417.....	84, 321
11-132.....	131	18-746.....	187	19-418.....	84, 321
11-134.....	131	18-748.....	187	19-420.....	83, 320
11-136.....	131	18-750.....	187	19-421.....	83, 320
11-140.....	131	18-795.....	66	19-422.....	83, 320
11-144.....	130	18-795A.....	66	19-480.....	84, 321
11-146.....	130, 386-387	18-796.....	60	19-481.....	84, 321
11-240.....	385	18-798.....	60	19-505.....	18, 325
11-625.....	136, 324	18-1138.....	69	19-506.....	18, 325
12-80.....	78, 385	18-1200.....	69	19-530.....	283, 329
16-3.....	78	18-1202.....	69	19-531.....	283, 329
16-4.....	78	18-1204.....	69	19-532.....	283, 329
16-6.....	390-391	18-1396.....	241	19-533.....	283, 329
16-10.....	385	18-1398.....	241	19-534.....	283, 329
17-301.....	72	18-1420.....	242	19-535.....	283, 329
17-302.....	74	18-1422.....	242	19-536.....	283, 329
17-303.....	72	18-1426.....	242	19-537.....	283, 329

19-538	283, 329	19-2511	326	20-553	165-166, 342
19-539	283, 329	19-2512	326	20-554	98, 342
19-540	283, 329	19-2513	326	20-556	98, 342
19-541	283, 329	19-2514	326	20-557	98, 342
19-550	284, 330	19-2515	326	20-558	94, 339
19-551	284, 330	19-2516	326	20-559	94, 339
19-552	284, 330	19-2517	326	20-560	94, 339
19-553	284, 330	19-2518	42, 324	20-565	88, 333
19-554	284, 330	19-2520	42, 324	20-566	89, 334
19-555	284, 330	19-2522	158, 328	20-567	90, 335
19-557	284, 330	19-2523	158, 328	20-568	90, 335
19-558	284, 330	19-2524	158, 328	20-570	97, 335
19-559	284, 330	19-2525	158, 328	20-572	97, 335
19-562	284, 330	19-2526	158, 328	20-575	97, 335
19-563	284, 330	19-2527	158, 328	20-576	97, 335
19-564	284, 330	19-2528	18, 325	20-577	97, 335
19-565	284, 330	19-2529	18, 325	20-580	97
19-570	282	19-2530	18, 325	20-582	97
19-572	282	20-2	148	20-584	97
19-573	282	20-3	148	20-585	89, 334
19-574	282	20-4	148	20-586	89, 334
19-575	282, 384, 390, 391	20-6	148	20-587	88, 333
19-576	282	20-7	148	20-588	88, 333
19-577	282, 386, 387	20-12	147	20-589	88, 333
19-585	284, 330	20-28	148	20-594	98
19-586	284, 330	20-29	148, 392-393	20-596	98
19-790	161	20-30	148	20-598	98
19-792	162	20-32	148, 392-393	20-600	89, 334
19-793	163	20-36-35	147	20-601	89, 334
19-794	163	20-36-50	147	20-602	89, 334
19-795	163	20-36-75	147	20-605	90, 335
19-796	163	20-36-90	147	20-606	88, 333
19-797	163	20-37-45	147	20-607	88, 333
19-844	13	20-37-75	147	20-608	88, 333
19-848	15	20-120	68	20-609	88, 333
19-849	15	20-170	264, 342	20-699	93, 338
19-850	15	20-171	264, 342	20-700	93, 338
19-852	15	20-172	264, 342	20-701	93, 338
19-854	15	20-200	154	20-702	93, 338
19-856	15	20-202	154, 392-393	20-703	93, 338
19-1341	34, 324	20-216	155	20-704	93, 338
19-2000	270, 355	20-218	155	20-705	93, 338
19-2002	270, 355	20-220	155	20-706	96, 341
19-2004	270, 355	20-222	155	20-707	96, 341
19-2081	85, 322	20-224	155	20-708	95, 340
19-2081-B	85, 322	20-230	21	20-709	95, 340
19-2090	85, 322	20-238	35	20-710	95, 340
19-2090-B	85, 322	20-240	36, 343	20-711	95, 340
19-2100	85, 322	20-242	38	20-712	90, 337
19-2100-B	85, 322	20-246	35, 38, 394, 395	20-713	90, 337
19-2110	85, 322	20-258	35	20-714	90, 337
19-2110-B	85, 322	20-270	3	20-715	90, 337
19-2114	83, 320	20-274	11	20-716	90, 337
19-2115	85, 322	20-278	6	20-717	90, 337
19-2116	85, 322	20-280	6	20-810	344
19-2117	83, 320	20-282	6	20-811	344
19-2118	83, 320	20-284	6	20-812	344
19-2119	83, 320	20-426	186, 346	20-813	344
19-2155	264, 323	20-427	186, 346	20-814	344
19-2156	264, 323	20-456	282	20-929	86, 344
19-2157	264, 323	20-470	87, 332	20-930	86, 344
19-2158	264, 323	20-471	87, 332	20-1000	92, 337
19-2159	264, 323	20-472	87, 332	20-1002	92, 337
19-2160	264, 323	20-473	87, 332	20-1004	92, 337
19-2500	186, 327	20-474	87, 332	20-1006	92, 337
19-2501	186, 327	20-475	87, 332	20-1008	92, 337
19-2502	327	20-476	87, 332	20-1010	91, 336
19-2503	327	20-477	87, 332	20-1012	91, 336
19-2504	18, 325	20-478	87, 92, 332, 337	20-1014	91, 336
19-2505	326	20-550	166, 342	20-1016	91, 336
19-2510	326	20-552	165	20-1018	91, 336



20-1020 .....	91, 336	21-205-6 .....	6	21-661 .....	97
20-1022 .....	91, 336	21-205-8 .....	6	21-710TC .....	228
20-1024 .....	91, 336	21-205-10 .....	6	21-SC-710 .....	221
20-1026 .....	91, 336	21-205-12 .....	6	21-SC-711 .....	221
20-1028 .....	91, 336	21-205-15 .....	6	21-715TC .....	229
20-1030 .....	91, 336	21-206-4 .....	4	21-SC-715 .....	220
20-1032 .....	91, 336	21-206-7 .....	4	21-SC-716 .....	220
20-1034 .....	95, 340	21-206-9 .....	4	21-734 .....	304
20-1036 .....	95, 340	21-206-12 .....	4	21-736 .....	304
20-1038 .....	95, 340	21-212 .....	4	21-738 .....	304
20-1040 .....	95, 340	21-215 .....	9	21-740TC .....	228
20-1042 .....	95, 340	21-216 .....	9	21-742 .....	304
20-1044 .....	95, 340	21-217 .....	9	21-742TC .....	228
20-1095 .....	92, 337	21-218 .....	9	21-745 .....	304
20-3000 .....	271, 356	21-227 .....	2	21-SC-745 .....	222
20-3002 .....	271, 356	21-228 .....	2	21-750 .....	304
20-3004 .....	271, 356	21-229 .....	2	21-838 .....	305
20-3006 .....	271, 356	21-232 .....	8, 392-393	21-842 .....	305
20-3010 .....	271, 356	21-233 .....	8	21-845 .....	305
20-3012 .....	271, 356	21-234 .....	8	21-900 .....	186
20-3014 .....	271, 356	21-280 .....	204, 392, 393	21-901 .....	186
20-3020 .....	270, 355	21-282 .....	204, 392-393	21-902 .....	186
20-3022 .....	270, 355	21-284 .....	204, 392-393	22-2 .....	143
20-3030 .....	272, 357	21-288 .....	204	22-4 .....	143
20-3032 .....	272, 357	21-290 .....	204	22D-209 .....	390, 391
20-3034 .....	272, 357	21-300 .....	164	22-210 .....	144
20-3036 .....	272, 357	21-338 .....	196	22-480 .....	13
20-3038 .....	272, 357	21-342 .....	198	22-482 .....	13
20-3040 .....	272, 357	21-343 .....	198	22-500TC .....	169, 289
20-3042 .....	272, 357	21-346 .....	197	22-502TC .....	169, 289
21-2 .....	155	21-348 .....	197	22-662 .....	394, 395
21-4 .....	155	21-352 .....	200	23-12-4 .....	394, 395
21-16 .....	155	21-354 .....	200	23-12-5 .....	394, 395
21-18 .....	155	21-368 .....	199	24-550 .....	63
21-50 .....	29, 390-391	21-369 .....	199	24-552 .....	63
21-51 .....	29, 390-391	21-370 .....	199, 392-393	24-554 .....	63
21-52 .....	29, 390-391	21-379 .....	201, 366	24-570 .....	63
21-53 .....	29, 390-391	21-380TC .....	195	24-570XL .....	63
21-60 .....	40	21-381TC .....	195	24-572 .....	63
21-61 .....	34, 343	21-382TC .....	195	24-574 .....	63
21-62 .....	37	21-383TC .....	195	25-384 .....	17
21-63 .....	37	21-384TC .....	194	25-385 .....	17
21-64 .....	33	21-385TC .....	194	25-396 .....	17
21-65 .....	35, 343	21-386TC .....	194	26-119 .....	205
21-68 .....	33	21-387TC .....	194	26-120 .....	205
21-72 .....	40	21-388TC .....	194	26-122 .....	205
21-85 .....	112	21-389TC .....	194	26-130 .....	205
21-86 .....	112	21-390TC .....	194	26-132 .....	205
21-87 .....	112	21-391TC .....	194	26-461 .....	15
21-88 .....	111	21-392DC .....	195	26-462 .....	15
21-89 .....	111, 390, 391	21-393DC .....	195	26-466 .....	15
21-107 .....	115	21-394TC .....	193	26-590 .....	78
21-108 .....	115	21-440 .....	69	26-591 .....	78
21-123 .....	134	21-537TC .....	231	26-1084 .....	109, 384
21-124 .....	133	21-558 .....	235	26-1086 .....	109
21-125 .....	134	21-600 .....	263	26-1352 .....	121
21-126 .....	134	21-SC-600 .....	222	26-1354 .....	121
21-127 .....	134	21-602 .....	263	27-144 .....	273, 302
21-128 .....	134	21-604 .....	253	27-159TC .....	287
21-129 .....	132	21-604TC .....	224	27-161TC .....	287
21-130 .....	133	21-607 .....	252	27-163TC .....	287
21-144 .....	118	21-SC-607 .....	219	27-164TC .....	288
21-153 .....	110	21-608 .....	252	27-165TC .....	288
21-154 .....	110, 384, 394, 395	21-608TC .....	229	27-176TC .....	288
21-156 .....	110, 392-395	21-SC-608 .....	219	27-180 .....	276
21-158 .....	110	21-610 .....	253	27-1016 .....	81
21-160 .....	110, 385-393	21-612 .....	260	27-1020 .....	277
21-163 .....	126	21-621 .....	255	27-1022 .....	277
21-180 .....	121	21-622 .....	254	27-1024 .....	277
21-205-2 .....	6	21-624 .....	16	27-1026 .....	277
21-205-4 .....	6	21-628 .....	16	27-1028 .....	277



27-1297 .....	14	40-1371 .....	203	FLM-125 .....	102, 385-389
27-1390 .....	16	40-1375 .....	203	FLM-130 .....	102
27-1392 .....	16	40-1380 .....	203	FLM-135 .....	102
27-1400 .....	16	40-1381 .....	203	FLM-140 .....	102
27-1402 .....	16	40-1382 .....	203	FLM-145 .....	102
29-18-32 .....	386-387	40-1385 .....	203	FLM-275 .....	103
29-102 .....	388-389	40-2800 .....	203	PM-0058 .....	144
29-310TC .....	178	405043 .....	354, 366	PM-0062 .....	144
30-2101TC .....	234	41900 .....	269, 354	PM-0064 .....	144
30-2102TC .....	234	41901 .....	269, 354	PM-0278 .....	60
30-2103TC .....	234	41902 .....	269, 354	PM-0280 .....	60
30-2105TC .....	234	41903 .....	269, 354	PM-0284 .....	60
30-2106TC .....	234	4610 .....	152, 352	PM-0286 .....	61
30-2107TC .....	234	4611 .....	152, 352	PM-0288 .....	61
30-2109TC .....	234	4615 .....	152, 352	PM-0290 .....	65
30-2110TC .....	234	62-20 .....	5	PM-0292 .....	63
30-2111TC .....	234	62-21 .....	5	PM-0300 .....	67
33-2 .....	19	62-22 .....	5	PM-0302 .....	62
33-3 .....	19	62-23 .....	5	PM-0306 .....	61
33-4 .....	19	62-40 .....	5	PM-0314 .....	56
33-5 .....	19	62-41 .....	5	PM-0316 .....	56
33-5A .....	19	62-42 .....	5	PM-0320 .....	56
33-5B .....	19	62-43 .....	5	PM-0322 .....	56
33-20 .....	280	62-44 .....	5	PM-0326 .....	63
33-22 .....	280	62-45 .....	5	PM-0330 .....	62
33-24 .....	280	62-70 .....	164	PM-0332 .....	62
33-25 .....	280	68-694 .....	301	PM-0334 .....	62
33-26 .....	280	68-695 .....	301	PM-0336 .....	70
33-28 .....	280	68-696 .....	301	PM-0337 .....	70
33-30 .....	280	68-697 .....	301	PM-0344 .....	61
33-30-1 .....	280	68-699 .....	300	PM-0346 .....	61
33-30-2 .....	280	73-62 .....	34	PM-0348 .....	61
33-30-3 .....	280	74-10 .....	291	PM-0350 .....	61
33-30-4 .....	280	74-35 .....	291	PM-0404 .....	236
33-30-5 .....	280	74-40 .....	291	PM-0406 .....	236
33-30-6 .....	280	74-45 .....	291	PM-0407 .....	236
33-30-7 .....	280	74-55 .....	292	PM-0408 .....	236
33-31 .....	348	74-75 .....	292	PM-0410 .....	236
33-31-P/25 .....	348	74-301 .....	292	PM-0416 .....	236
33-31A .....	348	74-303 .....	292	PM-0418 .....	236
33-31A-P/25 .....	348	74-305 .....	293	PM-0422 .....	238
33-31AA .....	348	74-306 .....	293	PM-0424 .....	238
33-31AA-P/25 .....	348	74-307 .....	293	PM-0428 .....	238
33-31B .....	348	74-308 .....	293	PM-0430 .....	238
33-32 .....	348	74-309 .....	294	PM-0432 .....	238
33-32-P/25 .....	348	74-310 .....	294	PM-0434 .....	239
33-33 .....	348	74-311 .....	294	PM-0438 .....	239
33-34 .....	348	74-312 .....	294	PM-0440 .....	239
33-34-P/25 .....	348	74-316 .....	295	PM-044402 .....	7
33-35 .....	348	74-317 .....	295	PM-044404 .....	7
33-36 .....	348	74-318 .....	295	PM-044406 .....	7
33-37 .....	348	74-319 .....	296	PM-044408 .....	7
33-38 .....	348	74-320 .....	296	PM-044410 .....	7
33-52 .....	349	74-321 .....	296	PM-044412 .....	7
33-53 .....	349	74-322 .....	297	PM-044422 .....	7
33-54 .....	349	74-324 .....	297	PM-044424 .....	7
33-55 .....	349	74-330 .....	297	PM-044426 .....	7
33-57 .....	349	DELM9 .....	34, 390-391	PM-044428 .....	7
33-100 .....	349	DELS23 .....	34	PM-044430 .....	7
33-200 .....	279	EM-2151 .....	318	PM-044432 .....	7
33-201 .....	279	EM-2151BRACK .....	318	PM-0448 .....	240
33-202 .....	279	EM-2151LS .....	317	PM-0450 .....	240
33-204 .....	279	EM-2151STAND .....	318	PM-0452 .....	240
33-206 .....	279	EM-2155 .....	318	PM-0456 .....	240
33-210 .....	278	EM-2156 .....	318	PM-0460 .....	245
33-214 .....	278	EM-2157 .....	318	PM-0462 .....	245, 385-389
33-215 .....	278	FLM-100 .....	102	PM-0464 .....	245
35-601 .....	389	FLM-105 .....	102	PM-0470 .....	245
35-604 .....	388	FLM-110 .....	102	PM-0472 .....	245
374201 .....	354	FLM-115 .....	102	PM-0474 .....	245
40-1370 .....	203	FLM-120 .....	102	PM-0502 .....	136

PM-0504	116	PM-1546-5	7	PM-2321	171
PM-0505	116	PM-1554A	2	PM-2322	172, 394, 395
PM-0536	114, 392-393	PM-1554B	2	PM-2322SJ	172
PM-0538	114	PM-1632	10	PM-2325	171
PM-0542	116	PM-1634	10	PM-2350	171
PM-0552-1/2	128	PM-1684	276	PM-2360	171
PM-0552-3/8	128	PM-1686	276	PM-2400	171
PM-0562	128	PM-1688	277	PM-2404	173
PM-0564	109	PM-1690-4	277	PM-2405	172
PM-0566	109	PM-1690-5	277	PM-2406	175
PM-0598	128	PM-1730	145	PM-2410	172
PM-0630	268, 392, 393	PM-1754	142	PM-2410LH	172
PM-0642	106	PM-1786	186	PM-2414	173
PM-0676	299, 385-391	PM-1788	186	PM-2415	172, 384, 388-389
PM-0678	299	PM-180	371	PM-2415LH	172
PM-0688	303	PM18-1220	69	PM-2416	175
PM-0690	303	PM-195	157	PM-2420	173
PM-0695	185	PM-2	237	PM-2424	174
PM-0732-1	282	PM-200	81	PM-2425	173
PM-0732-2	282	PM-201	81	PM-2426	174
PM-0732-3	282	PM-202	81	PM-2430	171
PM-110	142, 346	PM-203	81	PM-2431	172
PM-1170-0	147	PM-210	277	PM-2435	171, 390-391
PM-1170-1	147	PM-229	191	PM-2435LH	171
PM-1170-2	147	PM-2031	193	PM-2440	175
PM-1170-3	147	PM-2032	193	PM-2441	175
PM-1170-4	147	PM-2033	193	PM-2442	175
PM-1246	82	PM-2034	193	PM-2445	175
PM-1250L	82	PM-2035	193	PM-2446	175
PM-1250R	82	PM-2105	193	PM-2447	175
PM-1266	32	PM-2110	169	PM-2500	45
PM-1284L	200, 394, 395	PM-2120	170, 385-391	PM-2501	45
PM-1284R	200, 394, 395	PM-2121	169, 289	PM-2503	45
PM-1292D	200, 394, 395	PM-2122	169, 289	PM-2505	45
PM-1292U	200, 394, 395	PM-2123	169, 289	PM-2510	47
PM-1296	201	PM-2130	170	PM-2511	46
PM-1298	31, 394, 395	PM-2140	170	PM-2520	47
PM-1302	31, 394, 395	PM-2145	170	PM-2525	50
PM-1304	31	PM-2160	170, 392-393	PM-2530	48
PM-1306L	201	PM-2165	170, 392-393	PM-2610	224
PM-1306M	201, 394, 395	PM-2169	170	PM-2620	224
PM-1306S	201, 394, 395	PM-2170	170	PM-2630	224
PM-1312	42, 394, 395	PM-21SC607CTC	213	PM-2700	224
PM-1320	30	PM-21SC608CTC	213	PM-2701	224
PM-1322	32	PM-21SC710CTC	212	PM-2705	230
PM-1422	17	PM-21SC711CTC	212	PM-2706	230, 386-391
PM-1440	197	PM-21SC715CTC	213	PM-2710	225
PM-1442	197	PM-21SC716CTC	213	PM-2711	225
PM-1444	197	PM-21SC740CTC	212	PM-2712	225
PM-1444TC	193	PM-21960	25	PM-2720	225
PM-1445	198	PM-21961	25	PM-2722	225
PM-1448	198	PM-21962	26	PM-2725	224
PM-1448TC	194	PM-21963	26	PM-2750	225
PM-1450	198	PM-21964	25	PM-2751	225
PM-1452	198	PM-21965	26	PM-2752	225
PM-1454	199	PM-21966	26	PM-2760	225
PM-1455	196	PM-21967	26	PM-2761	225
PM-1456	196	PM-21968	26	PM-2790	225
PM-1457	196	PM-21969	26	PM-2791	225
PM-1458	196	PM-21970	24, 389	PM-2792	225
PM-1459	196	PM-2200	175	PM-2795	225
PM-14701	159	PM-2206	175	PM-2799	229
PM-1476A	18	PM-2211	166	PM-2800	226
PM-1476B	18	PM-2215	166	PM-2810	226
PM-1476C	18	PM-2216	166	PM-2820	226
PM-1492	162	PM-2220	175	PM-2830	226
PM-1502-5	8	PM-2231	29	PM-2835	224
PM-1502-7	8	PM-2232	29	PM-2837	230
PM-1502-9	8	PM-2233	29	PM-2838	230
PM-1520	7	PM-2290	175	PM-29065	232
PM-1546-3	7	PM-2320	171	PM-2908	232

PM-2911	227	PM-400	124	PM-4307	33
PM-2930	227	PM-405	79	PM-4308	33
PM-2940	234	PM-406	191	PM-4309	33
PM-2943	233	PM-407	32	PM-4310	33
PM-2946	227	PM-408	117	PM-4311	124, 384
PM-2950	233	PM-409	331	PM-4312	124
PM-2951	233	PM-420	117	PM-4315	122
PM-2955	233	PM-421	117	PM-4315IN	122
PM-2956	233	PM-425	150	PM-4316IN	122
PM-29765	228	PM-431	109	PM-4317IN	122
PM-2978	228	PM-443	150	PM-4320	123
PM-2979	228	PM-444	150, 392-393	PM-4321	79
PM-29865	228	PM-447	135	PM-4322	81
PM-2988	231	PM-448	150	PM-4323	69
PM-2990	231	PM-454	304	PM-4326	123
PM-2991	229	PM-460	269	PM-4329	123
PM-2992	229	PM-461	269	PM-4347	123, 384
PM-2993	229	PM-462	269	PM-4373	257
PM-2994	229	PM-463	269	PM-4395	197
PM-2996	229	PM-464	304, 386-389	PM-4396	197
PM-2997	229	PM-465	304, 386-389	PM-4398	161
PM-3	237	PM-466	304, 386-389	PM-4398R	161
PM-325	116	PM-467	304, 386-389	PM-4409	202
PM-360	269	PM-468	304	PM-4410	202
PM-361	269	PM-469	304	PM-4411	202
PM-362	269	PM-470	304	PM-4412	3
PM-363	269	PM-490	129	PM-4413	3
PM-390	307	PM-490FO	315	PM-4417	11
PM-391	307, 390-391	PM-491	129	PM-4419	12
PM-395	309	PM-491FO	315	PM-4425	36
PM-397	309, 385	PM-4105	135	PM-4427	21
PM-398	303	PM-4110	135	PM-4429	36
PM-3100	242	PM-4115	135	PM-4434	36
PM-3102	242	PM-4120	135	PM-4435	37
PM-3152	121	PM-4125	135	PM-4436	38
PM-3160	170	PM-4126	265	PM-4440	37
PM-3185	32	PM-4130	135	PM-4441	37
PM-3503	46	PM-4136	71	PM-4446	278
PM-3504	50	PM-4137	286	PM-4450	185
PM-3505	50	PM-4185	54	PM-4451	185
PM-3575	164	PM-4187	56	PM-4452	185
PM-3710	175	PM-4188	55	PM-4453	185
PM-3715	175	PM-4200	241	PM-4463	13
PM-3720	175	PM-4201	241	PM-4472	277
PM-3726	70	PM-4202	241	PM-4479	82
PM-3727	70, 384	PM-4205	130	PM-4480	275
PM-3731	70	PM-4212	59	PM-4481	185
PM-3738	79	PM-4213	66	PM-4482	185
PM-3755	268, 303	PM-4222	81	PM-4554	202
PM-3756	268, 303	PM-4224	81	PM-4565	277
PM-3779	161	PM-4225	81	PM-4570	130
PM-3780	161	PM-4240	70	PM-4570FO	315, 386-391
PM-3795	308	PM-4241	70	PM-4571	130, 315, 390-391
PM-3800	8	PM-4242	70	PM-4571FO	315
PM-3802	8	PM-4244	300	PM-4581	120
PM-3804	8	PM-4246	241	PM-4582	120
PM-3806	8, 392-393	PM-4247	241	PM-4596	159
PM-3808	8	PM-4249	241	PM-4597	159
PM-3813	6	PM-4250	241	PM-4597LH	159
PM-3814	6	PM-4264	147	PM-4598	159
PM-3815	6	PM-4266	65	PM-4608	246
PM-3817	6	PM-4270FO	316	PM-4618	246
PM-3818	6	PM-4275	148	PM-4635	243
PM-3819	165	PM-4278	67	PM-4638	247
PM-3825	21, 392-393	PM-4279	67	PM-4639	247
PM-3826	31	PM-4283	68	PM-4641	247
PM-3827	31	PM-4285	256	PM-4642	247
PM-3830	165	PM-4292	65	PM-4648	248
PM-3831	165	PM-4293	154	PM-4660	99
PM-3875	290	PM-4302	155	PM-4661	98
PM-4	237	PM-4306	33	PM-4662	98

PM-4670.....	148	PM-4877.....	199	PM-509.....	134
PM-4671.....	148	PM-4878.....	199	PM-509IL.....	134, 385
PM-4680.....	36	PM-4879.....	200	PM-518.....	133
PM-4681.....	55	PM-4880.....	198	PM-519.....	134
PM-4697.....	49	PM-4881.....	198, 392-393	PM-519IL.....	134, 385, 388-389
PM-4698.....	49	PM-4883.....	252	PM-520.....	133
PM-4699.....	49	PM-4889.....	253	PM-529.....	139
PM-4701.....	242	PM-4892.....	254	PM-529FO.....	313
PM-4702.....	242	PM-4898.....	308	PM-530.....	139
PM-4703.....	242	PM-4899.....	309	PM-530FO.....	313
PM-4704.....	242, 384	PM-4900.....	163	PM-550.....	35
PM-4706.....	248	PM-4902.....	254	PM-555.....	64
PM-4707.....	248	PM-4903.....	38	PM-565.....	132
PM-4709.....	183	PM-4908.....	70	PM-566.....	133, 385
PM-4718.....	248	PM-4909.....	70	PM-5001.....	306
PM-4719.....	59	PM-4911.....	252	PM-5002.....	306
PM-4739HK.....	190	PM-4912.....	191	PM-5003.....	306
PM-4739HL.....	190	PM-4913.....	191	PM-5005.....	306
PM-4740.....	190	PM-4928.....	74	PM-5006.....	306
PM-4741.....	119	PM-4930.....	243	PM-5010.....	124
PM-4742.....	119	PM-4931.....	243	PM-5012.....	124, 384
PM-4743.....	119	PM-4935.....	10	PM-5015.....	124
PM-4746.....	74	PM-4940.....	10	PM-5020.....	123, 384
PM-4749.....	74	PM-4944.....	305, 386-389	PM-5102.....	155
PM-4752.....	143	PM-4945.....	305, 386-389	PM-5103.....	155
PM-4762.....	9	PM-4946.....	305, 386-389	PM-5110.....	155
PM-4769.....	251	PM-4952.....	119	PM-5111.....	155
PM-4770.....	30	PM-4955.....	254	PM-5130.....	156
PM-4772.....	230, 385	PM-4956.....	251	PM-5131.....	156
PM-4773.....	230	PM-4957.....	251	PM-5160.....	156
PM-4775.....	14	PM-4958.....	251	PM-5165.....	156
PM-4776.....	15	PM-4959.....	68	PM-5166.....	156
PM-4784.....	14	PM-4969.....	251	PM-5210.....	109
PM-4791.....	60	PM-4971.....	39, 390-391	PM-5215.....	114
PM-4792.....	60	PM-4972.....	39, 390-391	PM-5220.....	109
PM-4793.....	60, 384	PM-4973.....	39, 390-391	PM-5225.....	110
PM-4807.....	131	PM-4974.....	39	PM-5226.....	110
PM-4808.....	42	PM-4977.....	39	PM-5347.....	110
PM-4809.....	66	PM-4978.....	39	PM-5360.....	111
PM-4810.....	9	PM-4979.....	11	PM-5372.....	112
PM-4811.....	9	PM-4981.....	10	PM-5381.....	120
PM-4812.....	9	PM-4982.....	8	PM-5405.....	118
PM-4813.....	9	PM-4983.....	9	PM-5410.....	118
PM-4814.....	9	PM-4984.....	163	PM-5411.....	118
PM-4815.....	9	PM-4984R.....	163	PM-5412.....	118
PM-4816.....	9	PM-4985.....	11	PM-5430.....	120
PM-4817.....	9	PM-4990.....	28, 388	PM-5435.....	120
PM-4818.....	9	PM-5.....	237	PM-5445.....	111
PM-4819.....	9	PM-55C124CTC.....	211	PM-5448.....	111
PM-4820.....	9	PM-55C180CTC.....	211	PM-5550.....	121
PM-4823.....	144	PM-55C182CTC.....	211	PM-5551.....	121
PM-4826.....	122	PM-55C304CTC.....	211	PM-5551FO.....	314, 390-391
PM-4828.....	9	PM-55C306CTC.....	211	PM-5615.....	138
PM-4829.....	125	PM-55C314CTC.....	211	PM-5625.....	138
PM-4830.....	9	PM-500A.....	112	PM-5705.....	128, 392, 393
PM-4831.....	252	PM-500B.....	112	PM-5750.....	135
PM-4835.....	275	PM-500C.....	112	PM-5751.....	135
PM-4837.....	253	PM-500D.....	112	PM-5775.....	117
PM-4841.....	265	PM-500E.....	112	PM-5990.....	28
PM-4842.....	59	PM-501A.....	113	PM-600.....	40, 394, 395
PM-4843.....	232	PM-501B.....	113	PM-601.....	40, 394, 395
PM-4844.....	251	PM-501E.....	113	PM-602.....	40, 394, 395
PM-4847.....	39, 136	PM-502A.....	113	PM-603.....	157, 394, 395
PM-4859.....	72	PM-502B.....	113	PM-604.....	157, 394, 395
PM-4860.....	72	PM-503.....	113	PM-605.....	154, 394, 395
PM-4861.....	252	PM-504A.....	114	PM-606.....	146
PM-4862.....	252	PM-504B.....	114	PM-607.....	146
PM-4863.....	252	PM-506.....	114	PM-614.....	146
PM-4865.....	27	PM-507.....	115	PM-625.....	21
PM-4868.....	14	PM-507W.....	115	PM-630.....	22
PM-4869.....	14	PM-508.....	116	PM-632.....	27

PM-634 .....	27	PM-6598 .....	263	PM-708 .....	2
PM-635 .....	22	PM-6645 .....	262	PM-710 .....	275
PM-636 .....	27	PM-6646 .....	262	PM-711 .....	7
PM-637 .....	22	PM-6720 .....	260	PM-712 .....	7
PM-638 .....	28	PM-6751 .....	250	PM-728 .....	136
PM-639 .....	28	PM-6760 .....	250	PM-740 .....	273
PM-649 .....	151	PM-6770 .....	250	PM-760 .....	138
PM-650 .....	151	PM-6780 .....	250	PM-775 .....	308
PM-652 .....	124	PM-6800 .....	218	PM-790 .....	156
PM-656 .....	30	PM-6801 .....	218	PM-7103 .....	104, 384
PM-657 .....	30	PM-6805 .....	218	PM-7411 .....	196
PM-666 .....	164, 392-393	PM-6806 .....	218	PM-7422 .....	196
PM-667 .....	164	PM-6810 .....	218, 385	PM-7426 .....	199
PM-670 .....	286	PM-6810TC .....	217	PM-7500 .....	3
PM-675 .....	145	PM-6811 .....	218, 386-389	PM-7502 .....	3
PM-680 .....	121	PM-6811TC .....	217	PM-7503 .....	3
PM-699 .....	140	PM-6812 .....	218	PM-7525 .....	11
PM-6105 .....	51, 390-393	PM-6812TC .....	217	PM-7526 .....	11
PM-6106 .....	51	PM-6813 .....	218	PM-7530 .....	4
PM-6115 .....	51	PM-6813TC .....	217	PM-7535 .....	11
PM-6121 .....	53	PM-6815 .....	218	PM-7536 .....	11
PM-6125 .....	53, 385-393	PM-6815TC .....	217	PM-7537 .....	11
PM-6126 .....	53	PM-6816 .....	218	PM-7570 .....	4
PM-6127 .....	52	PM-6816TC .....	217	PM-7572 .....	4
PM-6128 .....	52, 386-389	PM-6818 .....	219	PM-7574 .....	4
PM-6129 .....	52, 386-389	PM-6820 .....	219	PM-7595 .....	12
PM-6140 .....	67	PM-6821 .....	219	PM-7600 .....	6
PM-6190 .....	64	PM-6821TC .....	217	PM-7606 .....	6
PM-6195 .....	64	PM-6822 .....	221	PM-7655 .....	80
PM-6200 .....	64	PM-6822TC .....	217	PM-7665 .....	12
PM-6245 .....	55	PM-6825 .....	219	PM-7670 .....	12
PM-6290 .....	64	PM-6830 .....	219	PM-7740 .....	40, 392-393
PM-6295 .....	99	PM-6830TC .....	216	PM-7741 .....	40
PM-6415 .....	255	PM-6831 .....	219	PM-7760 .....	33, 392-393
PM-6416 .....	255	PM-6831TC .....	216	PM-7770 .....	201
PM-6420 .....	256	PM-6832 .....	220	PM-7771 .....	201
PM-6421 .....	256	PM-6832TC .....	216	PM-7800 .....	41, 394, 395
PM-6422 .....	231	PM-6833 .....	220	PM-7801 .....	41, 394, 395
PM-6435 .....	231, 384	PM-6833TC .....	216	PM-7802 .....	41
PM-6436 .....	232	PM-6834 .....	220	PM-7810 .....	125
PM-6450 .....	257	PM-6834TC .....	216	PM-7820 .....	144
PM-6451 .....	257	PM-6835 .....	220, 385-391	PM-7821 .....	144
PM-6475 .....	245	PM-6835TC .....	216	PM-7822 .....	144
PM-6480 .....	258	PM-6836 .....	220	PM-7830 .....	144
PM-6515 .....	236	PM-6836TC .....	216	PM-7831 .....	144
PM-6522 .....	258	PM-6840 .....	220	PM-7832 .....	144
PM-6530 .....	258	PM-6840TC .....	215	PM-7970 .....	19
PM-6535 .....	235	PM-6841 .....	220	PM-7989 .....	19
PM-6540 .....	259	PM-6841TC .....	215	PM-7996 .....	19
PM-6541 .....	259	PM-6842 .....	221	PM-7997 .....	19
PM-6548 .....	259	PM-6843 .....	221	PM-800 .....	157
PM-6549 .....	259	PM-6843TC .....	215	PM-801 .....	126
PM-6550 .....	235	PM-6845 .....	221	PM-805 .....	162, 392, 393
PM-6555 .....	259	PM-6845TC .....	215	PM-825 .....	126
PM-6560 .....	235	PM-6847 .....	221	PM-855 .....	273, 302
PM-6565 .....	260	PM-6847TC .....	215	PM-865 .....	127
PM-6573 .....	261	PM-6848 .....	221	PM-866 .....	137
PM-6574 .....	261	PM-6850 .....	222	PM-876 .....	137, 392-393
PM-6575 .....	261	PM-6851 .....	222	PM-877 .....	137, 392-393
PM-6576 .....	261	PM-6851TC .....	214	PM-878 .....	268, 392-393
PM-6580 .....	261	PM-6852 .....	222	PM-880 .....	127
PM-6581 .....	261	PM-6852TC .....	214	PM-881 .....	127
PM-6582 .....	262	PM-6855 .....	222	PM-882 .....	10
PM-6583 .....	262	PM-6855TC .....	214	PM-884 .....	140
PM-6585 .....	262	PM-6856 .....	222	PM-884FO .....	312
PM-6586 .....	227	PM-6856TC .....	214	PM-886 .....	127
PM-6587 .....	227	PM-6860 .....	223, 384	PM-890 .....	140
PM-6590 .....	262	PM-6860TC .....	214	PM-890FO .....	314, 386-387, 390-391
PM-6591 .....	257	PM-6862 .....	223	PM-895 .....	139
PM-6595 .....	252	PM-6863 .....	223	PM-895FO .....	313, 388
PM-6596 .....	263	PM-6873TC .....	214	PM-897FO .....	311

PM-898FO.....	311	ST5-180.....	353
PM-899FO.....	311, 386-387	ST5-182.....	353
PM-8200.....	99	ST5-304.....	353
PM-8210.....	80	ST5-306.....	353
PM-8220.....	80	ST5-504SS.....	353
PM-8221.....	80	ST6-8.....	353
PM-8222.....	80	ST6-44.....	353
PM-8223.....	80	ST6-118.....	353
PM-8335.....	182	ST6-120.....	353
PM-8411.....	185	ST7-138.....	353
PM-8412.....	185	ST7-2.....	353
PM-8413.....	185	ST7-4.....	353
PM-8414.....	185	ST7-36.....	353
PM-8585.....	106	ST7-38.....	353
PM-8625.....	105	ST7-42.....	353
PM-8626.....	105	ST7-44.....	353
PM-8630.....	105	ST8-6.....	353
PM-8631.....	105	ST8-44.....	353
PM-8632.....	159	ST8-50.....	353
PM-8670.....	82	ST9-102.....	353
PM-8750.....	305	STD1515.....	376
PM-8750.....	386, 388	STD2020.....	376
PM-900FO.....	311	STD2424.....	376
PM-901FO.....	311	STDDRY.....	376
PM-902FO.....	311	STDIND.....	376
PM-903FO.....	311	STDSL27.....	370
PM-904FO.....	311	STDSTEAM.....	376
PM-905.....	312	SURGHIPBOX.....	367
PM-909.....	23, 386-387	SURGHIPPOST.....	367
PM-909L.....	23	VST.....	368
PM-910.....	23	VSTA.....	368
PM-910L.....	23	VSTSA.....	368
PM-947.....	374	VSTSB.....	368
PM-949.....	371	VSTSD.....	368
PM-950.....	371	VSTSG.....	368
PM-961.....	274	VSTSK.....	368
PM-962.....	274	VSTSL.....	368
PM-963.....	274	VSTSN.....	368
PM-9015.....	235	VSTSP.....	368
PM-9019.....	157	VSTSR.....	368
PM-9031.....	307	VSTSU.....	368
PM-9043.....	48	VSTSW.....	368
PM-9054.....	28, 386-387	VSTSY.....	368
PM-9056.....	118		
PM-9057.....	130		
PM-9057FO.....	316		
PM-9312.....	305		
PM-9313.....	305		
PM-9323.....	268, 371, 392-393		
PM-9325.....	371		
PM-9326.....	371		
PM-9410.....	76		
PM-9411.....	76		
PM-9412.....	76		
PM-9420.....	76		
PM-9421.....	76, 394-395		
PM-9425.....	76		
PM-9430.....	76		
PM-9431.....	76		
PM-9435.....	76		
PM-9436.....	76, 390-391		
PM-9440.....	76		
PM-9445.....	77		
PM-9450.....	77		
PM-9450D.....	77		
PM-9472.....	77		
PM-9475.....	77		
PM-9500.....	137		
ST5-16.....	353		
ST5-120.....	353		
ST5-124.....	353		









[integralife.com/integra-miltex](http://integralife.com/integra-miltex)  
toll-free phone 866-854-8300  
toll-free fax 866-854-8400  
phone 717-840-9335  
fax 717-840-9347

**Please call Customer Service today for additional information, an in-office demonstration, to place an order, or to receive other Miltex catalogs.**

Padgett is a registered trademark of Integra LifeSciences Corporation.  
Integra and the Integra logo are trademarks of Integra LifeSciences Corporation.  
Miltex is registered trademark of Integra York PA, Inc., a subsidiary of Integra LifeSciences Corporation.  
Copyright ©2010 Integra LifeSciences Corporation

