



Integra™ Miltex®

Animal Health

Surgical and Dental Instruments



INTRODUCTION

This new Animal Healthcare Products Catalog demonstrates the Miltex® commitment to this clinician and their special patient population. We have assembled a significant array of Instrumentation to meet both the General and Specialty Surgical needs of this unique and diverse marketplace.

In addition to the premium Miltex® and Padgett® brands, we also illustrate a number of instrument grade choices and single-use products. These provide both quality and value options to our customers.

This Miltex® resolve to support Animal Health is both for now as well as in future product and service development initiatives. We look forward to increased cooperation to achieve goals of mutual benefit.

Tolerances in product specifications, due to the hand craftsmanship of the instruments, are subject to minor variations in dimensions and finishes.

CONTRIBUTING CLINICIANS
(LISTED IN ALPHABETICAL ORDER)





Brett Beckman, DVM, DAVDC, DAAPM

Diplomate, American Academy of Pain Management

*Diplomate, American Veterinary Dental College
Fellow, Academy of Veterinary Dentistry
President, American Veterinary Dental Society
Florida Veterinary Dentistry and Oral Surgery*

Dr. Brett Beckman is a 1987 graduate of Mississippi State University and is acting President of the American Veterinary Dental Society. Dr. Beckman holds advanced degrees as a Fellow in the Academy of Veterinary Dentistry, a Diplomate in the American Veterinary Dental College and a Diplomate in the American Academy of Pain Management. He has published numerous peer-reviewed articles in the field of veterinary dentistry, oral surgery and pain management. Dr. Beckman was honored as Alumnus of the Year by the Mississippi State University College of Veterinary Medicine in 2007. He owns and operates a companion animal and referral dentistry and oral surgery practice in Punta Gorda, Florida and sees referral cases at Affiliated Veterinary Specialists in Orlando, Florida and Cherokee Emergency in Atlanta. He lectures internationally on topics related to dentistry and pain management and operates the Veterinary Dental Education Center in Punta Gorda, Florida, a teaching facility dedicated to advancing the educational needs of veterinarians and veterinary technicians around the world in the field of dentistry and oral surgery. For seminar/wet lab information please go to www.veterinarydentistry.net

*Florida Veterinary Dentistry & Oral Surgery
Brett Beckman, DVM, FAVD, DAVDC, DAAPM
11002 Nathan Court
Punta Gorda, FL 339552
www.veterinarydentistry.net*



Robert S. Gaddis, Jr., DVM

Graduate, Auburn University College of Veterinary Medicine - 1983

Owner, Indian Springs Animal Clinic and Dental Referral Service located in Birmingham (suburbs), Alabama

Alternate Pathway Resident, American Veterinary Dental College

Dr. Gaddis is a 1983 graduate of Auburn University College of Veterinary Medicine. He owns and operates Indian Springs Animal Clinic and Veterinary Dental Referral Service in Birmingham, Alabama where his primary focus is veterinary dentistry. He is presently enrolled in the Alternate Pathway Residency Program of the American Veterinary Dentistry College and is also a member of the AVMA, Alabama VMA and the American Veterinary Dental Society. Dr. Gaddis enjoys teaching veterinary dentistry and has participated in lectures and labs in the southeast.

*Robert S. Gaddis, Jr., DVM
1583 Cahaba Valley Road
Pelham, AL 35124
205-988-8654*



Gary S. Goldstein, DVM, DAVDC

*Diplomate, American Veterinary Dental College
Fellow, Academy of Veterinary Dentistry*

Dr. Goldstein is an Associate Clinical Professor, Director of the Veterinary Dental Service and Associate Medical Director of the University of Minnesota Veterinary Medical Center.

He graduated from the University of Minnesota School of Veterinary Medicine in 1984. After graduation, he moved to Houston, Texas to study veterinary dentistry at the Houston Veterinary Dental Clinic under the direct supervision of Dr. Donald Ross. In 1988 he joined Gulf Coast Veterinary Specialists where his practice was limited to veterinary dentistry accepting referrals for the entire Gulf Coast region. In 1987 Dr. Goldstein became a Charter Fellow in the Academy of Veterinary Dentistry and in 1992 became Board Certified in Veterinary Dentistry.

He joined the faculty at the University of Minnesota College of Veterinary Medicine as an associate clinical professor in the veterinary clinical sciences department in April 2000. He teaches veterinary students in the classroom as well as in clinics and his staff see over 1500 cases per year.

Dr. Goldstein is a published author and lecturer, offers dental seminars throughout the country, has published numerous articles and has written several chapters in veterinary textbooks.

*Gary S. Goldstein, DVM, FAVD, Dipl AVDC
Associate Medical Director - Veterinary Medical Center
Section Chief of Dentistry and Oral Surgery
Veterinary Clinical Sciences
College of Veterinary Medicine, University of Minnesota
1352 Boyd Ave., St. Paul, MN 55108
Office: 612-625-1781, Fax: 612-624-0751
email: gold034@umn.edu
http://www.cvm.umn.edu/vmc/Veterinary_Dental_Education_Center.html*



Barden A. Greenfield, DVM

Dr. Barden Greenfield is a graduate of Mississippi State University College of Veterinary Medicine. His focus in practice is veterinary dentistry, and he has a referral dental practice at Southwind Animal Hospital in Memphis, TN. He is presently enrolled in the Alternate Pathways Program of the American Veterinary Dental College (AVDC). He is also on the Board of Directors of the American Veterinary Dental Society (AVDS). Dr. Greenfield enjoys teaching veterinary dentistry throughout the country and is a passionate advocate of thorough and comprehensive oral care for small animals.

*Barden A. Greenfield, DVM
Mid South Veterinary Dental Referrals
901-624-9002*

*Board of Directors
American Veterinary Dental Society (AVDS)
Website: www.avds.org*



Barron P. Hall, DVM

*Diplomate, American Veterinary Dental College
Fellow, Academy of Veterinary Dentistry*

Dr. Barron P. Hall graduated from The Ohio State University College of Veterinary Medicine in 1993. After practicing veterinary medicine with a special interest in dentistry and oral surgery, he began a veterinary dental and oral surgical residency in Dallas, Texas under the guidance of Robert Wiggs, DVM, FAVD, Dipl., AVDC. Following his residency, he opened a veterinary dental practice in Northern Kentucky where he practiced for three years before accepting the opportunity to become a partner at the Animal Dental Clinic in 2006.

Dr. Hall is a Diplomate of the American Veterinary Dental College, of which there are only 105 in the world, and a Fellow of the Academy of Veterinary Dentistry. He continues his training by attending numerous professional meetings and hands-on laboratories. He has also given or assisted in more than 100 lectures and laboratory workshops for veterinarians, technicians, and pet owners both nationally and internationally on various topics in veterinary dentistry. He is a consultant for the Veterinary Information Network (VIN) and the veterinary dentist for the National Zoo in Washington, D.C.

*Animal Dental Clinic
410 Maple Ave West, Suite 1
Vienna, VA 22180
(703)281-5900
www.adcva.com*

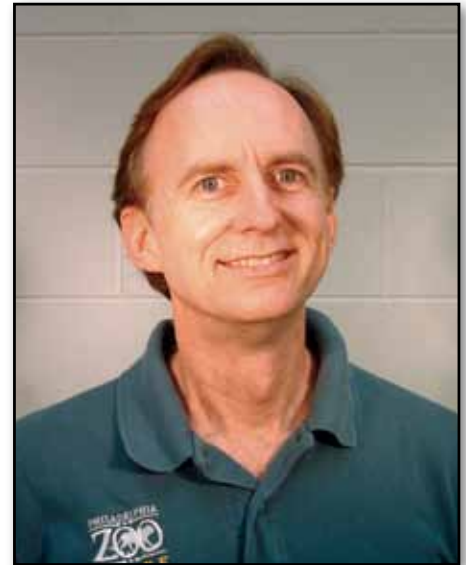

Keith C. Hinshaw, DVM, MPVM,

Dr. Hinshaw is a 1980 graduate of the University of California at Davis, where he was senior class president and co-valedictorian. During veterinary school he selected the non-domestic animal track, which emphasized clinical experience in zoo, exotic pet, and laboratory animal medicine. During his last year of veterinary school, he also enrolled in the Master of Preventive Veterinary Medicine (MPVM) program at UCD, which he completed in 1981. The MPVM program provides advanced training in epidemiology, biostatistics, and medical data management to prepare veterinarians to investigate disease problems in animal populations.

After graduating from veterinary school, Dr. Hinshaw entered the Primate Medicine residency program at the California National Primate Research Center located on the edge of the UC Davis campus. In addition to providing medical care for the primates and other animals at the Center, he also gained more experience through rotations in the residency programs in UCD's Non-domestic Animal Medicine service and Laboratory Animal Medicine service. He completed the Primate Medicine residency in 1982 and was then hired as Director of Animal Health at the Philadelphia Zoo.

Since 1982, Dr. Hinshaw has overseen the animal health program at the Philadelphia Zoo. In addition to providing veterinary care for the Zoo's animal collection, he supervises the veterinary staff, which includes a second clinical veterinarian, 3 veterinary technicians, and a veterinary pathologist. The Philadelphia Zoo also offers a 2 year post-graduate training program in zoological medicine and surgery, as well as externship opportunities to fourth year veterinary students interested in zoo medicine. Dr. Hinshaw also has an adjunct appointment at the nearby University of Pennsylvania School of Veterinary Medicine, where he has provided lectures on zoological medicine.



Steven E. Holmstrom, DVM, DAVDC
Diplomate, American Veterinary Dental College

Steven E. Holmstrom, DVM, Dipl. AVDC, currently practices at the Animal Dental Clinic in San Carlos, California, having been certified by the American Veterinary Dental College (AVDC) 1989. Dr. Holmstrom earned his DVM degree from the University of Missouri in 1972.

Dr. Holmstrom has consulted for the National Aeronautics and Space Administration Ames Research Center, University of California at Berkeley and Santa Cruz campuses, Moss Landing Marine Lab, Monterey Bay Aquarium and numerous pharmaceutical and dental companies. He is a Past President of the American Veterinary Dental College (AVDC), Academy of Veterinary Dentistry and American Veterinary Dental Society (AVDS). He is the current Treasurer of the AVDC. He has received awards including the AVDC Service Award, AVDS Education Award, AAHA Far West Practitioner of the Year and the University of Missouri College of Veterinary Medicine Alumnus of the Year. He has written numerous articles and publications, including a textbook on veterinary dental techniques, now in its third edition, and published in Japanese, Spanish and Italian; a textbook for veterinary technicians and is the Guest Editor for two editions of *Veterinary Clinics of North America*. He speaks frequently on veterinary dentistry at major national and international meetings.

For recreation he is an underwater SCUBA Instructor, Ham radio operator, motorhome enthusiast, and avid Sailor. He is a past Commodore of the Sequoia Yacht Club in Redwood City. He also donates his time to the Rotary Club of San Carlos and Peter Emily International Veterinary Dental Foundation.

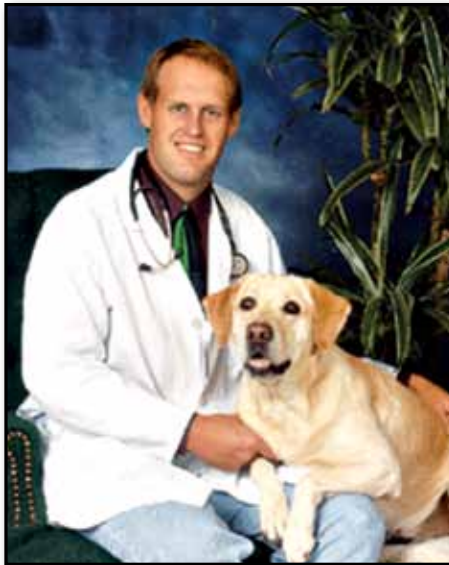

Brook Niemiec, DVM, DAVDC
Diplomate, American Veterinary Dental College
Fellow, Academy of Veterinary Dentistry

Dr. Brook Niemiec is a 1994 graduate of the University of California, Davis School of Veterinary Medicine, and a Board Certified specialist in Veterinary Dentistry as well as a Fellow in the Academy of Veterinary Dentistry.

As one of only 100 Board Certified Veterinary Dental specialists worldwide, Dr. Niemiec is recognized internationally as one of the leading authorities in Veterinary Dentistry.

Dr. Niemiec is the Chief of Staff of Southern California Veterinary Dental Specialties and has been serving the dental needs of animals (pets and zoo animals) for over a decade. During this time, he has performed over 30,000 dental procedures, including endodontic therapy (root canals and vital pulp therapy), oral and maxillofacial surgery, periodontal therapy and surgery, orthodontics (braces), restorative and cosmetic dentistry, and prosthetic (crowns and bridges) dentistry.

As an innovator in veterinary dentistry, Dr. Niemiec has brought several advancements to the field. His contributions include: the introduction of ultrasonic debridement for surgical endodontic procedures, stainless steel carriers for veterinary patients, bridges, and implantology.

An advocate for improved understanding, prevention and treatment of disease, Dr. Niemiec enjoys teaching, and lectures extensively to professional and non-professional groups at local, national, and international meetings. Additionally, he has published numerous articles in veterinary medical journals at the local, state, national, and international levels.

In the continued interest of teaching, Dr. Niemiec is the cofounder of a veterinary dental radiology telemedicine and training website, www.vetdentalrad.com, and has also recently added an international training center in San Diego, CA. For information on classes, please visit www.vetdentaltraining.com.

In his spare time, Dr. Niemiec is an enthusiastic outdoorsman who enjoys hiking, fishing, skiing, camping and playing golf, as well as visiting museums, attending live theater, and sporting events. He also enjoys frequent trips to the beach with his Labrador Retriever, Caeli, and returns home to his black cat Nez. For more information on Dr. Niemiec, or veterinary dentistry, please visit his website www.dogbeachdentistry.com or call Southern California Veterinary Dental Specialties at (858) 279-2108.

San Diego Veterinary Dental Training Center

*Expert guidance provided by Brook Niemiec,
DVM Diplomate, American Veterinary Dental College.*

*Class and seminar information at
www.vetdentaltraining.com or call (858) 279-2108*



Laura Putnam, DVM

Dr. Putnam graduated from the University of California, Davis School of Veterinary Medicine in 2005. After completion of a one year private practice internship at PetCare in Santa Rosa, California, she moved back to her hometown of Santa Barbara where she currently practices small animal medicine.

At work, Dr. Putnam has a special interest in emergency, soft tissue surgery and getting to know her clients. She lives with her husband, their two dogs and three cats. In her spare time she can be found exploring the foothills, mountains and beaches of Santa Barbara with her furry family.

Carpinteria Veterinary Hospital, California



Katherine E. Queck, DVM

Fellow, Academy of Veterinary Dentistry

Dr. Queck opened The Carolinas Animal Hospital and Dental Clinic in 1993. A graduate of Iowa State University, Dr. Queck has performed advanced dental procedures on pets for over 20 years. She is a Fellow of the Academy of Veterinary Dentistry of which there are less than 100 members worldwide. She has published scientific papers, conducts teaching laboratories, and provides continuing education seminars for veterinary staff. She firmly believes comprehensive dental care for pets helps them live longer and happier lives.

The Carolinas Animal Hospital & Dental Clinic P.A.
13331 York Center Drive, Suite A
Charlotte, NC 28273
704-588-9788
www.carolinasanimalhospital.com



Billy Scott, DVM

Dr. Scott received his Bachelor of Science from Mississippi State in 1988, and received his Doctorate of Veterinary Medicine from Mississippi State College of Veterinary Medicine in 1992. He has practiced small animal medicine since 1992 in Clarksville, AR. Dr. Scott is currently enrolled in American Veterinary Dental College Alternate Pathway Training Program and tracking for the Academy of Veterinary Dentistry, member of American Veterinary Medical Association, Arkansas Veterinary Medical Association, American Veterinary Dental Society and Rotary International. He currently operates a veterinary dental referral practice, Advanced Veterinary Dental Care, in Arkansas.

Advanced Veterinary Dental Care
1408 East Main Street, Clarksville, AR 72830
479-754-7387 (W)



Sara L. Sharp, CVT VTS (Dentistry)

Secretary, Academy of Veterinary Dental Technicians

Sara Sharp is a Veterinary Technician Specialist in Dentistry and has been teaching in the Colorado area for the past 10 years and working in conjunction with Pfizer Animal Health. She is a credentialed veterinary technician who holds a specialty status in dentistry through the National Association of Veterinary Technicians in America/ CVTS approved Academy of Veterinary Dental Technicians. She has lectured and taught wet labs nationwide with AAHA, AVMA and the Annual Veterinary Dental Forum. Sara has published many articles in assorted journals. She has worked doing almost exclusively dentistry for the past 22 years in the Denver area.



Mark Sopko, ASVDT

Mark Sopko is an ASVDT Certified Veterinary Dental Technician and the owner of SOPKO VETERINARY DENTAL SERVICES, LLC. Understanding the need for veterinary dental training, Mark established his company in 2000 and consults for private practice veterinary clinics where his topics include proper dental techniques, instrumentation, client communication, and dental radiography. He has been working in the Veterinary Dental field since 1995.

Mark has worked as a curator and animal handler at a local zoo. He also worked as a wildlife rehabilitator for the state of New Jersey, and began his career in animal medicine as a veterinary technician where he discovered his passion for veterinary dentistry. Over the years Mark has conducted numerous educational training programs for Universities & Technical Programs, nature centers, veterinary conferences, and related organizations on various animal health topics.

Sopko Veterinary Dental Services, LLC
(908) 698-7260

E-mail: mark@sopkopetdental.com

Website: <http://www.sopkopetdental.com>



Kevin Stepaniuk, DVM, DAVDC

*Diplomate, American Veterinary Dental College
Fellow, Academy of Veterinary Dentistry
Pacific Veterinary Dental Services P.S.*

Dr. Stepaniuk completed his undergraduate degree at the University of Calgary and his Doctor of Veterinary Medicine degree at Oklahoma State University. He completed a small animal medicine and surgery internship at Washington State University before entering into private practice. Dr. Stepaniuk practiced in a general and emergency veterinary medicine prior to focusing on veterinary dentistry and oral surgery. He is a Fellow of the Academy of Veterinary Dentistry and a Diplomate of the American Veterinary Dental College. Dr. Stepaniuk owns and operates a referral veterinary dentistry and oral surgery practice. Currently, he is a director for the American Veterinary Dental Society. He has internationally lectured and taught wet labs in veterinary dentistry and oral surgery.

Pacific Veterinary Dental Services P.S.

PO BOX 3347

Silverdale, WA 98383

kevindentvdm@earthlink.net



Carol Weldin, RDH, BS

Carol Weldin, RDH, BS, is a Registered Dental Hygienist who has been involved in veterinary dentistry since 1981 working with one of the charter members of the American Veterinary Dental College on the design of specialty instruments and proper prophylaxis techniques for companion animals.

Carol was a reviewer of *Veterinary Dental Techniques*, 1st and 2nd editions, published by W.B. Saunders; also *Veterinary Dentistry for the Technician & Office Staff*, and has authored articles on veterinary dentistry to the dental hygiene community, along with designing specialty kits for veterinary dentistry instrumentation, most notably the Weldin Periodontal Instrument Kit. She has chaired periodontal instrumentation courses at the Annual Veterinary Dentistry Forum, is an officer of the American Veterinary Dental Society, a Trustee of the Foundation For Veterinary Dentistry, and is currently involved with the American Veterinary Dental Technicians as a member of the Advisory Committee, and has been appointed to the Organizing Committee for the Center for Animals in Society, University of California Davis School of Veterinary Medicine.

Carol has lectured nationally on Advances in Veterinary Dentistry, with particular emphasis on the use of high-frequency ultrasonic instrumentation, along with instrument selection, care and usage. She is currently involved in additional new product development for veterinary dentistry.

Carol is an affiliate member of the following two organizations: Association of Human-Animal Bond Veterinarians and the International Association of Assistance Dog Partners. In addition, she is a member of the American Association of University Women.

She and her dog Trevin, a career change Canine Companions for Independence dog, are a certified pet therapy team, visiting hospitals, a pediatric hospice home, participating in a Paws To Read Literacy Program and various outreach programs that aim to increase awareness of the importance of animal-assisted therapy and the human-animal bond. They have been featured in numerous newspaper articles and a television interview.

carol.weldin@comcast.net • 925-937-9515



Robert "Bob" Bruce Wiggs, DVM, DAVDC

*Diplomate, American Veterinary Dental College
Adjunct Associate Professor at the Texas A&M
University System's Baylor College of Dentistry,
Dallas, Texas*

Dr. Robert B. Wiggs graduated from Texas A & M Commerce in 1970 with a B.S in Agriculture and Education. In 1972 he completed his B.S in Veterinary Science at Texas A & M University College Station, and his D.V.M in 1973. He owns the Dallas Dental Service Animal Clinic, and is an Adjunct Professor at the Texas A&M University System's Baylor College of Dentistry. He is a member and Past President of the Dallas County Veterinary Medical Association and a member and Past President of the American Veterinary Dental Society. He is also Past President and Charter Fellow of the Academy of Veterinary Dentistry, Past President and Diplomate of the American Veterinary Dental College, Past President and member of the Veterinary Oversight Group, and President of the World Veterinary Dental Counsel. He is author of *Veterinary Dentistry Principles and Practice* published by Lippincott Raven, a co-author of *The Veterinarian's Companion for Common Dental Procedures* and written over thirty chapters for other books and a large number of articles on veterinary dentistry. *Veterinary Dentistry Principles and Practice* was described as "The Bible of Veterinary Dentistry" in its reviews upon publication. Dr. Wiggs received the American Veterinary Dental College's Peter Emily Award in 1994, Texas A&M University's Outstanding Alumnus – Companion Animal Medicine Award in 1995, The Texas Veterinary Medical Association's Companion Animal Practitioner of the Year Award 1996, the American Veterinary Dental Society's Research and Education Award in 1999, The Academy of Dentistry's Fellow of the Year Award 2001, the Hu-Friedy Golden Scaler Award 2001 and others. Dr. Wiggs was lectured both nationally and internationally for many years.



Matt Wilson, DVM

Dr. Matt Wilson is a 1998 graduate of The Ohio State University College of Veterinary Medicine. He is a partner and business manager of Animal Clinic Northview Inc., a 16 doctor practice in North Ridgeville, Ohio. He has limited his practice to veterinary dentistry since 2000. He is currently enrolled in the Alternate Pathway program of the American Veterinary Dental College.

*Animal Clinic Northview
36400 Center Ridge Road
North Ridgeville, OH 44039
Ph: 440.327.8282 Fax: 440.353.0331
Emergencies: 440.452.7743*



Tony M. Woodward, DVM, DAVDC

Diplomate, American Veterinary Dental College

Dr. Woodward has been involved in veterinary practice for over 27 years. During that time he has owned several successful practices, ranging from equine/ small animal to dental specialty practice. He is board certified in veterinary dentistry by the American Veterinary Dental College, and is currently involved in dental referral practice. He is a frequent national lecturer on veterinary dentistry, and teaches over 30 wet labs a year at his dental training facility in Colorado (www.vetdentalclasses.com). Dr. Woodward is a past-president of the Colorado Veterinary Medical Association and a member of the Morris Animal Foundation's Veterinary Honor Roll.

*Animal Dental Care
5520 N. Nevada Ave. Ste. 150
Colorado Springs, CO 80918
(719) 536-9949*



THANK YOU!

Miltex expresses our sincere appreciation for contributing your valuable time, including providing us with your comments, clinical photography, product evaluations and sound clinical advice for the continuing advancement of Animal Health Medicine.

MILTEX® ANIMAL HEALTH INSTRUMENTS



TABLE OF CONTENTS

Scissors	1
Forceps	52
Needle Holders.....	104
Suturing.....	127
Retractors	136
Hooks	152
Rasps.....	158
Dilators	165
Trocars.....	172
Diagnostics.....	174
Anesthesia Instruments.....	182
Suction & Aspiration Instruments.....	184
Teat Instruments	190
Nail & Hoof Instruments	192
Syringes.....	195
General Dentistry Instruments	198
Prophylaxis Instruments	233
Oral Surgery Instruments.....	256
Endodontic Instruments.....	295
Ear Instruments	319
Electrosurgery Instruments.....	329
Surgical & Dental Kits	333
Microsurgical Instruments	343
Gynecological & Obstetrical Instruments	356
Ophthalmic Instruments	361
Orthopedic Instruments.....	374
Post Mortem Instruments	419
Spay, Neuter & Castration Instruments	422
Meisterhand™ Brand Instruments	426
Vantage® Brand Instruments.....	488
Disposable Products.....	497
Instrument Maintenance & Care Products.....	503
Stainless Steelware Products.....	529
Reference Guides.....	533
Alphabetical Index	545
Numerical Index.....	554

TRADEMARKS

Miltex, Inc., a subsidiary of Integra LifeSciences Corporation, has registered the following trademarks with the United States Patent and Trademark Office:

Carb-N-Sert®	Liberator®
Ceram-A-Grip®	Meisterhand®
Denlite®	Miltex®
Flex-R®	Mor-Flex®
Grip Lite®	Onyx-R®
Hi-5®	Sharpie®
Indian Head®	Union Broach®
Inject-R Fill®	Vantage®

Miltex, Inc., a subsidiary of Integra LifeSciences Corporation, is the owner of the following trademarks:

Articodent™	Silitone™
Endodilator™	Slide™
Endo-Gripper™	Sparta™
Endo-Klean™	Sprint™
Grip Deep™	Tactile Tone™
GTX™	Tardie™
Miltex Biopblade™	Thompson™
Miltex Redefining Excellence™	Tip-It™
Onyx-Flex™	Tri-R Post System™
Onyx-H™	Tuck-Away™
Precision™	

Integra LifeSciences Corporation has registered the following trademark with the United States Patent and Trademark Office:

Padgett Instruments®

Integra LifeSciences Corporation is the owner of the following trademarks:

Integra wave logo™
HeliTape™
HeliCote™
HeliPlug™

Any other trademarks and registered trademarks identified in this catalog are the property of their respective owners. The absence of a product or service name or logo from this listing does not constitute a waiver of Integra LifeSciences Corporation's trademark or other intellectual property rights concerning that name or logo.

MILTEX® SCISSORS

Premium Scissors, Tungsten Carbide & SuperCut ..	2-17
Operating Scissors.....	4
Iris and Tenotomy Scissors	5
Mayo Scissors	6-7
Metzenbaum Scissors.....	8-10
Miscellaneous Scissors	11
Gorney Scissors.....	12-13
Kaye Scissors.....	14-15
Specialty Scissors	16-17
General Surgery Scissors	18-51
Operating Scissors.....	18-19
Operating & Dissecting Scissors	20-27
Mayo Scissors	21
Metzenbaum Scissors.....	22
Plastic Surgery Scissors	28
General Surgery Scissors.....	29-33
Suture Scissors	34
Stitch and Wire Scissors	35-37
Iris Scissors.....	38
Eye Scissors	39-41
Microsurgery Scissors	42-44
Specialty Scissors & Cutting Instruments	45
Alligator & Nasal Scissors.....	46
Bandage and Utility	47-49
Rib Shears	50
Cast Instruments	51



ANATOMY OF MILTEX® SCISSORS

Miltex crafts high quality, surgical grade stainless steel scissors designed to provide exceptional performance in a variety of applications.

The careful construction of all Miltex® scissors permits their use for multiple procedures.

- Cutting and dissecting tissue
- Cutting suture, dressing, tubing and a variety of other materials

Always use the scissors designed for a particular task to achieve the desired outcome.

A precise cutting action depends upon

- Carefully honed blades
- A proper amount of “play” between blades
- A well-balanced instrument

Dissection (or probing) depends upon

- A smooth finish to the outer edge of the blades
- Properly rounded tips that meet fully when closed

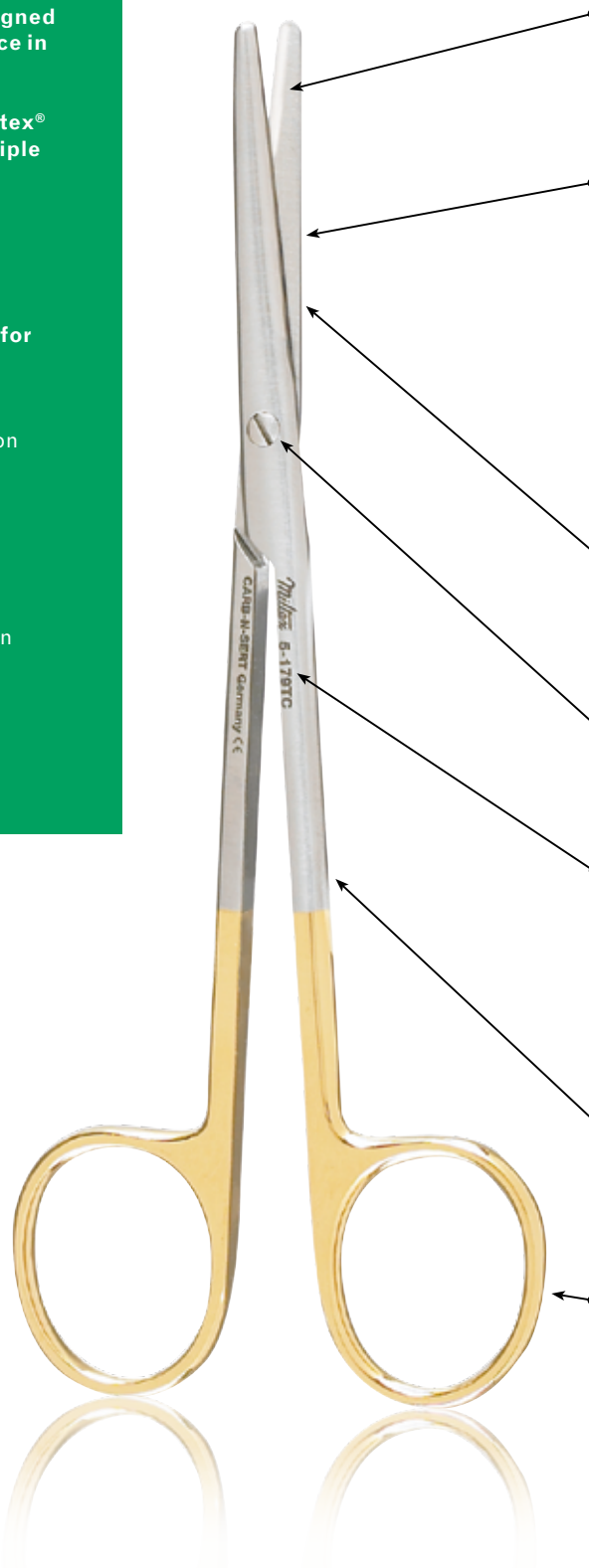

CHOICE OF BLADES

Carb-N-Sert® (Tungsten Carbide)
SuperCut
SuperCut/Carb-N-Sert® combination
Stainless Steel

BLADE DESIGN

Tungsten carbide inserts are seamlessly bonded to the finest quality stainless steel surgical scissors then precisely ground and honed on diamond wheels.

SuperCut Scissors have a finely beveled blade with a razor-sharp edge and opposing blade with micro-fine serrations to prevent tissue slippage and to facilitate effortless cutting.

STRENGTH & HARDNESS

Manufactured to ensure greater Rockwell hardness for instrument durability and longer-lasting blade edge sharpness.

SCREW LOCK

Fully tempered precision screw locks maintain perfect alignment.

LASER ETCHING

All Miltex® Scissors are laser etched with our logo and catalog number for easy re-ordering. Advanced laser techniques no longer harm instruments the way traditional acid etching techniques did.

ERGONOMIC DESIGN

Outstanding instrument design combines weight, balance and feel for optimal comfort and performance.

RING HANDLES

Well rounded and polished for better feel and comfort as well as for prevention of hand fatigue. Gold and black finished handles differentiate tungsten carbide and SuperCut Scissors as precision instruments.

MILTEX® SUPERCUT SCISSORS

SuperCut Scissors have a specially designed razor-sharp upper blade edge that cuts effortlessly through tissue. The lower blade has micro-fine serrations to hold tissue and to prevent slippage. For easy identification, Miltex® SuperCut Scissors have black ring handles.

SuperCut Scissors are designed to cut tissue only. Dropping or mishandling the scissors will cause the razor-sharp edge to nick or to become irregular. Proper handling will ensure lifetime service. Resharpening at regular intervals is recommended and is a service that Miltex offers.

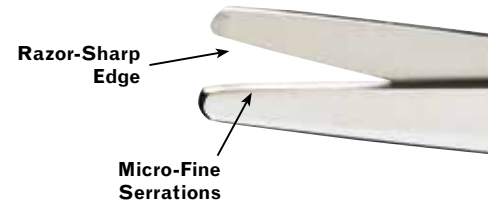

MILTEX® CARB-N-SERT® SCISSORS*

Carb-N-Sert® Scissors have tungsten carbide inserts seamlessly bonded to the upper and lower blades. These premium-grade scissors offer precision cutting performance as well as the durability of tungsten carbide cutting edges.

Carb-N-Sert® Scissors provide consistently superior performance and extended service life, resulting in considerable cost savings to the clinician.

Miltex® Carb-N-Sert® Scissors are easily identified by the gold ring handles.

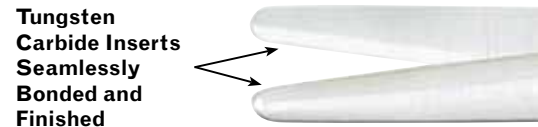

SUPERCUT/CARB-N-SERT® SCISSORS*

The combination SuperCut/Carb-N-Sert® Scissors by Miltex offer precision SuperCut performance with one lower serrated blade and one upper razor-sharp blade combined with the durability of tungsten carbide cutting edges.

SuperCut/Carb-N-Sert® Scissors are easily identified with one short and one long gold-plated ring handle.

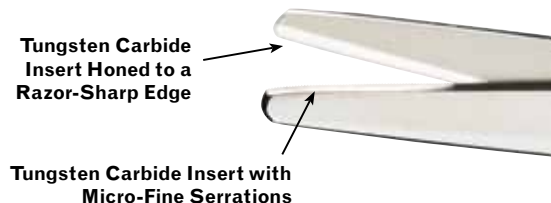

* Note: cold or chemical sterilization is not recommended for tungsten carbide instruments.

Operating Scissors

General utility scissors with sharp-blunt and blunt-blunt tips are ideal for cutting suture, gauze, tubing and other materials. The sharp-sharp patterns are also used for general utility applications but are preferred for cutting tendons and cartilage. **Note: SuperCut scissors are not recommended for use on suture, gauze or tubing.**

REF	Description	Tip	Type	Length
5-6TC	Operating Scissors	straight, sharp/sharp	Carb-N-Sert	5-1/2" (14 cm)
5-16TC	Operating Scissors	straight, sharp/blunt	Carb-N-Sert	5-1/2" (14 cm)
5-SC-16	Operating Scissors	straight, sharp/blunt	SuperCut	5-1/2" (14 cm)
5-26TC	Operating Scissors	straight, blunt/blunt	Carb-N-Sert	5-1/2" (14 cm)
5-36TC	Operating Scissors	curved, sharp/sharp	Carb-N-Sert	5-1/2" (14 cm)
5-46TC	Operating Scissors	curved, sharp/blunt	Carb-N-Sert	5-1/2" (14 cm)
5-SC-46	Operating Scissors	curved, sharp/blunt	SuperCut	5-1/2" (14 cm)
5-56TC	Operating Scissors	curved, blunt/blunt	Carb-N-Sert	5-1/2" (14 cm)



Iris Scissors

Popular sharp/sharp scissors offer outstanding distal cutting capability of tissue and suture. **Note: SuperCut scissors are not recommended for use on suture material.**

REF	Description	Tip	Type	Length
5-304TC	Iris Scissors	straight, sharp	Carb-N-Sert	4-1/2" (11.4 cm)
5-SC-304	Iris Scissors	straight, sharp	SuperCut	4-1/2" (11.4 cm)
5-SC-304TC	Iris Scissors	straight, sharp	combination SuperCut/Carb-N-Sert	4-1/2" (11.4 cm)
5-306TC	Iris Scissors	curved, sharp	Carb-N-Sert	4-1/2" (11.4 cm)
5-SC-306	Iris Scissors	curved, sharp	SuperCut	4-1/2" (11.4 cm)
5-SC-306TC	Iris Scissors	curved, sharp	combination SuperCut/Carb-N-Sert	4-1/2" (11.4 cm)



STEVENS Tenotomy Scissors

The delicate blade design tapers for fine tissue penetration and dissection. Tenotomy scissors are excellent for general, ophthalmic, dermatological and dental procedures.

REF	Description	Tip	Type	Length
18-SC-1470	STEVENS Tenotomy Scissors	straight, sharp	SuperCut	4-1/2" (11.4 cm)
18-SC-1472	STEVENS Tenotomy Scissors	straight, blunt	SuperCut	4-1/2" (11.4 cm)
18-SC-1474	STEVENS Tenotomy Scissors	curved, sharp	SuperCut	4-1/2" (11.4 cm)
18-SC-1476	STEVENS Tenotomy Scissors	curved, blunt	SuperCut	4-1/2" (11.4 cm)



MAYO Scissors (with standard beveled blades)

Sturdy, durable and reliable scissors. The robust and heavier design is used to precisely cut and dissect tough, thick and muscular tissue.

REF	Description	Tip	Type	Length
5-SC-120	MAYO Scissors	straight, blunt	SuperCut	5-1/2" (14 cm)
5-120TC	MAYO Scissors	straight, blunt	Carb-N-Sert	5-1/2" (14 cm)
5-SC-122	MAYO Scissors	curved, blunt	SuperCut	5-1/2" (14 cm)
5-122TC	MAYO Scissors	curved, blunt	Carb-N-Sert	5-1/2" (14 cm)
5-SC-124	MAYO Scissors	straight, blunt	SuperCut	6-3/4" (17.1 cm)
5-124TC	MAYO Scissors	straight, blunt	Carb-N-Sert	6-3/4" (17.1 cm)
5-SC-126	MAYO Scissors	curved, blunt	SuperCut	6-3/4" (17.1 cm)
5-126TC	MAYO Scissors	curved, blunt	Carb-N-Sert	6-3/4" (17.1 cm)
5-SC-128	MAYO Scissors	straight, blunt	SuperCut	9" (22.9 cm)
5-128TC	MAYO Scissors	straight, blunt	Carb-N-Sert	9" (22.9 cm)
5-SC-130	MAYO Scissors	curved, blunt	SuperCut	9" (22.9 cm)
5-130TC	MAYO Scissors	curved, blunt	Carb-N-Sert	9" (22.9 cm)



5-SC-122
5-SC-126
5-SC-130

5-SC-120
5-SC-124
5-SC-128



5-122TC
5-126TC
5-130TC

5-120TC
5-124TC
5-128TC

MAYO Scissors (with rounded blades)

Reinforced rounded blades provide additional strength and durability when used to cut or dissect the very toughest tissue.

REF	Description	Tip	Type	Length
5-136TC	MAYO Scissors	straight, blunt	Carb-N-Sert	5-1/2" (14 cm)
5-138TC	MAYO Scissors	curved, blunt	Carb-N-Sert	5-1/2" (14 cm)
5-140TC	MAYO Scissors	straight, blunt	Carb-N-Sert	6-3/4" (17.1 cm)
5-142TC	MAYO Scissors	curved, blunt	Carb-N-Sert	6-3/4" (17.1 cm)



5-136TC
5-140TC



5-138TC
5-142TC

METZENBAUM Scissors (standard pattern with blunt tips)

This very popular and versatile pattern features gently rounded tips for dissection. A light and perfectly balanced design precisely cuts either tough or delicate tissue.

REF	Description	Tip	Type	Length
5-179TC	METZENBAUM (LAHEY) Scissors	straight, blunt	Carb-N-Sert	5-1/2" (14 cm)
5-SC-179	METZENBAUM (LAHEY) Scissors	straight, blunt	SuperCut	5-1/2" (14 cm)
5-180TC	METZENBAUM (LAHEY) Scissors	curved, blunt	Carb-N-Sert	5-1/2" (14 cm)
5-SC-180	METZENBAUM (LAHEY) Scissors	curved, blunt	SuperCut	5-1/2" (14 cm)
5-SC-283	METZENBAUM Scissors	straight, blunt	SuperCut	4-1/2" (11.4 cm)
5-SC-284	METZENBAUM Scissors	curved, blunt	SuperCut	4-1/2" (11.4 cm)



5-179TC



5-180TC



5-SC-179



5-SC-180



5-SC-283



5-SC-284

METZENBAUM Scissors (standard pattern with blunt tips), continued

Choose from six lengths to accommodate deep cavity surgical needs.

REF	Description	Tip	Type	Length
5-181TC	METZENBAUM Scissors	straight, blunt	Carb-N-Sert	7" (17.8 cm)
5-182TC	METZENBAUM Scissors	curved, blunt	Carb-N-Sert	7" (17.8 cm)
5-SC-182	METZENBAUM Scissors	curved, blunt	SuperCut	7" (17.8 cm)
5-SC-182TC	METZENBAUM Scissors	curved, blunt	Combination SuperCut/Carb-N-Sert	7" (17.8 cm)
5-184TC	METZENBAUM Scissors	curved, blunt	Carb-N-Sert	8" (20.3 cm)
5-186TC	METZENBAUM Scissors	straight, blunt	Carb-N-Sert	9" (22.9 cm)
5-188TC	METZENBAUM Scissors	curved, blunt	Carb-N-Sert	9" (22.9 cm)
5-SC-188	METZENBAUM Scissors	curved, blunt	SuperCut	9" (22.9 cm)
5-189A-TC	METZENBAUM Scissors	curved, blunt	Carb-N-Sert	10" (25.4 cm)
5-192TC	METZENBAUM Scissors	curved, blunt	Carb-N-Sert	11" (27.9 cm)
5-193A-TC	METZENBAUM Scissors	curved, blunt	Carb-N-Sert	12" (30.5 cm)

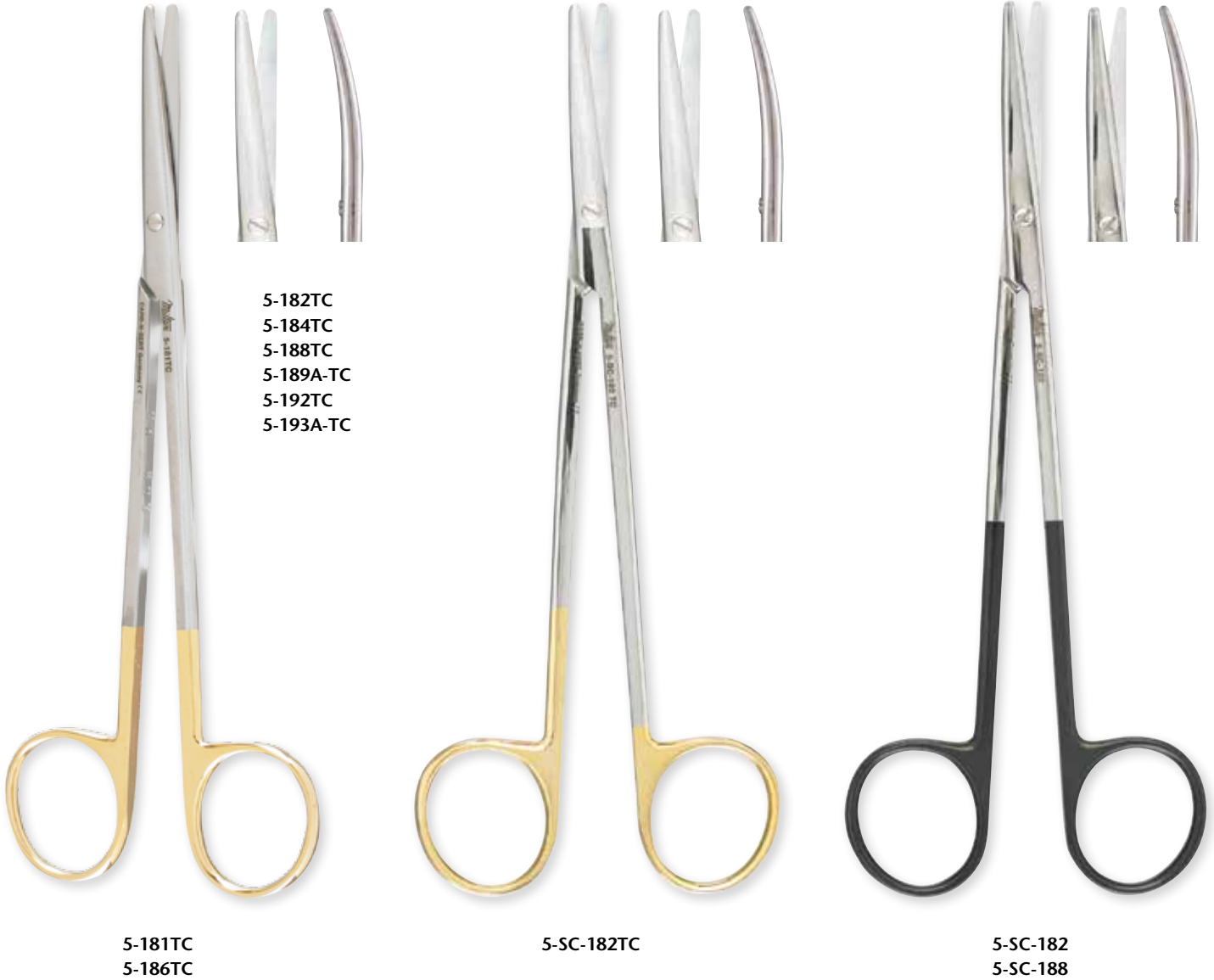

METZENBAUM Scissors (delicate pattern with blunt & sharp tip options)

These scissors feature a light and delicate blade design with blunt or sharp tip options.

REF	Description	Tip	Type	Length
5-179A-TC	METZENBAUM Scissors	straight, delicate, blunt	Carb-N-Sert	5-1/2" (14 cm)
5-179B-TC	METZENBAUM Scissors	straight, delicate, sharp	Carb-N-Sert	5-1/2" (14 cm)
5-180A-TC	METZENBAUM Scissors	curved, delicate, blunt	Carb-N-Sert	5-1/2" (14 cm)
5-180B-TC	METZENBAUM Scissors	curved, delicate, sharp	Carb-N-Sert	5-1/2" (14 cm)
5-181A-TC	METZENBAUM Scissors	straight, delicate, blunt	Carb-N-Sert	7" (17.8 cm)
5-181B-TC	METZENBAUM Scissors	straight, delicate, sharp	Carb-N-Sert	7" (17.8 cm)
5-182A-TC	METZENBAUM Scissors	curved, delicate, blunt	Carb-N-Sert	7" (17.8 cm)
5-182B-TC	METZENBAUM Scissors	curved, delicate, sharp	Carb-N-Sert	7" (17.8 cm)
5-187TC	METZENBAUM Scissors	straight, delicate, blunt	Carb-N-Sert	9" (22.9 cm)
5-189TC	METZENBAUM Scissors	curved, blunt	Carb-N-Sert	9" (22.9 cm)
PM-6810*	METZENBAUM Scissors	curved, blunt	SuperCut	5-3/4" (14.6 cm)
PM-6811*	METZENBAUM Scissors	curved, blunt	SuperCut	7" (17.8 cm)
PM-6812*	METZENBAUM Scissors	curved, blunt	SuperCut	9" (22.9 cm)
PM-6813*	METZENBAUM Scissors	curved, delicate, blunt	SuperCut	7" (17.8 cm)



5-179A-TC
5-181A-TC
5-187-TC



5-180A-TC
5-182A-TC
5-189-TC



5-179B-TC
5-181B-TC
5-189-TC



5-180B-TC
5-182B-TC
5-187TC



PM-6810
PM-6811
PM-6812
PM-6813

Miscellaneous General & Specialty Scissors

STRABISMUS Scissors

This pattern is a smaller and more delicate version of a "Baby Metzenbaum". Rounded tips are useful for small delicate surgical dissection.

GOLDMAN-FOX Scissors

A longer and slightly heavier version of the Tenotomy scissors; one-serrated blade for optimum tissue grip is ideal for wound debridement and other precise dissection of delicate tissue.

PLASTIC SURGERY Scissors

General purpose plastic surgery scissors are a longer and slightly heavier version of the "Iris Scissors".

RAGNELL Scissors

The blunt and flattened tip design is ideal for controlled undermining and precise tissue dissection.

GRADLE Scissors

This is a very popular pattern for dermatology and ophthalmology applications. The delicate "Tenotomy-like" tips are ideal for delicate dissection.

REF	Description	Tip	Type	Length
5-312TC	STRABISMUS Scissors	straight, blunt	Carb-N-Sert	4-1/2" (11.4 cm)
5-314TC	STRABISMUS Scissors	curved, blunt	Carb-N-Sert	4-1/2" (11.4 cm)
5-320TC	GOLDMAN-FOX Scissors	curved, blunt	Carb-N-Sert	5" (12.7 cm)
5-SC-320	GOLDMAN-FOX Scissors	curved, blunt	SuperCut	5" (12.7 cm)
5-SC-270	PLASTIC SURGERY Scissors	straight, sharp	SuperCut	4-3/4" (12.1 cm)
5-SC-276	PLASTIC SURGERY Scissors	curved, sharp	SuperCut	4-3/4" (12.1 cm)
5-SC-290	RAGNELL (KILNER) Scissors	curved, blunt	SuperCut	5" (12.7 cm)
18-SC-1652	GRADLE Scissors	curved, blunt	Supercut	3-3/4" (9.5 cm)



GORNEY Scissors

The Gorney and Gorney-Freeman scissors are a heavier pattern when compared to the Kaye and Kaye-Freeman scissors and are ideal for general surgery procedures. Combined with the flattened tip, the saber-back blades with semi-sharp outer edges allow for effortlessly passing through and undermining tissue. The flattened and delicate blunt tips facilitate precise dissection.

REF	Description	Tip	Type	Length
21-SC-607	Gorney Rhytidectomy Scissors	straight	SuperCut	7-1/2" (19 cm)
21-SC-608	Gorney Rhytidectomy Scissors	curved	SuperCut	7-1/2" (19 cm)
21-608TC	Gorney Rhytidectomy Scissors	curved	Carb-N-Sert	7-1/2" (19 cm)
* All above scissors have an added single-serrated blade feature				
PM-6832**	Gorney Platysma Scissors	straight	SuperCut	9" (229 mm)
PM-6832TC**	Gorney Platysma Scissors	straight	Tungsten Carbide	9" (229 mm)
PM-6833**	Gorney Platysma Scissors	curved	SuperCut	9" (229 mm)
PM-6833TC**	Gorney Platysma Scissors	curved	Tungsten Carbide	9" (229 mm)

**  **PADGETT**
INSTRUMENTS By *Miltex*



21-SC-608



21-608TC



PM-6832
PM-6832TC

PM-6833
PM-6833TC

GORNEY-FREEMAN Scissors

The Gorney-Freeman pattern offers a slightly more defined flat-ended tip and angled-open shanks for optimum control and the reduction of hand fatigue.

REF	Description	Tip	Type	Length
21-SC-715	Gorney-Freeman Scissors	curved	SuperCut	7-1/4" (18.4 cm)
21-715TC	Gorney-Freeman Scissors	curved	Carb-N-Sert	7-1/4" (18.4 cm)
21-SC-716	Gorney-Freeman Scissors	straight	SuperCut	7-1/4" (18.4 cm)

* All above scissors have an added single-serrated blade feature



21-SC-716



21-SC-715



21-715TC

KAYE Scissors

The Kaye and Kaye-Freeman scissors are a lighter and more delicate option to the Gorney and Gorney-Freeman scissors patterns and are ideal for general surgery procedures. Combined with the flattened tip, the Saber-Back blades with semi-sharp outer edges allow for effortlessly passing through and undermining tissue. The flattened and delicate blunt tips facilitate precise dissection.

REF	Description	Tip	Type	Length
5-269TC	KAYE Blepharoplasty & Dissecting Scissors	curved	Carb-N-Sert	4-1/2" (11.4 cm)
21-740TC	KAYE Rhytidectomy & Dissecting Scissors	curved	Carb-N-Sert	5-3/4" (14.6 cm)
21-742TC	KAYE Rhytidectomy & Dissecting Scissors	curved	Carb-N-Sert	7" (17.8 cm)

* All above scissors have an added single-serrated blade feature



5-269TC



21-740TC
21-742TC

KAYE-FREEMAN Scissors

The Kaye-Freeman pattern has open angled shanks for optimum control and may afford reduced hand fatigue.

REF	Description	Tip	Type	Length
21-710TC	KAYE-FREEMAN Scissors	curved	Carb-N-Sert	7" (17.8 cm)
21-SC-710	KAYE-FREEMAN Scissors	curved	SuperCut	7" (17.8 cm)
21-SC-711	KAYE-FREEMAN Scissors	straight	SuperCut	7" (17.8 cm)

* All above scissors have an added single-serrated blade feature



21-710TC



21-SC-710

21-SC-711

Specialty Scissors

SUTURE/WIRE CUTTING Scissors
45° angled blades with rounded tips and wire notched blade make these scissors useful for cutting all types of suture and 26 AWG or smaller wire.

CONVERSE (WILMER) Scissors
Angled blades make these scissors ideal for dissection and for use as a general utility scissors.

MILTEX® Blepharoplasty Scissors
The lower serrated blade with flat tapered tip facilitates precise undermining of delicate tissue and is ideal for general, dermal and various surgical applications.

FOMON Saber-Back Scissors
The saber-back blade with semi-sharp outer edges and flattened tip help cut, dissect and undermine tissue in a variety of applications.

FOMON Dorsal Scissors
45° angled shanks provide optimum visibility during procedures. The strong narrow serrated blade design cuts cartilage effortlessly.

PAR Scissors
A lighter and more delicate variation to the Strabismus and Baby Metzenbaum scissors. A great pattern for precise dissecting and for cutting of delicate tissue.

REF	Description	Tip	Type	Length
9-124TC	Suture/Wire Cutting Scissors	45° angle, one serrated blade	Carb-N-Sert	4-3/4" (12.1 cm)
18-1440TC	CONVERSE (WILMER) Scissors	blades angled on flat, sharp tips	Carb-N-Sert	4-1/2" (11.4 cm)
21-537TC	MILTEX Blepharoplasty Scissors	curved flat tips, one serrated blade	Carb-N-Sert	4-1/2" (11.4 cm)
21-SC-600	FOMON Saber-Back Scissors	slightly curved blades with semi-sharp outer edges for dissection	SuperCut	5-1/4" (13.3 cm)
21-604TC	FOMON Dorsal Scissors	angled shanks	Carb-N-Sert	5-1/2" (14 cm)
21-SC-745	PAR Dissecting & Tissue Scissors	curved, delicate blades with blunt tip	SuperCut	4-1/2" (11.4 cm)



9-124TC



18-1440TC



21-537TC



21-SC-600



21-604TC



21-SC-745

Specialty Scissors

The Miltex® Z-Type Scissors have a precise form and bend to cut tissue. These scissors feature a robust design which offers lasting sharpness and durability.

REF	Description	Tip	Type	Length
30-2101TC	Z-Type Scissors	slight curve	Carb-N-Sert	9" (22.8 cm)
30-2102TC	Z-Type Scissors	curve	Carb-N-Sert	9" (22.8 cm)
30-2103TC	Z-Type Scissors	full curve	Carb-N-Sert	9" (22.8 cm)
30-2105TC	Z-Type Scissors	slight curve	Carb-N-Sert	10-1/2" (26.6 cm)
30-2106TC	Z-Type Scissors	curve	Carb-N-Sert	10-1/2" (26.6 cm)
30-2107TC	Z-Type Scissors	full curve	Carb-N-Sert	10-1/2" (26.6 cm)
30-2109TC	Z-Type Scissors	slight curve	Carb-N-Sert	12" (30.4 cm)
30-2110TC	Z-Type Scissors	curve	Carb-N-Sert	12" (30.4 cm)
30-2111TC	Z-Type Scissors	full curve	Carb-N-Sert	12" (30.4 cm)



30-2101TC



30-2101TC
30-2105TC
30-2109TC



30-2102TC
30-2106TC
30-2110TC



30-2103TC
30-2107TC
30-2111TC

Operating Scissors

REF	Description	Type	Tips	Length
5-2	Operating Scissors	straight	sharp/sharp	4-1/2" (11.4 cm)
5-4	Operating Scissors	straight	sharp/sharp	5" (12.7 cm)
5-6	Operating Scissors	straight	sharp/sharp	5-1/2" (14 cm)
5-7	Operating Scissors	straight	sharp/sharp	6" (15.2 cm)
5-8	Operating Scissors	straight	sharp/sharp	6-1/2" (16.5 cm)
<hr/>				
5-12	Operating Scissors	straight	sharp/blunt	4-1/2" (11.4 cm)
5-14	Operating Scissors	straight	sharp/blunt	5" (12.7 cm)
5-16	Operating Scissors	straight	sharp/blunt	5-1/2" (14 cm)
5-17	Operating Scissors	straight	sharp/blunt	6" (15.2 cm)
5-18	Operating Scissors	straight	sharp/blunt	6-1/2" (16.5 cm)
5-19	Operating Scissors	straight	sharp/blunt	7-1/2" (19.1 cm)
<hr/>				
5-22	Operating Scissors	straight	blunt/blunt	4-1/2" (11.4 cm)
5-24	Operating Scissors	straight	blunt/blunt	5" (12.7 cm)
5-26	Operating Scissors	straight	blunt/blunt	5-1/2" (14 cm)
5-27	Operating Scissors	straight	blunt/blunt	6" (15.2 cm)
5-28	Operating Scissors	straight	blunt/blunt	6-1/2" (16.5 cm)
<hr/>				
5-32	Operating Scissors	curved	sharp/sharp	4-1/2" (11.4 cm)
5-34	Operating Scissors	curved	sharp/sharp	5" (12.7 cm)
5-36	Operating Scissors	curved	sharp/sharp	5-1/2" (14 cm)
5-37	Operating Scissors	curved	sharp/sharp	6" (15.2 cm)
5-38	Operating Scissors	curved	sharp/sharp	6-1/2" (16.5 cm)
<hr/>				
5-42	Operating Scissors	curved	sharp/blunt	4-1/2" (11.4 cm)
5-44	Operating Scissors	curved	sharp/blunt	5" (12.7 cm)
5-46	Operating Scissors	curved	sharp/blunt	5-1/2" (14 cm)
5-48	Operating Scissors	curved	sharp/blunt	6-1/2" (16.5 cm)
5-49	Operating Scissors	curved	sharp/blunt	7-1/2" (19.1 cm)
<hr/>				
5-52	Operating Scissors	curved	blunt/blunt	4-1/2" (11.4 cm)
5-54	Operating Scissors	curved	blunt/blunt	5" (12.7 cm)
5-56	Operating Scissors	curved	blunt/blunt	5-1/2" (14 cm)
5-58	Operating Scissors	curved	blunt/blunt	6-1/2" (16.5 cm)



5-2 to
5-28

5-32 to
5-58



Sharp/Sharp

Sharp/Blunt

Blunt/Blunt



5-17

Operating Scissors

SERRATEX OPERATING SCISSORS

Standard pattern operating scissors featuring one blade with fine serrations to reduce tissue slippage.

DELICATE PATTERN LIGHTWEIGHT OPERATING SCISSORS

Delicate pattern operating scissors designed for pediatrics, vascular and other delicate procedures.

REF	Description	Type	Tips	Length
5-70	Serratex Operating Scissors	straight, one serrated edge	sharp/sharp	5-1/2" (14 cm)
5-72	Serratex Operating Scissors	straight, one serrated edge	sharp/blunt	5-1/2" (14 cm)
5-73	Serratex Operating Scissors	straight, one serrated edge	blunt/blunt	5-1/2" (14 cm)
5-74	Serratex Operating Scissors	curved, one serrated edge	sharp/sharp	5-1/2" (14 cm)
5-76	Serratex Operating Scissors	curved, one serrated edge	sharp/blunt	5-1/2" (14 cm)
5-77	Serratex Operating Scissors	curved, one serrated edge	blunt/blunt	5-1/2" (14 cm)
5-60	Lightweight Operating Scissors	straight, delicate pattern	sharp/sharp	5" (12.7 cm)
5-61	Lightweight Operating Scissors	straight, delicate pattern	sharp/blunt	5" (12.7 cm)
5-62	Lightweight Operating Scissors	straight, delicate pattern	blunt/blunt	5" (12.7 cm)
5-63	Lightweight Operating Scissors	curved, delicate pattern	sharp/sharp	5" (12.7 cm)
5-64	Lightweight Operating Scissors	curved, delicate pattern	sharp/blunt	5" (12.7 cm)
5-65	Lightweight Operating Scissors	curved, delicate pattern	blunt/blunt	5" (12.7 cm)
5-80	Lightweight Operating Scissors	straight, delicate pattern	sharp/sharp	5-1/2" (14 cm)
5-82	Lightweight Operating Scissors	straight, delicate pattern	sharp/blunt	5-1/2" (14 cm)
5-84	Lightweight Operating Scissors	straight, delicate pattern	blunt/blunt	5-1/2" (14 cm)
5-86	Lightweight Operating Scissors	curved, delicate pattern	sharp/sharp	5-1/2" (14 cm)
5-88	Lightweight Operating Scissors	curved, delicate pattern	sharp/blunt	5-1/2" (14 cm)
5-90	Lightweight Operating Scissors	curved, delicate pattern	blunt/blunt	5-1/2" (14 cm)



5-70
5-72
5-73



5-70



5-74
5-76
5-77



5-60
5-61
5-62
5-80
5-82
5-84



5-60



5-63
5-64
5-65
5-86
5-88
5-90

Operating & Dissecting Scissors

REF	Description	Type	Tips	Length
5-100	DEAVER Scissors	straight	sharp/sharp	5-1/2" (14 cm)
5-102	DEAVER Scissors	straight	sharp/blunt	5-1/2" (14 cm)
5-104	DEAVER Scissors	straight	blunt/blunt	5-1/2" (14 cm)
5-106	DEAVER Scissors	curved	sharp/sharp	5-1/2" (14 cm)
5-108	DEAVER Scissors	curved	sharp/blunt	5-1/2" (14 cm)
5-112	MIXTER Scissors	straight	blunt	6-1/4" (15.9 cm)
5-114	MIXTER Scissors	curved	blunt	6-1/4" (15.9 cm)



MAYO Operating & Dissecting Scissors

REF	Description	Type	Length
5-115	MAYO Operating Scissors	straight, heavy pattern, sharp	5-1/2" (14 cm)
5-116	MAYO Operating Scissors	curved, heavy pattern, sharp	5-1/2" (14 cm)
5-120	MAYO Dissecting Scissors	straight, standard beveled blade	5-1/2" (14 cm)
5-122	MAYO Dissecting Scissors	curved, standard beveled blade	5-1/2" (14 cm)
5-124	MAYO Dissecting Scissors	straight, standard beveled blade	6-3/4" (17.1 cm)
5-126	MAYO Dissecting Scissors	curved, standard beveled blade	6-3/4" (17.1 cm)
5-128	MAYO Dissecting Scissors	straight, standard beveled blade	9" (22.9 cm)
5-130	MAYO Dissecting Scissors	curved, standard beveled blade	9" (22.9 cm)
5-132	SERRATEX-MAYO Dissecting Scissors	straight, one fine serrated blade	6-3/4" (17.1 cm)
5-134	SERRATEX-MAYO Dissecting Scissors	curved, one fine serrated blade	6-3/4" (17.1 cm)
5-136	MAYO Dissecting Scissors	straight, rounded blades	5-1/2" (14 cm)
5-138	MAYO Dissecting Scissors	curved, rounded blades	5-1/2" (14 cm)
5-140	MAYO Dissecting Scissors	straight, rounded blades	6-3/4" (17.1 cm)
5-142	MAYO Dissecting Scissors	curved, rounded blades	6-3/4" (17.1 cm)



METZENBAUM Scissors

REF	Description	Type	Length
5-179	METZENBAUM (Lahey) Scissors	straight	5-1/2" (14 cm)
5-180	METZENBAUM Scissors	curved	5-1/2" (14 cm)
5-181	METZENBAUM Scissors	straight	7" (17.8 cm)
5-182	METZENBAUM Scissors	curved	7" (17.8 cm)
5-183	METZENBAUM Scissors	straight, delicate	8" (20.3 cm)
5-184	METZENBAUM Scissors	curved	8" (20.3 cm)
5-185	METZENBAUM Scissors	curved, delicate	8" (20.3 cm)
5-186	METZENBAUM (Nelson) Scissors	straight	9" (22.9 cm)
5-187	METZENBAUM Scissors	straight, delicate	9" (22.9 cm)
5-188	METZENBAUM (Nelson) Scissors	curved	9" (22.9 cm)
5-189	METZENBAUM Scissors	curved, delicate	9" (22.9 cm)
5-190	METZENBAUM (Nelson) Scissors	straight	11" (27.9 cm)
5-192	METZENBAUM (Nelson) Scissors	curved	11" (27.9 cm)
5-193	METZENBAUM Scissors	curved, delicate	11" (27.9 cm)
5-194	METZENBAUM (Nelson) Scissors	straight	14-1/2" (36.8 cm)
5-196	METZENBAUM (Nelson) Scissors	curved	14-1/2" (36.8 cm)
5-283	METZENBAUM Scissors	straight, delicate	5" (12.7 cm)
5-284	METZENBAUM Scissors	curved, delicate	5" (12.7 cm)
5-286	METZENBAUM Scissors	curved, delicate	6" (15.2 cm)
5-288	METZENBAUM Scissors	curved, delicate	7" (17.8 cm)



Operating & Dissecting Scissors

REF	Description	Type	Length
5-144	MAYO-NOBLE Dissecting Scissors	straight, rounded blades	6-1/2" (16.5 cm)
5-146	MAYO-NOBLE Dissecting Scissors	curved, rounded blades	6-1/2" (16.5 cm)
5-148	MAYO-NOBLE Dissecting Scissors	straight, beveled blades	6-1/2" (16.5 cm)
5-150	MAYO-NOBLE Dissecting Scissors	curved, beveled blades	6-1/2" (16.5 cm)
5-152	SISTRUNK Operating Scissors	straight	5-1/2" (14 cm)
5-154	SISTRUNK Operating Scissors	slightly curved	5-1/2" (14 cm)
5-160	DOYEN Abdominal Scissors	straight	7" (17.8 cm)
5-162	DOYEN Abdominal Scissors	curved	7" (17.8 cm)



Operating & Dissecting Scissors

REF	Description	Type	Length
5-172	REYNOLDS Dissecting Scissors	curved, tenotomy type tips	6" (15.2 cm)
5-174	REYNOLDS Dissecting Scissors	curved, tenotomy type tips, one serrated blade	6" (15.2 cm)
5-176	REYNOLDS Dissecting Scissors	curved, tenotomy type tips	7" (17.8 cm)
5-178	REYNOLDS Dissecting Scissors	curved, tenotomy type tips, one serrated blade	7" (17.8 cm)
5-246	POTTS-SMITH Scissors	angled on side 25°, 20 mm blades	7-1/2" (19.1 cm)
5-247	POTTS-SMITH Scissors	angled on side 45°, 20 mm blades	7-1/2" (19.1 cm)
5-248	POTTS-SMITH Scissors	angled on side 60°, 20 mm blades	7-1/2" (19.1 cm)
5-249A	POTTS-SMITH Scissors	delicate, angled on side 25°, 13 mm blades	7" (17.8 cm)
5-249B	POTTS-SMITH Scissors	delicate, angled on side 45°, 13 mm blades	7" (17.8 cm)
5-249C	POTTS-SMITH Scissors	delicate, angled on side 60°, 13 mm blades	7" (17.8 cm)



Operating & Dissecting Scissors

REF	Description	Type	Length
5-250	KELLY Scissors	straight, sharp tips	6-1/4" (15.9 cm)
5D-251	KELLY Scissors	straight, sharp tips, one serrated blade	6-1/4" (15.9 cm)
5-252	KELLY Scissors	curved, sharp tips	6-1/4" (15.9 cm)
5D-253	KELLY Scissors	curved, sharp tips, one serrated blade	6-1/4" (15.9 cm)
5-254	KELLY Scissors	sharp tips, angled on side	6-1/4" (15.9 cm)
5D-255	KELLY Scissors	sharp tips, angled on side, one serrated blade	6-1/4" (15.9 cm)
5-256	BOETTCHER Dissecting Scissors	curved, double edged, Saber-Back blade	7-1/4" (18.4 cm)
5-262	STRULLY Dissecting Scissors	slightly curved blades with probe tips	8" (20.3 cm)
5-263	KAYE Fine Dissecting Scissors	one serrated blade, ribbon type	4-1/4" (10.8 cm)



Operating & Dissecting Scissors

REF	Description	Type	Length
5-264	DEAN Dissecting Scissors	blades angled on flat, one serrated blade	6-3/4" (17.1 cm)
5-265	KAHN Dissecting Scissors	straight, Saber-Back blade	5-1/2" (14 cm)
5-266	KAHN Dissecting Scissors	curved, Saber-Back blade	5-1/2" (14 cm)
5-267	KAHN Dissecting Scissors	straight, Saber-Back blade	7" (17.8 cm)
5-268	KAHN Dissecting Scissors	curved, Saber-Back blade	7" (17.8 cm)
5-290	RAGNELL Dissecting Scissors	curved, flat tip	5" (12.7 cm)
5-291	RAGNELL Dissecting Scissors	curved, flat tip	7" (17.8 cm)



5-264



5-266
5-268

5-265
5-267



5-290
5-291

Operating & Dissecting Scissors

REF	Description	Type	Tips	Length
34-92	RICHTER Dissecting Scissors	angular	sharp/blunt	5" (12.7 cm)
PM-6535*	CLODIUS Dissecting Scissors	curved	sharp	6" (15.2 cm)

* **PADGETT**
INSTRUMENTS® By *Miltex*



34-92



PM-6535

Plastic Surgery Scissors

REF	Description	Type	Tips	Blade	Length
5-270	Plastic Surgery Scissors	straight	sharp/sharp	-	4-3/4" (12.1 cm)
5-271	Plastic Surgery Scissors	straight	sharp/sharp	serrated blade	4-3/4" (12.1 cm)
5-272	Plastic Surgery Scissors	straight	sharp/blunt	-	4-3/4" (12.1 cm)
5-273	Plastic Surgery Scissors	straight	sharp/blunt	serrated blade	4-3/4" (12.1 cm)
5-274	Plastic Surgery Scissors	straight	blunt/blunt	-	4-3/4" (12.1 cm)
5-275	Plastic Surgery Scissors	straight	blunt/blunt	serrated blade	4-3/4" (12.1 cm)
5-276	Plastic Surgery Scissors	curved	sharp/sharp	-	4-3/4" (12.1 cm)
5-277	Plastic Surgery Scissors	curved	sharp/sharp	serrated blade	4-3/4" (12.1 cm)
5-278	Plastic Surgery Scissors	curved	sharp/blunt	-	4-3/4" (12.1 cm)
5-279	Plastic Surgery Scissors	curved	sharp/blunt	serrated blade	4-3/4" (12.1 cm)
5-280	Plastic Surgery Scissors	curved	blunt/blunt	-	4-3/4" (12.1 cm)
5-281	Plastic Surgery Scissors	curved	blunt/blunt	serrated blade	4-3/4" (12.1 cm)



Sharp/Sharp



Sharp/Blunt



Blunt/Blunt



5-270
5-271
5-272
5-273
5-274
5-275



5-276
5-277
5-278
5-279
5-280
5-281



5-270

General Surgery Scissors

REF	Description	Type	Tips	Length
5-200	HARRINGTON Scissors	straight	-	11-1/2" (29.2 cm)
5-202	HARRINGTON Scissors	curved	-	11-1/2" (29.2 cm)
5-220	SIMS Scissors	straight	sharp/sharp	8" (20.3 cm)
5-222	SIMS Scissors	straight	sharp/blunt	8" (20.3 cm)
5-226	SIMS Scissors	curved	sharp/sharp	8" (20.3 cm)
5-243	JORGENSEN Scissors	strongly curved blades	-	9" (22.9 cm)
5-244	THOREK Scissors	full curve	-	7-1/4" (18.4 cm)
5-245	THOREK Scissors	full curve	-	10" (25.4 cm)



General Surgery Scissors

REF	Description	Type	Tips	Length
18-1430	Eye Scissors	straight	with probe tip	4" (10.2 cm)
18-1432	Eye Scissors	curved	with probe tip	4" (10.2 cm)
18-1440	WILMER (Converse) Conjunctival and Utility Scissors	angled on flat	-	4" (10.2 cm)
18-1453	Strabismus Scissors	straight, ribbon-type	-	4-1/4" (10.8 cm)
18-1454	Strabismus Scissors	curved, ribbon-type	-	4-1/4" (10.8 cm)
18-1455	STEVENS Tenotomy Scissors	curved	blunt	5-1/2" (14 cm)
18-1456	STEVENS Tenotomy Scissors	curved	blunt	6-1/4" (15.9 cm)
18-1460	STEVENS Tenotomy Scissors	straight, short blades	sharp	4-1/8" (10.5 cm)
18-1462	STEVENS Tenotomy Scissors	straight, short blades	blunt	4-1/8" (10.5 cm)
18-1464	STEVENS Tenotomy Scissors	curved, short blades	sharp	4-1/8" (10.5 cm)
18-1466	STEVENS Tenotomy Scissors	curved, short blades	blunt	4-1/8" (10.5 cm)
18-1470	STEVENS Tenotomy Scissors	straight, long blades	sharp	4-1/2" (11.4 cm)
18-1472	STEVENS Tenotomy Scissors	straight, long blades	blunt	4-1/2" (11.4 cm)
18-1474	STEVENS Tenotomy Scissors	curved, long blades	sharp	4-1/2" (11.4 cm)
18-1476	STEVENS Tenotomy Scissors	curved, long blades	blunt	4-1/2" (11.4 cm)
18-1477	STEVENS Tenotomy Scissors	straight, ribbon-type	blunt	3-3/4" (9.5 cm)
18-1478	STEVENS Tenotomy Scissors	curved, ribbon-type	blunt	3-3/4" (9.5 cm)



18-1430

18-1432



18-1440



18-1453

18-1454



18-1460
18-1462

18-1455
18-1456
18-1464
18-1466



18-1470
18-1472

18-1474
18-1476



18-1477

18-1478

General Surgery Scissors

REF	Description	Type	Blade	Length
5-320	GOLDMAN-FOX Wound Debridement Scissors	curved fine tips	one serrated blade	5" (12.7 cm)
5D-322	GOLDMAN-FOX Wound Debridement Scissors	curved fine tips	one serrated blade, angled shanks	5" (12.7 cm)
5D-324	LA GRANGE Scissors	curved	one serrated blade, angled shanks	4-1/4" (10.8 cm)



5-320



5D-322



5D-324

General Surgery Scissors

REF	Description	Type	Length
21-605	MILTEX Rhytidectomy Scissors, Saber-Back	curved	6-1/2" (16.5 cm)
21-607	GORNEY Facelift Scissors, Saber-Back	straight, one serrated blade	7-3/4" (19.7 cm)
21-608	GORNEY Facelift Scissors, Saber-Back	slightly curved, one serrated blade	7-3/4" (19.7 cm)
22-962	LILLY Dissecting & Tonsil Scissors, Saber-Back	strong curve	7-1/2" (19.1 cm)



21-605



21-607



21-608



22-962

General Surgery Scissors

REF	Description	Type	Length
33-240	BIRO Dermal Naevus Scissors	angled on flat, sharp	4" (10.2 cm)
33-242	MILTEX Undermining Scissors	curved blades with flat, pointed tip	4-1/2" (11.4 cm)
34-98	Enterotomy Scissors	with hook blade	8-1/4" (21 cm)
25-1240B	DEBAKEY-POTTS Scissors	angled 45°, blunt	6-3/4" (17.1 cm)
27-1000	MARTIN Cartilage Scissors	curved, serrated non-slip cutting edge	8" (20.3 cm)
40-460	Moleskin & Felt Scissors	straight, sharp/blunt point	7-1/2" (19.1 cm)



33-240



33-242



34-98



25-1240B



27-1000



40-460

Suture Scissors

REF	Description	Type	Blade	Length
9-96	HEATH Suture Scissors	-	serrated blade	6-1/8" (15.6 cm)
9-98	NEW'S Suture Scissors	angled on flat	-	5-1/2" (14 cm)
PM-6770*	LASCHAL Suture Scissors/Forceps	straight	-	4-1/2" (11.4 cm)
PM-6780*	LASCHAL Suture Cutter	straight	-	6" (15.2 cm)

* **PADGETT** INSTRUMENTS[®] By *Miltex*



9-96



9-98



PM-6770



PM-6780

Stitch & Wire Cutting Scissors

REF	Description	Type	Length
9-100	SPENCER Stitch Scissors	straight, delicate	3-1/2" (8.9 cm)
PM-6751*	SPENCER Stitch Scissors	curved on flat	3-1/2" (8.9 cm)
9-101	SHORTBENT Stitch Scissors	curved on flat, delicate	3-1/2" (8.9 cm)
9-102	LITTAUER JR. Stitch Scissors	straight, light pattern	4-1/2" (11.4 cm)
9-103	NORTHBENT Stitch Scissors	curved, light pattern	4-3/4" (12.1 cm)
9-104	LITTAUER Stitch Scissors	straight, standard pattern	5-1/2" (14 cm)

*  **PADGETT**
INSTRUMENTS By *Miltex*



9-100



PM-6751



9-101



9-102



9-103



9-104

Stitch & Wire Cutting Scissors

REF	Description	Type	Length
9-106	LONG Oral Surgery Stitch Scissors	straight	6" (15.2 cm)
9-108	MILTEX Stitch Scissors	angled, delicate	4-1/2" (11.4 cm)
9D-115	RA Matrix Scissors	45° angle, one serrated blade	4-1/4" (10.8 cm)
9-115	REEH Stitch Scissors	curved, small hook, sharp tips, ribbon-type	3-3/4" (9.5 cm)
9-116	MILTEX Stitch Scissors	curved, no hook, sharp tips, ribbon-type	3-7/8" (9.8 cm)
9-117	MILTEX Stitch Scissors	curved, no hook, sharp tips, ribbon-type	4-1/2" (11.4 cm)



9-106



9-108



9D-115



9-115



9-116



9-117

MILTEX® Stitch & Wire Cutting Scissors

REF	Description	Type	Length
9-120	MILTEX Wire Cutting Scissors	straight, one serrated blade	4-3/4" (12.1 cm)
9D-121	MILTEX Wire Cutting Scissors	straight	4-3/4" (12.1 cm)
9-122	MILTEX Wire Cutting Scissors	curved, one serrated blade	4-3/4" (12.1 cm)
9D-123	MILTEX Wire Cutting Scissors	curved	4-3/4" (12.1 cm)
9-124	MILTEX Wire Cutting Scissors	angled to side, serrated blade	4-3/4" (12.1 cm)
9D-123	MILTEX Wire Cutting Scissors	curved	4-3/4" (12.1 cm)
9D-132	MILTEX Wire Cutting Scissors	straight, serrated blade	4-1/4" (10.8 cm)
9D-133	MILTEX Wire Cutting Scissors	straight	4-1/4" (10.8 cm)
9D-134	MILTEX Wire Cutting Scissors	curved, serrated blade	4-1/4" (10.8 cm)
9D-135	MILTEX Wire Cutting Scissors	curved	4-1/4" (10.8 cm)



9-120
9D-121

9-122
9D-123



9-124



9D-132
9D-133



9D-134
9D-135

Iris Scissors

Ribbon -Type Scissors have extra large finger rings.

REF	Description	Type	Length
18-1392	BONN Miniature Iris Scissors	straight, with 15 mm blades	3-1/2" (8.9 cm)
18-1394	BONN Miniature Iris Scissors	curved, with 15 mm blades	3-1/2" (8.9 cm)
18-1396	Iris Scissors	straight, delicate, with 20 mm blades	3-1/2" (8.9 cm)
18-1398	Iris Scissors	curved, delicate, with 20 mm blades	3-1/2" (8.9 cm)
18-1404	MILTEX Iris Scissors	straight, heavy pattern	4" (10.2 cm)
18-1405	MILTEX Iris Scissors	curved, heavy pattern	4" (10.2 cm)
18-1415	Iris Scissors	straight, ribbon-type, standard pattern	4" (10.2 cm)
18-1416	Iris Scissors	curved, ribbon-type, standard pattern	4" (10.2 cm)
18-1417	Iris Scissors	straight, ribbon-type, miniature pattern	3-3/4" (9.5 cm)
18-1418	Iris Scissors	curved, ribbon-type, miniature pattern	3-3/4" (9.5 cm)
18-1419	Iris Utility Scissors	curved, ribbon-type, with 15 mm blades	3-3/4" (9.5 cm)
18-1420	KNAPP Iris Scissors	straight, sharp/blunt	4" (10.2 cm)
18-1422	KNAPP Iris Scissors	straight, blunt/blunt	4" (10.2 cm)
18-1426	KNAPP Iris Scissors	curved, sharp/blunt	4" (10.2 cm)
18-1428	KNAPP Iris Scissors	curved, blunt/blunt	4" (10.2 cm)



Eye Scissors

REF	Description	Type	Length
5-300	Iris Scissors	straight	4" (10.2 cm)
5-302	Iris Scissors	curved	4" (10.2 cm)
5-304	Iris Scissors	straight	4-1/2" (11.4 cm)
5-306	Iris Scissors	curved	4-1/2" (11.4 cm)
5-308	Iris Scissors	angled on side	4-1/2" (11.4 cm)
5D-303	Iris Operating Scissors	curved sideways	4-1/2" (11.4 cm)
5-310	Eye Scissors with probe points	angled on side	4-1/2" (11.4 cm)
5-312	Strabismus Scissors	straight	4" (10.2 cm)
5-314	Strabismus Scissors	curved	4" (10.2 cm)
5-316	BROPHY Scissors	straight, sharp	5-1/2" (14 cm)
5-318	BROPHY Scissors	curved, sharp	5-1/2" (14 cm)



Enucleation Scissors

REF	Description	Type	Length
18-1494	Enucleation Scissors	light curve	5" (12.7 cm)
18-1496	Enucleation Scissors	medium curve	5" (12.7 cm)
18-1498	Enucleation Scissors	full curve	5" (12.7 cm)



18-1494



18-1496



18-1498

Eye & ENT Scissors

REF	Description	Type	Length
18-1594	McGUIRE Corneal Scissors	right	4-1/8" (10.5 cm)
18-1600	AEBLI Corneal Scissors	straight	4" (10.2 cm)
18-1620	VANNAS Capsulotomy Scissors	straight, extra delicate, sharp	3-1/4" (8.3 cm)
18-1622	VANNAS Capsulotomy Scissors	curved, extra delicate, sharp	3-1/4" (8.3 cm)
20-168	SEILER Turbinate Scissors	angled on side	6-1/4" (15.9 cm)
21-539	KLEINERT-KUTZ Tenotomy Scissors	curved, rounded dissecting blades	4-7/8" (12.4 cm)
21-560	TAYLOR Dural Scissors	angled with probe tip	5-1/2" (14 cm)
21-600	FOMON Scissors, Saber-Back	slightly curved, semi-sharp outer edges	5" (12.7 cm)
21-602	FOMON Lower Lateral Scissors	full curve	5" (12.7 cm)



18-1594



18-1600



18-1620

18-1622



20-168



21-539



21-560



21-600

21-602

Microsurgery Scissors

REF	Description	Type	Tips	Length
18-1510	NOYES Iris Scissors	straight	sharp/sharp	4-1/2" (11.4 cm)
18-1512	NOYES Iris Scissors	straight	sharp/blunt	4-1/2" (11.4 cm)
18-1514	NOYES Iris Scissors	straight	blunt/blunt	4-1/2" (11.4 cm)
18-1516	NOYES (ROSS) Iris Scissors	curved	sharp/sharp	4-1/2" (11.4 cm)
18-1524	DeWECKER Iris Scissors	angled 7 mm blades	sharp/sharp	4-1/4" (10.8 cm)
18-1554	McCLURE Iris Scissors	angled on flat, regular 10 mm blades, sharp	-	4-1/2" (11.4 cm)
18-1558	CASTROVIEJO Corneal Scissors	right, for microsurgery, 6 mm blades	-	4" (10.2 cm)
18-1559	CASTROVIEJO Corneal Scissors	left, for microsurgery, 6 mm blades	-	4" (10.2 cm)

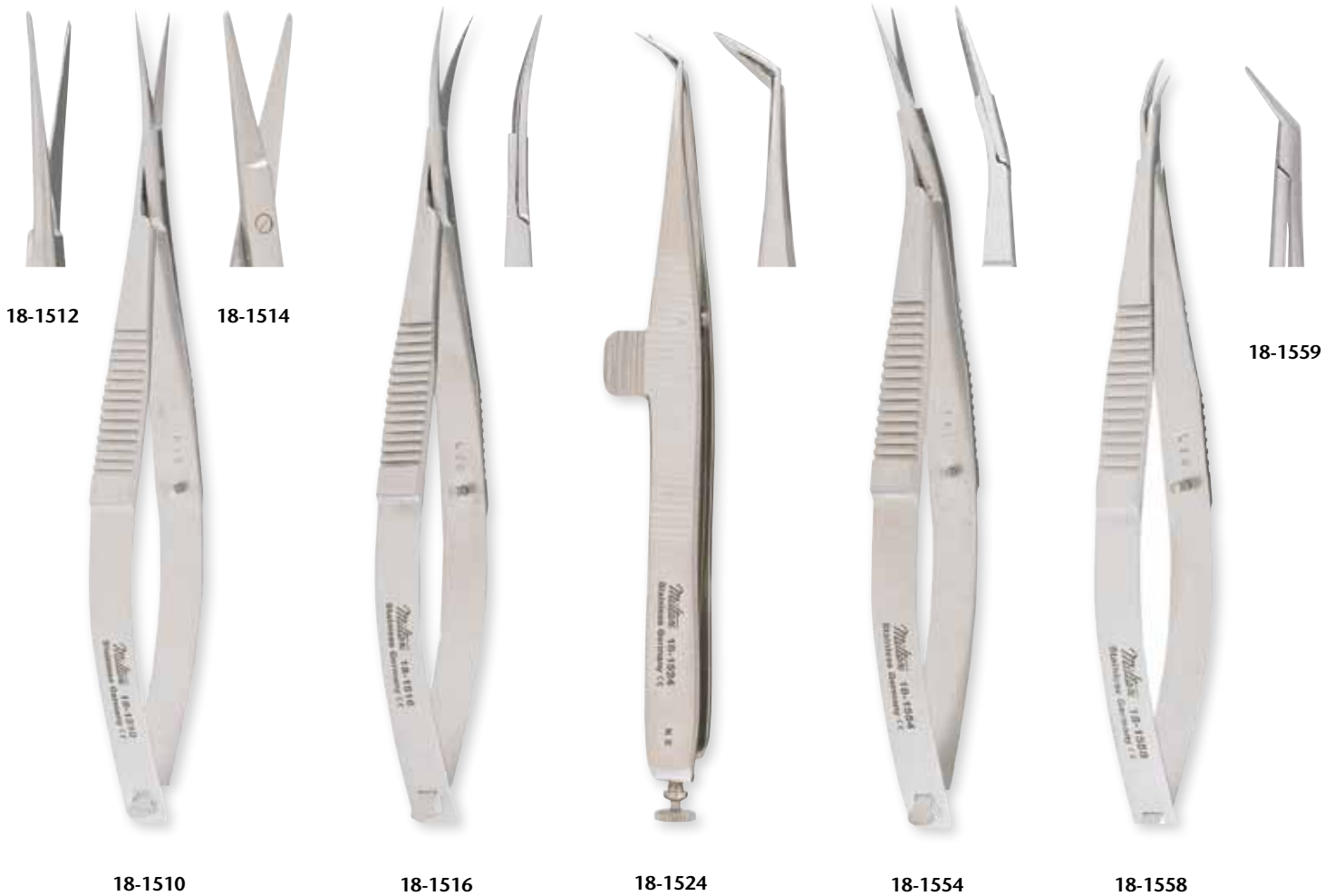

Microsurgery Scissors

REF	Description	Type	Tips	Length
17-2040	MILTEX Microsurgery Scissors	curved, 8 mm blades, flat handles	sharp	5-3/4" (14.6 cm)
17-2060	MILTEX Microsurgery Scissors	straight, 8 mm blades, flat handles	sharp	5-3/4" (14.6 cm)
17-2100	MILTEX Microsurgery Scissors	curved, 6 mm blades, round handles	sharp	6" (15.2 cm)
17-2150	MILTEX Microsurgery Scissors	straight, 6 mm blades, round handles	sharp	6" (15.2 cm)
17-2110	MILTEX Microsurgery Scissors	curved, 6 mm blades, round handles	sharp	7-1/8" (18.1 cm)
17-2160	MILTEX Microsurgery Scissors	straight, 6 mm blades, round handles	sharp	7-1/8" (18.1 cm)
18-1480	WESTCOTT Utility Scissors	curved	blunt	4-1/2" (11.4 cm)
18-1486	WESTCOTT Stitch Scissors	curved	sharp	4-1/2" (11.4 cm)
18-1487	WESTCOTT Tenotomy Scissors	right, wide handles	-	5-1/4" (13.3 cm)
18-1488	WESTCOTT Tenotomy Scissors	left, wide handles	-	5-1/4" (13.3 cm)



17-2060

17-2040



17-2150
17-2160

17-2100
17-2110



18-1480

18-1486



18-1487
18-1488



Microsurgery Scissors

REF	Description	Type	Length
18-1560	CASTROVIEJO Corneal Section Scissors	right, inner blade 1 mm longer, blunt	4-1/2" (11.4 cm)
18-1562	CASTROVIEJO Corneal Section Scissors	left, inner blade 1 mm longer, blunt	4-1/2" (11.4 cm)
18-1570	CASTROVIEJO Keratoplasty Scissors	angled blades, 11 mm, sharp	3-3/4" (9.5 cm)
18-1576	CASTROVIEJO Corneal Scissors	curved, sharp	3-3/4" (9.5 cm)
18-1578	CASTROVIEJO Corneal Scissors	curved, blunt	3-3/4" (9.5 cm)
18-1618	Micro Iris Scissors	straight, sharp	4" (10.2 cm)
18-1619	Micro Iris Scissors	curved, sharp	4" (10.2 cm)
18-1625	McPHERSON-VANNAS Micro Iris Scissors	straight sharp	3-1/4" (8.3 cm)
18-1626	McPHERSON-VANNAS Micro Iris Scissors	curved, sharp	3-1/4" (8.3 cm)
18-1630	Micro VANNAS Scissors	straight, ultra fine blades	3-1/4" (8.3 cm)
18-1631	Micro VANNAS Scissors	curved, ultra fine blades	3-1/4" (8.3 cm)
18-1633	Micro Scissors	straight, super fine blades	3-1/4" (8.3 cm)
18-1634	Micro Scissors	curved, super fine blades	3-1/4" (8.3 cm)
18-1652	Eye Suture (GRADLE) Scissors	slightly curved, sharp	3-3/4" (9.5 cm)
18-1653	Eye Suture Scissors	slightly curved, sharp, ribbon type	4" (10.2 cm)



18-1560

18-1562



18-1576
18-1578



18-1618



18-1619



18-1625



18-1630



18-1631



18-1633



18-1634



18-1652



18-1653

Specialty Scissors & Cutting Instruments

REF	Description	Type	Length
1700	Utility Scissors	straight, heavy pattern, sharp/blunt	6-1/2" (16.5 cm)
1702	Utility Scissors	straight, heavy pattern, blunt/blunt	6-1/2" (16.5 cm)
1704	Utility Scissors	curved, heavy pattern, sharp/blunt	6-1/2" (16.5 cm)
1706	Utility Scissors	curved, heavy pattern, blunt/blunt	6-1/2" (16.5 cm)
1718-SS	WHITE Toenail Scissors	-	4-1/2" (11.4 cm)
1720	Small Animal Toenail Nipper	with latch lock	5-1/4" (13.3 cm)
33-140	Ring Cutter	with circular saw blade, chrome	6-1/2" (16.5 cm)
33-142	Replacement Blade for Finger Ring Cutter	chrome	-
40-425	Nail Scissors	curved, chrome	3-1/2" (8.9 cm)
40-435	Cuticle Scissors	curved, standard	3-1/2" (8.9 cm)
40-445	Cuticle Scissors	curved, extra delicate	3-1/2" (8.9 cm)



BELLUCCI Alligator & Nasal Scissors

REF	Description	Type	Blade	Shaft Length
19-2155	BELLUCCI Alligator Scissors	curved left	7 mm	3" (7.6 cm)
19-2156	BELLUCCI Alligator Scissors	curved right	7 mm	3" (7.6 cm)
19-2160	BELLUCCI Alligator Scissors	straight	7 mm	3" (7.6 cm)
19-2157	HOUSE-BELLUCCI Alligator Scissors	straight	5 mm	3" (7.6 cm)
19-2158	HOUSE-BELLUCCI Alligator Scissors	curved left	5 mm	3" (7.6 cm)
19-2159	HOUSE-BELLUCCI Alligator Scissors	curved right	5 mm	3" (7.6 cm)
20-170	Nasal Scissors	straight	11 mm	4-1/4" (10.8 cm)
20-171	Nasal Scissors	left	11 mm	4-1/4" (10.8 cm)
20-172	Nasal Scissors	right	11 mm	4-1/4" (10.8 cm)

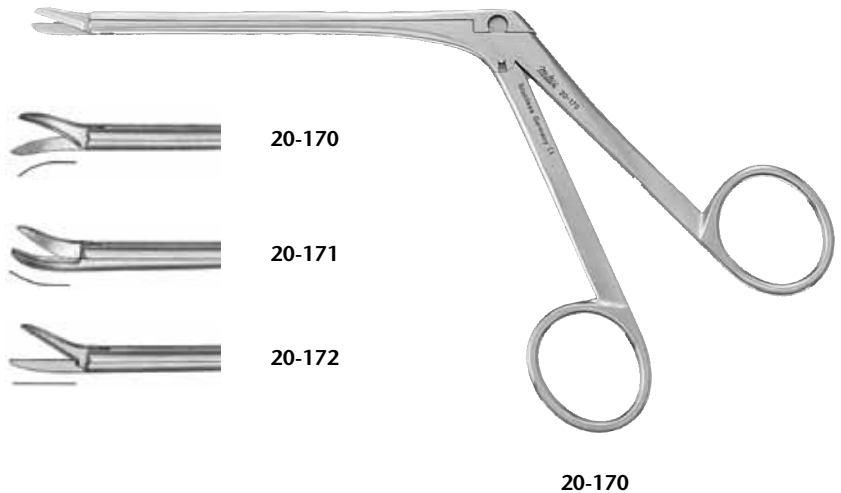
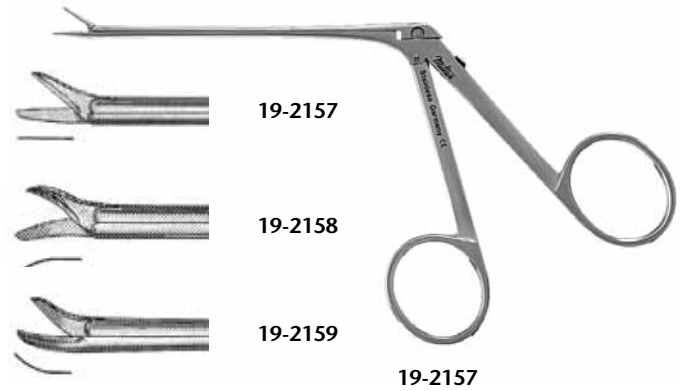
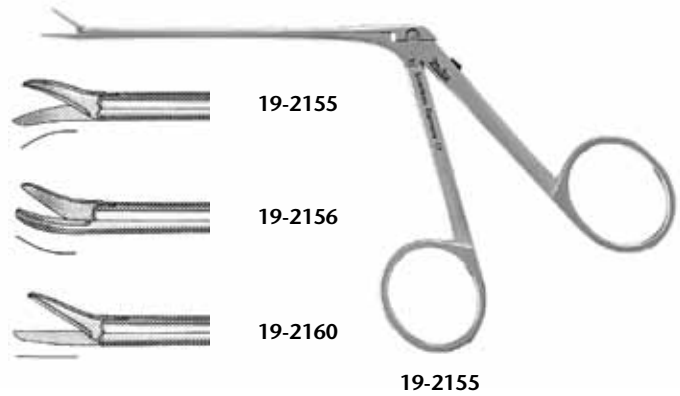

Bandage & Utility Scissors

REF	Description	Type	Length
5-510	LISTER Bandage Scissors	extra fine	3-1/2" (8.9 cm)
5-512	LISTER Bandage Scissors	extra fine	4-1/2" (11.4 cm)
5-514	LISTER Bandage Scissors	extra fine	5-1/2" (14 cm)
5-516	LISTER Bandage Scissors	extra fine	7-1/4" (18.4 cm)
5-550	LISTER Bandage Scissors	with one large finger ring	8" (20.3)
5-547	HERCULES Heavy Duty Bandage & Plaster Shears	serrated blade	7-1/2" (19.1 cm)



5-510
5-512
5-514
5-516



5-550



5-547

Bandage & Utility Scissors

REF	Description	Type	Length
5-560	KNOWLES Bandage Scissors	straight	5-1/2" (14 cm)
5-561	KNOWLES Bandage Scissors	shank angled on side, serrated blade	5-1/2" (14 cm)
PM-4841*	PANTZER Hi-Level Bandage Scissors	shank angled on side, serrated	5-1/2" (14 cm)
21-560	TAYLOR Dural Scissors (ideal for feline)	with probe tip	6-1/2" (16.5 cm)
5-564	U.S.A. Gauze Scissors	chrome	8" (20.3 cm)
5-568	ESMARCH Heavy Duty Bandage & Cast Shears	-	8" (20.3 cm)

* **PADGETT** INSTRUMENTS By *Miltex*



5-560



5-561



PM-4841



21-560



5-564



5-568

Bandage & Utility Scissors

Miltex offers fluoride coated blades to help prevent adhesive from sticking to blade surfaces.

REF	Description	Type	Length
5-700	Nurse's Bandage Scissors	fluoride coated, pink handle	5-1/2" (14 cm)
5-702	Nurse's Bandage Scissors	fluoride coated, blue handle	5-1/2" (14 cm)
5703	Nurse's Bandage Scissors	fluoride coated, black handle	5-1/2" (14 cm)
5704	Nurse's Bandage Scissors	fluoride coated, neon green handle	5-1/2" (14 cm)
5705	Nurse's Bandage Scissors	fluoride coated, lavender handle	5-1/2" (14 cm)
5803	Bandage and Utility Scissors	fluoride coated, hot pink handle	8" (20.3 cm)
5804	Bandage and Utility Scissors	fluoride coated, bright blue handle	8" (20.3 cm)
5801	Bandage and Utility Scissors	fluoride coated, black handle	8" (20.3 cm)
5-800	Bandage and Utility Scissors	fluoride coated, neon green handle	8" (20.3 cm)
5802	Bandage and Utility Scissors	fluoride coated, lavender handle	8" (20.3 cm)
5-998	Bandage and Utility Scissors	needle destroyer, serrated, black handle	6-1/2" (16.5 cm)
5-1000	Bandage and Utility Scissors	needle destroyer, serrated, black handle	7-1/2" (19.1 cm)
5-1025	Universal Scissors	needle destroyer, serrated, red handle	7-1/2" (19.1 cm)
5-1026	Universal Scissors	needle destroyer, serrated, orange handle	7-1/2" (19.1 cm)
5-1027	Universal Scissors	needle destroyer, serrated, blue handle	7-1/2" (19.1 cm)
5-1028	Universal Scissors	needle destroyer, serrated, purple handle	7-1/2" (19.1 cm)
5-1029	Universal Scissors	needle destroyer, serrated, green handle	7-1/2" (19.1 cm)
5-1030	Universal Scissors	needle destroyer, serrated, yellow handle	7-1/2" (19.1 cm)

* Note: All Miltex Bandage Scissors are Autoclavable



5-600



5-700 to 5705



5803 to 5-800



5-998



5-1000 to 5-1030

Specialty Rib Shears

REF	Description	Length
25-362	STILLE Pattern Rib Shears	8-1/2" (21.6 cm)
25-378	STILLE-GIERTZ Rib Shears	10" (25.4 cm)



25-362



25-378

Cast Instruments

REF	Description	Type	Length
27-3060	STILLE Plaster & Cast Shears	medium size, serrated blades	11" (27.9 cm)
27-3070	BRUNS Plaster & Cast Shears	serrated blade	9-1/4" (23.5 cm)
27-3100	MILTEX 3-Prong Cast Spreader	with spring action for one handed operation	9" (22.9 cm)



27-3060



27-3070



27-3100

MILTEX® FORCEPS

Premium Dressing & Tissue Forceps.....	53-56
Dressing & Tissue Forceps	57-76
Splinter Forceps.....	77-79
Microsurgical Forceps.....	80-81
Hemostatic Forceps	82-99
Hemostatic Clamps	100
Towel Clamps & Forceps.....	101
Sponge Forceps.....	102-103



ANATOMY OF MILTEX® FORCEPS

The Miltex Repair and Service Team offers extensive instrument refurbishment and tungsten carbide jaw replacement services. Contact us for more information.



CARB-N-SERT® (Tungsten Carbide Tips)

Carb-N-Sert® tips are made of tungsten carbide, the hardest steel made for surgical instruments.

Serrations are precision milled into the tungsten carbide material and form pyramid-shaped teeth to provide a positive non-slip grip. Tissue forceps feature precision formed teeth with perfect alignment to provide a durable and reliable grasp of the most delicate or toughest tissue, as well as needles, suture, dressing and delicate vessels.

SPRING TENSION

Proper tension maintains the desired distance between handles and provides a comfortable grasp without requiring unnecessary pressure to close the instrument.

LASER ETCHING

All Miltex forceps are laser etched with our logo and catalog number for easy re-ordering reference. Advanced laser techniques no longer harm instruments the way traditional acid etching techniques did.

SATIN FINISH

Each instrument is satin finished to reduce glare.

TANG

Evenly welded and finished with rounded edges for dissecting. Gold finished handles identify these forceps as precision instruments.

** Note: cold or chemical sterilization is not recommended for tungsten carbide instruments*

Dressing & Tissue Forceps

Miltex® Forceps with tungsten carbide jaws provide considerably longer service life and will maintain a firm and reliable grasping surface.

REF	Description	Teeth	Type	Tip	Length
6-30TC	Dressing Forceps	-	cross-serrated	Carb-N-Sert	6" (15.2 cm)
6-113TC	HUDSON (Ewald) Dressing Forceps	-	cross-serrated	Carb-N-Sert	6" (15.2 cm)
6-115TC	HUDSON (Ewald) Tissue & Suture Forceps	1 x 2	cross-serrated tying platform	Carb-N-Sert	6" (15.2 cm)
6-118TC	ADSON Dressing Forceps	-	cross-serrated	Carb-N-Sert	4-3/4" (12.1 cm)
6-129TC	ADSON Dressing Forceps	-	cross-serrated	Carb-N-Sert	6" (15.2 cm)
6-123TC	ADSON Tissue & Suture Forceps	1 x 2	cross-serrated tying platform	Carb-N-Sert	4-3/4" (12.1 cm)



6-30TC



6-113TC



6-115TC



6-118TC



6-129TC



6-123TC

Dressing & Tissue Forceps

REF	Description	Teeth	Type	Tip	Length
6-124TC	BROWN-ADSON Tissue and Suture Forceps	7 x 7	side grasping teeth & cross-serrated tying platform	Carb-N-Sert	4-3/4" (12.1 cm)
6-130TC	ADSON Tissue and Suture Forceps	1 x 2	cross-serrated tying platform	Carb-N-Sert	6" (15.2 cm)
6-154TC	POTTS-SMITH Dressing Forceps	-	cross-serrated	Carb-N-Sert	7" (17.8 cm)
6-156TC	POTTS-SMITH Dressing Forceps	-	cross-serrated	Carb-N-Sert	8-1/4" (21 cm)
6-158TC	POTTS-SMITH Dressing Forceps	-	cross-serrated	Carb-N-Sert	9-3/4" (24.8 cm)
6-165TC	EVANS Pelvic Tissue Forceps	-	cross-serrated	Carb-N-Sert	10" (25.4 cm)
6-166TC	CUSHING Dressing Forceps	-	Gutch handle, cross-serrated	Carb-N-Sert	7" (17.8 cm)
6-198TC	ADSON Bayonet Dressing Forceps	-	Gutch handle, cross-serrated	Carb-N-Sert	8-1/2" (21.6 cm)



6-124TC

6-130TC

6-154TC
6-156TC
6-158TC

6-165TC

6-166TC

6-198TC

PADGETT Dressing & Tissue Forceps

REF	Description	Teeth	Type	Tip	Length
PM-2511	GORNEY-ADSON Forceps	1 x 2	with smooth tying platform	Carb-N-Sert	4-3/4" (12.1 cm)
PM-3503	BROWN-ADSON Forceps	4 x 4	side grasping teeth with cross-serrated tying platform	Carb-N-Sert	4-3/4" (12.1 cm)
PM-4697	Jeweler's Dilator Forceps	-	-	Diamond Dust	4-1/2" (14.1 cm)
PM-4698	Jeweler's Forceps #4	-	-	Diamond Dust	4" (10.2 cm)
PM-4699	Jeweler's Forceps #5A	-	-	Diamond Dust	4-1/4" (10.8 cm)
PM-9043	Crow Coagulating Forceps	-	ESU Insulated, cross-serrated	Carb-N-Sert	9" (22.9 cm)
PM-3504	REES Bayonet Forceps	-	cross-serrated	Carb-N-Sert	5-1/2" (14 cm)
PM-3505	REES Bayonet Forceps	-	cross-serrated	Carb-N-Sert	6-1/2" (15.9 cm)

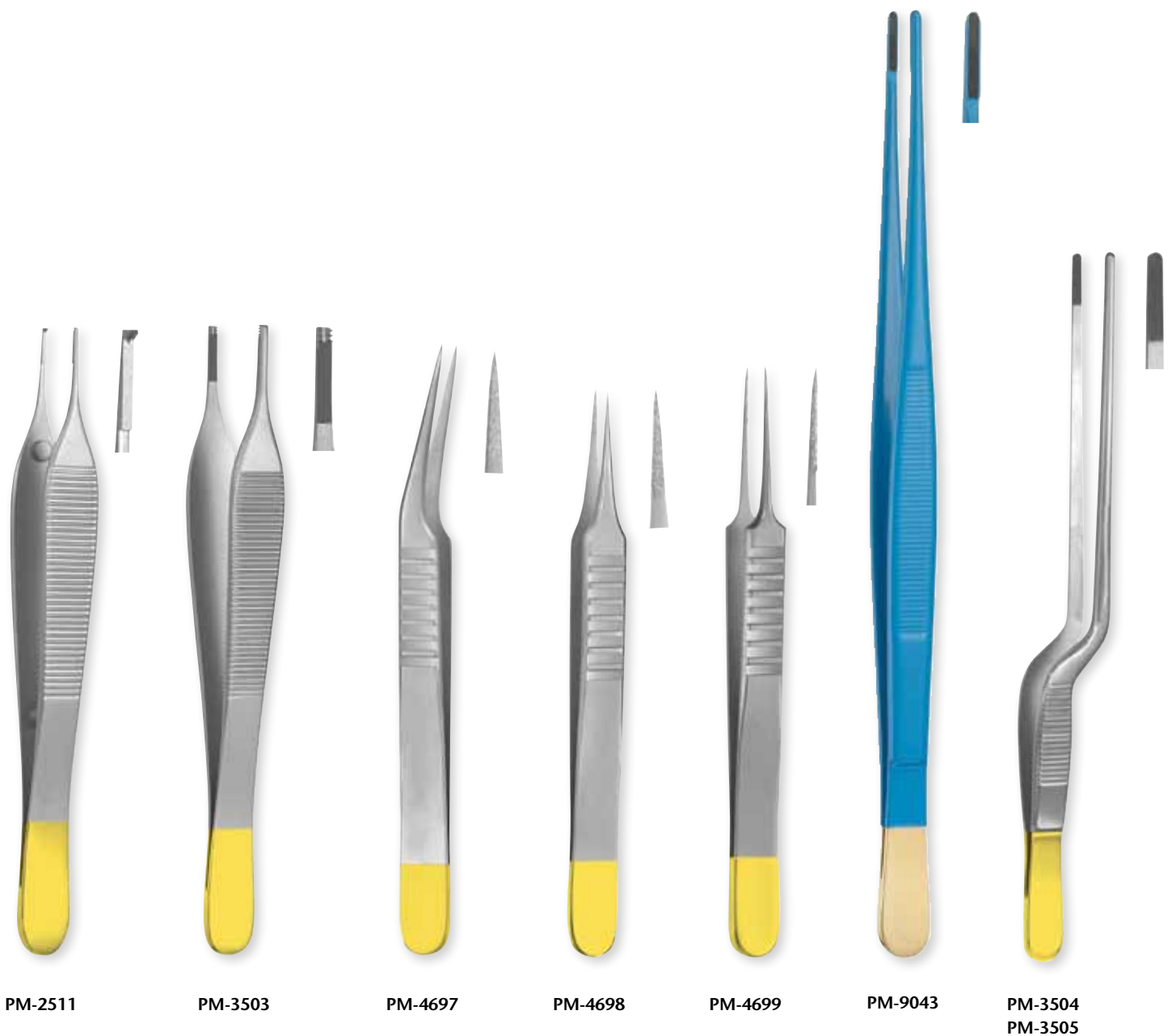

PM-2511

PM-3503

PM-4697

PM-4698

PM-4699

PM-9043

PM-3504
PM-3505

Dressing & Tissue Forceps

Tissue Forceps are designed to hold tissue that is sometimes soft and irregular. These forceps are manufactured with miniature "teeth" that mesh, thereby trapping the tissue and producing a firm grip. This feature has earned these forceps the nickname of "mouse tooth" or "rat tooth."

Dressing Forceps, unlike tissue forceps, have gently serrated tips.

* **Fenestrated handles** are designed as lightweight forceps in order to reduce hand fatigue.

REF	Description	Type	Tip	Length
6-2	Dressing Forceps	standard pattern, serrated handles	serrated tips	4" (10.2 cm)
6-4	Dressing Forceps	standard pattern, serrated handles	serrated tips	4-1/2" (11.4 cm)
6-6	Dressing Forceps	standard pattern, serrated handles	serrated tips	5" (12.7 cm)
6-8	Dressing Forceps	standard pattern, serrated handles	serrated tips	5-1/2" (14 cm)
6-8XL*	Dressing Forceps	fenestrated handle, lightweight	serrated tips	5-1/2" (14 cm)
6-10	Dressing Forceps	standard pattern, serrated handles	serrated tips	6" (15.2 cm)
6-12	Dressing Forceps	standard pattern, serrated handles	serrated tips	7" (17.8 cm)
6-14	Dressing Forceps	standard pattern, serrated handles	serrated tips	8" (20.3 cm)
6-16	Dressing Forceps	standard pattern, serrated handles	serrated tips	10" (25.4 cm)
6-18	Dressing Forceps	standard pattern, serrated handles	serrated tips	12" (30.5 cm)
6-24	Dressing Forceps	delicate pattern, fluted handles	serrated tips	4-1/2" (11.4 cm)
6-26	Dressing Forceps	delicate pattern, fluted handles	serrated tips	5" (12.7 cm)
6-28	Dressing Forceps	delicate pattern, fluted handles	serrated tips	5-1/2" (14 cm)
6-28XL*	Dressing Forceps	fenestrated handle, delicate, lightweight	serrated tips	5-1/2" (14 cm)
6-30	Dressing Forceps	delicate pattern, fluted handles	serrated tips	6" (15.2 cm)
18-779	Eye Dressing Forceps	straight, extra delicate pattern	0.5 mm serrated tips	4" (10.2 cm)
18-780	Eye Dressing Forceps	straight, standard pattern	0.8 mm serrated tips	4" (10.2 cm)
18-781	Eye Dressing Forceps	half curved, extra delicate pattern	0.5 mm serrated tips	4" (10.2 cm)
18-782	Eye Dressing Forceps	half curved, standard pattern	0.8 mm serrated tips	4" (10.2 cm)
18-783	Eye Dressing Forceps	full curved, extra delicate pattern	0.5 mm serrated tips	4" (10.2 cm)
18-784	Eye Dressing Forceps	full curved, standard pattern	0.8 mm serrated tips	4" (10.2 cm)



6-2 to
6-18



6-8XL



6-24 to
6-30



6-28XL



18-780



18-779

18-781
18-782

18-783
18-784

Tissue Forceps

REF	Description	Teeth	Type	Length
6-40	Tissue Forceps	1 x 2	standard pattern, serrated handles	4-1/2" (11.4 cm)
6-42	Tissue Forceps	1 x 2	standard pattern, serrated handles	5" (12.7 cm)
6-44	Tissue Forceps	1 x 2	standard pattern, serrated handles	5-1/2" (14 cm)
6-44XL	Tissue Forceps	1 x 2	standard pattern, lightweight with fenestrated handles	5-1/2" (14 cm)
6-46	Tissue Forceps	1 x 2	standard pattern, serrated handles	6" (15.2 cm)
6-47	Tissue Forceps	1 X 2	standard pattern serrated handles	7" (17.8 cm)
6-48	Tissue Forceps	1 x 2	standard pattern, serrated handles	8" (20.3 cm)
6-50	Tissue Forceps	1 x 2	standard pattern, serrated handles	10" (25.4 cm)
6-52	Tissue Forceps	1 x 2	standard pattern, serrated handles	12" (30.5 cm)
6-90	Tissue Forceps	1 x 2	delicate pattern, fluted handles	4-1/2" (11.4 cm)
6-92	Tissue Forceps	1 x 2	delicate pattern, fluted handles	5" (12.7 cm)
6-94	Tissue Forceps	1 x 2	delicate pattern, fluted handles	5-1/2" (14 cm)
6-96	Tissue Forceps	1 x 2	delicate pattern, fluted handles	6" (15.2 cm)
6-60	Tissue Forceps	2 x 3	standard pattern, serrated handles	4-1/2" (11.4 cm)
6-62	Tissue Forceps	2 x 3	standard pattern, serrated handles	5" (12.7 cm)
6-64	Tissue Forceps	2 x 3	standard pattern, serrated handles	5-1/2" (14 cm)
6-66	Tissue Forceps	2 x 3	standard pattern, serrated handles	6" (15.2 cm)
6-72	Tissue Forceps	3 x 4	standard pattern, serrated handles	5" (12.7 cm)
6-74	Tissue Forceps	3 x 4	standard pattern, serrated handles	5-1/2" (14 cm)
6-76	Tissue Forceps	3 x 4	standard pattern, serrated handles	6" (15.2 cm)
6-82	Tissue Forceps	4 x 5	standard pattern, serrated handles	5" (12.7 cm)
6-84	Tissue Forceps	4 x 5	standard pattern, serrated handles	5-1/2" (14 cm)
6-86	Tissue Forceps	4 x 5	standard pattern, serrated handles	6" (15.2 cm)



6-40 to 6-52

6-44XL

6-90 to 6-96

6-60 to 6-66

6-72 to 6-76

6-82 to 6-86

Iris Tissue Forceps

REF	Description	Teeth	Type	Tips	Length
18-785	Iris Tissue Forceps	1 x 2	straight, extra delicate	0.5 mm wide	4" (10.2 cm)
18-789	Iris Tissue Forceps	1 x 2	half curved, extra delicate	0.5 mm wide	4" (10.2 cm)
18-791	Iris Tissue Forceps	1 x 2	full curved, extra delicate	0.5 mm wide	4" (10.2 cm)
18-786	Iris Tissue Forceps	1 x 2	straight, standard	0.8 mm wide	4" (10.2 cm)
18-787	Iris Tissue Forceps	1 x 2	straight, standard, non-magnetic	0.8 mm wide	4" (10.2 cm)
18-788	Iris Tissue Forceps	1 x 2	half curved, standard	0.8 mm wide	4" (10.2 cm)
18-790	Iris Tissue Forceps	1 x 2	full curved, standard	0.8 mm wide	4" (10.2 cm)



18-785



18-789



18-791

18-786
18-787

18-788



18-790

Dressing & Tissue Forceps

REF	Description	Teeth	Type	Length
6-100	Dressing Forceps	-	serrated, curved narrow tips	5" (12.7 cm)
6-104	SEMKEN Dressing Forceps	-	serrated, straight	5" (12.7 cm)
6-106	SEMKEN Tissue Forceps	1 x 2	straight	5" (12.7 cm)
6-107	SEMKEN Tissue Forceps	1 x 2	curved tips	5" (12.7 cm)
6-108	SEMKEN Tissue Forceps	2 x 3	straight	5" (12.7 cm)
6-109	SEMKEN Dressing Forceps	-	serrated, straight	6" (15.2 cm)
6-109A	SEMKEN Tissue Forceps	1 x 2	straight	6" (15.2 cm)



6-100



6-104



6-106



6-107

6-108



6-109A

6-109

Dressing & Tissue Forceps

REF	Description	Teeth	Type	Length
6-110	STILLE pattern Tissue Forceps	4 x 5	-	5" (12.7 cm)
6-112	HUDSON (EWALD) Dressing Forceps	-	serrated	4-3/4" (12.1 cm)
6-114	HUDSON (EWALD) Tissue Forceps	1 x 2	-	4-3/4" (12.1 cm)
6-118	ADSON Dressing Forceps	-	delicate, serrated	4-3/4" (12.1 cm)
6-118A	ADSON Dressing Forceps	-	delicate, serrated, angled	4-3/4" (12.1 cm)
6-118XL	ADSON Dressing Forceps	-	delicate, fenestrated handles, lightweight	4-3/4" (12.1 cm)
17-2510	Micro ADSON Dressing Forceps	-	serrated, 0.5 mm wide	4-3/4" (12.1 cm)



6-110



6-112



6-114



6-118A



6-118XL



17-2510

Dressing & Tissue Forceps

REF	Description	Teeth	Type	Length
6-120	ADSON Tissue Forceps	1 x 2	delicate	4-3/4" (12.1 cm)
6-120A	ADSON Tissue Forceps	1 x 2	delicate, angled tip	4-3/4" (12.1 cm)
6-120XL	ADSON Tissue Forceps	1 x 2	lightweight fenestrated handles	4-3/4" (12.1 cm)
6-123XL	ADSON Dressing/Tissue Suture Forceps	1 x 2	with tying platform, fenestrated handles	4-3/4" (12.1 cm)
6-124XL	BROWN-ADSON Tissue Forceps	7 x 7	side grasping teeth, fenestrated handles	4-3/4" (12.1 cm)
6-121	ADSON Tissue Forceps	1 x 2	delicate, cross serrated tips	4-3/4" (12.1 cm)
6-122	ADSON Tissue Forceps	2 x 3	delicate	4-3/4" (12.1 cm)
6-123	ADSON Dressing/Tissue Suture Forceps	1 x 2	with tying platform	4-3/4" (12.1 cm)
6-124	BROWN-ADSON Tissue Forceps	7 x 7	side grasping teeth	4-3/4" (12.1 cm)



Dressing & Tissue Forceps

Ref	Description	Teeth	Type	Length
6-125	DeBAKEY-ADSON Dressing Forceps	-	atraumatic tips 1.5 mm wide	4-3/4" (12.1 cm)
6-126	BROWN-ADSON Tissue Forceps	7 x 7	angular	4-3/4" (12.1 cm)
6-128	HEANEY Tissue Forceps	2 x 3	cross-serrated tips	5-1/2" (14 cm)
6-132	STONE Tissue Forceps	4 x 5	-	6" (15.2 cm)
6-134	MARTIN Tissue Forceps	7 x 8	-	6" (15.2 cm)
6-136	MARTIN Tissue Forceps	7 x 8	-	7-1/2" (19.1 cm)



Dressing & Tissue Forceps

REF	Description	Teeth	Type	Length
6-138	BROWN Tissue Forceps	8 x 8	side grasping teeth	6" (15.2 cm)
6-140	BROWN Tissue Forceps	8 x 8	side grasping teeth	8" (20.3 cm)
6-141	BROWN Tissue Forceps	8 x 8	side grasping teeth	10" (25.4 cm)
6-142	RUSSIAN Tissue Forceps	-	-	6" (15.2 cm)
6-144	RUSSIAN Tissue Forceps	-	-	8" (20.3 cm)
6-145	RUSSIAN Tissue Forceps	-	-	10" (25.4 cm)
6-148	BONNEY Tissue Forceps	1 x 2	serrated tips	7" (17.8 cm)
6-150	BONNEY Tissue Forceps	2 x 3	serrated tips	7" (17.8 cm)
6-154	POTTS-SMITH Dressing Forceps	-	serrated tips	7" (17.8 cm)
6-156	POTTS-SMITH Dressing Forceps	-	serrated tips	8-1/4" (21 cm)
6-158	POTTS-SMITH Dressing Forceps	-	serrated tips	9-1/2" (24.1 cm)
6-159	POTTS-SMITH Dressing Forceps	-	serrated tips	12" (30.5 cm)
6-160	POTTS-SMITH Tissue Forceps	1 x 2	serrated tips	7" (17.8 cm)
6-162	POTTS-SMITH Tissue Forceps	1 x 2	serrated tips	8-1/4" (21 cm)
6-164	POTTS-SMITH Tissue Forceps	1 x 2	serrated tips	9-1/2" (24.1 cm)
6-164A	POTTS-SMITH Tissue Forceps	1 x 2	serrated tips	12" (30.5 cm)



6-138
6-140
6-141



6-142
6-144
6-145



6-148



6-150



6-160 to
6-164A

6-154
6-156
6-158
6-159

Dressing & Tissue Forceps

REF	Description	Teeth	Type	Length
6-166	CUSHING Dressing Forceps	-	serrated, Gutch handle, scraper end	7" (17.8 cm)
6-168	CUSHING Tissue Forceps	1 x 2	Gutch handle, scraper end	7" (17.8 cm)
6-180	GERALD Dressing Forceps	-	straight, serrated	7" (17.8 cm)
6-182	GERALD Tissue Forceps	1 x 2	straight	7" (17.8 cm)
6-184	GERALD Dressing Forceps	-	curved, serrated	7" (17.8 cm)
6-186	GERALD Tissue Forceps	1 x 2	curved	7" (17.8 cm)
6-188	CUSHING Dressing Forceps	-	serrated, scraper end	7" (17.8 cm)
6-189	CUSHING Tissue Forceps	1 x 2	scraper end	7" (17.8 cm)



6-168

6-166

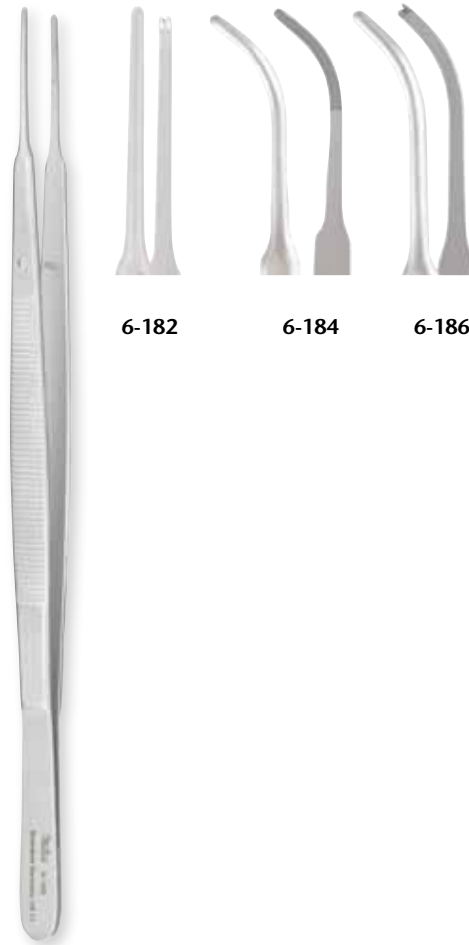

6-182

6-184

6-186

6-189

6-180

6-188

Dressing & Tissue Forceps

REF	Description	Teeth	Type	Length
6-190	CUSHING Dressing Forceps	-	serrated, bayonet, scraper end	7-1/4" (18.4 cm)
6-192	CUSHING Tissue Forceps	1 x 2	bayonet, scraper end	7-1/4" (18.4 cm)
6-197	GRUENWALD (JANSEN) Bayonet Dressing Forceps	-	serrated	6-1/2" (16.5 cm)
6-198	ADSON Bayonet Dressing Forceps	-	-	8-1/4" (21 cm)
6-200	KELLY Tissue Forceps	1 x 2	slotted Gutch handles	9-3/4" (24.8 cm)
6-202	KELLY Tissue Forceps	2 x 3	slotted Gutch handles	9-3/4" (24.8 cm)
6-204	KELLY Tissue Forceps	3 x 4	slotted Gutch handles	9-3/4" (24.8 cm)
6-210	MAYO RUSSIAN Tissue Forceps	-	fenestrated jaws, slotted grooved handles	9" (22.9 cm)

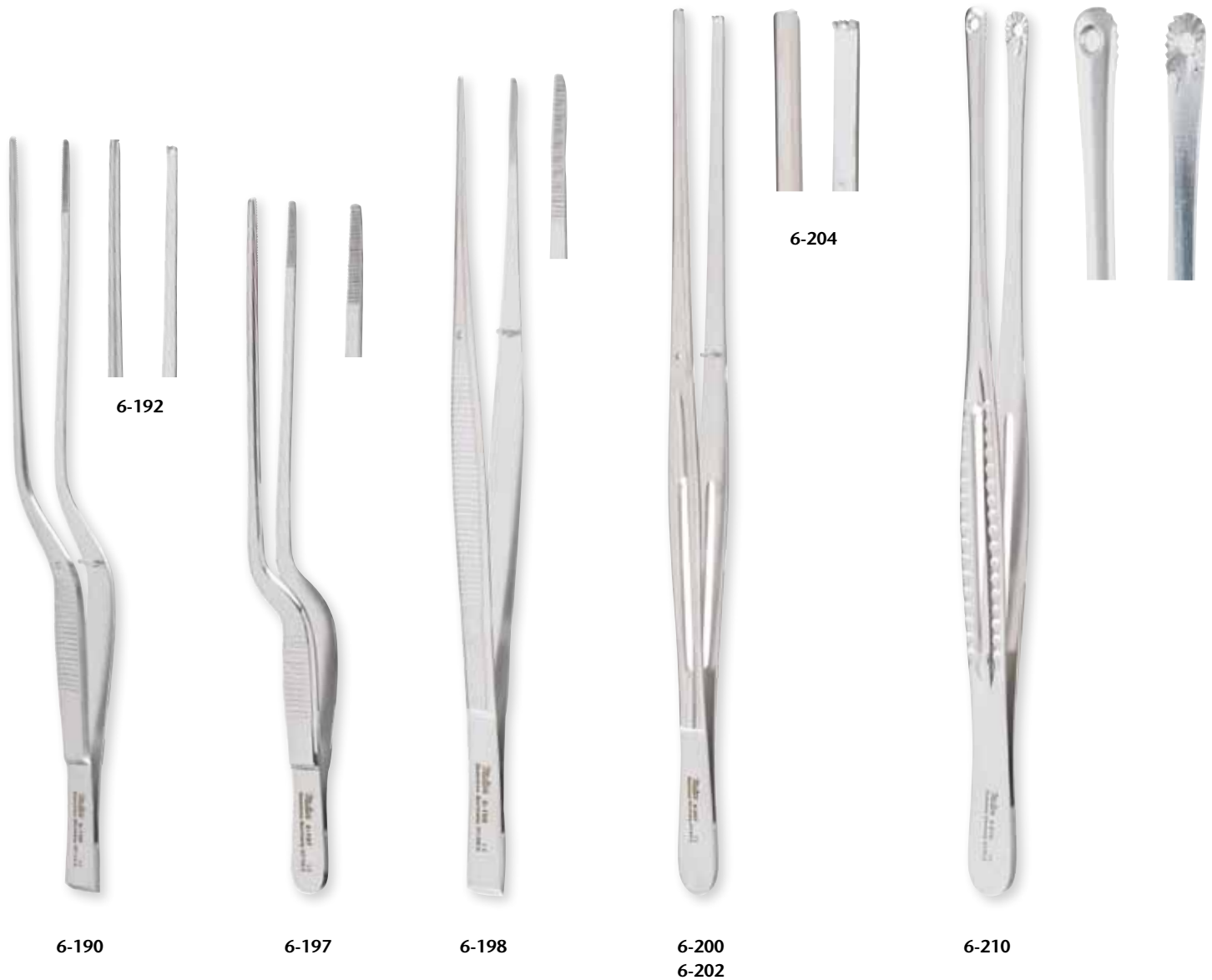

Dressing & Tissue Forceps

REF	Description	Type	Length
6-212	DAVIS Tissue Forceps	-	10" (25.4 cm)
6-214	SINGLEY Tissue Forceps	fenestrated serrated jaws	9" (22.9 cm)
16-80	WANGENSTEEN Tissue Forceps	rounded jaws with fine cross-serrations	9" (22.9 cm)
17-1100	RHOTON Micro Suture Forceps	straight, with 0.7 mm tying platform	7" (17.8 cm)
17-1150	RHOTON Micro Forceps	straight, 0.3 mm tips	7" (17.8 cm)

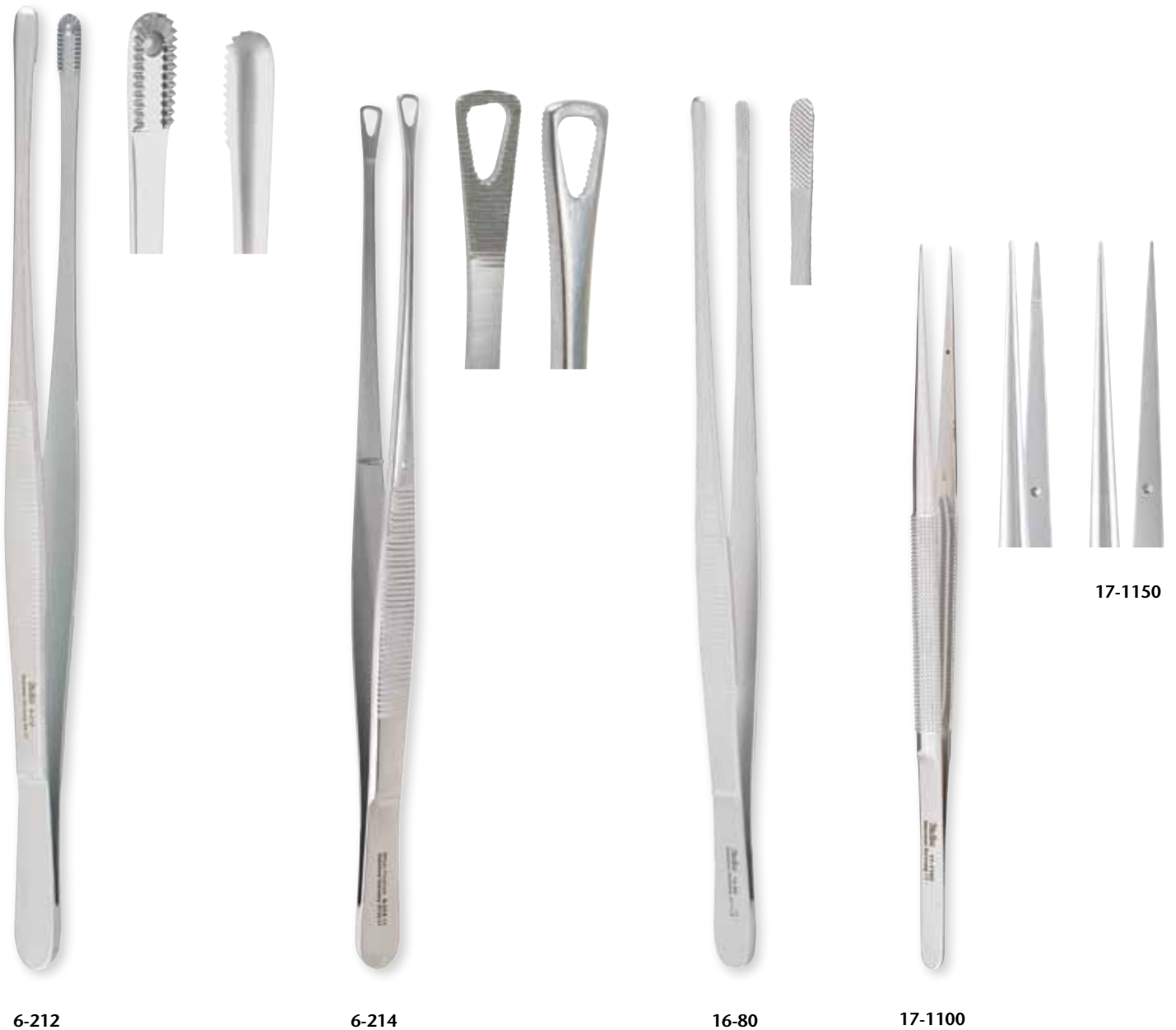

Dressing & Tissue Forceps

REF	Description	Teeth	Type	Length
18-620	KIRBY Iris Forceps	1 x 2	straight	4" (10.2 cm)
18-624	KIRBY Iris Forceps	1 x 2	curved	4" (10.2 cm)
18-632	KIRBY Cornea-Scleral Forceps	1 x 2	angled tips	4" (10.2 cm)
18-793	O'CONNOR Iris Forceps	1 x 2	angular jaws, 0.5 x 9 mm	3-3/4" (9.5 cm)
18-794	BRACKEN Iris Forceps	-	with fine cross-serrated tips	4" (10.2 cm)
18-795	FOERSTER Eye Dressing Forceps	-	octagonal grip, straight, serrated tips 0.5 mm wide	3-3/4" (9.5 cm)
18-795A	FOERSTER Eye Dressing Forceps	-	octagonal grip, full curved, serrated tips 0.5 mm wide	3-3/4" (9.5 cm)
18-796	FOERSTER Iris Tissue Forceps	1 x 2	octagonal grip, straight, 0.5 mm wide	3-3/4" (9.5 cm)
18-798	FOERSTER Iris Tissue Forceps	1 x 2	octagonal grip, full curved, 0.5 mm wide	3-3/4" (9.5 cm)
18-804	STEVENS Iris Forceps	1 x 2	straight, 1 mm wide	4" (10.2 cm)

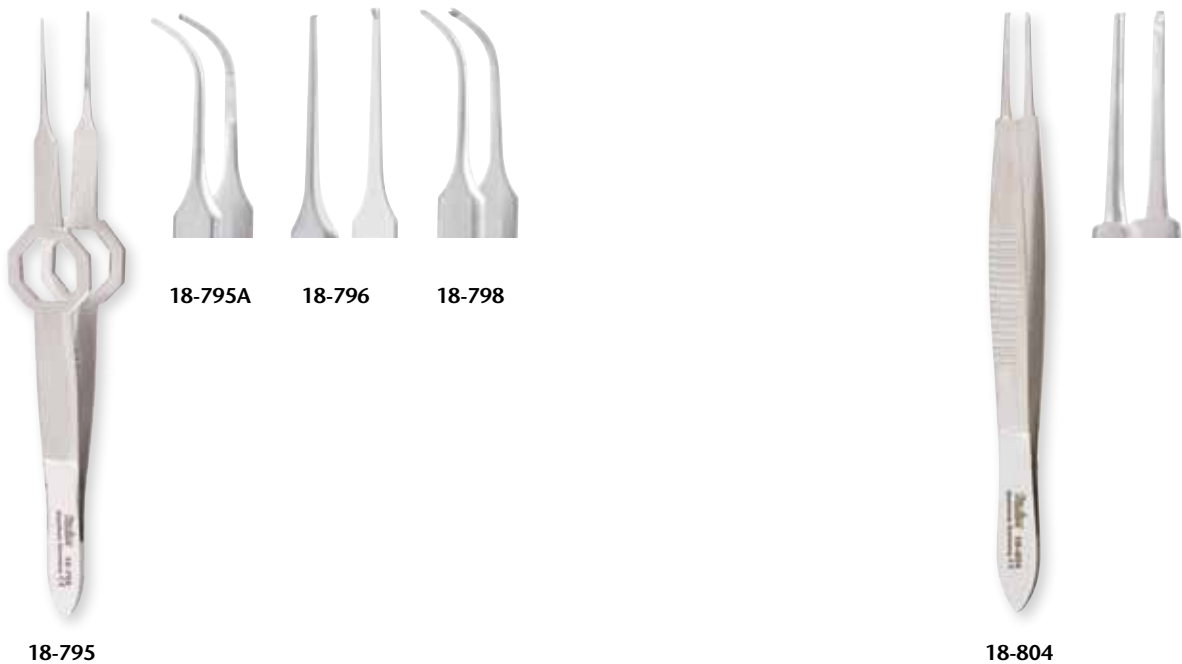

Dressing & Tissue Forceps

REF	Description	Teeth	Type	Length
18-814	GRAEFE Eye Dressing Forceps	-	straight, serrated	2-3/4" (7 cm)
18-816	GRAEFE Iris Forceps	1 x 2	straight	2-3/4" (7 cm)
18-818	GRAEFE Eye Dressing Forceps	-	curved, serrated	2-3/4" (7 cm)
18-820	GRAEFE Iris Forceps	1 x 2	curved	2-3/4" (7 cm)
18-825	GILL (Chandler) Iris Forceps	-	fine cross-serrated tips, 0.6 mm wide	3" (7.6 cm)
18-827	TROUTMAN-BARRAQUER Colibri Type Corneal Utility Forceps	1 x 2	0.4 mm, set at 45° angle, with tying platform	3" (7 cm)
18-828	TROUTMAN-BARRAQUER Colibri Type Corneal Utility Forceps	1 x 2	0.12 mm, set at 45° angle, with tying platform	3" (7 cm)
18-829	BOTVIN Iris Forceps	-	fine cross-serrated tips, 0.5 mm wide	2-7/8" (7.3 cm)
18-830	GILL-HESS Iris Forceps	1 x 2	forward tips 0.5 mm wide	2-3/4" (7 cm)
18-834	GILL Iris Forceps	1 x 2	tips 0.6 mm wide	2-7/8" (7.3 cm)
18-835	BONN Micro Suturing Forceps	1 x 2	0.12 mm, with tying platform	2-3/4" (7 cm)

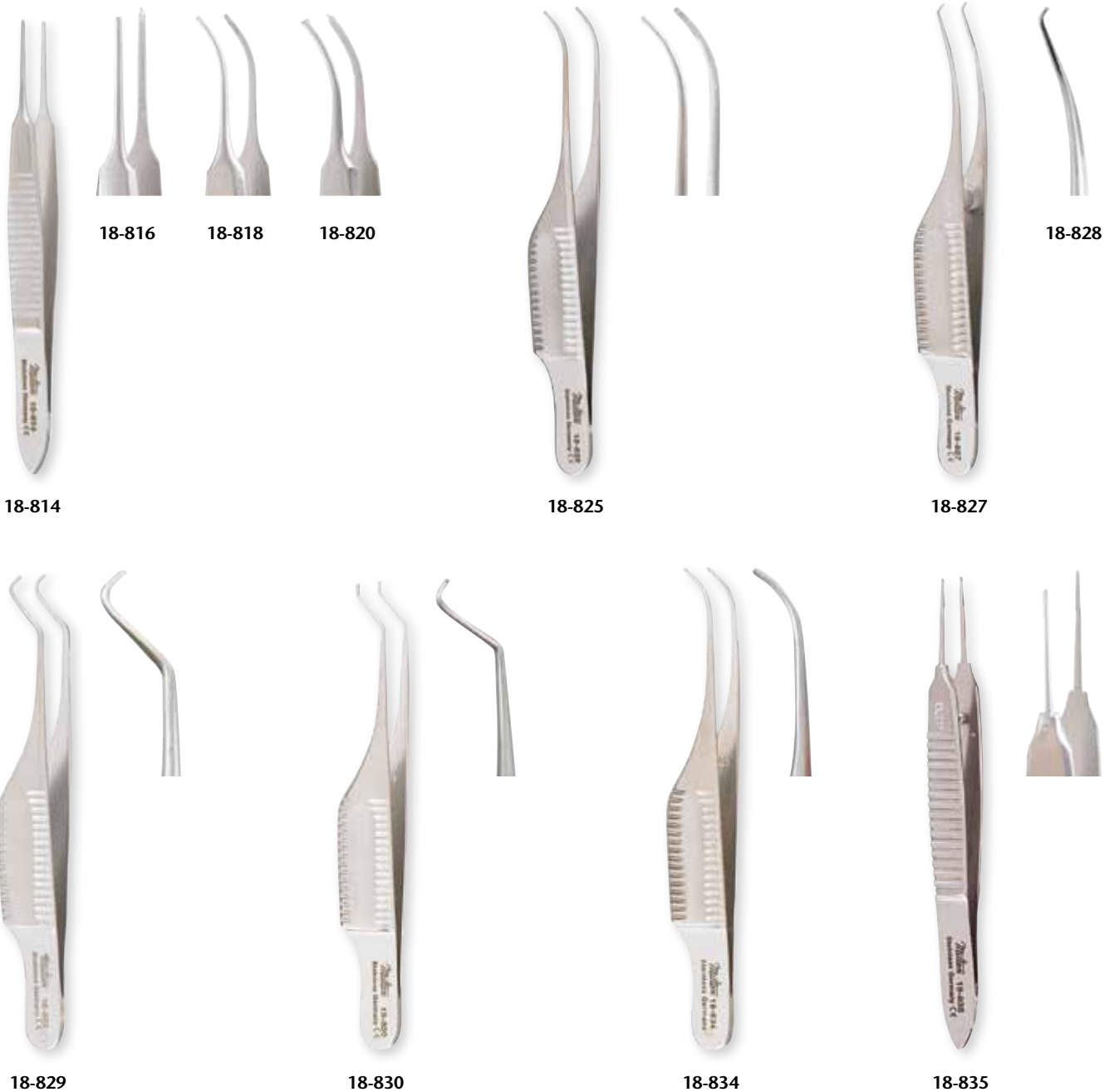

Dressing & Tissue Forceps

REF	Description	Teeth	Type	Length
18-836	BONN Micro Suturing Forceps	1 x 2	0.12 mm, with tying platform	3-3/4" (9.5 cm)
18-837	McPHERSON Micro Corneal Suturing Forceps	1 x 2	straight, 0.2 mm, with tying platform	3-1/2" (8.9 cm)
18-838	McPHERSON Micro Corneal Suturing Forceps	1 x 2	angled, 0.2 mm, with tying platform	3-1/2" (8.9 cm)
18-840	Strabismus Tissue Forceps	1 x 2	1 mm wide tips	4" (10.2 cm)
18-850	GRAEFE Fixation Forceps	-	fine standard jaws 4.5 mm wide	4-3/8" (11.2 cm)
18-852	GRAEFE Fixation Forceps	-	fine standard jaws 4.5 mm wide, non-magnetic	4-3/8" (11.2 cm)
18-854	GRAEFE Fixation Forceps	-	fine standard jaws 4.5 mm wide, with catch	4-3/8" (11.2 cm)
18-860	WALDEAU Fixation Forceps	-	fine concave jaws 5 mm wide	4-3/8" (11.2 cm)
18-866	BISHOP-HARMON Dressing Forceps	-	fine cross serrated tips 0.5 mm wide	3-3/8" (8.6 cm)
18-867	BISHOP-HARMON Micro Tissue Forceps	1 x 2	delicate 0.3 mm tips	3-3/8" (8.6 cm)
18-868	BISHOP-HARMON Tissue Forceps	1 x 2	standard 0.7 mm tips	3-3/8" (8.6 cm)



18-836



18-837



18-840

18-838



18-850 to
18-854



18-860



18-866

18-867

18-868

Dressing & Tissue Forceps

REF	Description	Teeth	Type	Length
18-880	PIERSE Colibri Type Corneal Forceps	-	tips 0.12 mm	3-1/4" (8.3 cm)
18-881	PIERSE Colibri Type Corneal Forceps	-	tips 0.3 mm	3-1/4" (8.3 cm)
18-883	CASTROVIEJO Colibri Type Corneal Forceps	-	tips 0.12 mm, with tying platform	4" (10.2 cm)
18-896	GREEN Fixation Forceps	19 x 20	T-Shape, 12 mm jaws	4" (10.2 cm)
18-897	GREEN Fixation Forceps	8 x 9	T-Shape, 5 mm jaws	4" (10.2 cm)
18-904	O'BRIEN Fixation Forceps	1 x 2	delicate, 0.9 mm wide, angled forward	4" (10.2 cm)
18-906	ELSCHNIG Fixation Forceps	1 x 2	strong, 0.9 mm wide, angled upward	4-1/4" (10.8 cm)
18-912	LESTER Fixation Forceps	1 x 2	delicate, 0.6 mm wide	3-3/4" (9.5 cm)
18-914	LESTER Fixation Forceps	2 x 3	delicate, 1 mm wide	3-3/4" (9.5 cm)



18-881

18-880



18-883

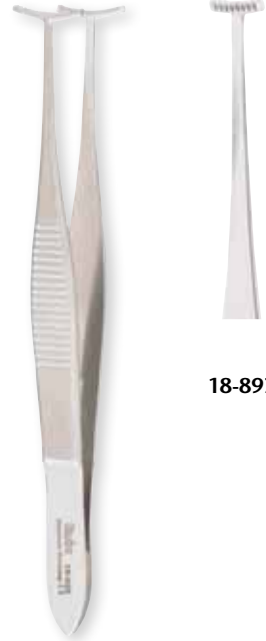

18-897

18-896



18-904



18-906



18-912



18-914

Dressing & Tissue Forceps

REF	Description	Teeth	Type	Length
18-916	HARMON Fixation Forceps	4 x 5	delicate 2.5 mm wide tips	3" (7.6 cm)
18-946	HARMS Suturing Forceps	-	straight, 11 mm wide handles, tying platform, 0.6 mm wide tip	4-1/8" (10.5 cm)
18-947	HARMS Suturing Forceps	-	curved, 11 mm wide handles, tying platform, 0.6 mm wide tip	4-1/8" (10.5 cm)
18-948	McPHERSON Micro Iris Suturing Forceps	-	straight, smooth platform 0.3 mm x 5 mm	3-1/2" (8.9 cm)
18-949	McPHERSON Micro Iris Suturing Forceps	-	angled, smooth platform 0.3 x 5 mm	3-1/2" (8.9 cm)
18-950	CASTROVIEJO Suturing Forceps	1 X 2	0.9 mm, with tying platform	4" (10.2 cm)
18-951	CASTROVIEJO Suturing Forceps	1 X 2	0.3 mm, with tying platform	4" (10.2 cm)
18-952	CASTROVIEJO Suturing Forceps	1 X 2	0.6 mm, with tying platform	4" (10.2 cm)
18-953	CASTROVIEJO Micro Suturing Forceps	1 X 2	11 mm wide handles, 0.12 mm, with tying platform	4-1/4" (10.8 cm)
18-954	CASTROVIEJO Suturing Forceps	1 X 2	11 mm wide handles, 0.6 mm, with tying platform	4-1/4" (10.8 cm)
18-955	CASTROVIEJO Suturing Forceps	1 X 2	11 mm wide handles, 0.9 mm, with tying platform	4-1/4" (10.8 cm)
18-956	NUGENT Utility Forceps	-	smooth tips, 1.2 mm wide	4-1/4" (10.8 cm)
18-958	NUGENT Utility Forceps	-	cross-serrated tips, 1.2 mm wide	4-1/4" (10.8 cm)



18-916



18-947

18-946



18-949

18-948



18-950 to
18-952



18-953 to
18-955



18-958

18-956

Dressing & Tissue Forceps

REF	Description	Teeth	Type	Length
18-962	McCULLOUGH Utility Forceps	-	smooth tips, 1.5 mm wide	4" (10.2 cm)
18-964	McCULLOUGH Utility Forceps	-	cross-serrated tips, 1.5 mm wide	4" (10.2 cm)
18-966	McCULLOUGH Suturing Forceps	1 x 2	cross-serrated jaws, 1.5 mm wide	4" (10.2 cm)
18-970	WILLS HOSPITAL Utility Forceps	-	cross-serrated tying platform, 1.2 mm wide	4" (10.2 cm)
18-971	BONNACOLTS Utility Forceps	-	longitudinal serrations with cross-serrations on tip, 1.2 mm wide with tapered tips	4" (10.2 cm)
18-974	SAUER Suturing Forceps	1 x 2	curved teeth overlapping, 0.6 mm wide	3-1/2" (8.9 cm)
18-975	MANHATTAN EYE & EAR Suturing Forceps	1 x 2	smooth platform, teeth overlapping, 0.7 mm wide	3-1/2" (8.9 cm)
18-978	SCHAAF Foreign Forceps	-	grooved tips	3-3/4" (9.5 cm)
18-1100	LITTAUER Cilia Forceps	-	4 mm wide jaws with fine horizontal serrations	3-1/2" (8.9 cm)
18-1102	BEER Cilia Forceps	-	4 mm wide smooth jaws	3-1/2" (8.9 cm)
18-1104	ZIEGLER Cilia Forceps	-	2 mm wide serrated jaws, serrated	3-1/2" (8.9 cm)



18-964 18-966

18-962



18-970

18-971



18-974



18-975



18-978

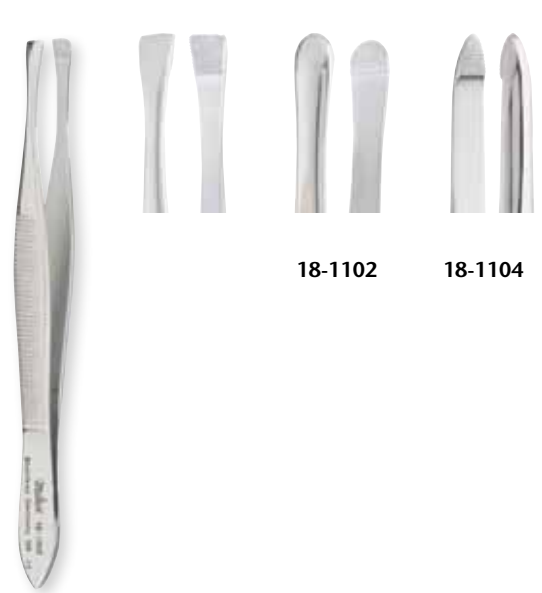

18-1102

18-1104

18-1100

Dressing & Tissue Forceps

REF	Description	Type	Length
18-1106	DOUGLAS Cilia Forceps	thin tips, 2.5 mm wide, with fine horizontal serrations	3-1/2" (8.9 cm)
18-1107	SWISS Cilia and Suture Forceps	3 mm wide precision fitted diagonal jaws	3-3/4" (9.5 cm)
18-1110	BERGH Cilia Forceps	5 mm wide jaws with horizontal serrations	3-1/2" (8.9 cm)
18-1111	BARRAQUER Cilia Suture Forceps	5 mm smooth platform	4-1/2" (11.4 cm)
18-1112	BENNETT Cilia Forceps	cup shaped jaws, 3 mm diameter	3" (7.6 cm)
18-1114	BEAUPRE Cilia Forceps	smooth jaws, 12 mm long, 45° angle	4-1/2" (11.4 cm)
18-1116	GRADLE Cilia Forceps	precision ground jaws, 1.4 mm wide	4" (10.2 cm)



18-1106



18-1107



18-1110



18-1111



18-1112



18-1114



18-1116

Dressing & Tissue Forceps

REF	Description	Type	Length
19-350	WILDE Ear Forceps	angular with serrated tips	5" (12.7 cm)
19-356	WILDE Ear Forceps	cross-action, angular with serrated tips	4-3/4" (12.1 cm)
19-360	BLAKE Ear Forceps	very delicate, angular with serrated tips	4-1/8" (10.5 cm)
20-120	WILDE Dressing Forceps	angular, serrated tips	6-1/2" (16.5 cm)
19-370	LUCAE Ear Forceps	bayonet shape, serrated tips	5-1/2" (14 cm)
19-371	JANSEN Ear Forceps	bayonet shape, very delicate with 2 mm wide serrated tips	6-1/4" (15.9 cm)



19-350
19-356

19-360

20-120

19-370

19-371

Dressing & Tissue Forceps

DeBakey and Cooley Forceps feature atraumatic jaws.

REF	Description	Teeth	Type	Length
24-550	DeBAKEY Thoracic Tissue Forceps	-	2.5 mm wide jaws	6" (15.2 cm)
24-552	DeBAKEY Thoracic Tissue Forceps	-	2.5 mm wide jaws	7-1/2" (19.7 cm)
24-554	DeBAKEY Thoracic Tissue Forceps	-	2.5 mm wide jaws	9-1/2" (24.1 cm)
24-556	DeBAKEY Thoracic Tissue Forceps	-	2.5 mm wide jaw	12" (30.5 cm)
24-570	DeBAKEY Vascular Tissue Forceps	-	1.5 mm wide jaws	6" (15.2 cm)
24-572	DeBAKEY Vascular Tissue Forceps	-	1.5 mm wide jaws	8" (20.3 cm)
24-574	DeBAKEY Vascular Tissue Forceps	-	1.5 mm wide jaws	9-1/2" (24.1 cm)
24-570XL	DeBAKEY Tissue Forceps	-	lightweight, 1.5 mm jaws, fenestrated handles	6" (15.2 cm)
24-580	COOLEY Vascular Tissue Forceps	-	2 mm tips	6" (15.2 cm)
24-582	COOLEY Vascular Tissue Forceps	-	2 mm tips	8" (20.3 cm)
26-956	FERRIS-SMITH Tissue Forceps	1 x 2	serrated platform tips	7" (17.8 cm)
26-958	FERRIS-SMITH Tissue Forceps	2 x 3	serrated platform tips	7" (17.8 cm)
33-500	MILTEX Depilatory Forceps	-	flat square tips with deep serrations	5-1/2" (14 cm)



24-550 to
24-556



24-570 to
24-574



24-570XL



24-580
24-582



26-956



33-500

Splinter Forceps

REF	Description	Type	Length
6-300	Plain Splinter Forceps	straight	3-1/2" (8.9 cm)
6-302	Plain Splinter Forceps	straight	4" (10.2 cm)
6-304	Plain Splinter Forceps	straight	4-1/2" (11.4 cm)
6-308	CARMALT Splinter Forceps	straight	4-1/4" (10.8 cm)
6-310	CARMALT Splinter Forceps	curved	4-1/4" (10.8 cm)
6-312	WALTER Splinter Forceps	straight	4-1/4" (10.8 cm)
6-314	WALTER Splinter Forceps	curved	4-1/4" (10.8 cm)
6-316	FEILCHENFELD Splinter Forceps	straight	3" (7.6 cm)
6-318	FEILCHENFELD Splinter Forceps	straight	4-1/2" (11.4 cm)



6-300 to
6-304



6-308



6-312



6-316

6-318

Splinter Forceps

REF	Description	Type	Length
6-330	Physicians' Splinter Forceps	straight	5" (12.7 cm)
6-336	VIRTUS Splinter Forceps	straight	6" (15.2 cm)
6-337	VIRTUS Splinter Forceps	45° angle	5-1/2" (14 cm)
6-338	WILLIAMS Splinter Forceps	straight	5-1/2" (14 cm)
6-340	WILLIAMS Splinter Forceps	45° angle	5-1/2" (14 cm)
6-342	WILLIAMS Splinter Forceps	right angle	4-3/4" (121mm)
6-350	PEET Splinter Forceps	double curve	4-3/4" (12.1 cm)
6-400	MILTEX Splinter Liberator	trocarn point in reversible handle	5" (12.7 cm)



6-330



6-336



6-337



6-338



6-340



6-342



6-350



6-400

Splinter Forceps

Professional Splinter Removal Kit includes the Splinter Liberator used to approach the embedded fragment by elevating the epidermis.

After the fragment is exposed, the Walter Forceps are used for quick and easy removal of splinter.

REF	Description	Type	Length
V96-329	Splinter Forceps	with magnifier, in black plastic case	3" (7.6 cm)
V96-336	Virtus Splinter Forceps	-	6" (15.2 cm)
V96-312	Walter Splinter Forceps	straight	4-1/2" (11.4 cm)
V96-400	Splinter Liberator	in reversible handle, with needle sharp tips	5" (12.7 cm)
V96-410	Professional Splinter Removal Kit	Splinter Liberator & Forceps for removal	-



V96-329



V96-336



V96-312



V96-400



V96-312
V96-400
V96-410

Microsurgical Forceps

REF	Description	Type	Style	Length
17-301	SWISS Jeweler Style Forceps	non-magnetic stainless steel	1, fine	4-3/4" (12.1 cm)
17-302	SWISS Jeweler Style Forceps	non-magnetic stainless steel	2, strong, fine	4-3/4" (12.1 cm)
17-303	SWISS Jeweler Style Forceps	non-magnetic stainless steel	3, narrow, fine	4-3/4" (12.1 cm)
17-303C	SWISS Jeweler Style Forceps	non-magnetic stainless steel	3C, narrow, fine	4-3/8" (11.2 cm)
17-303X	SWISS Jeweler Style Forceps	non-magnetic stainless steel	3, micro-fine	4-3/4" (12.1 cm)
17-304	SWISS Jeweler Style Forceps	non-magnetic stainless steel	4, fine	4-3/8" (11.2 cm)



17-301

17-302

17-303

17-303C

17-303X

17-304

Microsurgical Forceps

REF	Description	Type	Style	Length
17-305	SWISS Jeweler Style Forceps	non-magnetic stainless steel	5, super fine	4-3/8" (11.2 cm)
17-305X	SWISS Jeweler Style Forceps	non-magnetic stainless steel	5, micro-fine	4-3/8" (11.2 cm)
17-306	SWISS Jeweler Style Forceps	non-magnetic stainless steel	6, pickup	4-1/2" (11.4 cm)
17-307	SWISS Jeweler Style Forceps	non-magnetic stainless steel	7, fine, curved	4-1/2" (11.4 cm)
17-307X	SWISS Jeweler Style Forceps	non-magnetic stainless steel	7, micro-fine, curved	4-1/2" (11.4 cm)
18-980	THORPE Corneal and Splinter Forceps	very sharp points, fine serrated tips	-	4-1/2" (11.4 cm)



17-305



17-305X



17-306



17-307



17-307X



18-980

Hemostats are used in a variety of ways, but the primary function is to control or stop the flow of blood through arteries and veins. The diagram below illustrates the important aspects in the construction of a hemostat.

ANATOMY OF MILTEX® HEMOSTATIC FORCEPS



TIPS

The tips should meet first when closing the instrument and the space between the jaws should gradually diminish as the hemostat is being fully closed.

BOX LOCK

The box lock has a smoothly beveled surface to minimize the chance of the instrument catching or snagging other material during surgery.

SHANK

It is essential that the shank be sufficiently flexible so the surgeon develops a certain amount of “feel” with the instrument, thereby improving control.

RATCHET

Ratchets should engage as the tips meet and should operate smoothly as the hemostat is closed. The ratchet should lock securely yet still permit easy release.

RING HANDLES

Well rounded and polished handles provide a more comfortable grip.

HEMOSTATIC FORCEPS A Construction & Functional Guide

Name	Construction and Functional Description	Nickname
HALSTED	7-2 through 7-20	Mosquito Clamp
	Serrations are full horizontal	
	Straight and curved	
	Length 5" (12.7 cm)	
HARTMAN	7-24 through 7-26	Mosquito Clamp/Baby Mosquito
	Serrations are full horizontal	
	Straight and curved	
	Length 3-1/2" (8.9 cm)	
PROVIDENCE HOSPITAL	7-30 through 7-32	Delicate Kelly Clamp
	Serrations are partial horizontal	
	Straight and curved	
	Length 5-1/2" (14 cm)	
KELLY	7-36 through 7-38	Kelly Clamp
	Serrations are partial horizontal	
	Straight and curved	
	Length 5-1/2" (14 cm)	
CRILE	7-42 through 7-52	Crile Clamp
	Serrations are full horizontal	
	Straight and curved	
	Length 5-1/2" (14 cm) or 6-1/4" (15.9 cm)	
KOCHER	7-66 through 7-68	Kocher Clamp
	Serrations are full horizontal	
	Straight and curved, tips are 1 x 2 teeth	
	Length 5-1/2" (14 cm)	
RANKIN	7-92 through 7-94	Rankin-Kelly Clamp
	Serrations are partial horizontal	
	Straight and curved	
	Length 6-1/4" (15.9 cm)	
ROCHESTER-PEAN	7-118 through 7-148	Pean-Mayo/Mayo-Pean Clamp
	Serrations are full horizontal	
	Straight and curved (used to hold tissue flaps)	
	Length 5-1/2" (14 cm) - 12" (30.5 cm)	
ROCHESTER-OCHSNER	7-150 through 7-167	Ochsner Mayo-Ochsner Clamp
	Serrations are full horizontal	
	Straight and curved, tips are 1 x 2 teeth (used to hold tissue & bone)	
	Length 6-1/4" (15.9 cm) - 10" (25.4 cm)	
ROCHESTER-CARMALT	7-170 through 7-182	Carmalt-Mayo/Carmalt Clamp
	Serrations are longitudinal	
	Straight and curved (used to hold or crush sections of tissue)	
	Length 6-1/4" (15.9 cm) or 8" (20.3 cm)	

Hemostatic Forceps, Mosquito

REF	Description	Type	Length
7-2	HALSTED Mosquito Forceps	straight	5" (12.7 cm)
7-4	HALSTED Mosquito Forceps	curved	5" (12.7 cm)
18-1934	HALSTED Mosquito Forceps	straight, non-magnetic	5" (12.7 cm)
18-1936	HALSTED Mosquito Forceps	curved, non-magnetic	5" (12.7 cm)
7-8	HALSTED Mosquito Forceps	straight, extra delicate	5" (12.7 cm)
7-10	HALSTED Mosquito Forceps	curved, extra delicate	5" (12.7 cm)
17-2600	JACOBSON Micro Mosquito Forceps	straight, extremely delicate	5" (12.7 cm)
17-2602	JACOBSON Micro Mosquito Forceps	curved, extremely delicate	5" (12.7 cm)
7-11	PACKER Mosquito Forceps	straight, flat jaws	5" (12.7 cm)
7-12	PACKER Mosquito Forceps	curved, flat jaws	5" (12.7 cm)



Hemostatic Forceps, Mosquito

REF	Description	Teeth	Type	Length
7-14	HALSTED Mosquito Forceps	1 x 2	straight	5" (12.7 cm)
7-16	HALSTED Mosquito Forceps	1 x 2	curved	5" (12.7 cm)
7-20	HALSTED Mosquito Forceps	-	jaws angled 45° on flat, extra delicate	4-1/2" (11.4 cm)
7-24	HARTMAN Mosquito Forceps	-	straight	3-1/2" (8.9 cm)
7-26	HARTMAN Mosquito Forceps	-	curved	3-1/2" (8.9 cm)
7-24A	HARTMAN LEE Mosquito Forceps	-	straight jaws, shanks angled on flat	3-1/2" (8.9 cm)
7-250	MOSQUITO Hemostatic Forceps	-	straight, delicate	8-1/4" (21 cm)
7-252	MOSQUITO Hemostatic Forceps	-	curved, delicate	8-1/4" (21 cm)
7-254	MOSQUITO Hemostatic Forceps	-	right angle, delicate	7-3/4" (19.7 cm)



7-14

7-16



7-20



7-24

7-26



7-24A



7-250

7-252

7-254

Hemostatic Forceps

REF	Description	Teeth	Type	Length
7-30	PROVIDENCE HOSPITAL Forceps	-	straight	5-1/2" (14 cm)
7-32	PROVIDENCE HOSPITAL Forceps	-	curved	5-1/2" (14 cm)
7-36	KELLY Forceps	-	straight	5-1/2" (14 cm)
7-38	KELLY Forceps	-	curved	5-1/2" (14 cm)
7-42	CRILE Forceps	-	straight	5-1/2" (14 cm)
7-44	CRILE Forceps	-	curved	5-1/2" (14 cm)
7-46	CRILE Forceps	-	straight	6-1/4" (15.9 cm)
7-48	CRILE Forceps	-	curved	6-1/4" (15.9 cm)
7-50	Baby CRILE Forceps	-	extra delicate, straight	5-1/2" (14 cm)
7-52	Baby CRILE Forceps	-	extra delicate, curved	5-1/2" (14 cm)
7-70	Baby OCHSNER Forceps	1 x 2	extra delicate, straight	5-1/2" (14 cm)
7-72	Baby OCHSNER Forceps	1 x 2	extra delicate, curved	5-1/2" (14 cm)



7-30



7-36



7-42



7-46



7-50



7-70

Hemostatic Forceps

REF	Description	Teeth	Type	Length			
7-60	LAHEY Forceps	-	straight	5-1/2" (14 cm)			
7-62	LAHEY Forceps	-	curved	5-1/2" (14 cm)			
7-82	JONES Forceps	-	straight	5" (12.7 cm)			
7-84	JONES Forceps	- <tr <td>7-90</td> <td>COLLIER Forceps</td> <td>-</td> <td>delicate, straight</td> <td>6-1/4" (15.9 cm)</td>	7-90	COLLIER Forceps	-	delicate, straight	6-1/4" (15.9 cm)
7-91	COLLIER Forceps	-	delicate, curved	6-1/4" (15.9 cm)			
7-92	RANKIN Forceps	-	straight	6-1/4" (15.9 cm)			
7-94	RANKIN Forceps	-	curved	6-1/4" (15.9 cm)			
7-98	LOVELACE Forceps	1 x 2	straight, cross-serrations	6-1/4" (15.9 cm)			
7-102	DANDY Forceps	-	curved sideways	5-1/2" (14 cm)			
7-106	PRATT T-Shape Forceps	-	-	6" (15.2 cm)			



7-60



7-82



7-90



7-92



7-98



7-102



7-106

Hemostatic Forceps

REF	Description	Teeth	Type	Length
30-1700	HEANEY Hysterectomy Forceps	-	heavy pattern, single tooth, curved	8-1/4" (21 cm)
30-1710	HEANEY Hysterectomy Forceps	-	heavy pattern, double tooth, curved	8-1/4" (21 cm)
30-1715	HEANEY Hysterectomy Forceps	-	extra heavy pattern, double tooth, curved	9-1/4" (23.5 cm)
30-1716	HEANEY-BALLENTINE Hysterectomy Forceps	-	longitudinal serrations, single tooth, curved	8-1/2" (21.6 cm)
30-1718	BALLENTINE Hysterectomy Forceps	-	longitudinal serrations, single tooth, straight	8-1/2" (21.6 cm)
30-1720	GARLAND Hysterectomy Forceps	-	longitudinal serrations, single tooth, angled on flat	8-1/2" (21.6 cm)
30-1730	LONG Hysterectomy Forceps	1 x 2	longitudinal serrations, curved	7-1/2" (19.1 cm)
30-1735	PHANEUF Uterine Artery Forceps	1 x 2	horizontal serrated jaws, straight	8" (20.3 cm)
30-1740	PHANEUF Uterine Artery Forceps	1 x 2	horizontal serrated jaws, angled on flat	8" (20.3 cm)



30-1700



30-1710

30-1715



30-1716

30-1718



30-1720



30-1730



30-1735

30-1740

Hemostatic Forceps

REF	Description	Type	Length
29-280	WERTHIEM Pedicle Clamp	curved jaws, 2" (5.1 mm) long	9-3/4" (24.8 cm)
29-282	WERTHEIM-CULLEN Pedicle Clamp	right angle jaws, 2" (5.1 cm) long	8-1/2" (21.6 cm)
7-200	MIXTER Forceps	fully curved	6-1/4" (15.9 cm)
7-202	MIXTER Forceps	fully curved	7-1/4" (18.4 cm)
7-206	MIXTER Forceps	fully curved	9" (22.9 cm)
25-812	MIXTER Thoracic Forceps	90° angle jaws, longitudinal serrations	9" (22.9 cm)
25-814	MIXTER Thoracic Forceps	90° angle jaws, longitudinal serrations	11" (27.9 cm)
25-821	MILTEX Artery & Undermining Forceps	delicate, lightweight, fine, serrated 45 mm jaws	11" (27.9 cm)
25-834	BRIDGE Deep Surgery Forceps	straight, very delicate	11" (27.9 cm)
25-835	BRIDGE Deep Surgery Forceps	curved, very delicate	11" (27.9 cm)



29-280



29-282



7-200 to 7-206



25-814

25-812



25-821



21-835

25-834

Hemostatic Forceps

REF	Description	Type	Length
7-210	Baby MIXTER Forceps	fully curved, extra delicate	5-1/4" (13.3 cm)
7-210A	MIXTER Forceps LEE Modified	curved jaws, angled shank, delicate	5-1/4" (13.3 cm)
25-836	KANTROWITZ Thoracic Forceps	delicate right angle jaws	7-1/2" (19.1 cm)
25-837	KANTROWITZ Thoracic Forceps	delicate right angle jaws	9-1/2" (24.1 cm)
25-838	KANTROWITZ Thoracic Forceps	delicate right angle jaws	11" (27.9 cm)
25-840	FINOCHIETTO Thoracic Forceps	slightly curved jaws	9" (22.9 cm)
25-848	FINOCHIETTO Thoracic Forceps & Ligature Carrier	90° jaws with longitudinal serrations & suture holes at tip	9-1/2" (24.1 cm)



7-210



7-210A



25-836 to 25-838



25-840



25-848

Hemostatic Forceps

REF	Description	Type	Length
14-46	LOWER Gall Duct Forceps	-	7" (17.8 cm)
14-48	LAHEY Gall Duct Forceps	-	7-1/2" (19.1 cm)
14-49	LAHEY Gall Duct Forceps	-	9" (22.9 cm)
14-50	MOYNIHAN Gall Duct Forceps	-	8-1/2" (21.6 cm)
14-51	GREEN Cystic Duct Forceps	delicate	8-1/2" (21.6 cm)
14-52	JOHN HOPKINS Gall Bladder Forceps	-	8" (20.3 cm)
14-56	GRAY Cystic Duct Forceps	serrated, set of 2	9" (22.9 cm)
14-62	SHALLCROSS Cystic Duct Forceps	-	7" (17.8 cm)



14-46

14-48 14-49



14-50



14-51



14-52



14-56



14-62

Hemostatic Forceps

REF	Description	Type	Length
22-660	SCHNIDT Tonsil Hemostatic Forceps	slight curve, one open ring	7-1/2" (19.1 cm)
22-662	SCHNIDT Tonsil Hemostatic Forceps	slight curve, closed rings	7-1/2" (19.1 cm)
22-666	SAWTELL Tonsil Hemostatic Forceps	full curve, one open ring	7-1/2" (19.1 cm)
22-668	SAWTELL Tonsil Hemostatic Forceps	full curve, closed rings	7-1/2" (19.1 cm)
7-220	PENNINGTON Tissue Grasping Forceps	triangular jaws	6" (15.2 cm)
14-66	LOVELACE Gall Bladder Forceps	angular, 1" (25 cm) wide jaws	7-1/4" (18.4 cm)



22-660



22-662



22-666



22-668



7-220



14-66

Hemostatic Forceps

REF	Description	Type	Length
7-230	BAINBRIDGE Forceps	straight, longitudinal serrations, cross tip serrations	6" (15.2 cm)
7-232	BAINBRIDGE Forceps	curved, longitudinal serrations, cross tip serrations	6" (15.2 cm)
7-234	BAINBRIDGE Forceps	straight, longitudinal serrations, cross tip serrations	7-1/4" (18.4 cm)
7-236	BAINBRIDGE Forceps	curved, longitudinal serrations, cross tip serrations	7-1/4" (18.4 cm)
7-240	ADSON Forceps	straight	7-1/4" (18.4 cm)
7-242	ADSON Forceps	curved	7-1/4" (18.4 cm)
17-2603	JACOBSON Hemostatic Forceps	curved, extremely delicate	7" (17.8 cm)



7-230



7-236



7-240



17-2603

Hemostatic Forceps

REF	Description	Type	Length
16-3	Baby ALLIS Tissue Forceps	4 X 5 teeth, extra delicate jaws 2.5 mm wide	5" (12.7 cm)
16-4	Baby ALLIS Tissue Forceps	4 X 5 teeth, delicate jaws 4 mm wide	5-1/2" (14 cm)
16-6	ALLIS Tissue Forceps	4 X 5 teeth	6" (15.2 cm)
16-42	Baby BABCOCK Intestinal Forceps	delicate jaws 6 mm wide	5-1/2" (14 cm)
16-44	BABCOCK Intestinal Forceps	9 mm wide jaws	6-1/4" (15.9 cm)
16-46	BABCOCK Intestinal Forceps	10 mm wide jaws	8-1/4" (21 cm)
16-48	BABCOCK Intestinal Forceps	15 mm wide jaws	9-1/2" (24.1 cm)
16-99	DENNIS Anastomosis Clamp	longitudinal serrations	9" (22.9 cm)
16-100	ALLEN Intestinal Forceps	longitudinal serrations with 1 x 2 teeth	8" (20.3 cm)
16-102	Baby ALLEN Intestinal Clamp	delicate, longitudinal serrations with 1 x 2 teeth	6-1/2" (16.5 cm)
16-108	Baby DOYEN Intestinal Forceps	straight, flexible blades with diagonal serrations	6-3/4" (17.1 cm)
16-110	Baby DOYEN Intestinal Forceps	curved, flexible blades with diagonal serrations	6-3/4" (17.1 cm)
16-130	MAYO-ROBSON Intestinal Forceps	straight, longitudinal serrations	10" (25.4 cm)
16-132	MAYO-ROBSON Intestinal Forceps	curved, longitudinal serrations	9-1/2" (24.1 cm)



16-3
16-4



16-6



16-42 to
16-48



16-99



16-100



16-102



16-108

16-110



16-130

16-132

Hemostatic Forceps

REF	Description	Type	Length
16-140	SCUDDER Intestinal Forceps	straight, solid smooth blades	9-1/2" (24.1 cm)
16-160	DOYEN Intestinal Forceps	straight, flexible blades with longitudinal serrations	9" (22.9 cm)
16-162	DOYEN Intestinal Forceps	curved, flexible blades with longitudinal serrations	9" (22.9 cm)
7-255	GEMINI-MIXTER Hemostatic Forceps	delicate, full curved jaws	5-1/2" (14 cm)
7-256	GEMINI-MIXTER Hemostatic Forceps	delicate, full curved jaws	7" (17.8 cm)
7-257	GEMINI-MIXTER Hemostatic Forceps	delicate, full curved jaws	8" (20.3 cm)
7-258	GEMINI-MIXTER Hemostatic Forceps	delicate, full curved jaws	9" (22.9 cm)
7-259	GEMINI-MIXTER Hemostatic Forceps	delicate, full curved jaws	11" (27.9 cm)
25-780	RUMEL Thoracic Forceps	slight curve, 2-3/8" (6.1 cm) long jaws	9" (22.9 cm)
25-782	RUMEL Thoracic Forceps	medium curve, 2-3/8" (6.1 cm) long jaws	9" (22.9 cm)
25-784	RUMEL Thoracic Forceps	full curve, 2-3/8" (6.1 cm) long jaws	9" (22.9 cm)
25-786	RUMEL Thoracic Forceps	angular, 2-3/8" (6.1 cm) long jaws	9" (22.9 cm)



16-140



16-162

16-160



7-255 to 7-259

7-255



25-780

25-782

25-784

25-786

25-780

Hemostatic Forceps

REF	Description	Teeth	Type	Length
7-260	FERGUSON Angiotribe Hemostatic Forceps	-	straight	6-1/2" (16.5 cm)
7-262	FERGUSON Angiotribe Hemostatic Forceps	-	curved	6-1/2" (16.5 cm)
7-264	FERGUSON Angiotribe Hemostatic Forceps	-	straight	7-1/2" (19.1 cm)
7-266	FERGUSON Angiotribe Hemostatic Forceps	-	curved	7-1/2" (19.1 cm)
25-800	SAROT Intra-Thoracic Artery Forceps	-	with 2-1/2" (6.4 cm) long jaws	10" (25.4 cm)
30-1025	JACOBS Uterine Vulsellum Forceps	2 x 2	straight, serrated jaws	8-1/2" (21.6 cm)
30-1030	JACOBS Uterine Vulsellum Forceps	2 x 2	curved sideways, serrated jaws	8-1/2" (21.6 cm)
30-1050-6	MUSEUX Uterine Vulsellum Forceps	2 x 2	straight, 6 mm jaws	9-1/2" (24.1 cm)
30-1050-8	MUSEUX Uterine Vulsellum Forceps	2 x 2	straight, 8 mm jaws	9-1/2" (24.1 cm)
30-1050-10	MUSEUX Uterine Vulsellum Forceps	2 x 2	straight, 10 mm jaws	9-1/2" (24.1 cm)



7-260



7-262



7-264



7-266



25-800



30-1025



30-1030



30-1050-6



30-1050-8



30-1050-10

Hemostatic Forceps

REF	Description	Teeth	Type	Length
7-66	KOCHER Forceps	1 x 2	straight	5-1/2" (14 cm)
7-68	KOCHER Forceps	1 x 2	curved	5-1/2" (14 cm)
7-190	MICULICZ Peritoneal Forceps	1 x 2	slight curve	8" (20.3 cm)
16-120	KOCHER Intestinal Forceps	-	straight, longitudinal serrations	10-1/2" (26.7 cm)
16-122	KOCHER Intestinal Forceps	-	curved, longitudinal serrations	10-1/2" (26.7 cm)
24-1000	GLOVER Patent Ductus Forceps	-	straight, 3 cm jaws	8" (20.3 cm)
24-1002	GLOVER Patent Ductus Forceps	-	angular, 3 cm jaws	8" (20.3 cm)



7-66



7-190



16-120



24-1000



24-1002

ROCHESTER-PEAN Hemostatic Forceps

REF	Description	Type	Length
7-110	Baby PEAN Forceps	straight, extra delicate	5-1/2" (14 cm)
7-112	Baby PEAN Forceps	curved, extra delicate	5-1/2" (14 cm)
7-118	ROCHESTER-PEAN Forceps	straight	5-1/2" (14 cm)
7-120	ROCHESTER-PEAN Forceps	straight	6-1/4" (15.9 cm)
7-122	ROCHESTER-PEAN Forceps	straight	7-1/4" (18.4 cm)
7-124	ROCHESTER-PEAN Forceps	straight	8" (20.3 cm)
7-126	ROCHESTER-PEAN Forceps	straight	8-3/4" (22.2 cm)
7-128	ROCHESTER-PEAN Forceps	straight	10-1/4" (26 cm)
7-130	ROCHESTER-PEAN Forceps	straight	12" (30.5 cm)
7-136	ROCHESTER-PEAN Forceps	curved	5-1/2" (14 cm)
7-138	ROCHESTER-PEAN Forceps	curved	6-1/4" (15.9 cm)
7-140	ROCHESTER-PEAN Forceps	curved	7-1/4" (18.4 cm)
7-142	ROCHESTER-PEAN Forceps	curved	8" (20.3 cm)
7-144	ROCHESTER-PEAN Forceps	curved	8-3/4" (22.2 cm)
7-146	ROCHESTER-PEAN Forceps	curved	10-1/4" (26 cm)
7-148	ROCHESTER-PEAN Forceps	curved	12" (30.5 cm)
30-1805	PEAN Hysterectomy Forceps	curved, longitudinal serrations	8-3/4" (22.2 cm)
30-1815	PEAN Hysterectomy Forceps	curved, longitudinal serrations	10-1/4" (26 cm)



7-112

7-110

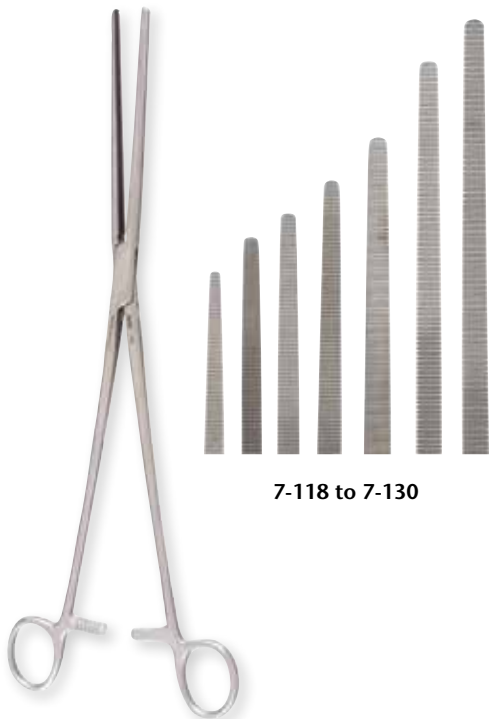

7-118 to 7-130

7-130



7-136 to 7-148



30-1815

30-1805

Hemostatic Forceps

REF	Description	Teeth	Type	Length
7-150	ROCHESTER-OCHSNER Forceps	1 x 2	straight	6-1/4" (15.9 cm)
7-152	ROCHESTER-OCHSNER Forceps	1 x 2	straight	7-1/4" (18.4 cm)
7-154	ROCHESTER-OCHSNER Forceps	1 x 2	straight	8" (20.3 cm)
7-156	ROCHESTER-OCHSNER Forceps	1 x 2	straight	9" (22.9 cm)
7-157	ROCHESTER-OCHSNER Forceps	1 x 2	straight	10" (25.4 cm)
7-160	ROCHESTER OCHSNER Forceps	1 x 2	curved	6-1/4" (15.9 cm)
7-162	ROCHESTER-OCHSNER Forceps	1 x 2	curved	7-1/4" (18.4 cm)
7-164	ROCHESTER-OCHSNER Forceps	1 x 2	curved	8" (20.3 cm)
7-166	ROCHESTER-OCHSNER Forceps	1 x 2	curved	9" (22.9 cm)
7-167	ROCHESTER-OCHSNER Forceps	1 x 2	curved	10" (25.4 cm)
7-170	ROCHESTER-CARMALT Forceps	-	straight	6-1/4" (15.9 cm)
7-172	ROCHESTER-CARMALT Forceps	-	curved	6-1/4" (15.9 cm)
7-180	ROCHESTER-CARMALT Forceps	-	straight	8" (20.3 cm)
7-182	ROCHESTER-CARMALT Forceps	-	curved	8" (20.3 cm)

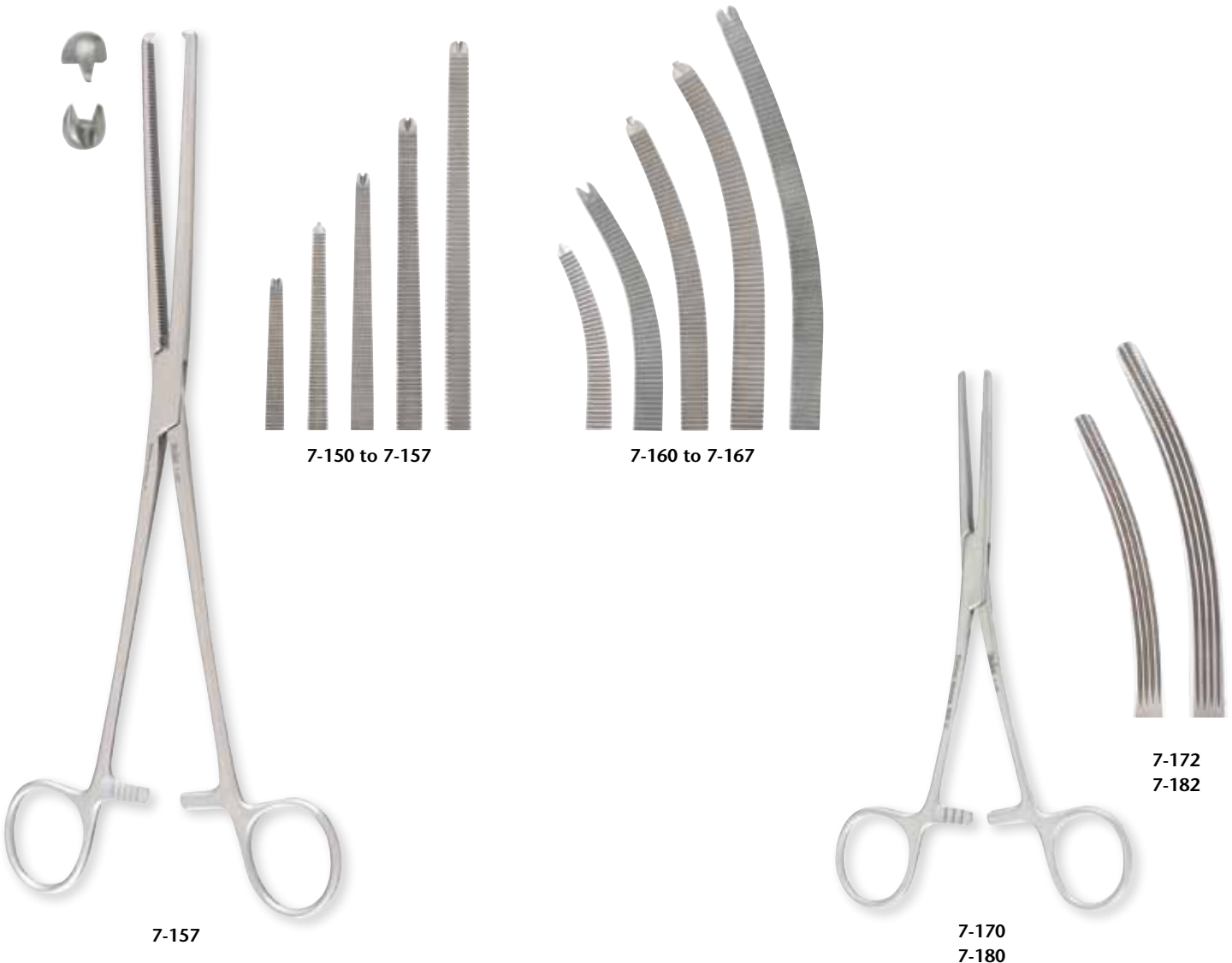

Hemostatic Clamps

REF	Description	Type	Length
7-280	JOHN HOPKINS Bulldog Clamp	straight	1-1/2" (3.8 cm)
7-282	JOHN HOPKINS Bulldog Clamp	straight	2" (5.1 cm)
7-284	JOHN HOPKINS Bulldog Clamp	straight	2-1/2" (6.4 cm)
7-286	JOHN HOPKINS Bulldog Clamp	straight	3" (7.6 cm)
7-290	JOHN HOPKINS Bulldog Clamp	curved	1-1/2" (3.8 cm)
7-292	JOHN HOPKINS Bulldog Clamp	curved	2" (5.1 cm)
7-294	JOHN HOPKINS Bulldog Clamp	curved	2-1/2" (6.4 cm)
7-296	JOHN HOPKINS Bulldog Clamp	curved	3" (7.6 cm)
7-298	JOHN HOPKINS Bulldog Clamp	curved	3-1/2" (8.9 cm)
7-300	DIEFFENBACH Serrefine	straight	2-1/4" (5.7 cm)
7-302	DIEFFENBACH Serrefine	curved	2-1/4" (5.7 cm)
7-304	DIEFFENBACH Serrefine	straight	1-1/2" (3.8 cm)
7-305	DIEFFENBACH Serrefine	curved	1-1/2" (3.8 cm)
7-310	DIETRICH Micro Bulldog Clamp	straight jaws 8 mm x 1.2 mm	1-7/8" (4.7 cm)
7-315	DIETRICH Micro Bulldog Clamp	angled jaws 8 mm x 1.2 mm	1-3/4" (4.4 cm)

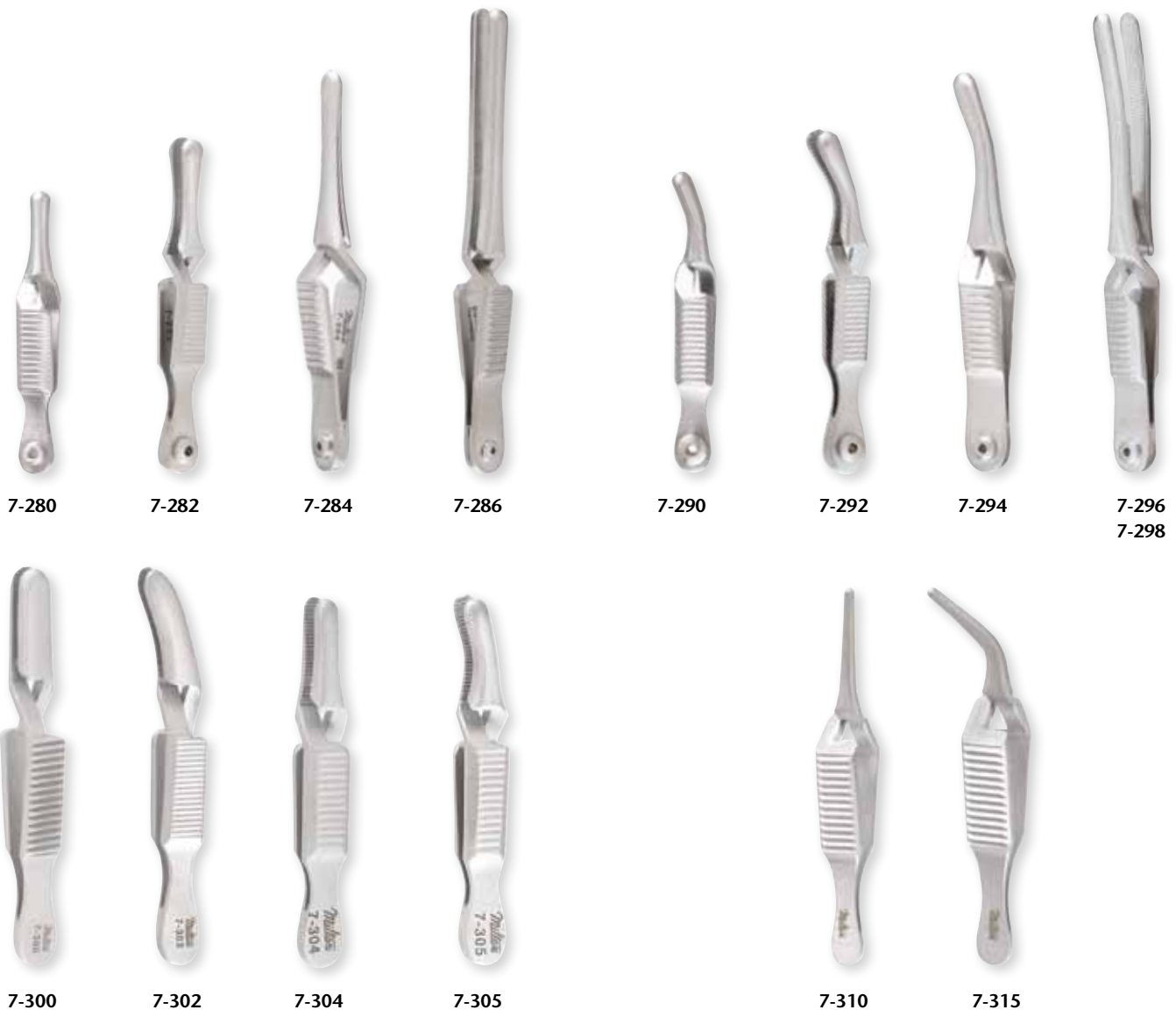

Towel Clamps & Forceps

TOWEL CLAMPS and FORCEPS are designed to secure toweling and operating room drapes to the skin during surgical procedures. Towel forceps are available in perforating and non-perforating types.

REF	Description	Type	Length
7-500	JONES Towel Clamp	standard size	3-1/2" (8.9 cm)
7-501	JONES Towel Clamp	lightweight	2-1/4" (5.7 cm)
7-504	BACKHAUS Towel Clamp	-	3-1/2" (8.9 cm)
7-506	BACKHAUS Towel Clamp	-	5-1/4" (13.3 cm)
7-510	ROEDER Towel Clamp	with Ball Stops	5-1/4" (13.3 cm)
7-514	LORNA Non-Perforating Towel Forceps	-	3-1/2" (8.9 cm)
7-515	LORNA Non-Perforating Towel Forceps	-	5-1/4" (13.3 cm)



7-500



7-501



7-504
7-506



7-510



7-514
7-515

Sponge Forceps

REF	Description	Type	Length
7-600	FOERSTER Sponge Forceps	straight, serrated jaws	9-1/2" (24.1 cm)
7-602	FOERSTER Sponge Forceps	straight, smooth jaws	9-1/2" (24.1 cm)
7-604	FOERSTER Sponge Forceps	straight, serrated jaws	7" (17.8 cm)
7-606	FOERSTER Sponge Forceps	straight, smooth jaws	7" (17.8 cm)
7-610	FOERSTER Sponge Forceps	curved, serrated jaws	9-1/2" (24.1 cm)
7-612	FOERSTER Sponge Forceps	curved, smooth jaws	9-1/2" (24.1 cm)
7-614	FOERSTER Sponge Forceps	curved, serrated jaws	7" (17.8 cm)
7-616	FOERSTER Sponge Forceps	curved, smooth jaws	7" (17.8 cm)
30-2505	KELLY Sponge or Placenta Forceps	serrated ring jaws, slightly curved	12-1/2" (31.8 cm)



7-600
7-604



7-602
7-606



7-610
7-612



30-2505

Sponge Forceps

REF	Description	Type	Length
7-620	BOZEMAN Sponge Forceps	straight	10-1/4" (26 cm)
7-622	BOZEMAN Sponge Forceps	double curved	10-1/4" (26 cm)
7-624	BOZEMAN Sponge Forceps	double curved, one large ring	10-1/4" (26 cm)
7-630	FLETCHER Sponge Forceps	straight	9-1/2" (24.1 cm)
7-632	FLETCHER Sponge Forceps	curved	9-1/2" (24.1 cm)



7-620



7-622



7-624



7-630

7-632

MILTEX® NEEDLE HOLDERS

Premium Needle Holders.....	106-114
Ceram-A-Grip® Needle Holders.....	115-116
Standard Needle Holders.....	117-123
Microsurgical Needle Holders.....	124-126



ANATOMY OF A MILTEX® NEEDLE HOLDER

The Miltex® Repair and Service Team offers extensive instrument refurbishment and tungsten carbide jaw replacement services. Contact us for more information.



Carb-N-Sert® (Tungsten Carbide Type)

Carb-N-Sert® jaws are made of tungsten carbide bonded to needle holders of the finest quality stainless steel.

Jaws are custom crafted with very fine teeth and are appropriate to the size of the instrument and the sizes of needles and sutures. Needle holder patterns are also available with smooth Carb-N-Sert® jaws, designed to hold the smallest suture in microsurgical and plastic surgery procedures.

The jaw edge is chamfered to prevent accidental cutting of suture material.

TEETH

Teeth are precision milled into the tungsten carbide, forming sharp pyramid-shapes and providing a positive non-slip surface.

BOX LOCK

The box lock has a distinct non-catch bevel which prevents fraying of suture material.

LASER ETCHING

Miltex® needle holders are laser etched with our logo and catalog number for easy re-ordering.

SATIN FINISH

Each instrument is satin finished to reduce glare.

RING HANDLES

Well rounded and polished handles provide a more comfortable grip.

* Note: cold or chemical sterilization is not recommended for tungsten carbide instruments

Please see our reference section for recommended suture sizes

CARB-N-SERT® Needle Holders

Miltex® Tungsten Carbide Needle Holders ensure a firm grip on needles and suture as well as an extended service life over that of standard stainless steel.

REF	Description	Type	Teeth Per Sq. Inch	Tip	Length
8-3TC	PAR Needle Holder	delicate, serrated	16000	Carb-N-Sert	4-1/2" (11.4 cm)
8-5TC	PAR Needle Holder	delicate, serrated	16000	Carb-N-Sert	5" (12.7 cm)
8-4TC	DERF Needle Holder	serrated	4000	Carb-N-Sert	4-3/4" (12.1 cm)
8-6TC	WEBSTER Needle Holder	delicate, smooth	-	Carb-N-Sert	5-1/4" (13.3 cm)
8-7TC	WEBSTER Needle Holder	extra delicate, smooth	-	Carb-N-Sert	4-3/4" (12.1 cm)
8-7A-TC	WEBSTER (JOHNSON) Needle Holder	extra delicate, serrated	4000	Carb-N-Sert	4-3/4" (12.1 cm)
8-8TC	HALSEY Needle Holder	smooth	-	Carb-N-Sert	5" (12.7 cm)
8-8A-TC	HALSEY Needle Holder	serrated	4000	Carb-N-Sert	5" (12.7 cm)



8-3TC
8-5TC



8-4TC



8-6TC



8-7TC
8-7A-TC



8-8TC
8-8A-TC

CARB-N-SERT® Needle Holders

REF	Description	Type	Teeth P. Sq. Inch	Tip	Length
8-14TC	OLSEN-HEGAR Needle Holder w/ suture scissors	serrated	4000	Carb-N-Sert	4-3/4" (12.1 cm)
8-14A-TC	OLSEN-HEGAR Needle Holder w/ suture scissors	smooth	-	Carb-N-Sert	4-3/4" (12.1 cm)
8-15TC	OLSEN-HEGAR Needle Holder w/ suture scissors	serrated	2600	Carb-N-Sert	5-1/2" (14 cm)
8-16TC	OLSEN-HEGAR Needle Holder w/ suture scissors	serrated	2600	Carb-N-Sert	6-1/2" (16.5 cm)
8-17TC	OLSEN-HEGAR Needle Holder w/ suture scissors	serrated	2600	Carb-N-Sert	7-1/2" (19.1 cm)
8-28TC	MATHIEU Needle Holder	serrated	2600	Carb-N-Sert	5-1/2" (14 cm)
8-30TC	MATHIEU Needle Holder	serrated	2600	Carb-N-Sert	6-1/4" (15.9 cm)
8-40TC	BAUMGARTNER Needle Holder	serrated	4000	Carb-N-Sert	5-1/2" (14 cm)



8-14TC
8-14A-TC



8-15TC
8-16TC
8-17TC



8-28TC



8-30TC



8-40TC

CARB-N-SERT® Needle Holders

REF	Description	Type	Teeth P. Sq. Inch	Type	Length
8-42TC	MAYO-HEGAR Needle Holder	serrated	2600	Carb-N-Sert	5" (12.7 cm)
8-44TC	MAYO-HEGAR Needle Holder	serrated	2600	Carb-N-Sert	6-1/4" (15.9 cm)
8-46TC	MAYO-HEGAR Needle Holder	serrated	2600	Carb-N-Sert	7-1/4" (18.4 cm)
8-48TC	MAYO-HEGAR Needle Holder	serrated	2600	Carb-N-Sert	8" (20.3 cm)
8-130TC	MAYO-HEGAR (MASSON) Needle Holder	serrated	2600	Carb-N-Sert	10-1/2" (26.7 cm)
8-49TC	MAYO-HEGAR Needle Holder	serrated	2600	Carb-N-Sert	12" (30.5 cm)
8-50TC	CRILE-WOOD Needle Holder	serrated	4000	Carb-N-Sert	6" (15.2 cm)
8-50A-TC	CRILE-WOOD Needle Holder	smooth	-	Carb-N-Sert	6" (15.2 cm)



8-42TC to
8-48TC

8-130TC
8-49TC

8-50TC
8-50A-TC

CARB-N-SERT® Needle Holders

REF	Description	Type	Teeth P. Sq. Inch	Type	Length
8-51TC	CRILE-WOOD (DeBakey) Needle Holder	serrated	4000	Carb-N-Sert	7" (17.8 cm)
8-52TC	CRILE-WOOD (DeBakey) Needle Holder	serrated	2600	Carb-N-Sert	8" (20.3 cm)
8-53TC	CRILE-WOOD (DeBakey) Needle Holder	serrated	2600	Carb-N-Sert	9" (22.9 cm)
8-55TC	CRILE-WOOD (DeBakey) Needle Holder	serrated	2600	Carb-N-Sert	10-1/2" (26.7 cm)
8-57TC	CRILE-WOOD (DeBakey) Needle Holder	serrated	2600	Carb-N-Sert	12" (30.5 cm)
8-62TC	COOLEY Needle Holder	extra delicate, serrated	4000	Carb-N-Sert	6" (15.2 cm)
8-63TC	COOLEY Needle Holder	extra delicate, serrated	4000	Carb-N-Sert	6-3/4" (17.1 cm)
8-65TC	RYDER -Type Intracardiac Needle Holder	extra delicate, serrated	4000	Carb-N-Sert	5" (12.7 cm)
8-66TC	RYDER -Type Intracardiac Needle Holder	extra delicate, serrated	4000	Carb-N-Sert	6" (15.2 cm)
8-67TC	RYDER -Type Intracardiac Needle Holder	extra delicate, serrated	4000	Carb-N-Sert	7" (17.8 cm)
8-69TC	RYDER -Type Intracardiac Needle Holder	extra delicate, serrated	4000	Carb-N-Sert	9" (22.9 cm)
8-81TC	NEW ORLEANS Needle Holder	serrated	2600	Carb-N-Sert	7" (17.8 cm)



8-51TC to 8-57TC



8-62TC
8-63TC



8-65TC to
8-69TC



8-81TC

CARB-N-SERT® Needle Holders

REF	Description	Type	Teeth P. Sq. Inch	Tip	Length
8-82TC	JULIAN Pattern Needle Holder	serrated	2600	Carb-N-Sert	8-1/4" (21 cm)
8-83TC	JULIAN Pattern Needle Holder	serrated, curved	2600	Carb-N-Sert	8-1/4" (21 cm)
8-96TC	SAROT Needle Holder	serrated	2600	Carb-N-Sert	7-1/4" (18.4 cm)
8-114TC	SAROT Needle Holder	serrated	2600	Carb-N-Sert	10-1/2" (26.7 cm)
8-100TC	HEANY Needle Holder	serrated, curved	2600	Carb-N-Sert	8-1/2" (21.6 cm)
8-102TC	STRATTE Needle Holder	serrated, curved	2600	Carb-N-Sert	9" (22.9 cm)
22-500TC	Wire Twister	serrated	-	Carb-N-Sert	6" (15.2 cm)
22-502TC	Wire Twister	serrated	-	Carb-N-Sert	8" (20.3 cm)



8-82TC
8-83TC



8-96TC
8-114TC



8-100TC



8-102TC



22-500TC
22-502TC

CARB-N-SERT® Needle Holders

REF	Description	Type	Teeth P. Sq. Inch	Tip	Length
29-310TC	BIHRLE Needle Holder/Clamp	serrated & smooth	-	Carb-N-Sert	11" (27.9 cm)
8-101TC	RYDER Needle Holder	serrated	4000	Carb-N-Sert	5" (12.7 cm)
8-103TC	RYDER Needle Holder	serrated	4000	Carb-N-Sert	6" (15.2 cm)
8-104TC	RYDER Needle Holder	serrated	4000	Carb-N-Sert	7" (17.8 cm)
8-105TC	RYDER Needle Holder	serrated	4000	Carb-N-Sert	8" (20.3 cm)
8-106TC	RYDER Needle Holder	serrated	4000	Carb-N-Sert	9" (22.9 cm)
8-107TC	RYDER Needle Holder	serrated	4000	Carb-N-Sert	10-1/4" (26 cm)
8-134TC	WANGENSTEEN Needle Holder	serrated	2600	Carb-N-Sert	10-3/4" (27.3 cm)
18-1816TC	MILTEX-CASTROVIEJO Needle Holder	delicate, with lock, smooth	-	Carb-N-Sert	4-3/4" (12.1 cm)



29-310TC



8-101TC to 8-107TC



8-134TC



18-1816TC

CARB-N-SERT® Needle Holders

REF	Description	Type	Teeth P. Sq. Inch	Tip	Length
18-1828TC	CASTROVIEJO Needle Holder	with lock, smooth, straight	-	Carb-N-Sert	5-1/2" (14 cm)
18-1828A-TC	CASTROVIEJO Needle Holder	with lock, serrated, straight	16000	Carb-N-Sert	5-1/2" (14 cm)
18-1832TC	CASTROVIEJO Needle Holder	with lock, smooth, curved	-	Carb-N-Sert	5-1/2" (14 cm)
18-1832A-TC	CASTROVIEJO Needle Holder	with lock, serrated, curved	16000	Carb-N-Sert	5-1/2" (14 cm)
17-1090TC	JACOBSON Microvascular Needle Holder	with lock, serrated, straight	16000	Carb-N-Sert	7" (17.8 cm)
17-1091TC	JACOBSON Microvascular Needle Holder	with lock, serrated, curved	16000	Carb-N-Sert	7" (17.8 cm)
17-1092TC	JACOBSON Microvascular Needle Holder	with lock, serrated, straight	16000	Carb-N-Sert	8-1/2" (21.6 cm)



18-1828TC
18-1828A-TC



18-1832TC
18-1832A-TC



17-1090TC to
17-1092TC

CARB-N-SERT® Needle Holders

REF	Description	Type	Tip	Length
PM-2420	NEIVERT Needle Holder	one angled ring, serrated	Carb-N-Sert	5" (12.7 cm)
PM-2424	PARKHOUSE Needle Holder/Scissors	offset ring, serrated	Carb-N-Sert	5-1/2" (14 cm)
PM-2425	GILLIES Needle Holder	curved, serrated	Carb-N-Sert	6-1/4" (15.9 cm)
PM-2426	Swedish Needle Holder	serrated, light handles	Carb-N-Sert	6" (15.2 cm)

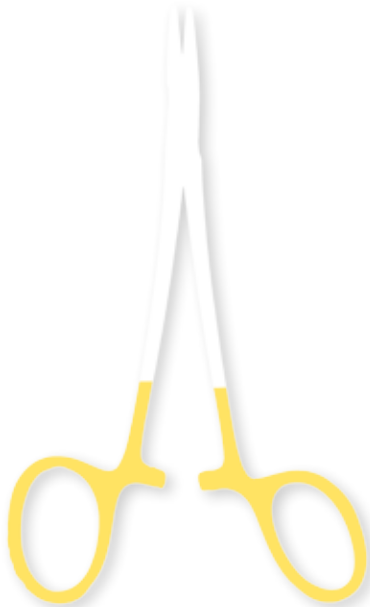

PM-2420



PM-2424

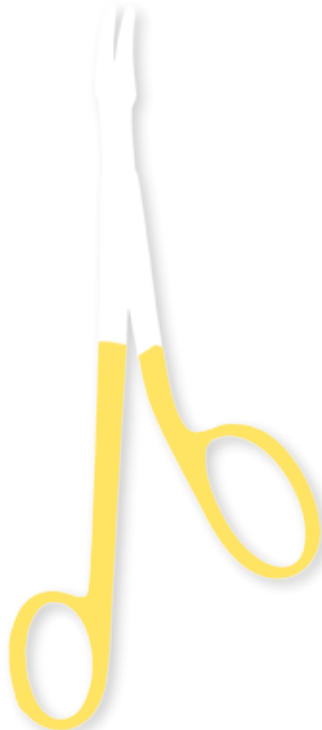

PM-2425

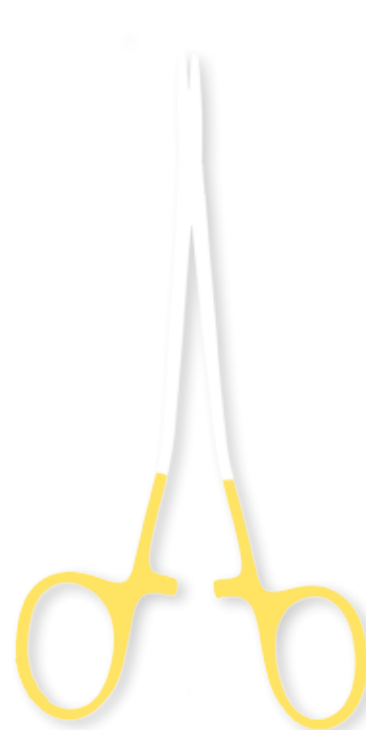

PM-2426

CARB-N-SERT® Needle Holders, Quick-Release

The special quick-release ratchet is offered on our most popular patterns. The offset ratchet design provides ease of use for the clinician's grip and for suturing techniques. Also suitable for the left handed user.

REF	Description	Type	Teeth Per Sq. Inch	Tip	Length
8-706TC	WEBSTER Quick-Release Needle Holder	smooth	-	Carb-N-Sert	5" (12.7 cm)
8-744TC	MAYO-HEGAR Quick-Release Needle Holder	serrated	2600	Carb-N-Sert	6" (15.2 cm)
8-746TC	MAYO-HEGAR Quick-Release Needle Holder	serrated	2600	Carb-N-Sert	7" (17.8 cm)
8-748TC	MAYO-HEGAR Quick-Release Needle Holder	serrated	2600	Carb-N-Sert	8" (20.3 cm)
8-750TC	CRILE-WOOD Quick-Release Needle Holder	serrated	2600	Carb-N-Sert	6" (15.2 cm)
8-751TC	CRILE-WOOD Quick-Release Needle Holder	serrated	2600	Carb-N-Sert	7" (17.8 cm)
8-752TC	CRILE-WOOD Quick-Release Needle Holder	serrated	2600	Carb-N-Sert	8" (20.3 cm)
8-753TC	CRILE-WOOD Quick-Release Needle Holder	serrated	2600	Carb-N-Sert	9" (22.9 cm)



8-706TC



8-744TC to 8-748TC



8-750TC to 8-753TC

CERAM-A-GRIP® Needle Holders

CERAM-A-GRIP® Needle Holders have fusion bonded jaws with a durable ceramic material.

CERAM-A-GRIP® Needle Holders have dark green handles for easy identification.

REF	Description	Type	Length
8-4CG	DERF Needle Holder	CERAM-A-GRIP coated jaws	4-3/4" (21.1 cm)
8-6CG	WEBSTER Needle Holder	delicate, standard pattern, smooth CERAM-A-GRIP coated jaws	5" (12.7 cm)
8-7CG	WEBSTER Needle Holder	extra delicate, smooth CERAM-A-GRIP coated jaws	4-3/4" (12.1 cm)
8-8CG	HALSEY Needle Holder	smooth CERAM-A-GRIP coated jaws	5" (12.7 cm)
8-15CG	OLSEN-HEGAR Needle Holder	CERAM-A-GRIP jaws with Suture Scissors	5-1/2" (14 cm)
8-16CG	OLSEN-HEGAR Needle Holder	CERAM-A-GRIP jaws with Suture Scissors	6-1/2" (16.5 cm)

Exclusive ceramic material is fusion bonded to the needle holder's jaws (8-16CG detail shown).



8-4CG



8-6CG
8-7CG



8-8CG



8-15CG to 8-16CG

CERAM-A-GRIP® Needle Holders

REF	Description	Type	Length
8-40CG	BAUMGARTNER Needle Holder	CERAM-A-GRIP coated jaws	5-1/2" (14 cm)
8-42CG	MAYO-HEGAR Needle Holder	CERAM-A-GRIP coated jaws	5" (12.7 cm)
8-44CG	MAYO-HEGAR Needle Holder	CERAM-A-GRIP coated jaws	6-1/4" (15.9 cm)
8-46CG	MAYO-HEGAR Needle Holder	CERAM-A-GRIP coated jaws	7-1/4" (18.4 cm)
8-48CG	MAYO-HEGAR Needle Holder	CERAM-A-GRIP coated jaws	8" (20.3 cm)
8-50CG	CRILE-WOOD Needle Holder	CERAM-A-GRIP coated jaws	6" (15.2 cm)
8-51CG	CRILE-WOOD Needle Holder	CERAM-A-GRIP coated jaws	7" (17.8 cm)
8-52CG	CRILE-WOOD Needle Holder	CERAM-A-GRIP coated jaws	8" (20.3 cm)



8-40CG



8-42CG to 8-48CG



8-50CG to 8-52CG

Needle Holders

REF	Description	Type	Length
8-2	COLLIER Needle Holder	fenestrated jaws	5" (12.7 cm)
8-4	DERF Needle Holder	serrated	4-3/4" (12.1 cm)
8-6	WEBSTER Needle Holder	delicate, smooth jaws, standard pattern	5" (12.7 cm)
8-7	WEBSTER Needle Holder	extra delicate, smooth jaws, standard pattern	4-3/4" (12.1 cm)
8-8	HALSEY Needle Holder	smooth jaws	5" (12.7 cm)
8D-36	HALSEY Needle Holder	serrated jaws	5" (12.7 cm)



8-2



8-4



8-6
8-7



8-8



8D-36

Needle Holders

REF	Description	Type	Length
8-10	ABBAY Needle Holder	-	5" (12.7 cm)
8-12	NEIVERT Needle Holder	one offset ring	5" (12.7 cm)
8-14	OLSEN-HEGAR Needle Holder with Suture Scissors	extra delicate pattern, serrated jaws	4-3/4" (12.1 cm)
8-14A	OLSEN-HEGAR Needle Holder with Suture Scissors	extra delicate pattern, smooth jaws	4-3/4" (12.1 cm)
8-15	OLSEN-HEGAR Needle Holder with Suture Scissors	serrated jaws	5-1/2" (14 cm)
8-16	OLSEN-HEGAR Needle Holder with Suture Scissors	serrated jaws	6-1/2" (16.5 cm)
8-17	OLSEN-HEGAR Needle Holder with Suture Scissors	serrated jaws	7-1/4" (18.4 cm)
8-20	CONVERSE Needle Holder	longitudinal serrations, large finger rings	4-1/4" (10.8 cm)



8-10



8-12



8-14



8-14A



8-15 to 8-17



8-20

Needle Holders

REF	Description	Type	Length
8-22	BROWN Needle Holder	convex jaws, fine serrations	5-1/4" (13.3 cm)
8-23	BROWN Needle Holder	convex jaws, fine serrations	6-3/4" (17.1 cm)
8-26	BOYNTON Needle Holder	delicate	5" (12.7 cm)
8-28	MATHIEU Needle Holder	with spring handles	5-1/2" (14 cm)
8-30	MATHIEU Needle Holder	with spring handles	6-1/4" (15.9 cm)
8-32	MATHIEU Needle Holder	with spring handles	7-1/2" (19.1 cm)
8-40	BAUMGARTNER Needle Holder	-	5-1/2" (14 cm)



8-22
8-23

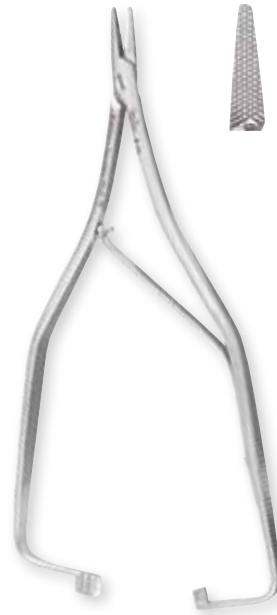

8-26



8-28



8-30 to
8-32



8-40

Needle Holders

REF	Description	Type	Length
8-42	MAYO-HEGAR Needle Holder	-	5" (12.7 cm)
8-44	MAYO-HEGAR Needle Holder	-	6-1/4" (15.9 cm)
8-46	MAYO-HEGAR Needle Holder	-	7-1/4" (18.4 cm)
8-48	MAYO-HEGAR Needle Holder	-	8" (20.3 cm)
8-130	MAYO-HEGAR (MASSON) Needle Holder	-	10-1/2" (26.7 cm)
8-50	CRILE-WOOD Needle Holder	-	6" (15.2 cm)
8-51	CRILE-WOOD Needle Holder	-	7" (17.8 cm)
8-52	CRILE-WOOD Needle Holder	-	8" (20.3 cm)
8-53	CRILE-WOOD Needle Holder	-	9" (22.9 cm)
8-58	GILLIES-SHEEHAN Needle Holder with Suture Scissors	straight, one fenestrated jaw & one angled finger ring	6-1/2" (16.5 cm)
8-59	GILLIES-SHEEHAN Needle Holder with Suture Scissors	curved, one fenestrated jaw & one angled finger ring	6 1/2" (16.5 cm)



8-42 to 8-48



8-130



8-50 to 8-53



8-58
8-59

Needle Holders

REF	Description	Type	Length
8-70	ADSON Needle Holder	fenestrated jaws	7-1/4" (18.4 cm)
8-74	METZENBAUM Needle Holder	straight, fenestrated jaws	7-1/4" (18.4 cm)
8-76	METZENBAUM Needle Holder	curved, fenestrated jaws	7-1/4" (18.4 cm)
8-80	NEW ORLEANS Needle Holder	-	7" (17.8 cm)
8-84	M.G.H. Needle Holder	-	7" (17.8 cm)
8-94	CRILE Needle Holder	-	6" (15.2 cm)



8-70



8-74

8-76



8-80



8-84



8-94

Needle Holders

REF	Description	Type	Length
8-96	SAROT Needle Holder	light model	7-1/8" (18.1 cm)
8-114	SAROT Needle Holder	-	10-1/2" (26.7 cm)
8-100	HEANEY Needle Holder	curved jaws	8-1/2" (21.6 cm)
8-102	STRATTE Needle Holder	double curved jaws & bent shanks	9" (22.9 cm)

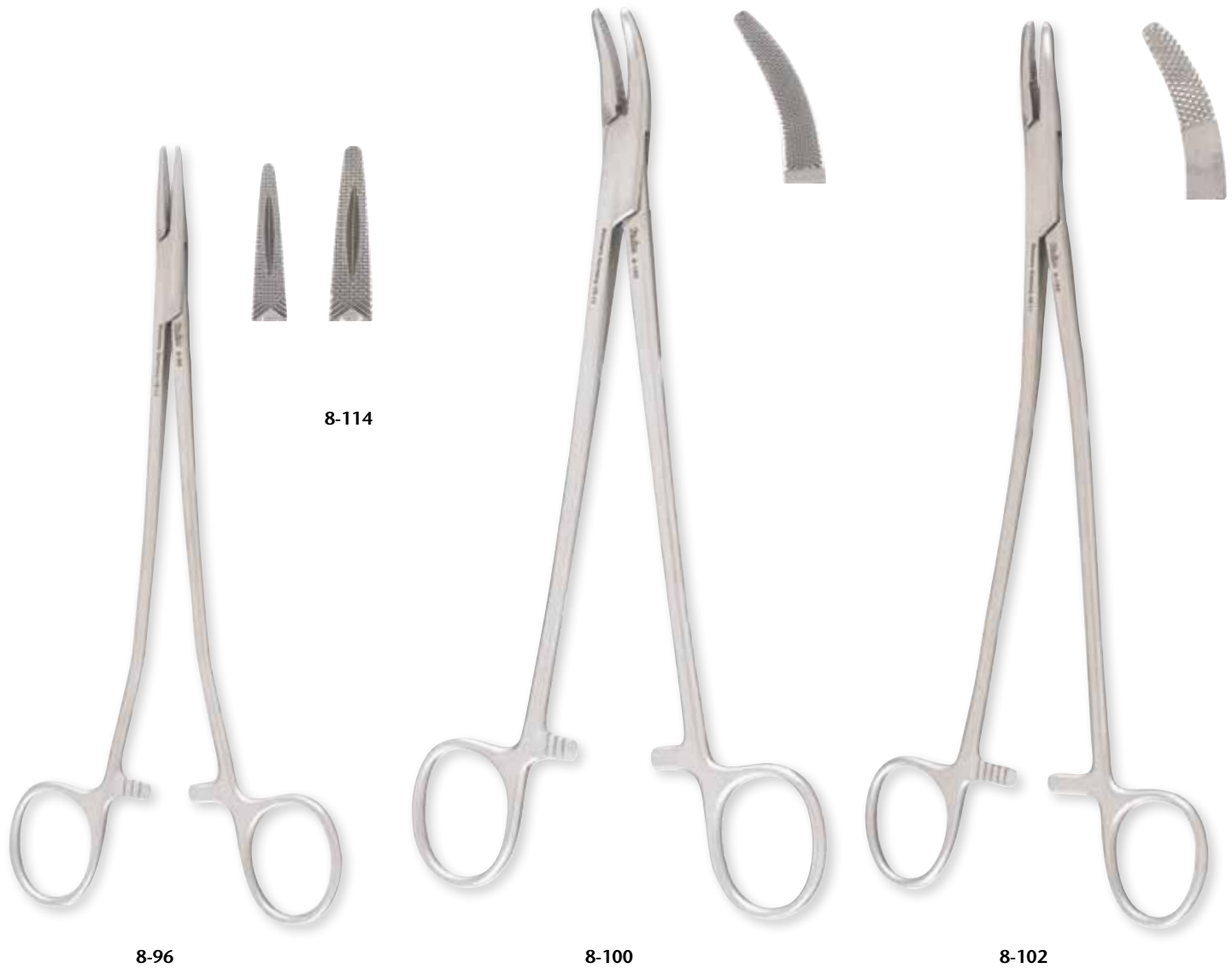

Needle Holders

REF	Description	Type	Length
8-122	FINOCHIETTO Needle Holder	angled jaws	10-1/2" (26.7 cm)
8-134	WANGENSTEEN Needle Holder	long jaws	10-3/4" (27.3 cm)
8-136	WANGENSTEEN Needle Holder	short jaws	10-1/2" (26.7 cm)

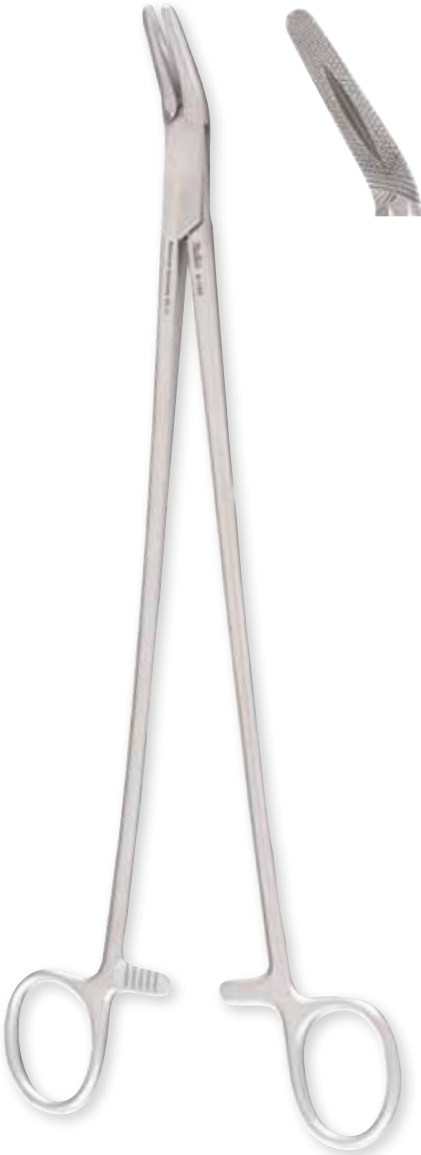

8-122



8-134

8-136

Microsurgical Needle Holders

REF	Description	Type	Length
17-1000	MILTEX Microsurgery Needle Holders	round handles, 0.6 mm tips, curved jaws	5-1/4" (13.3 cm)
17-980	MILTEX Microsurgery Needle Holders	round handles, 0.6 mm tips, straight jaws	7-1/8" (18.1 cm)
17-1010	MILTEX Microsurgery Needle Holders	round handles, 0.6 mm tips, curved jaws	7-1/8" (18.1 cm)
17-1020	MILTEX Microsurgery Needle Holders	round handles, 0.6 mm tips, curved jaws, with lock	5-1/4" (13.3 cm)
17-1024	MILTEX Microsurgery Needle Holders	round handles, 0.6 mm tips, straight jaws, with lock	7-1/8" (18.1 cm)
17-1025	MILTEX Microsurgery Needle Holders	round handles, 0.6 mm tips, curved jaws, with lock	7-1/8" (18.1 cm)



17-1000



17-980

17-1010



17-1020



17-1024

17-1025

Microsurgical Needle Holders

REF	Description	Type	Length
18-1800	KALT Needle Holder	convex jaws, fine serrations	5-1/4" (13.3 cm)
18-1810	GREEN Needle Holder & Suturing Forceps	convex jaws, fine serrations	6-3/4" (17.1 cm)
18-1820	CASTROVIEJO Needle Holder, smooth	straight without lock	5-1/2" (14 cm)
18-1824	CASTROVIEJO Needle Holder, smooth	curved without lock	5-1/2" (14 cm)
18-1828	CASTROVIEJO Needle Holder, smooth	straight with lock	5-1/2" (14 cm)
18-1832	CASTROVIEJO Needle Holder, smooth	curved with lock	5-1/2" (14 cm)
18-1831	CASTROVIEJO Needle Holder, smooth	straight, extra delicate jaws, with lock	5-1/2" (14 cm)
18-1833	CASTROVIEJO Needle Holder, smooth	curved, extra delicate jaws, with lock	5-1/2" (14 cm)



18-1800



18-1810



18-1820



18-1824



18-1828



18-1832



18-1831



18-1833

Microsurgical Needle Holders

REF	Description	Type	Length
18-1834	PATTON Needle Holder	straight without lock	4-1/2" (11.4 cm)
18-1837	McPHERSON Microsurgery Needle Holder	curved smooth tapered jaws with lock	4" (10.2 cm)
18-1838	BARRAQUER Needle Holder	curved, without lock, 10 mm wide hollow handles	5" (12.7 cm)
18-1839	BARRAQUER Needle Holder	curved, with lock, 10 mm wide hollow handles	5" (12.7 cm)
18-1840	BARRAQUER Needle Holder	curved, 8 mm wide solid round handle without lock	5-1/8" (13 cm)
18-1864	MCPHERSON Needle Holder	very delicate jaws, straight without lock	4 1/2" (11.4 cm)
18-1865	MCPHERSON Needle Holder	very delicate jaws, curved, without lock	4 1/2" (11.4 cm)
18-1866	MCPHERSON Needle Holder	very delicate jaws, straight with lock	4 1/2" (11.4 cm)
18-1867	MCPHERSON Needle Holder	very delicate jaws, curved, with lock	4 1/2" (11.4 cm)



18-1834



18-1837



18-1838
18-1839



18-1840

MILTEX® SUTURING

Clips & Accessories	128
Suture and Stitch Scissors.....	129-130
Pin & Wire Instrumentation	131
Ligature Carriers, Awls & Guides	132
Suture Wire	133
Surgical Needles.....	134-135



Clips & Accessories

REF	Description	Type	Length
9-1	MICHEL Wound Clips	stainless steel, 100/envelope, 1000/box	7.5 mm
9-2	MICHEL Wound Clips	stainless steel, 100/envelope, 1000/box	11 mm
9-4	MICHEL Wound Clips	stainless steel, 100/envelope, 1000/box	14 mm
9-6	MICHEL Wound Clips	stainless steel, 100/envelope, 1000/box	16 mm
9-8	MICHEL Wound Clips	stainless steel, 100/envelope, 1000/box	18 mm
9-10	MICHEL Wound Clips	stainless steel, 100/envelope, 1000/box	22 mm
9-32	MCKENZIE Brain Clip Holding Rack	for 20 Clips	-
9-50	MICHEL Clip Applying Forceps	-	4-3/4" (12.1 cm)
9-52	HEGENBARTH Clip Applying Forceps	cross action	4-3/4" (12.1 cm)
9-54	WACHENFELD Applying - Removing Forceps	cross action	4-3/4" (12.1 cm)
9-60	MICHEL Clip Applying - Removing Forceps	double ended	5" (12.7 cm)
9-62	MILTEX Skin Staple Removing Forceps	-	5-1/2" (14 cm)
9-90	SCOVILLE Clip Applying Forceps	6" shaft	6" (15.2 cm)
9-94	RICHTER-HEATH Clip Removing Forceps	-	5-1/2" (14 cm)

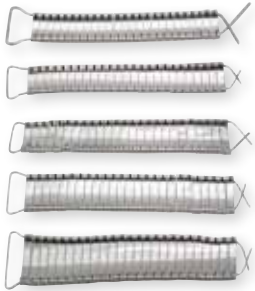

9-1 to
9-10



9-32



9-50



9-52



9-54



9-60



9-62



9-90



9-94

Suture Scissors

REF	Description	Type	Length
9-96	HEATH Suture Scissors	serrated blade	6-1/8" (15.4 cm)
9-98	NEW'S Suture Scissors	angled on flat	5-1/2" (14 cm)
18-1652	Eye Suture (GRADLE) Scissors	slightly curved, sharp	3-3/4" (9.5 cm)
18-1653*	Eye Suture Scissors	slightly curved, ribbon type, sharp	4" (10.2 cm)
21-536	LITTLER Suture Carrying Scissors	curved with suture hole in blades	4-5/8" (11.8 cm)
PM-6770**	LASCHAL Suture Scissors/Forceps	straight	4-1/2" (11.4 cm)
PM-6780**	LASCHAL Suture Cutter	straight	6" (15.2 cm)

*Ribbon type scissors have extra large finger rings

**  **PADGETT**
INSTRUMENTS® By *Miltex*



9-96



9-98



18-1652



18-1653



21-536



PM-6770



PM-6780

Stitch Scissors

REF	Description	Type	Length
9-100	SPENCER Stitch Scissors	delicate	3-1/2" (8.9 cm)
PM-6751**	SPENCER Stitch Scissors	curved on flat	3-1/2" (8.9 cm)
9-101	SHORTBENT Stitch Scissors	curved, delicate	3-1/2" (8.9 cm)
9-102	LITTAUER JR. Stitch Scissors	light pattern	4-1/2" (11.4 cm)
9-103	NORTHBENT Stitch Scissors	curved, light pattern	4-3/4" (12.1 cm)
9-104	LITTAUER Stitch Scissors	standard pattern	5-1/2" (14 cm)
9-106	LONG Oral Surgery Stitch Scissors	-	6" (15.2 cm)
9-108	MILTEX Stitch Scissors	angled, delicate	4-1/2" (11.4 cm)
9-110	O'BRIEN Stitch Scissors	angled, sharp points	3-3/4" (9.5 cm)
9-115*	REEH Stitch Scissors	ribbon type, sharp tips, small hook on 1 blade	3-3/4" (9.5 cm)
18-1486	WESTCOTT Stitch Scissors	curved, sharp point	4-1/2" (11.4 cm)

*Ribbon type scissors have extra large finger rings

**  **PADGETT** INSTRUMENTS® By *Miltex*



Pin & Wire Instrumentation

REF	Description	Type	Length
9-120	MILTEX Wire Cutting Scissors	straight, one serrated blade	4-3/4" (12.1 cm)
9D-121	MILTEX Wire Cutting Scissors	straight	4-3/4" (12.1 cm)
9-122	MILTEX Wire Cutting Scissors	curved, one serrated blade	4-3/4" (12.1 cm)
9D-123	MILTEX Wire Cutting Scissors	curved	4-3/4" (12.1 cm)
9D-132	MILTEX Wire Cutting Scissors	straight, one serrated blade	4-1/4" (10.8 cm)
9D-133	MILTEX Wire Cutting Scissors	straight	4-1/4" (10.8 cm)
9D-134	MILTEX Wire Cutting Scissors	curved, one serrated blade	4-1/4" (10.8 cm)
9D-135	MILTEX Wire Cutting Scissors	curved	4-1/4" (10.8 cm)
9-124	MILTEX Wire Cutting Scissors	angled to side, one serrated blade	4-3/4" (12.1 cm)
9-124TC	MILTEX Wire Cutting Scissors	angled to side, one serrated blade, Carb-N-Sert inserts	4-3/4" (12.1 cm)
9-128	Double Action Parallel Pliers & Wire Cutter	nickel plated	4-1/2" (11.4 cm)
22-500TC	Wire Twister	with blunt delicate Carb-N-Sert jaws	6" (15.2 cm)
22-502TC	Wire Twister	with blunt delicate Carb-N-Sert jaws	8" (20.3 cm)
27-176TC	MILTEX Pin Puller	Carb-N-Sert serrated top jaw (1 cm in length) grooved cross-serrated opposing jaw (1 cm in length)	5-1/2" (14 cm)
PM-2123*	CORWIN Wire Twister	tungsten carbide, serrated	6" (15.2 cm)

* **PADGETT**
INSTRUMENTS By *Millex*



Ligature Carriers, Awls & Guides

REF	Description	Type	Length
9-140	DESCHAMPS Ligature Carrier	blunt, left	8" (20.3 cm)
9-142	DESCHAMPS Ligature Carrier	blunt, right	8" (20.3 cm)
9-146	DESCHAMPS Ligature Carrier	sharp, left	8" (20.3 cm)
9-148	DESCHAMPS Ligature Carrier	sharp, right	8" (20.3 cm)
9-154	DUPUYS-WEISS Ligature Carrier	right	8-1/2" (21.6 cm)
9-156	DUPUYS-WEISS Ligature Carrier	left	8-1/2" (21.6 cm)
21-900	OBWEGESER Mandibular Awl for Wire Suturing	slightly curved	5-1/2" (14 cm)
21-901	OBWEGESER Maxillary Awl for Wire Suturing	strong curve	7" (17.8 cm)
21-902	OBWEGESER Zygomatic Arch Awl for Wire Suturing	sightly curved	9" (22.9 cm)
27-110	Bone Wire Guide	U.S. pattern	8-3/4" (22.2 cm)



9-140

9-142

9-146

9-148

9-154

9-156

21-900

21-901

21-902

27-110

Needle Rack & Stainless Steel Suture Wire

REF	Description	Gauge	Diameter	Length of spool
3-50	Sterilizer Spiral Rack for Surgical Needles	-	-	-
				1 oz.(28 g) spool
9-40-18	BABCOCK Stainless Steel Suture Wire	18	.040" (1 mm)	13 ft.
9-40-20	BABCOCK Stainless Steel Suture Wire	20	.032" (.8 mm)	20 ft.
9-40-22	BABCOCK Stainless Steel Suture Wire	22	.025" (.6 mm)	30 ft.
9-40-24	BABCOCK Stainless Steel Suture Wire	24	.020" (.5 mm)	45 ft.
9-40-25	BABCOCK Stainless Steel Suture Wire	25	.018" (.45 mm)	54 ft.
9-40-26	BABCOCK Stainless Steel Suture Wire	26	.016" (.4 mm)	72 ft.
9-40-28	BABCOCK Stainless Steel Suture Wire	28	.012" (.3 mm)	125 ft.
9-40-30	BABCOCK Stainless Steel Suture Wire	30	.010" (.25 mm)	180 ft.
9-40-32	BABCOCK Stainless Steel Suture Wire	32	.008" (.2 mm)	295 ft.
9-40-34	BABCOCK Stainless Steel Suture Wire	34	.006" (.15 mm)	500 ft.
9-40-36	BABCOCK Stainless Steel Suture Wire	36	.005" (.13 mm)	750 ft.
				4 oz. (113 g) spool
9-44-18	BABCOCK Stainless Steel Suture Wire	18	.040" (1 mm)	48 ft.
9-44-20	BABCOCK Stainless Steel Suture Wire	20	.032" (.8 mm)	75 ft.
9-44-22	BABCOCK Stainless Steel Suture Wire	22	.025" (.6 mm)	120 ft.
9-44-24	BABCOCK Stainless Steel Suture Wire	24	.020" (.5 mm)	184 ft.
9-44-25	BABCOCK Stainless Steel Suture Wire	25	.018" (.45 mm)	214 ft.
9-44-26	BABCOCK Stainless Steel Suture Wire	26	.016" (.4 mm)	285 ft.
9-44-28	BABCOCK Stainless Steel Suture Wire	28	.012" (.3 mm)	500 ft.
9-44-30	BABCOCK Stainless Steel Suture Wire	30	.010" (.25 mm)	675 ft.
9-44-32	BABCOCK Stainless Steel Suture Wire	32	.008" (.2 mm)	1200 ft.
9-44-34	BABCOCK Stainless Steel Suture Wire	34	.006" (.15 mm)	2030 ft.



3-50



9-40-24



9-44-24

Surgical Needles

Cutting edge needles have one or more honed cutting surfaces and are used to cut dense strong, organized tissues like skin, cartilage, tendons and ligaments.

Taper point needles taper to a point and are used to cut less dense tissues, such as blood vessels, which might leak after piercing. The circle description denotes the curved shape of the needle which is formed in an arc of 1/2 or 3/8 of a circle.

**When ordering, replace "#" symbol with the desired needle size.
All needles have regular eyes unless otherwise noted.
Needles are not shown actual size.
Needles are packed in packages of 12.*

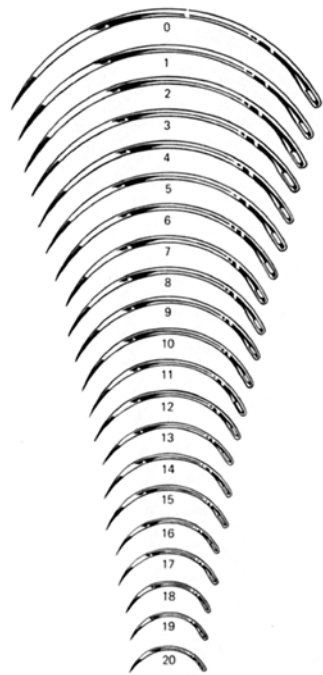

MS-140-#
REGULAR SURGEON'S
3/8 Circle
Reverse Cutting Edge

MS-140S-#
Same as above
with Spring Eye

MS-140A-#
REGULAR SURGEON'S
3/8 Circle
Taper Point

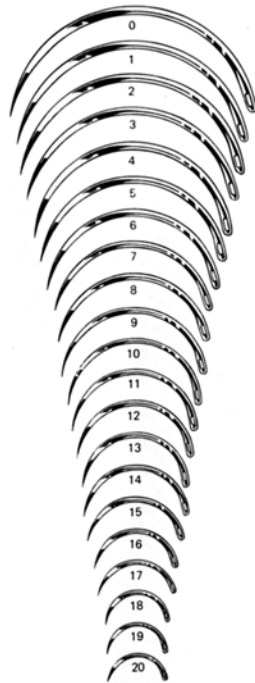

MS-192-#
REGULAR SURGEON'S
1/2 Circle
Cutting Edge

MS-192S-#
Same as Above
with Spring Eye

MS-192A-#
REGULAR SURGEON'S
1/2 Circle
Taper Point



MS-450-#
FISTULA
1/2 Circle
Cutting Edge

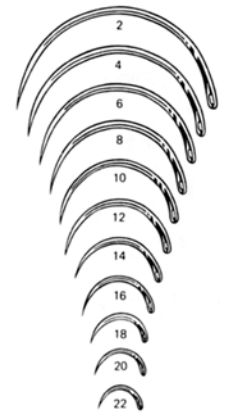

MS-126-#
FERGUSON
1/2 Circle
Taper Point



MS-141-#
REGULAR SURGEON'S
Half Curved
Cutting Edge



MS-150-#
ROUND BODIED
1/2 Circle
Taper Point



MS-153-#
MAYO INTESTINAL
3/8 Circle
Taper Point



MS-179-#
MURPHY'S INTESTINAL
1/2 Circle
Taper Point



MS-431-#
KEITH ABDOMINAL
Straight
Triangular Point



MS-117-#
MARTIN'S UTERINE
1/2 Circle
Cutting Edge

Surgical Needles

**When ordering, replace "#" symbol with the desired needle size.
All needles have regular eyes unless otherwise noted.
Needles are not shown actual size.
Needles are packed in packages of 12.*



MS-1274-#
LOOPUYT'S
Cutting Edge

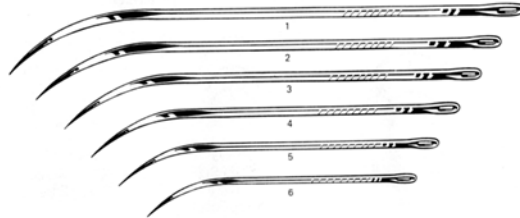

MS-1291-#
POST MORTEM
Half Curved
Cutting Edge

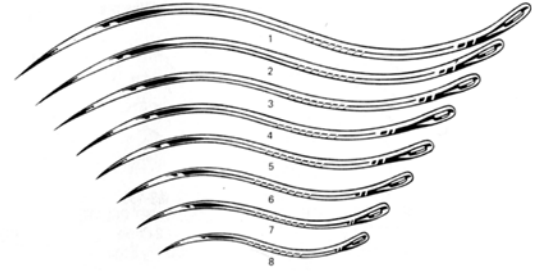

MS-1295-#
POST MORTEM
Double Curved
Cutting Edge

Veterinary Needles



MS-1282-#
VETERINARY
1/2 Circle
Cutting Edge



MS-1281-#
VETERINARY
3/8 Circle
Cutting Edge

Eye Needles



MS-172-#
EYE NEEDLE
3/8 Circle
Cutting Edge



MS-175-#
EYE NEEDLE
1/2 Circle
Cutting Edge



MS-177
JAMESON STRABISMUS
Cutting Edge



MS-176-#
EYE NEEDLE
1/2 Circle
Taper Point

Dental Needles



MS-155-#
LANE CLEFT PALATE
3/8 Circle
Cutting Edge



MS-156-#
LANE CLEFT PALATE
1/2 Circle
Cutting Edge



MSRC-14
MSRC-18
REGULAR SURGEON'S
1/2 Circle
Reverse Cutting Edge

MILTEX® RETRACTORS

Finger Held Retractors 137

 VOLKMAN and MEYERDING Retractor 137

Hand Held Retractors 138-143

 SENN Retractor 139

 Ribbon Retractor 140

 Langenbeck Retractor 141

 HOHMANN Retractor 142

 VOLKMANN Retractor 143

Self-Retaining Retractors 144-151

 Specula 144-145

 JANSEN Retractor 146

 ALM Retractor 147

 GELPI Retractor 148

 BALFOUR Retractor 149

 WEITLANER Retractor 150

 Badgley Retractor 151

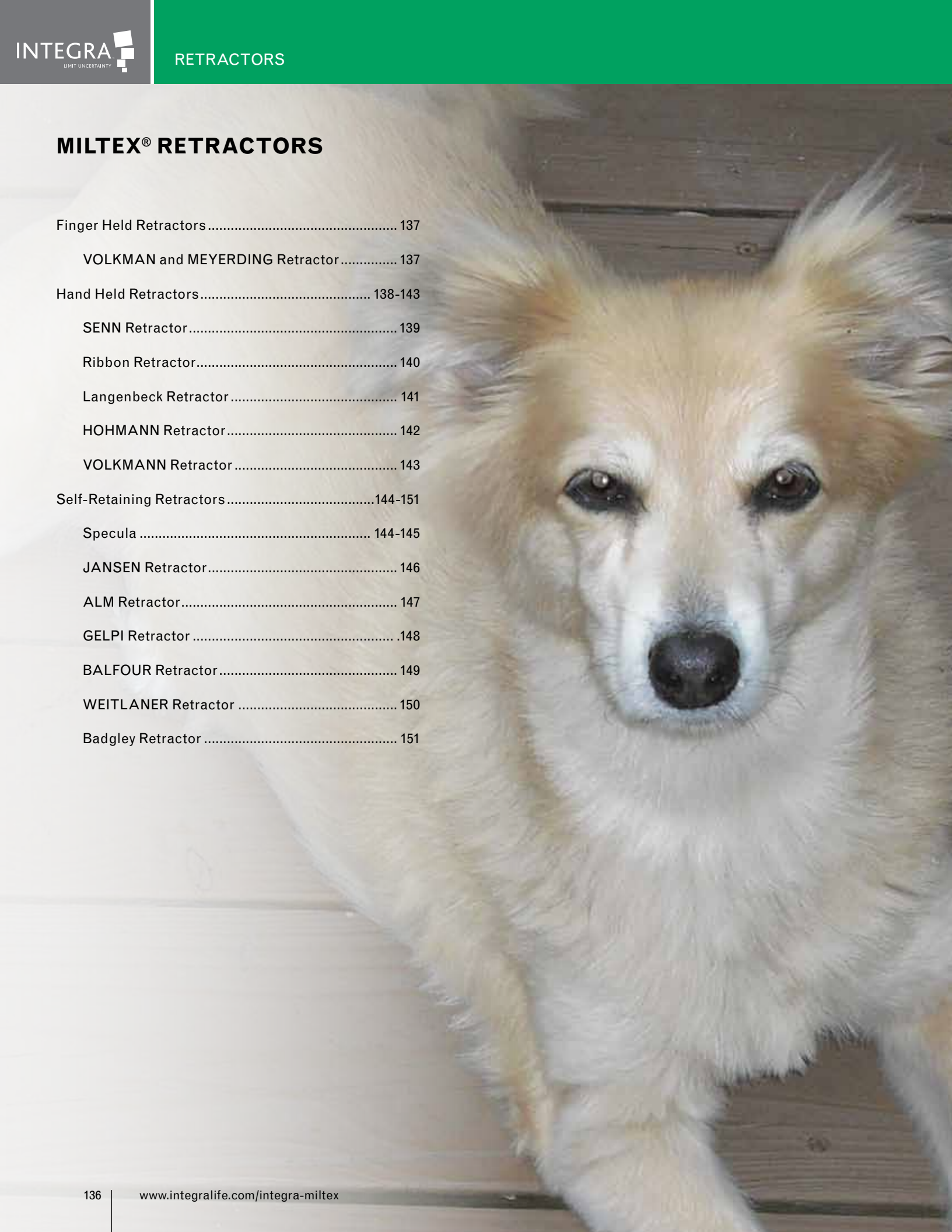

Finger Held Retractors

Retractors, also called "wound spreaders," are designed for spreading incisions. There are three basic groups of retractors: Finger Held, Hand Held and Self-Retaining.

REF	Description	Type	Length
11-42	VOLKMAN Finger Retractor	2 sharp prongs	4-1/2" (11.4 cm)
11-43	VOLKMAN Finger Retractor	3 sharp prongs	4-1/2" (11.4 cm)
11-44	VOLKMAN Finger Retractor	4 sharp prongs	4-1/2" (11.4 cm)
11-45	VOLKMAN Finger Retractor	6 sharp prongs	4-1/2" (11.4 cm)
11-46	VOLKMAN Finger Retractor	2 blunt prongs	4-1/2" (11.4 cm)
11-47	VOLKMAN Finger Retractor	3 blunt prongs	4-1/2" (11.4 cm)
11-48	VOLKMAN Finger Retractor	4 blunt prongs	4-1/2" (11.4 cm)
11-49	VOLKMAN Finger Retractor	6 blunt prongs	4-1/2" (11.4 cm)
11-88	MEYERDING Finger Retractor	style A, blade 1/4" (.64 cm) x 1 1/16" (1.7 cm)	7" (17.8 cm)
11-90	MEYERDING Finger Retractor	style B, blade 3/16" (.48 cm) x 5/8" (1.6 cm)	7" (17.8 cm)
11-92	MEYERDING Finger Retractor	style C, blade 1/8" (.32 cm) x 1/4" (.64 cm)	7" (17.8 cm)
11-94	MEYERDING Finger Retractor	style D, blade 3/32" (.24 cm) x 3/8" (1 cm)	7" (17.8 cm)
11-96	MEYERDING Finger Retractor	style E, blade 1/4" (.64 cm) x 7/8" (2.2 cm)	7" (17.8 cm)
21-107	MILLARD Thimble Hook Retractor	single sharp hook, 5/8" (1.6 cm) working length	-



11-42 to
11-49



11-88 to
11-96



21-107

Hand Held Retractors

REF	Description	Type	Length
11-30	Flexible Neck Rake Retractor	1 sharp prong	6" (15.2 cm)
11-32	Flexible Neck Rake Retractor	2 sharp prongs	6" (15.2 cm)
11-34	Flexible Neck Rake Retractor	3 sharp prongs	6" (15.2 cm)
11-36	Flexible Neck Rake Retractor	1 blunt prong	6" (15.2 cm)
11-38	Flexible Neck Rake Retractor	2 blunt prongs	6" (15.2 cm)
11-40	Flexible Neck Rake Retractor	3 blunt prongs	6" (15.2 cm)
11-50	Rigid Neck Rake Retractor	1 sharp prong	6-1/2" (16.5 cm)
11-52	Rigid Neck Rake Retractor	2 sharp prongs	6-1/2" (16.5 cm)
11-54	Rigid Neck Rake Retractor	3 sharp prongs	6-1/2" (16.5 cm)
11-56	Rigid Neck Rake Retractor	1 blunt prong	6-1/2" (16.5 cm)
11-58	Rigid Neck Rake Retractor	2 blunt prongs	6-1/2" (16.5 cm)
11-60	Rigid Neck Rake Retractor	3 blunt prongs	6-1/2" (16.5 cm)
18-100	KNAPP (ROLLET) Retractor	4 sharp prongs	5-1/4" (13.3 cm)
18-102	KNAPP Retractor	4 blunt prongs	5-1/4" (13.3 cm)
18-110	DESMARRES Retractor	size 1, 12 mm	5-1/2" (14 cm)
18-112	DESMARRES Retractor	size 2, 14 mm	5-1/2" (14 cm)
18-114	DESMARRES Retractor	size 3, 16 mm	5-1/2" (14 cm)
18-116	DESMARRES Retractor	size 4, 18 mm	5-1/2" (14 cm)
18-439	McGANNON Retractor	fenestrated blade 2.5 mm wide	5" (12.7 cm)



11-30 to
11-34

11-36 to
11-40

11-50 to
11-60

18-100

18-102

18-110 to
18-116

18-439

Hand Held Retractors

REF	Description	Type	Length
11-74	SENN Retractor	sharp, double end	6-3/8" (16.2 cm)
11-76	SENN Retractor	blunt, double end	6-3/8" (16.2 cm)
11-78	CRILE Retractor	double end 3 x 11 mm and 6 x 20 mm blades	4-1/2" (11.4 cm)
11-80	MATHIEU Retractor	sharp, double end	6-1/2" (16.5 cm)
11-81	MATHIEU Retractor	blunt, double end	6-1/2" (16.5 cm)
11-82	MEYERDING Skin Hook & Retractor	double end	6-1/4" (15.9 cm)
11-590	HIBBS Retractor	blade 1" (2.5 cm) x 3" (7.6 cm) deep	9-1/4" (23.5 cm)
21-150	COTTLE Retractor	4 blunt prongs, 2 center prongs recessed	5-1/2" (14 cm)



11-74

11-76

11-78

11-80
11-81

11-82

11-590

21-150

Hand Held Retractors

REF	Description	Type/Blade	Length
11-102	CUSHING Vein Retractor	blade 11 x 13 mm	9" (22.9 cm)
11-110	FARABEUZ Retractor	double end, set of 2	6" (15.2 cm)
11-112	Baby FARABEUZ Retractor	double end, set of 2	4-3/4" (12.1 cm)
11-114	PARKER Retractor	double end, set of 2	5" (12.7 cm)
11-116	PARKER Retractor	double end, set of 2	7-1/4" (18.4 cm)
11-120	GOELET Retractor	double end	7-1/2" (19.1 cm)
11-122	U.S. ARMY Retractor	double end, set of 2	8-1/2" (21.6 cm)
11-130	Ribbon Retractor	malleable, 3/4" (1.9 cm)	13" (33 cm)
11-132	Ribbon Retractor	malleable, 1" (2.5 cm)	13" (33 cm)
11-134	Ribbon Retractor	malleable, 1-1/4" (3.2 cm)	13" (33 cm)
11-136	Ribbon Retractor	malleable, 1-1/2" (3.8 cm)	13" (33 cm)
11-140	Ribbon Retractor	malleable, 2" (5.1 cm)	13" (33 cm)
11-144	Ribbon Retractor	petite, malleable, 5/8" (1.6 cm)	8" (20.3 cm)
11-146	Ribbon Retractor	petite, malleable, 1" (2.5 cm)	8" (20.3 cm)
PM-4205*	Ribbon Retractor	petite, delicate, malleable, 5/8" (1.6 cm)	6-3/4" (17.1 cm)
11-152	ROUX Retractor	double end, set of three	6-5/8" (16.8 cm)
11-153	ROUX Retractor	small, 3/4" (1.9 cm) x 1" (2.5 cm)	5-1/4" (13.3 cm)
11-154	ROUX Retractor	medium, 7/8" (2.2 cm) x 1-3/8" (3.5 cm)	5-3/4" (14.6 cm)
11-155	ROUX Retractor	large, 1" (2.5 cm) x 1-5/8" (4.1 cm)	6-5/8" (16.8 cm)

* **PADGETT** INSTRUMENTS. By *Miltex*



11-102

11-110
11-112

11-114
11-116

11-120

11-122

11-130 to
11-146
PM-1205

11-152

11-153 to
11-155

Hand Held Retractors

REF	Description	Type	Length
11-160	LANGENBECK Retractor	blade 3/8" (1 cm) x 1-1/4" (20.3 cm)	8-3/4" (22.2 cm)
11-162	LANGENBECK Retractor	blade 3/8" (1 cm) x 1-1/2" (3.8 cm)	8-1/2" (21.6 cm)
11-164	LANGENBECK Retractor	blade 1/2" (1.3 cm) x 1-1/2" (3.8 cm)	8-1/2" (21.6 cm)
11-166	LANGENBECK Retractor	blade 5/8" (1.6 cm) x 1-1/2" (3.8 cm)	8-1/2" (21.6 cm)
11-202	DEAVER Retractor	1" (2.5 cm)	12" (30.5 cm)
11-206	DEAVER Retractor	1-1/2" (3.8 cm)	12" (30.5 cm)
11-208	DEAVER Retractor	2" (5.1 cm)	12" (30.5 cm)
11-210	DEAVER Retractor	3" (7.6 cm)	12" (30.5 cm)
11-218	DEAVER Retractor	petite, 5/8" (1.6 cm)	8-1/2" (21.6 cm)
11-219	DEAVER Retractor	petite, 3/4" (1.9 cm)	7" (17.8 cm)
11-220	DEAVER Retractor	petite, 7/8" (2.2 cm)	8" (20.3 cm)
11-240	MEYERDING Retractor	large blade 3-1/2" (8.9 cm) x 2" (5.1 cm)	9-1/2" (24.1 cm)
11-242	MEYERDING Retractor	medium blade 3" (7.6 cm) x 1" (2.5 cm)	9-1/2" (24.1 cm)
11-244	MEYERDING Retractor	small blade 2" (5.1 cm) x 5/8" (1.6 cm)	9-1/2" (24.1 cm)
11-250	RICHARDSON Retractor	hollow grip handle, 1" (2.5 cm) x 3/4" (1.9 cm)	9-1/2" (24.1 cm)
11-252	RICHARDSON Retractor	hollow grip handle, 1-1/4" (3.2 cm) x 1" (2.5 cm)	9-1/2" (24.1 cm)
11-254	RICHARDSON Retractor	hollow grip handle, 1-1/2" (3.8 cm) x 1-1/2" (2.5 cm)	9-1/2" (24.1 cm)
11-256	RICHARDSON Retractor	hollow grip handle, 2" (5.1 cm) x 3/4" (1.9 cm)	9-1/2" (24.1 cm)



11-160 to
11-166

11-202 to
11-210

11-218 to
11-220

11-240 to
11-244

11-250 to
11-256

Hand Held Retractors

REF	Description	Type	Length
11-350	ISRAEL Retractor	blunt, 4 prongs, 1-3/4" (4.4 cm) x 1-5/8" (4.2 cm)	9-3/4" (24.8 cm)
11-352	ISRAEL Retractor	blunt, 6 prongs, 2-3/8" (6.0 cm) x 1-3/4" (4.4 cm)	10" (25.4 cm)
27-213	MINI-HOHMANN Retractor	blade 6 mm wide	6-1/4" (15.9 cm)
27-214	MINI-HOHMANN Retractor	blade 8 mm wide	6-1/4" (15.9 cm)
27-215	HOHMANN Retractor	blade 10 mm wide	9-1/4" (23.5 cm)
27-216	HOHMANN Retractor	blade 18 mm wide	9-1/4" (23.5 cm)
27-217	HOHMANN Retractor	blade 25 mm wide	9-1/4" (23.5 cm)
27-218	HOHMANN Retractor	blade 43 mm wide	9-1/4" (23.5 cm)
27-219	HOHMANN Retractor	blade 70 mm wide	9-3/4" (24.8 cm)
27-224	SMILLIE Meniscus Hook Retractor	blade 3/4" (1.9 cm) x 1-3/8" (3.5 cm)	5-3/4" (14.6 cm)
27-225	HAYS Hand & Finger Retractor	angled blade 1-1/2" (3.8 cm) long, tapering width 3/8" (1 cm) to 1/8" (.32 cm)	6" (15.2 cm)



11-350

11-352

27-213 to
27-214

27-215 to
27-217

27-218 to
27-219

27-224

27-225

Hand Held Retractors

REF	Description	Type	Length
11-504	VOLKMAN Retractor	2 prongs, sharp, hollow handle	8-1/2" (21.6 cm)
11-506	VOLKMAN Retractor	3 prongs, sharp, hollow handle	8-1/2" (21.6 cm)
11-508	VOLKMAN Retractor	4 prongs, sharp, hollow handle	8-1/2" (21.6 cm)
11-512	VOLKMAN Retractor	2 prongs, blunt, hollow handle	8-1/2" (21.6 cm)
11-514	VOLKMAN Retractor	3 prongs, blunt, hollow handle	8-1/2" (21.6 cm)
11-516	VOLKMAN Retractor	4 prongs, blunt, hollow handle	8-1/2" (21.6 cm)
11-530	VOLKMAN Retractor	2 prongs, sharp, ring handle	8-1/4" (21 cm)
11-532	VOLKMAN Retractor	3 prongs, sharp, ring handle	8-1/4" (21 cm)
11-534	VOLKMAN Retractor	4 prongs, sharp, ring handle	8-1/4" (21 cm)
11-536	VOLKMAN Retractor	6 prongs, sharp, ring handle	8-1/4" (21 cm)
11-538	VOLKMAN Retractor	2 prongs, blunt, ring handle	8-1/4" (21 cm)
11-540	VOLKMAN Retractor	3 prongs, blunt, ring handle	8-1/4" (21 cm)
11-542	VOLKMAN Retractor	4 prongs, blunt, ring handle	8-1/4" (21 cm)
11-544	VOLKMAN Retractor	6 prongs, blunt, ring handle	8-1/4" (21 cm)



11-504 to
11-516



11-530 to
11-544

Self-Retaining Retractors

REF	Description	Type	Length
18-2	LANCASTER Eye Speculum	blades 15 x 5 mm	3-1/4" (8.3 cm)
18-4	KNAPP Eye Speculum	blades 15 x 6 mm	3-1/4" (8.3 cm)
18-10	CASTROVIEJO Eye Speculum	large blades 18 x 5 mm O.D.	4" (10.2 cm)
18-12	CASTROVIEJO Eye Speculum	medium blades 15 x 5 mm O.D.	3-3/4" (9.5 cm)
18-22	WILLIAMS Eye Speculum	large blades 15 x 5 mm	3-1/4" (8.3 cm)
18-24	WILLIAMS Eye Speculum	small blades 11 x 5 mm	2-3/4" (7 cm)
18-33	MAUMENEE-PARK Eye Speculum	solid blades 14 mm wide, with lock screws	3-1/4" (8.3 cm)
18-34	Plain Wire Eye Speculum	blades 15 mm wide	2-1/2" (6.4 cm)



18-2



18-4



18-10



18-22
18-24



18-33



18-34

Self-Retaining Retractors

REF	Description	Type	Length
18-35	BARRAQUER Eye Speculum	large blades 15 mm wide	1-3/4" (4.4 cm)
18-36	BARRAQUER Eye Speculum	small blades 10 mm wide	1-3/4" (4.4 cm)
18-40	FEASTER Wire Speculum	extra large solid blades	1-1/2" (3.8 cm)
18-44	TEMPORAL APPROACH Wire Speculum	spring on nasal side, open wire	1-1/2" (3.8 cm)
18-45	TEMPORAL APPROACH Wire Speculum	spring on nasal side, closed wire	1-1/2" (3.8 cm)
18-46	TEMPORAL APPROACH Wire Speculum	spring on nasal side, solid blades	1-1/2" (3.8 cm)
18-47	SAUER Eye Speculum	petite size, blades 10 mm wide	1-1/4" (3.2 cm)
18-50	MURDOCK Eye Speculum	blades 15 mm wide, chrome	2-1/4" (5.7 cm)
18-63	COOK Eye Speculum	petite size, 9 mm blades	1-7/8" (4.7 cm)
18-64	COOK Eye Speculum	small size, 11 mm blades	1-7/8" (4.7 cm)
18-66	MELLINGER Eye Speculum	solid blades 15 mm wide	2-3/4" (7 cm)
18-68	MELLINGER Eye Speculum	fenestrated blades 15 mm wide	2-3/4" (7 cm)



18-35
18-36



18-40



18-44 to
18-46



18-47



18-50



18-63
18-64



18-66
18-68

Self-Retaining Retractors

REF	Description	Type	Length
18-80	AGRICOLA Lacrimal Sac Retractor	3 x 3 pointed prongs 4 mm deep	1-1/2" (3.8 cm)
18-84	MELLER Lacrimal Sac Retractor	3 x 3 prongs 3 mm deep, sharp-pointed prongs	2-7/8" (7.3 cm)
18-88	GOLDSTEIN Lacrimal Sac Retractor	3 x 3 pointed prongs 5 mm deep	1-1/8" (2.8 cm)
18-96	STEVENSON Lacrimal Sac Retractor	3 x 3 prongs, 3 mm deep	3-1/4" (8.3 cm)
11-2	JANSEN Retractor	spread 3" (7.6 cm), 3 x 3 blunt prongs 10 mm deep, standard model	4-1/4" (10.8 cm)
11-4	JANSEN Retractor	spread 3" (7.6 cm), 4 x 4 blunt prongs 20 mm deep	4-1/2" (11.4 cm)



18-80



18-84



18-88



18-96



11-2



11-4

Self-Retaining Retractors

REF	Description	Type	Length
11-6	ALLPORT Retractor	spread 2-1/2" (6.4 cm), 4 x 4 sharp prongs	4" (10.2 cm)
11-8	JANSEN-WAGNER Retractor	5 x 5 sharp prongs, self-adjusting	5" (12.7 cm)
11-10	DAVIS Retractor	3 x 3 blunt prongs	4-1/2" (11.4 cm)
11-12	ALM Retractor	spread 2-1/4" (5.7 cm), prongs 1/8" (.32cm) deep	2-3/4" (7 cm)
11-13	ALM Retractor	spread 3" (7.6 cm), prongs 1/2"(1.3 cm) deep	3-7/8" (9.8 cm)
11-14	MILTEX Cross Action Retractor	sharp prongs	4" (10.2 cm)
11-16	MILTEX Cross Action Retractor	blunt prongs	4" (10.2 cm)
11-19	Spring Wire Retractor	blades 11 mm wide x 15 mm deep	3-1/4" (8.3 cm)



11-6



11-8



11-10



11-12
11-13



11-14
11-16



11-19

Self-Retaining Retractors

REF	Description	Type	Length
MH11-364	Mini GELPI Retractor	grip lock, mini	3-1/2" (8.9 cm)
11-365	Petite GELPI Retractor	grip lock	5" (12.7 cm)
11-366	GELPI Retractor	grip lock	6-3/4" (17.1 cm)
11-368	GELPI Retractor	ball stops and grip lock	6-3/4" (17.1 cm)
11-374	RIGBY Appendectomy Retractor	grip lock	6-3/4" (17.1 cm)
11-400	GOSSET Retractor	1-1/8" (2.8 cm) x 1-1/2" (3.8 cm) blades	4" (10.2 cm) spread
11-402	GOSSET Retractor	1-1/8" (2.8 cm) x 2-1/2" (6.4 cm) blades	5-1/2" (14 cm) spread
11-404	PETITE GOSSET Retractor	3/4" (1.9 cm) x 1" (2.5 cm) blades, light pattern	3-1/2" (8.9 cm) spread



MH11-364
11-365



11-366



11-368



11-374

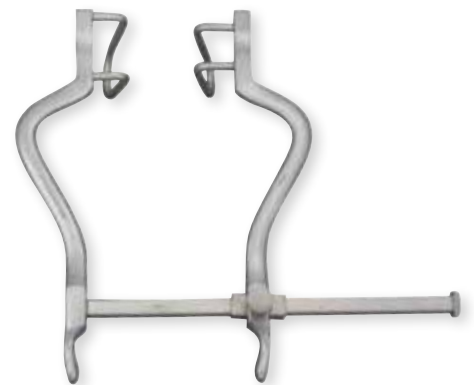

11-400 to
11-404

Self-Retaining Retractors

REF	Description	Type	Length
11-420	BALFOUR Abdominal Retractor	fenestrated side blades 2-1/2" (6.4 cm) deep & solid center blade 3" (7.6 cm) x 1-3/4" (4.4 cm) deep, standard size	7" (17.8 cm) spread
11-421	BALFOUR Abdominal Retractor	fenestrated side blades 2-1/2" (6.4 cm) deep & solid center blade 3" (7.6 cm) x 1-3/4" (4.4 cm) deep	10" (25.4 cm) spread
11-424	BALFOUR Abdominal Retractor	solid side blades 2-3/4" (7 cm) deep & solid center blade 3" (7.6 cm) x 1-3/4" (4.4 cm) deep	7" (17.8 cm) spread
11-428	BALFOUR Abdominal Retractor	fenestrated side blades 4" (10.2 cm) deep & solid center blade 2-3/4" (7 cm) x 4" (10.2 cm) deep	7" (17.8 cm) spread
11-430	Petite BALFOUR Abdominal Retractor	fenestrated side blades & solid center blade 1" (2.5 cm) deep, light pattern	4" (10.2 cm) spread
11-432	BALFOUR Abdominal Retractor	ratchet bar, 2 pair interchangeable fenestrated side blades 2-1/4" (5.7 cm) & 3-1/2" (8.9 cm) deep & 2 solid center blades 2-5/8" (6.7 cm) x 1-3/4" (4.4 cm) & 3-1/4" (8.3 cm) x 2-3/4" (7 cm) deep	7" (17.8 cm) spread
11-440	BALFOUR Center Blade	standard size 1-3/4" (4.4 cm) deep x 3" (7.6 cm) wide	11-1/4" (28.5 cm)
11-442	BALFOUR Center Blade	extra deep model, 4" (10.2 cm) deep x 2-3/4" (7 cm) wide	11-1/4" (28.5 cm)
11-444	BALFOUR Center Blade	1-3/4" (4.4 cm) deep x 2-5/8" (6.7 cm) wide	10" (25.4 cm)
11-446	BALFOUR Center Blade	2-3/4" (7 cm) deep x 3-1/4" (8.3 cm) wide	11" (27.9 cm)
11-448	BALFOUR Center Blade	5" (12.7 cm) deep, malleable x 2" (5.1 cm) wide	12" (30.4 cm)

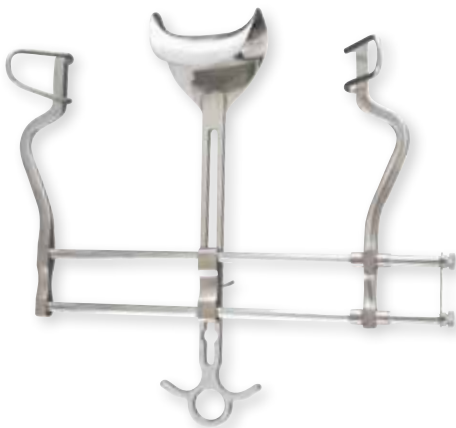

11-420
11-421



11-424



11-428



11-430



11-432



11-440
11-444
11-446



11-442



11-448

Self-Retaining Retractors

REF	Description	Type	Length
11-600	WEITLANER Retractor	sharp, 2 x 3 teeth	4-3/8" (11.1 cm)
11-602	WEITLANER Retractor	blunt, 2 x 3 teeth	4-3/8" (11.1 cm)
11-608	WEITLANER Retractor	sharp, 3 x 4 teeth	5-1/2" (14 cm)
11-610	WEITLANER Retractor	blunt, 3 x 4 teeth	5-1/2" (14 cm)
11-611	WEITLANER Retractor	solid blades	5-1/2" (14 cm)
11-614	WEITLANER Retractor	sharp, 3 x 4 teeth	6-1/2" (16.5 cm)
11-616	WEITLANER Retractor	blunt, 3 x 4 teeth	6-1/2" (16.5 cm)
11-617	WEITLANER Retractor	sharp, 3 x 4 teeth	8" (20.3 cm)
11-618	WEITLANER Retractor	blunt, 3 x 4 teeth	8" (20.3 cm)
11-620	WEITLANER Retractor	sharp, 3 x 4 teeth	9-1/2" (24.1 cm)
11-622	WEITLANER Retractor	blunt, 3 x 4 teeth	9-1/2" (24.1 cm)
11-625	PAPARELLA-WEITLANER Retractor	3.3 cm inside spread, 2 x 2 semi sharp teeth, prongs self-retaining, 13 mm long	5-7/64" (13 cm)
11-630-BL	BECKMAN-WEITLANER Retractor	blunt, 3 x 4 teeth, with hinge blades	5-1/2" (14 cm)
11-630-SH	BECKMAN-WEITLANER Retractor	sharp, 3 x 4 teeth, with hinge blades	5-1/2" (14 cm)
11-634-BL	BECKMAN-WEITLANER Retractor	blunt, 3 x 4 teeth, with hinge blades	6-1/2" (16.5 cm)
11-634-SH	BECKMAN-WEITLANER Retractor	sharp, 3 x 4 teeth, with hinge blades	6-1/2" (16.5 cm)
11-642-BL	BECKMAN-WEITLANER Retractor	blunt, 3 x 4 teeth, with hinge blades	9-1/2" (24.1 cm)
11-642-SH	BECKMAN-WEITLANER Retractor	sharp, 3 x 4 teeth, with hinge blades	9-1/2" (24.1 cm)
11-650	MEYERDING Retractor	self-retaining, 1" (2.5 cm) x 2-3/8" (6.1 cm) blades	-
11-652	MEYERDING Retractor	self-retaining, 1" (2.5 cm) x 2-1/8" (5.4 cm) blades	-
11-654	MEYERDING Retractor	self-retaining, 1" (2.5 cm) x 1-3/4" (4.4 cm) blades	-
11-656	MEYERDING Retractor	self-retaining, 3/4" (1.9 cm) x 2-3/8" (6.1 cm) blades	-

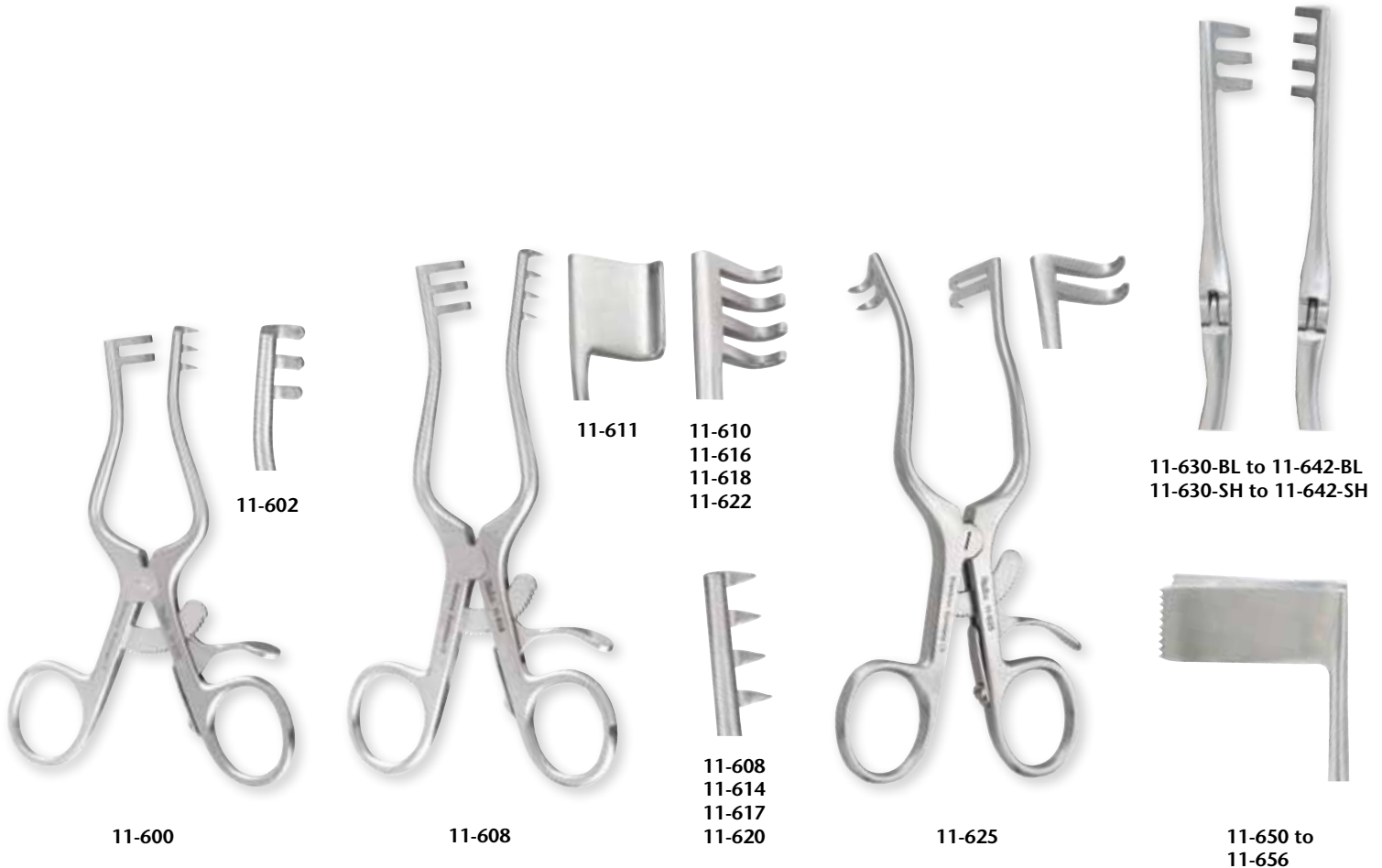

Self-Retaining Retractors

REF	Description	Type	Length
40-1235	SCHINK Metatarsal Spreader	-	4-1/2" (11.4 cm)
11-672	BADGLEY Retractor	4 x 4 blunt teeth, 2" (5.1 cm) x 1-3/4" (4.4 cm)	6-1/2" (16.5 cm) spread
11-676	TUFFIER Retractor	grooved blade 2" (5.1 cm) x 1-3/4" (4.4 cm)	6-1/2" (16.5 cm) spread



40-1235



11-672



11-676

MILTEX® HOOKS

WIENER Corneal Hook.....	153
DAY Ear Hook.....	153
COTTLE Double Hook.....	154
JOSEPH Double Hook.....	155
MILTEX® Tissue Hook.....	155
DANDY Nerve Hook	156
FRAZIER Dura Hook.....	156
VOLKMAN Hook.....	157

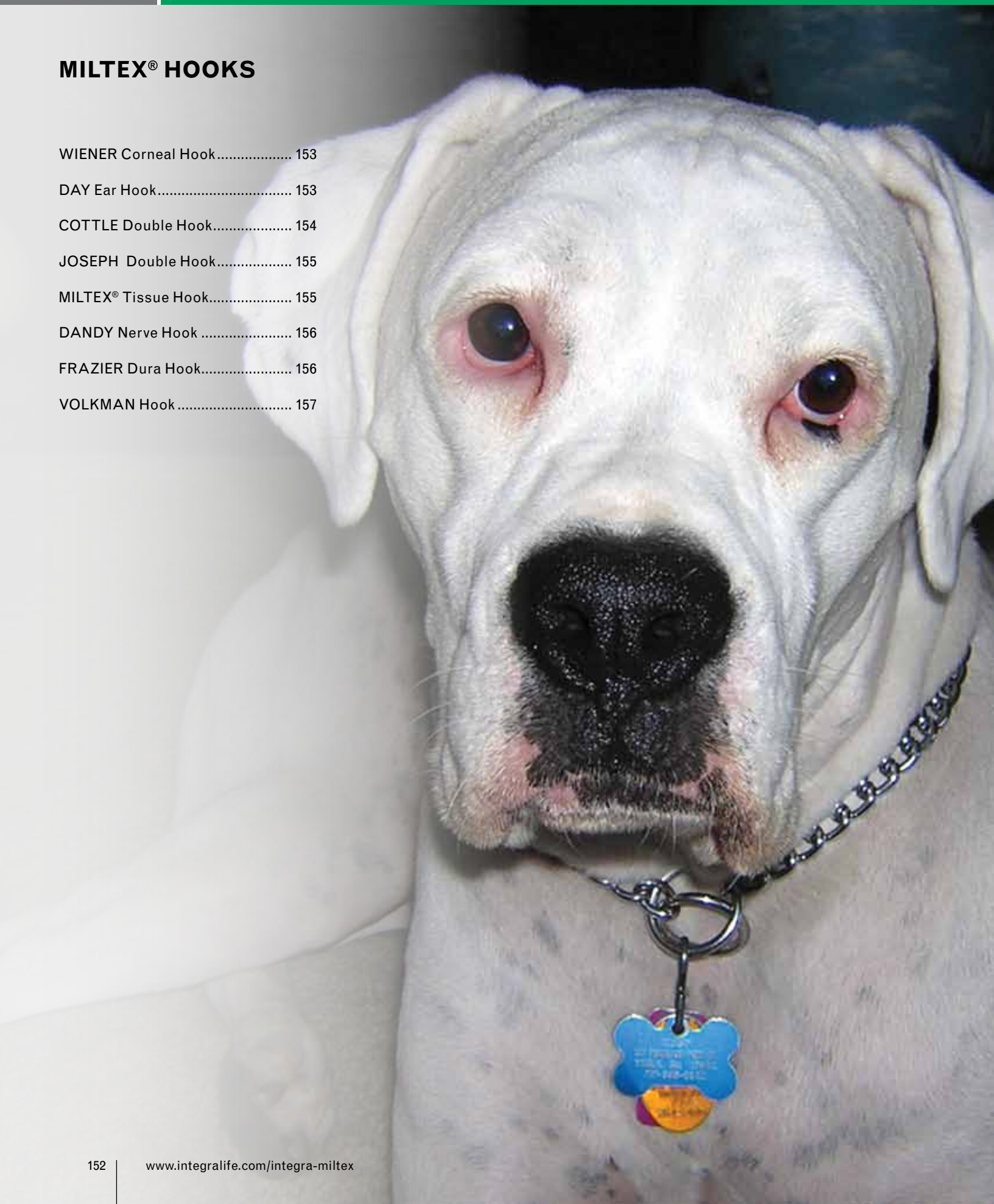

Hooks

REF	Description	Feature	Length
11-82	MEYERDING Skin Hook & Retractor	double end	6-1/4" (15.9 cm)
18-412	TYRELL Hook	sharp	5" (12.7 cm)
18-414	TYRELL Hook	blunt	5" (12.7 cm)
18-416	GUTHRIE Fixation Hook	sharp double prongs, 1.5 mm wide	5" (12.7 cm)
18-420	WIENER Corneal Hook	blunt	5" (12.7 cm)
18-418	WIENER Corneal Hook	sharp	5" (12.7 cm)
18-450	VON GRAEFE Strabismus Hook	small size 8 mm long	5-1/4" (13.3 cm)
18-452	VON GRAEFE Strabismus Hook	medium size 10 mm long	5-1/2" (14 cm)
18-454	VON GRAEFE Strabismus Hook	large size 11 mm long	5-3/4" (14.6 cm)
19-220	DAY Ear Hook	small size	6-1/2" (16.5 cm)
19-222	DAY Ear Hook	large size	6-1/2" (16.5 cm)

Tips enlarged to show detail



Hooks

REF	Description	Feature	Length
19-226	ALLPORT Mastoid Searcher	with ball tip	6-1/2" (16.5 cm)
19-228	GROSS Ear Hook & Spoon	double end	5" (12.7 cm)
21-88	GILLIES (CONVERSE) Skin Hook	large	7" (17.8 cm)
21-89	GILLIES (CONVERSE) Skin Hook	small	7" (17.8 cm)
21-102	FREER Skin Hook	sharp double prongs, 2.5 mm wide	6" (15.2 cm)
21-103	FREER Skin Hook	blunt double prongs, 2.5 mm wide	6" (15.2 cm)
21-144	COTTLE Double Hook	two sharp prongs, 12 mm wide	5-1/2" (14 cm)
21-152	MILTEX Skin Hook	sharp prong, 2 mm diameter	4-3/4" (12.1 cm)

Tips enlarged to show detail

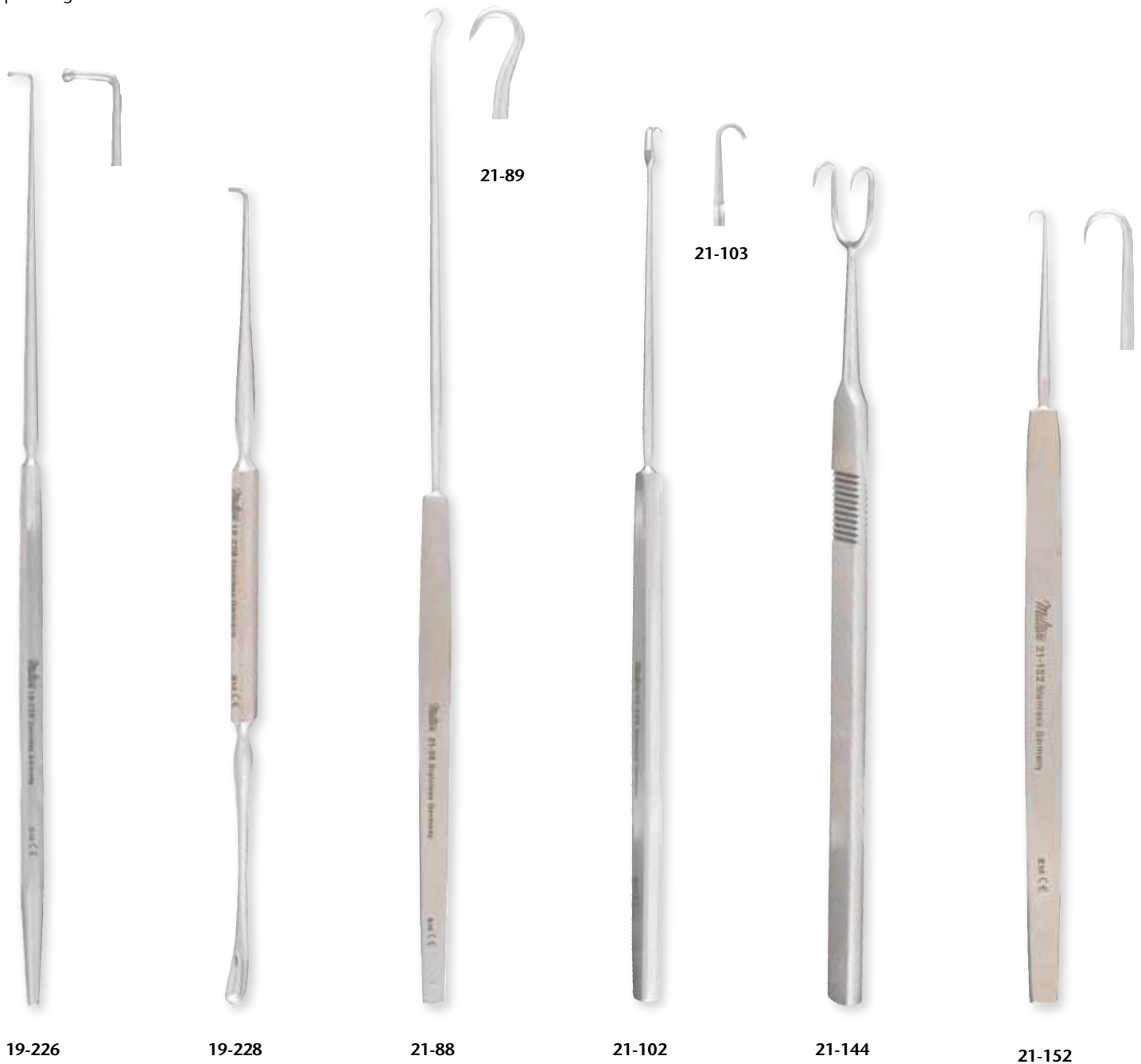

Hooks

REF	Description	Feature	Length
21-153	JOSEPH Hook	one sharp prong	6-1/4" (15.9 cm)
21-154	JOSEPH Double Hook	two sharp prongs, 2 mm wide	6-1/4" (15.9 cm)
21-156	JOSEPH Double Hook	two sharp prongs, 5 mm wide	6-1/4" (15.9 cm)
21-158	JOSEPH Double Hook	two sharp prongs, 7 mm wide	6-1/4" (15.9 cm)
21-160	JOSEPH Double Hook	two sharp prongs, 10 mm wide	6-1/4" (15.9 cm)
21-430	MILTEX Tissue Twist Hook	-	5-1/2" (14 cm)
23-1048	HUPP Hook	sharp point	6-1/2" (16.5 cm)
23-1051	NEWS Hook	single sharp prong	6" (15.2 cm)

Tips enlarged to show detail



21-153



21-154 to
21-160



21-430



23-1048



23-1051

Hooks

REF	Description	Feature	Length
26-1080	CUSHING Dura Hook	blunt	6-1/2" (16.5 cm)
26-1084	FRAZIER Dura Hook	sharp point	5" (12.7 cm)
26-1086	FRAZIER Dura Hook	blunt point	5" (12.7 cm)
26-1090	ADSON Dura & Dissecting Hook	sharp blade, 5 mm hook at right angle	8" (20.3 cm)
26-1092	ADSON Dura Hook	blunt blade, 5 mm hook at right angle	8" (20.3 cm)
26-1150	DANDY Nerve Hook	straight	9" (22.9 cm)
26-1156	GRAHAM Nerve Hook	blunt, 6 mm deep	6-1/2" (16.5 cm)
26-1170	SMITHWICK Nerve Hook	blunt, 10 mm deep	7" (17.8 cm)

Tips enlarged to show detail



Hooks

REF	Description	Feature	Length
11-500	VOLKMAN Hook	sharp, hollow handle	8-1/2" (21.6 cm)
11-502	VOLKMAN Hook	sharp, ring handle	8-1/2" (21.6 cm)
27-230	VOLKMAN Hook Retractor	sharp tip, 15 mm deep, ring handle	9" (22.9 cm)
27-232	VOLKMAN Hook Retractor	blunt tip, 15 mm deep, ring handle	9" (22.9 cm)
28-131	ROSSER Crypt Hook	blunt tip, ring handle	6-3/4" (17.1 cm)

Tips enlarged to show detail



11-500



11-502



27-230



27-232



28-131

MILTEX® RASPS & BONE FILES

Premium Rasps	159-161
COTTLE Rasps.....	161
AUFRICHT GLABELLA Rasp	162
FOMON Rasps.....	163
Bone Files	164



Rasps & Bone Files

When compared to traditional stainless steel patterns, Miltex® Carb-N-Sert® instruments offer long-term savings due to extended service life and higher resistance to wear.

ANATOMY OF MILTEX® RASPS & BONE FILES

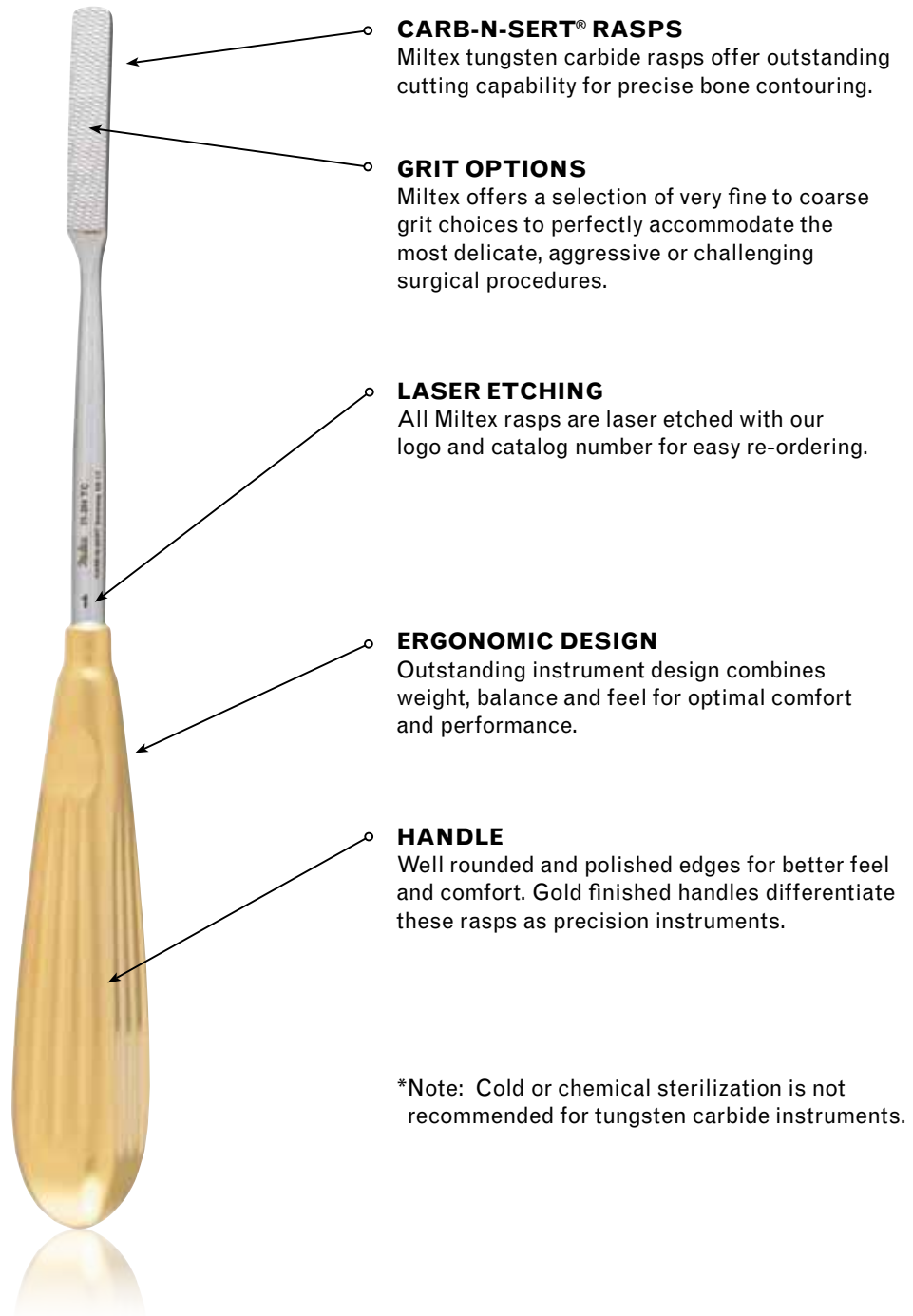

CARB-N-SERT® RASPS

Miltex tungsten carbide rasps offer outstanding cutting capability for precise bone contouring.

GRIT OPTIONS

Miltex offers a selection of very fine to coarse grit choices to perfectly accommodate the most delicate, aggressive or challenging surgical procedures.

LASER ETCHING

All Miltex rasps are laser etched with our logo and catalog number for easy re-ordering.

ERGONOMIC DESIGN

Outstanding instrument design combines weight, balance and feel for optimal comfort and performance.

HANDLE

Well rounded and polished edges for better feel and comfort. Gold finished handles differentiate these rasps as precision instruments.

*Note: Cold or chemical sterilization is not recommended for tungsten carbide instruments.

Rasps & Bone Files

REF	Description	Style	Tip	Type	Length
21-380TC	FOMON Rasp	double-ended, flat, backward cutting	No. 1 Very Fine and No. 2 Fine grit	Carb-N-Sert	8-1/4" (21 cm)
21-381TC	FOMON Rasp	double-ended, flat, backward cutting	No. 3 Fine and No. 4 Coarse grit	Carb-N-Sert	8-1/4" (21 cm)
21-382TC	FOMON Rasp	double-ended, flat, backward cutting	No. 5 Coarse and No. 6 Coarse grit	Carb-N-Sert	8-1/4" (21 cm)
21-383TC	FOMON Rasp	double-ended, flat, backward cutting	No. 7 Coarse and No. 8 Very Coarse grit	Carb-N-Sert	8-1/4" (21 cm)
21-384TC	PARKES Rasp	single-ended, backward cutting	No. 1 Very Fine grit	Carb-N-Sert	8-1/2" (21.6 cm)
21-385TC	PARKES Rasp	single-ended, backward cutting	No. 2 Fine Grit	Carb-N-Sert	8-1/2" (21.6 cm)
21-386TC	PARKES Rasp	single-ended, backward cutting	No. 3 Fine grit	Carb-N-Sert	8-1/2" (21.6 cm)
21-387TC	PARKES Rasp	single-ended, backward cutting	No. 4 Coarse grit	Carb-N-Sert	8-1/2" (21.6 cm)
21-388TC	PARKES Rasp	single-ended, backward cutting	No. 5 Coarse grit	Carb-N-Sert	8-1/2" (21.6 cm)
21-389TC	PARKES Rasp	single-ended, backward cutting	No. 6 Coarse grit	Carb-N-Sert	8-1/2" (21.6 cm)
21-390TC	PARKES Rasp	single-ended, backward cutting	No. 7 Coarse grit	Carb-N-Sert	8-1/2" (21.6 cm)
21-391TC	PARKES Rasp	single-ended, backward cutting	No. 8 Very Coarse grit	Carb-N-Sert	8-1/2" (21.6 cm)

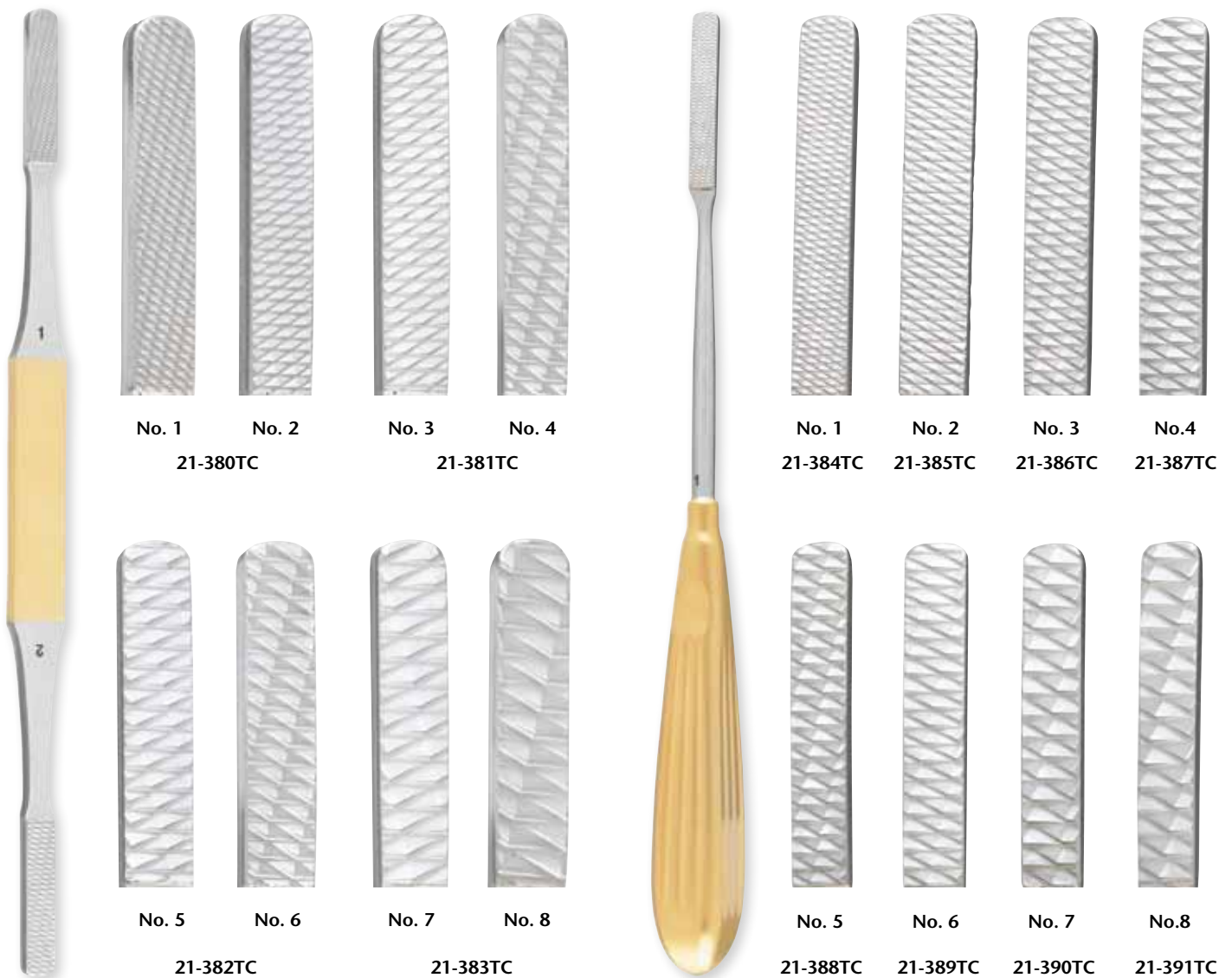

Rasps & Bone Files

REF	Description	Style	Tip	Type	Length
21-392DC	PEET (COTTLE) Rasp	finishing rasp	Straight	Diamond Coated	7-1/2" (19 cm)
21-393DC	PEET (COTTLE) Rasp	finishing rasp	Curved	Diamond Coated	7-1/2" (19 cm)
21-394TC	GLABELLA Rasp	backward cutting	No. 3 Fine grit, 5.5 mm x 10 mm radius tip	Carb-N-Sert	8-1/4" (21 cm)



21-392DC

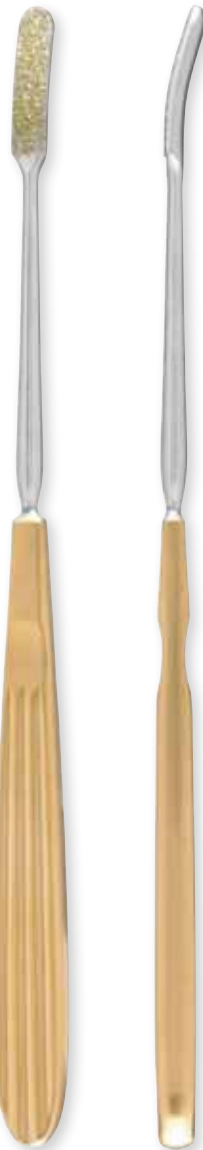

21-393DC



21-394TC

Rasps & Bone Files

REF	Description	Type	Length
21-330	JOSEPH Rasp	fine cross serrations	6-1/4" (15.9 cm)
21-338	COTTLE Rasp	backward cutting	8" (20.3 cm)
21-342	MALTZ Nasal Rasp	backward cutting	7" (17.8 cm)
21-343	MALTZ Rasp	improved double end pattern, forward & backward cutting	8-1/4" (21 cm)
21-346	AUFRICHT GLABELLA Rasp	curved blade, forward cutting	7-1/8" (18.1 cm)
21-348	AUFRICHT GLABELLA Rasp	curved blade, backward cutting	7-1/8" (18.1 cm)
21-352	LEWIS Nasal Rasp	fine teeth, backward cutting	7-1/2" (19.1 cm)
21-354	LEWIS Nasal Rasp	coarse teeth, backward cutting	7-1/2" (19.1 cm)



21-330

21-338

21-342

21-343

21-346
21-348

21-352

21-354

Rasps & Bone Files

REF	Description	Type	Length
21-360	GALLAHER Rasp	straight, coarse teeth	6-1/2" (16.5 cm)
21-368	FOMON Rasp	double ended, 4-sided, fine & coarse, flat & convex	8-1/4" (21 cm)
21-369	FOMON Rasp	double ended, coarse teeth, flat & convex	8-1/4" (21 cm)
21-370	FOMON Rasp	double ended, fine teeth, flat & convex	8-1/4" (21 cm)
27-700	PUTTI Bone Rasp	flat ends, one side curved on flat, other side curved sideways	10-1/2" (26.7 cm)
27-702	PUTTI Bone Rasp	round and half-round tapered curved ends	12" (30.5 cm)
27-703	Bone File	bayonet shank, half-round blade 3-1/2" (8.9 cm) x 1/2" (1.3 cm)	9-3/4" (24.8 cm)



21-360

21-368

21-369

21-370

27-700

27-702

27-703

Bone Files

REF	Description	Type	Length
40-1370	Bone File	double end no. 10 pattern, plain serrations	7" (17.8 cm)
40-1371	Bone File	double end no. 33 pattern, plain serrations	7" (17.8 cm)
40-1375	Bone File (MILLER)	double end no. 64 pattern, plain serrations	7" (17.8 cm)
40-1380	Bone File (MILLER)	double end no. 45 pattern, plain serrations	7" (17.8 cm)
40-1381	Bone File (HOWARD)	double end no. 12 pattern, plain serrations	7" (17.8 cm)
40-1382	Bone File (HOWARD)	double end no. 12A pattern, one end plain, other end cross serrated	7" (17.8 cm)
40-1385	Bone File (HOWARD)	double end no. 12CA BELL pattern, cross serrations	7" (17.8 cm)
40-2800	POLOKOFF Bone File	double end, narrow pattern (POL-1)	7-1/4" (18.4 cm)



40-1370

40-1371

40-1375

40-1380

40-1381

40-1382

40-1385

40-2800

MILTEX® DILATORS

- Probes & Directors 166
- Lacrimal Probes 167
- Probes & Dilators..... 168
- Catheters 169
- Sounds 170
- Scoops 171



Probes & Directors

REF	Description	Type	Length
10-2-NS	MILTEX Probe	double ended, malleable, nickel-silver	4-1/2" (11.4 cm)
10-2-ST	MILTEX Probe	double ended, malleable, sterling	4-1/2" (11.4 cm)
10-4-NS	MILTEX Probe	double ended, malleable, nickel-silver	5" (12.7 cm)
10-4-ST	MILTEX Probe	double ended, malleable, sterling	5" (12.7 cm)
10-6-NS	MILTEX Probe	double ended, malleable, nickel-silver	5-1/2" (14 cm)
10-6-ST	MILTEX Probe	double ended, malleable, sterling	5-1/2" (14 cm)
10-8-NS	MILTEX Probe	double ended, malleable, nickel-silver	6" (15.2 cm)
10-8-ST	MILTEX Probe	double ended, malleable, sterling	6" (15.2 cm)
10-10-NS	MILTEX Probe	double ended, malleable, nickel-silver	7" (17.8 cm)
10-10-ST	MILTEX Probe	double ended, malleable, sterling	7" (17.8 cm)
10-12-NS	MILTEX Probe	double ended, malleable, nickel-silver	8" (20.3 cm)
10-12-ST	MILTEX Probe	double ended, malleable, sterling	8" (20.3 cm)
10-14-NS	MILTEX Probe	double ended, malleable, nickel-silver	10" (25.4 cm)
10-14-ST	MILTEX Probe	double ended, malleable, sterling	10" (25.4 cm)
<hr/>			
10-22-SS	MILTEX Probe	with eye, malleable, stainless	4-1/2" (11.4 cm)
10-22-ST	MILTEX Probe	with eye, malleable, sterling	4-1/2" (11.4 cm)
10-24-SS	MILTEX Probe	with eye, malleable, stainless	5" (12.7 cm)
10-24-ST	MILTEX Probe	with eye, malleable, sterling	5" (12.7 cm)
10-26-SS	MILTEX Probe	with eye, malleable, stainless	5-1/2" (14 cm)
10-26-ST	MILTEX Probe	with eye, malleable, sterling	5-1/2" (14 cm)
10-28-SS	MILTEX Probe	with eye, malleable, stainless	6" (15.2 cm)
10-28-ST	MILTEX Probe	with eye, malleable, sterling	6" (15.2 cm)
10-30-SS	MILTEX Probe	with eye, malleable, stainless	7" (17.8 cm)
10-30-ST	MILTEX Probe	with eye, malleable, sterling	7" (17.8 cm)
10-32-SS	MILTEX Probe	with eye, malleable, stainless	8" (20.3 cm)
10-32-ST	MILTEX Probe	with eye, malleable, sterling	8" (20.3 cm)
10-34-SS	MILTEX Probe	with eye, malleable, stainless	10" (25.4 cm)
10-34-ST	MILTEX Probe	with eye, malleable, sterling	10" (25.4 cm)
<hr/>			
10-38	MILTEX Probe	with Myrtle Leaf	5" (12.7 cm)
<hr/>			
10-79	MILTEX Grooved Director	with Probe tip & Tongue tie	4-1/2" 11.4 cm)
10-80	MILTEX Grooved Director	with Probe tip & Tongue tie	5" (12. cm)
10-82	MILTEX Grooved Director	with Probe tip & Tongue tie	5-1/2" 14 cm)
10-84	MILTEX Grooved Director	with Probe tip & Tongue tie	6" (15. cm)
<hr/>			
28-100	LARRY Probe & Grooved Director	-	7" (17.8 cm)

Please refer to the reference section on page 536 for French conversions.



10-2 to
10-14

10-22 to
10-34

10-38



10-79 to
10-84

28-100

Probes

REF	Description	Type	Size	Length
18-710	French Pattern Lacrimal Probe	bayonet shape	00 (0.7 mm)	5" (12.7 cm)
18-712	French Pattern Lacrimal Probe	bayonet shape	0 (0.9 mm)	5" (12.7 cm)
18-714	French Pattern Lacrimal Probe	bayonet shape	1 (1.2 mm)	5" (12.7 cm)
18-716	French Pattern Lacrimal Probe	bayonet shape	2 (1.3 mm)	5" (12.7 cm)
18-718	French Pattern Lacrimal Probe	bayonet shape	3 (1.4 mm)	5" (12.7 cm)
18-720	French Pattern Lacrimal Probe	bayonet shape	4 (1.5 mm)	5" (12.7 cm)
18-740	BOWMAN Lacrimal Probe	sterling	0000-000 (0.4 mm)	5" (12.7 cm)
18-742	BOWMAN Lacrimal Probe	sterling	00-0 (0.7 mm)	5" (12.7 cm)
18-744	BOWMAN Lacrimal Probe	sterling	1-2 (0.9 mm)	5" (12.7 cm)
18-746	BOWMAN Lacrimal Probe	sterling	3-4 (1.3 mm)	5" (12.7 cm)
18-748	BOWMAN Lacrimal Probe	sterling	5-6 (1.5 mm)	5" (12.7 cm)
18-750	BOWMAN Lacrimal Probe	sterling	7-8 (1.8 mm)	5" (12.7 cm)
19-210	BUCK (SPENCER) Ear Probe	sterling shaft	-	5-1/2" (14 cm)
20-100	THEOBALD (FISH) Sinus Probe	sterling	-	6" (15.2 cm)
20-102	SKILLERN Sinus Probe	graduated, sterling	-	6-1/2" (16.5 cm)
28-106	BUIE Fistula Probe	with 5-1/2" (14 cm) sterling shaft	-	6-3/4" (17.1 cm)
28-108	PRATT Rectal Probe	with 7-3/4" (19.7 cm) sterling shaft	-	10" (25.4 cm)
28-109	BARR double ended Probe	rigid	-	7" (17.8 cm)



18-710 to
18-720

18-740 to
18-750

19-210

20-100

20-102

28-106

28-108

28-109

Probes & Dilators

REF	Description	Size	Length
14-4-15	MAYO Common Duct Probe, malleable shaft	15 French (5 mm)	10" (25.4 cm)
14-4-18	MAYO Common Duct Probe, malleable shaft	18 French (6 mm)	10" (25.4 cm)
14-8	BAKES Common Duct Dilator Set	fitted plastic case containing 9 Dilators, malleable shafts	3 mm to 11 mm
14-10-3	BAKES Common Duct Dilator	3 mm diameter	8-3/4" (22.2 cm)
14-10-4	BAKES Common Duct Dilator	4 mm diameter	8-3/4" (22.2 cm)
14-10-5	BAKES Common Duct Dilator	5 mm diameter	8-3/4" (22.2 cm)
14-10-6	BAKES Common Duct Dilator	6 mm diameter	8-3/4" (22.2 cm)
14-10-7	BAKES Common Duct Dilator	7 mm diameter	8-3/4" (22.2 cm)
14-10-8	BAKES Common Duct Dilator	8 mm diameter	8-3/4" (22.2 cm)
14-10-9	BAKES Common Duct Dilator	9 mm diameter	8-3/4" (22.2 cm)
14-10-10	BAKES Common Duct Dilator	10 mm diameter	8-3/4" (22.2 cm)
14-10-11	BAKES Common Duct Dilator	11 mm diameter	8-3/4" (22.2 cm)
14-12	MIXTER Irrigating Dilating Probe	malleable, with Luer Lock, silver plated	12" (30.5 cm)

Please refer to the reference section on page 536 for French conversions.



14-4-15



14-4-18

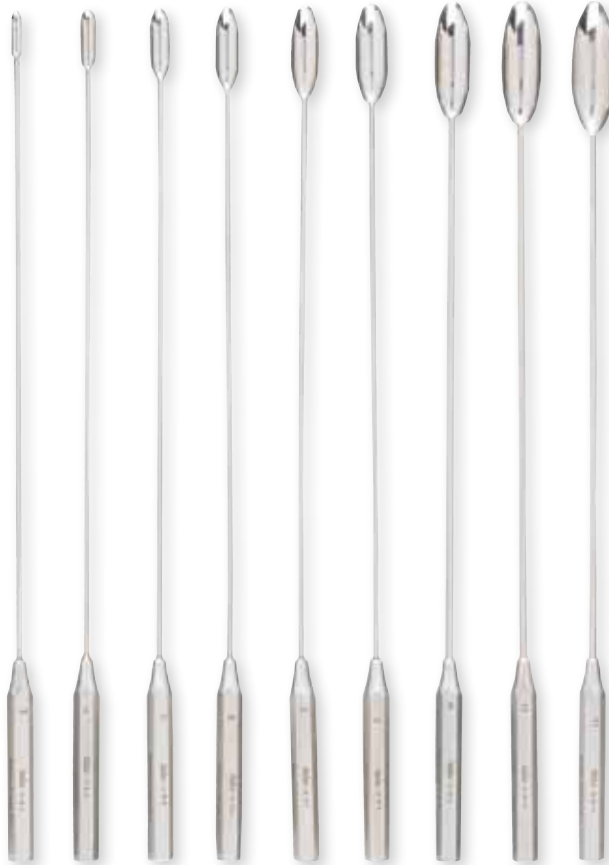

14-8 (set)
14-10-3 to 14-10-11



14-12

Catheters

REF	Description	Size	Length
29-32-8	Female Catheter	8 French (2.6 mm)	5-3/4" (14.6 cm)
29-32-10	Female Catheter	10 French (3.3 mm)	5-3/4" (14.6 cm)
29-32-12	Female Catheter	12 French (4 mm)	5-3/4" (14.6 cm)
29-32-14	Female Catheter	14 French (4.6 mm)	5-3/4" (14.6 cm)
29-32-16	Female Catheter	16 French (5.3 mm)	5-3/4" (14.6 cm)
29-32-18	Female Catheter	18 French (6 mm)	5-3/4" (14.6 cm)
29-33-12	WALTHER Female Dilator-Catheter	12 French (4 mm)	5-1/4" (13.3 cm)
29-33-14	WALTHER Female Dilator-Catheter	14 French (4.6 mm)	5-1/4" (13.3 cm)
29-33-16	WALTHER Female Dilator-Catheter	16 French (5.3 mm)	5-1/4" (13.3 cm)
29-33-18	WALTHER Female Dilator-Catheter	18 French (6 mm)	5-1/4" (13.3 cm)
29-33-20	WALTHER Female Dilator-Catheter	20 French (6.6 mm)	5-1/4" (13.3 cm)
29-33-22	WALTHER Female Dilator-Catheter	22 French (7.3 mm)	5-1/4" (13.3 cm)
29-33-24	WALTHER Female Dilator-Catheter	24 French (8 mm)	5-1/4" (13.3 cm)
29-33-26	WALTHER Female Dilator-Catheter	26 French (8.6 mm)	5-1/4" (13.3 cm)
29-33-28	WALTHER Female Dilator-Catheter	28 French (9.2 mm)	5-1/4" (13.3 cm)
29-33-30	WALTHER Female Dilator-Catheter	30 French (10 mm)	5-1/4" (13.3 cm)
29-33-32	WALTHER Female Dilator-Catheter	32 French (10.6mm)	5-1/4" (13.3 cm)
29-33-34	WALTHER Female Dilator-Catheter	34 French (11.2mm)	5-1/4" (13.3 cm)
29-33-36	WALTHER Female Dilator-Catheter	36 French (11.9mm)	5-1/4" (13.3 cm)
29-33-38	WALTHER Female Dilator-Catheter	38 French (12.5mm)	5-1/4" (13.3 cm)
29-48	VAN BUREN Catheter Guide	8 French (2.6 mm)	17" (43.2 cm)

Please refer to the reference section on page 536 for French conversions.



29-32-8 to
29-32-18



29-33-12 to
29-33-38



29-48

Sounds

REF	Description	Size	Length
29-2	VAN BUREN Urethral Sound, set of 6 sounds	even sizes 14 French (4.6 mm) to 24 French (8 mm)	11" (27.9 cm)
29-4	VAN BUREN Urethral Sound, set of 12 sounds	even sizes 8 French (2.6 mm) to 30 French (10 mm)	11" (27.9 cm)
29-6-8	VAN BUREN Urethral Sound	8 French (2.6 mm)	11" (27.9 cm)
29-6-10	VAN BUREN Urethral Sound	10 French (3.3 mm)	11" (27.9 cm)
29-6-12	VAN BUREN Urethral Sound	12 French (4 mm)	11" (27.9 cm)
29-6-14	VAN BUREN Urethral Sound	14 French (4.6 mm)	11" (27.9 cm)
29-6-16	VAN BUREN Urethral Sound	16 French (5.3 mm)	11" (27.9 cm)
29-6-18	VAN BUREN Urethral Sound	18 French (6 mm)	11" (27.9 cm)
29-6-20	VAN BUREN Urethral Sound	20 French (6.6 mm)	11" (27.9 cm)
29-6-22	VAN BUREN Urethral Sound	22 French (7.3 mm)	11" (27.9 cm)
29-6-24	VAN BUREN Urethral Sound	24 French (8 mm)	11" (27.9 cm)
29-6-26	VAN BUREN Urethral Sound	26 French (8.6 mm)	11" (27.9 cm)
29-6-28	VAN BUREN Urethral Sound	28 French (9.2 mm)	11" (27.9 cm)
29-6-30	VAN BUREN Urethral Sound	30 French (10 mm)	11" (27.9 cm)
29-6-32	VAN BUREN Urethral Sound	32 French (10.6 mm)	11" (27.9 cm)
29-6-34	VAN BUREN Urethral Sound	34 French (11.2 mm)	11" (27.9 cm)
29-6-36	VAN BUREN Urethral Sound	36 French (11.9 mm)	11" (27.9 cm)
29-6-38	VAN BUREN Urethral Sound	38 French (12.5 mm)	11" (27.9 cm)
29-6-40	VAN BUREN Urethral Sound	40 French (13.2 mm)	11" (27.9 cm)
29-14-8	McCREA Extra Small Urethral Sound	8 French (2.6 mm)	7" (17.8 cm)
29-14-10	McCREA Extra Small Urethral Sound	10 French (3.3 mm)	7" (17.8 cm)
29-14-12	McCREA Extra Small Urethral Sound	12 French (4 mm)	7" (17.8 cm)
29-14-14	McCREA Extra Small Urethral Sound	14 French (4.6 mm)	7" (17.8 cm)
29-14-16	McCREA Extra Small Urethral Sound	16 French (5.3 mm)	7" (17.8 cm)
29-14-18	McCREA Extra Small Urethral Sound	18 French (6 mm)	7" (17.8 cm)
29-14-20	McCREA Extra Small Urethral Sound	20 French (6.6 mm)	7" (17.8 cm)
29-14-22	McCREA Extra Small Urethral Sound	22 French (7.3 mm)	7" (17.8 cm)
29-14-24	McCREA Extra Small Urethral Sound	24 French (8 mm)	7" (17.8 cm)
29-14-26	McCREA Extra Small Urethral Sound	26 French (8.6 mm)	7" (17.8 cm)
29-14-28	McCREA Extra Small Urethral Sound	28 French (9.2 mm)	7" (17.8 cm)
29-14-30	McCREA Extra Small Urethral Sound	30 French (10 mm)	7" (17.8 cm)
29-14-32	McCREA Extra Small Urethral Sound	32 French (10.6 mm)	7" (17.8 cm)
29-14-34	McCREA Extra Small Urethral Sound	34 French (11.2 mm)	7" (17.8 cm)
29-14-36	McCREA Extra Small Urethral Sound	36 French (11.9 mm)	7" (17.8 cm)

Please refer to the reference section on page 536 for French conversions.



29-2 to
29-4
29-6-8 to
29-6-40

29-14-8 to
29-14-36

Scoops

REF	Description	Type	Size	Length
14-22	MAYO Gall Stone Scoop	double end	-	11" (27.9 cm)
14-24-17	DESJARDIN Gall Stone Scoop	malleable shaft	17 French (5.7 mm)	11" (27.9 cm)
14-24-21	DESJARDIN Gall Stone Scoop	malleable shaft	21 French (7 mm)	11" (27.9 cm)
14-24-24	DESJARDIN Gall Stone Scoop	malleable shaft	24 French (8 mm)	11" (27.9 cm)
14-24-27	DESJARDIN Gall Stone Scoop	malleable shaft	27 French (9 mm)	11" (27.9 cm)
14-26-S	FERGUSON Gall Stone Scoop	double end, small size scoops, 3/8" (.95 cm) x 1" (2.5 cm) and 5/16" (.79 cm) x 3/4" (.9 cm)		9-1/2" (24.1 cm)
14-26-M	FERGUSON Gall Stone Scoop	double end, medium size scoops, 1/2" (1.3 cm) x 1-1/8" (2.8 cm) and 3/8" (.95 cm) x 1" (2.5 cm)		9-1/2" (24.1 cm)
14-26-L	FERGUSON Gall Stone Scoop	double end, large size scoops, 1/2" (1.3 cm) x 1-1/4" (3.2 cm) and 7/16" (1.1 cm) x 1" (2.5 cm)		9-1/2" (24.1 cm)
14-27	MAYO Common Duct Scoop	malleable shaft, small size, silver plated	-	10-1/2" (26.7 cm)
14-28	MAYO Common Duct Scoop	malleable shaft, medium size, silver plated	-	10-1/2" (26.7 cm)
14-29	MAYO Common Duct Scoop	malleable shaft, large size, silver plated	-	10-1/2" (26.7 cm)

Please refer to the reference section on page 536 for French conversions.

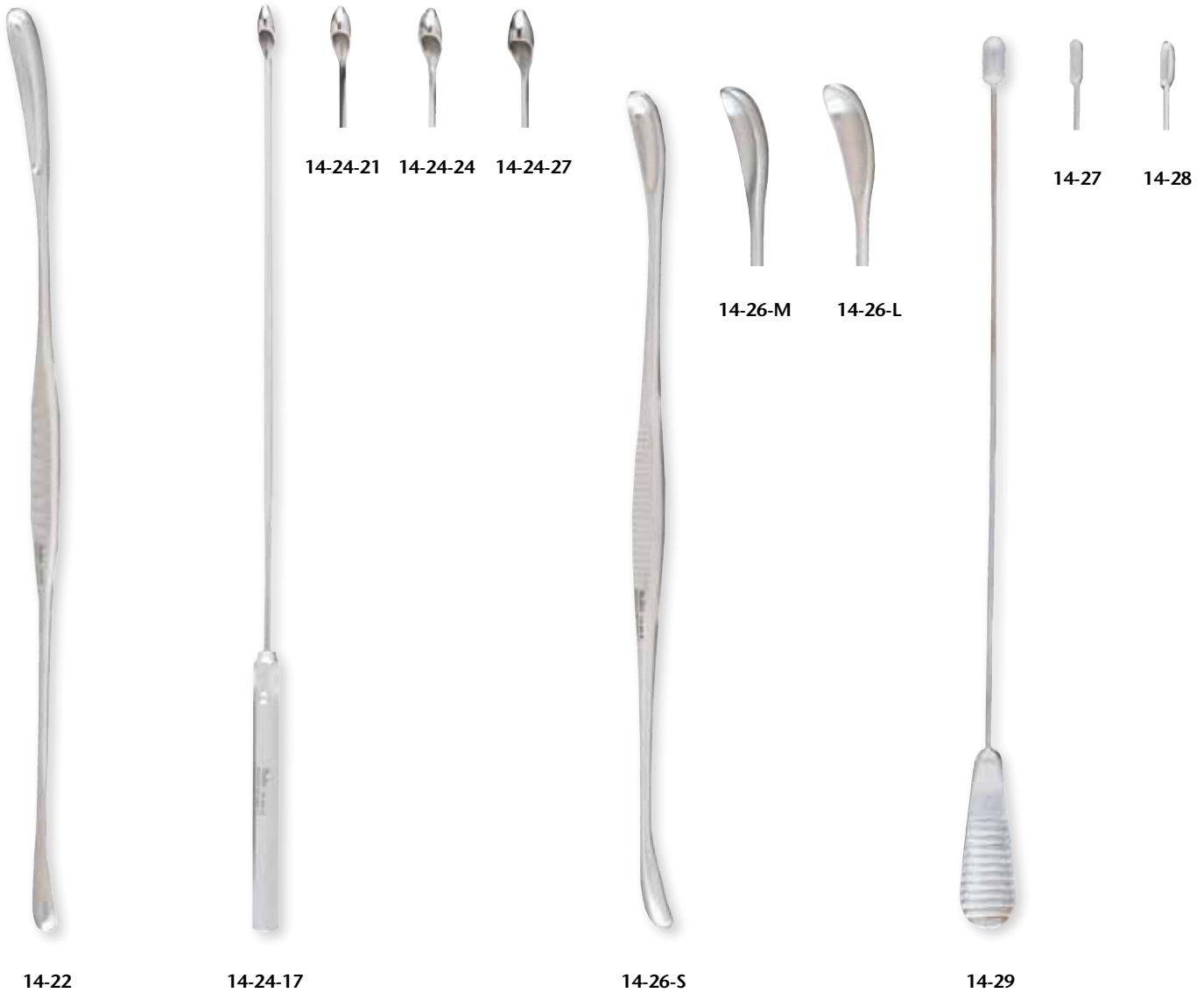

MILTEX® TROCARS

Trocars173



Trocars

REF	Description	Size	Length
13-2	NESTED Trocar, Set of 4 stainless Trocar points & cannula	6 Fr. (2 mm), 9 Fr. (3 mm), 13 Fr. (4.3 mm), 17 Fr. (5.7 mm)	-
13-8	PATTERSON Trocar, Size 1	6 mm diameter	8-1/2" (21.6 cm)
13-9	PATTERSON Trocar, Size 2	7.5 mm diameter	8-1/2" (21.6 cm)
13-10	PATTERSON Trocar, Size 3	10.5 mm diameter	8-1/2" (21.6 cm)
13-11	PATTERSON Trocar, Size 4	12 mm diameter	8-1/2" (21.6 cm)
13-20	DUKE Trocar and Cannula with perforated tube 5-1/8 (13 cm) long	17 French (5.7 mm)	4-1/2" (11.4 cm)
13-62	OCHSNER Trocar, Philadelphia pattern for use with 10 French (3.3 mm) catheter	14 French (4.7 mm)	6-1/4" (15.9 cm)
13-64	OCHSNER Trocar, Philadelphia pattern for use with 12 French (4 mm) catheter	16 French (5.3 mm)	6-1/4" (15.9 cm)
13-66	OCHSNER Trocar, Philadelphia pattern for use with 14 French (4.7 mm) catheter	18 French (6 mm)	6-1/4" (15.9 cm)
13-68	OCHSNER Trocar, Philadelphia pattern for use with 16 French (5.3 mm) catheter	20 French (6.7 mm)	6-1/4" (15.9 cm)
13-70	OCHSNER Trocar, Philadelphia pattern for use with 18 French (6 mm) catheter	22 French (7.3 mm)	6-1/4" (15.9 cm)
13-72	OCHSNER Trocar, Philadelphia pattern for use with 20 French (6.7 mm) catheter	24 French (8 mm)	6-1/4" (15.9 cm)
13-74	OCHSNER Trocar, Philadelphia pattern for use with 22 French (7.3 mm) catheter	28 French (9.3 mm)	6-1/4" (15.9 cm)

See reference section on page 536 for French conversion



MILTEX® DIAGNOSTICS

Calipers, Rulers and Gauges	175
Tonometers.....	176
Mallets & Hammers.....	177
Tuning Forks.....	178
Fiber Optic Instruments.....	179
Specula	180
Retractors, Gags and Restraints.....	181



Calipers, Rulers and Gauges

REF	Description	Type	Length
1-3015	EKG Caliper	economy line, graduated in mm, nickel plated	-
1-3200	MILTEX Fiberglass Tape Measure	1/4" (6.4 mm) wide, graduated to 60" (152.4 cm) on one side, 150 cm on other side, plastic case with push button tape return	-
18-650	CASTROVIEJO Caliper	a combination measuring and marking caliper, graduated 0-20 mm	3-1/4" (8.3 cm)
18-657	THORPE Caliper	graduated in inches and mm, permits measurements in deep areas	4-1/2" (11.4 cm)
18-658	JAMESON Caliper	graduated in inches and mm with thin tips, chrome	3-3/4" (9.5 cm)
18-660	Flexible Stainless Ruler	graduated in 1/32" (0.8 mm) fractions and mm	6" (15.2 cm) x 1/2" (1.3 cm)
27-201	MILTEX Pin & Wire Gauge	-	-



1-3015



1-3200



18-650



18-657



18-658



18-660



27-201

Tonometers

All units are constructed with jewelled hammers to minimize friction. All units are autoclavable. Scale markings are etched for accuracy and scales are inclined, permitting reading from above.

Each unit is supplied with certification that it meets the specifications established by the Committee on Standardization of Tonometers of the AAOO. Each unit is individually packaged in a fitted case with weights and a test block.

REF	Description
18-132	SCHIOTZ Tonometer, original model, with 3 weights (5.5 g, 7.5 g and 10 g) plunger, footplate and test block are stainless steel
18-132A	SCHIOTZ Tonometer, same as no. 18-132, but with ALLEN Plunger Retractor
18-139	Sterilizing Case for SCHIOTZ Tonometers, 6-1/2" (16.5 cm) x 3-1/2" (8.9 cm) x 1-1/4" (3.2 cm), fitted to firmly hold tonometer, weights and test block



18-132
18-132A



18-139

Mallets and Hammers

REF	Description	Type	Length
1-200	TAYLOR Percussion Hammer	extra small size, solid handle	7" (17.8 cm)
1-202	TAYLOR Percussion Hammer	standard size, solid handle, chrome	7-1/2" (19.1 cm)
1-208	TAYLOR Percussion Hammer	large head, loop handle, chrome	9" (22.9 cm)
1-212	Combo-5 Neuro Diagnostic Set	C-128 Tuning Fork, BUCK Hammer, pin wheel, brush and needle	-
1-213	Combo-5 Neuro Diagnostic Set	C-256 Tuning Fork, BUCK Hammer, pin wheel, brush and needle	-
1-214	Combo-4 Neuro Diagnostic Set	BUCK Hammer, pin wheel, brush and needle	-
1-220	BUCK Neurological Hammer	with brush and needle (screw into handle), chrome	7-3/4" (19.7 cm)



1-200
1-202
1-208



1-212



1-213



1-214



1-220

Tuning Forks

REF	Description	Type
19-100	MILTEX Tuning Forks	Aluminum Alloy, C-64 vibrations
19-102	MILTEX Tuning Forks	Aluminum Alloy, C-128 vibrations
19-104	MILTEX Tuning Forks	Aluminum Alloy, C-256 vibrations
19-106	MILTEX Tuning Forks	Aluminum Alloy, C-512 vibrations
19-108	MILTEX Tuning Forks	Aluminum Alloy, C-1024 vibrations
19-110	MILTEX Tuning Forks	Aluminum Alloy, C-2048 vibrations
19-112	MILTEX Tuning Forks	Aluminum Alloy, C-4096 vibrations
19-120	MILTEX Tuning Forks	Aluminum Alloy, Set of 5 Tuning Forks, C-128, C-256, C-512, C-1024 and C-2048 in fitted molded vinyl zippered case
19-120A	MILTEX Tuning Forks	fitted molded vinyl zippered case only for tuning fork set



19-100



19-102



19-104



19-106



19-108



19-110



19-112



19-120
19-120A

Loupes and LED Light System Affixes easily to your Miltex® Loupes

Loupes Magnification Chart

Magnification	Working Distance	Miltex Part Number Loupe Kit with RED FRAME	Miltex Part Number Loupe Kit with BLACK FRAME
2.5x	10"-13" (S)	1-5000	1-5011
	12"-16" (R)	1-5001	1-5012
	14"-18" (L)	1-5002	1-5013
	16"-20" (XL)	1-5003	1-5014
3.0x	10"-13" (S)	1-5004	1-5015
	13"-16" (R)	1-5005	1-5016
	16"-21" (L)	1-5006	1-5017
	18"-22" (XL)	1-5007	1-5018
3.5x	13"-16" (R)	1-5008	1-5019
	16"-20" (L)	1-5009	1-5020
	18"-22" (XL)	1-5010	1-5021

LED Mounting Chart

REF	Description	Mount Type
15050	LED Loupes Light Unit	Miltex® loupes mount
15051	LED Loupes Light Unit	Orascoptix® loupes mount
15052	LED Loupes Light Unit	Sheervision® loupes mount
15053	LED Loupes Light Unit	Surgitel® loupes mount
15054	LED Loupes Light Unit	Large Universal mount
15055	LED Loupes Light Unit	Heine® loupes mount

*NOTE: Not all mounts match all loupes.
Contact your Miltex® Representative to ensure compatibility.*

- Miltex optics quickly and easily lock into your personal setting.
- You get a custom fit without the need for individual measurement!
- LED light has an innovative power pack design with external battery cells for quick changing.
- High intensity portable dental and surgical headlight (80,000 Lux @ 14 inches).



Specula

REF	Description	Type	Blade	Length
20-2	VIENNA Nasal Speculum	large size, standard pattern	-	5-3/4" (14.6 cm)
20-3	VIENNA Speculum	medium size, standard pattern	-	5-3/4" (14.6 cm)
20-4	VIENNA Speculum	small size, standard pattern	-	5-3/4" (14.6 cm)
20-6	VIENNA Nasal Speculum	adult size, light weight	-	5-3/4" (14.6 cm)
20-7	VIENNA Nasal Speculum	child size, light weight	-	5-3/4" (14.6 cm)
20-28	KILLIAN Septum Speculum	with set screw	2" (5.1 cm)	6" (15.2 cm)
20-32	KILLIAN Septum Speculum	with set screw	3-1/2" (8.9 cm)	6" (15.2 cm)
30-10	GRAVES Vaginal Speculum	small size, original model	3/4" (1.9 cm) x 3" (7.6 cm)	-
30-50	PEDERSON Vaginal Speculum	small size, narrow blades	1/2" (1.3 cm) x 3" (7.6 cm)	-
30-62	PEDERSON Vaginal Speculum	extra narrow	5/8" (1.6 cm) x 4" (10.2 cm)	-



20-2



20-4



20-6



20-28
20-32



30-10



30-50
30-62

Retractors, Gags and Restraints

REF	Description	Length/Size
2-154	DENHARDT Mouth Gag	with grip lock
63-10	MOLT Mouth Gag	petite size, fitted with silicone tubing
63-10A	Silicone Guards	fits 63-10 petite size MOLT Mouth Gag
63-15	MOLT Mouth Gag	medium size, fitted with silicone tubing
63-15A	Silicone Guards	fits 63-15 medium size MOLT Mouth Gag
63-20	MOLT Mouth Gag	large size, fitted with silicone tubing
63-20A	Silicone Guards	fits 63-20 large size MOLT Mouth Gag
6039	Petite Mouth Gag	2-1/4" (5.7 cm) lightweight
6040	Feline Mouth Gag	3" (7.6 cm) lightweight
6041	Canine Mouth Gag	small size, 3-1/2" (8.9 cm)
6042	Canine Mouth Gag	medium size, 5-1/2" (13.9 cm)
6043	Canine Mouth Gag	large size, 7-1/2" (19.5 cm)
6600	Quick-Lock Tourniquet	complete with 32" neoprene cord
6601	Neoprene Cord (for 32" Tourniquet only)	-
V96050	Avian Oral Speculum	4-3/4" (10.8 cm), small
V96051	Avian Oral Speculum	4-3/4" (10.8 cm), medium
V96052	Avian Oral Speculum	7-1/2" (19.1 cm), large
V96053	Avian Oral Speculum	4-3/4" (10.8 cm), set of three (contains one small, medium and large speculum)



2-154



63-10 to
63-20



6039



6040



6041

6042

6043



6600
6601



V96050

V96051

V96052

MILTEX® ANESTHESIA INSTRUMENTS

Anesthesia Instruments183



Anesthesia Instruments

REF	Description	Type	Length
2-50	COLLIN Tongue Seizing Forceps	jaws 25mm wide	6-3/4" (17.1 cm)
2-60	YOUNG Tongue Seizing Forceps	with soft rubber jaws	6-1/2" (16.5 cm)
2-62	Rubber jaw replacements for YOUNG Tongue Forceps	fits REF# 2-60	-
2-70	MAGILL Endotracheal Catheter Introducing Forceps	adult size	9" (22.9 cm)
2-72	MAGILL Endotracheal Catheter Introducing Forceps	small size	7" (17.8 cm)



2-50

2-60
2-622-70
2-72

MILTEX® SUCTION & ASPIRATION INSTRUMENTS

Cannulas and Needles 185

Tracheal Tubes 186

Suction Tubes 187-189



Cannulas and Needles

REF	Description	Type	Length
23-399	Extension Cannula for Universal Handle	straight	15 cm
23-400	Extension Cannula for Universal Handle	straight	20 cm
23-402	Extension Cannula for Universal Handle	straight	30 cm
23-410	Extension Cannula for Universal Handle	curved	20 cm
23-420	Universal Handle	-	-
20-420	LICHTWICZ Antrum Trocar Needle	16 gauge, with beveled stylet & crossbar, luer lock	4-1/2" (11.4 cm)
20-428	RUSKIN Antrum Trocar Needle	straight, 16 gauge, with crossbar & tubing connection, luer lock	4" (10.2 cm)
20-430	RUSKIN Antrum Trocar Needle	curved, 16 gauge, with crossbar & tubing connection, luer lock	4" (10.2 cm)



23-399 to
23-402

23-410

23-420

20-420

20-428

20-430

Tracheal Tubes

JACKSON Trachea Tubes, improved pattern, interchangeable, rotating lock

REF	Size	O.D.	Length
23-1139SS	00	3 mm	1-5/16" (33 mm)
23-1140SS	0	5 mm	1-1/2" (38 mm)
23-1142SS	1	5.5 mm	1-3/4" (44 mm)
23-1144SS	2	6 mm	2" (51 mm)
23-1146SS	3	7 mm	2-9/32" (58 mm)
23-1148SS	4	8 mm	2-7/16" (62 mm)
23-1150SS	5	9 mm	2-5/8" (68 mm)
23-1152SS	6	10 mm	2-11/16" (69 mm)
23-1154SS	7	11 mm	2-11/16" (69 mm)
23-1156SS	8	12 mm	2-11/16" (69 mm)
23-1158SS	9	13 mm	2-11/16" (69 mm)
23-1159SS	10	14 mm	2-11/16" (69 mm)

JACKSON Trachea Tubes, regular length, interchangeable, wing lock

REF	Size	O.D.	Length
23-1199SS	00	3 mm	1-5/16" (33 mm)
23-1200SS	0	5 mm	1-1/2" (38 mm)
23-1202SS	1	5.5 mm	1-3/4" (44 mm)
23-1204SS	2	6 mm	2" (51 mm)
23-1206SS	3	7 mm	2-9/32" (58 mm)
23-1208SS	4	8 mm	2-7/16" (62 mm)
23-1210SS	5	9 mm	2-5/8" (68 mm)
23-1212SS	6	10 mm	2-11/16" (69 mm)
23-1214SS	7	11 mm	2-11/16" (69 mm)
23-1216SS	8	12 mm	2-11/16" (69 mm)
23-1218SS	9	13 mm	2-11/16" (69 mm)
23-1219SS	10	14 mm	2-11/16" (69 mm)

JACKSON Trachea Tubes, short length, short pattern, wing lock

REF	Size	O.D.	Length
23-1240SS	00	3 mm	1-5/16" (33 mm)
23-1243SS	2	6 mm	1-3/4" (44 mm)
23-1244SS	3	7 mm	1-7/8" (48 mm)
23-1245SS	4	8 mm	2-1/16" (52 mm)
23-1246SS	5	9 mm	2-3/16" (56 mm)
23-1247SS	6	10 mm	2-3/16" (56 mm)
23-1248SS	7	11 mm	2-3/16" (56 mm)
23-1249SS	8	12 mm	2-3/16" (56 mm)
23-1250SS	9	13 mm	2-3/16" (56 mm)
23-1251SS	10	14 mm	2-3/16" (56 mm)

Cleaning Brushes for Trachea and Laryngectomy Tubes, nylon bristles with stainless wire handles

			Length
23-1600	small brush	for tubes sizes 2 - 5	6" (15.2 cm)
23-1602	large brush	for tubes sizes 6 - 12	8" (20.3 cm)

O.D. Size	Actual Size	mm
00	○	3
0	○	5
1	○	5.5
2	○	6
3	○	7
4	○	8
5	○	9
6	○	10
7	○	11
8	○	12
9	○	13
10	○	14
12	○	16



23-1154SS



23-1214SS



23-1600
23-1602

Suction Tubes

REF	Description	Type	Size	Length
10-310	MILTEX POOLE Suction Tube	curved	23 French, (7.6 mm)	-
10-312	MILTEX POOLE Suction Tube	straight	30 French, (9.9 mm)	-
19-562	WILLIAM HOUSE Suction-Irrigation Tube	1.8 mm suction tube and 1.8 mm irrigating tube	5 x 5 French	9.5 cm working length
19-563	WILLIAM HOUSE Suction-Irrigation Tube	2.5 mm suction tube and 2 mm irrigating tube	6 x 8 French	9.5 cm working length
19-564	WILLIAM HOUSE Suction-Irrigation Tube	3 mm suction tube and 2 mm irrigating tube	6 x 9 French	9.5 cm working length
19-565	WILLIAM HOUSE Suction-Irrigation Tube	4.5 mm suction tube and 2 mm irrigating tube	6 x 14 French	9.5 cm working length
19-570	FRAZIER Suction Tube	angled, with finger cut-off	6 French, 2 mm	-
19-572	FRAZIER Suction Tube	angled, with finger cut-off	7 French, 2.3 mm	-
19-573	FRAZIER Suction Tube	angled, with finger cut-off	8 French, 2.6 mm	-
19-574	FRAZIER Suction Tube	angled, with finger cut-off	9 French, 3 mm	-
19-575	FRAZIER Suction Tube	angled, with finger cut-off	10 French, 3.3 mm	-
19-576	FRAZIER Suction Tube	angled, with finger cut-off	11 French, 3.6 mm	-
19-577	FRAZIER Suction Tube	angled, with finger cut-off	12 French, 4 mm	-
20-460	FRAZIER FERGUSON Suction Tube	straight, with finger cut-off	9 French (3 mm)	-
20-466	COUPLAND Suction Tube	2 interchangeable tips	-	10" (25.4 cm)



10-310



10-312



19-562 to
19-565



19-570 to
19-577



20-460



20-466

Suction Tubes

REF	Description	Type	Length
2-104SS	YANKAUER Suction Tube	removable tip and tubing connection	11-3/4" (29.8 cm)
2-106SS	Tip for YANKAUER Suction Tube	fits REF# 2-104SS	-
2-109	YANKAUER Petite Suction Tube	removable tip, delicate pattern	8-1/2" (21.6 cm)
2-110SS	ANDREWS-PYNCHON Suction Tube	delicate pattern	10" (25.4 cm)
2-111SS	Tip for ANDREWS-PYNCHON	fits REF# 2-110SS	-
10-220	ANTHONY Suction Tubes	lumen 2 mm, chrome	10" (25.4 cm)



2-104SS
2-106SS



2-109



2-110SS
2-111SS



10-220

Suction Tubes

REF	Description	Type	Size	Length
19-580	BARON Suction Tube	finger cut-off	3 French (1 mm)	working length 7.5 cm
19-582	BARON Suction Tube	finger cut-off	5 French (1.7 mm)	working length 7.5 cm
19-584	BARON Suction Tube	finger cut-off	7 French (2.3 mm)	working length 7.5 cm
19-589	ANTHONY Mastoid Suction Tube	3 mm lumen	6-1/2" (16.5 cm)	-
19-1820	Ear Suction Tube	2 interchangeable tips	20 ga. & 22 ga.	-
26-780	ADSON Suction Tube	finger valve & obturator	11 French (3.6 mm)	6" (15.2 cm)
26-782	ADSON Suction Tube	finger valve & obturator	15 French (5 mm)	8" (20.3 cm)
28-370	BUIE Suction Tube	finger valve	15 French (5 mm)	16" (40.6 cm)



19-580 to
19-584



19-589



19-1820



26-780
26-782



28-370

MILTEX® TEAT INSTRUMENTS

Teat.....191



Teat Instruments

REF	Description	Type	Length
V96032	Danish Model Teat Knife	-	-
V96033	CORNELL Teat Curette	-	-
V96034	UDALL BISTOURI Teat	-	-
V96036	CHRISTENSEN Teat Scissors	-	-
V96037	Swedish Model Curette	-	-
V96038	HUGS Teat Knife, stainless steel	blunt	6" (15.2 cm)
V96044	LICHTY Teat Knife	sharp	5-1/2" (14 cm)
V96045	LICHTY Teat Knife	blunt	5-1/2" (14 cm)
6035	CORNELL Curette	-	6-3/4" (17.1 cm)



V96038



V96044



V96045



6035

MILTEX® NAIL & HOOF INSTRUMENTS

Small Animal Toenail Nippers.....	193
Cat Claw Scissors.....	194
Foot Rot Shears.....	194



Nail Instruments

REF	Description	Type	Length
1721	Guillotine Nail Scissors	-	5" (12.7 cm)
1718-SS	WHITE Toenail Scissors	-	4-1/2" (11.4 cm)
1720	Small Animal Toenail Nipper	with latch lock	5-1/4" (13.3 cm)
40-245-SS	Tissue & Cuticle Nipper	convex jaws, stainless	4" (10.2 cm)
40-250-SS	Tissue & Cuticle Nipper	convex jaws, stainless	4-1/2" (11.4 cm)
40-251-SS	Tissue & Cuticle Nipper	convex jaws, stainless	5" (12.7 cm)
40-252	Tissue & Cuticle Nipper	convex jaws, heavy pattern, stainless	5" (12.7 cm)

*Removing scalpel blades or cutting wire using nippers and/or splitters will nick and dull the blade edges and void all warranties.



1721

1718-SS

1720

40-245-SS



40-250-SS

40-251-SS

40-252

Hoof Care & Grooming

REF	Description	Type	Length
6300	Fetlock Clipper	with wing nut, 17 X 19 teeth	6" (15.2 cm)
6301	Set of two blades	17 X 19 teeth for Fetlock Clipper	-
6302	Wing Nut	fits Fetlock Clipper	-
V91725	Hoof Knife	3/8 Blade	-
V91726	Hoof Knife	5/8 Blade	-
V91727	HUGHES Hoof Groover	-	-
V91728	HUGHES Hoof Curette	-	-
V91729	Foot Rot Shears	heavy duty spring	9" (22.9 cm)
V91730	Hoof Tester	stainless steel	13" (33 cm)
V91731	Hoof Tester Heavy Duty	-	-
V91732	Hoof Pick	-	-



MILTEX® SYRINGES

Local Anesthesia..... 196

Automatic Dosing Syringe 197



Local Anesthesia

REF	Description	Type
017-29320	LUER SYRINGE	3 ml - LOCK TIP
76-40	Petite Aspirating Syringe CW	Blue Silicone Grips
76-42	Petite Aspirating Syringe CW	Red Silicone Grips
76-43	Petite Aspirating Syringe CW	Purple Silicone Grips
76-70	Aspirating Syringe	COOK-WAITE (CW)
77-70	Petite Aspirating Syringe	COOK-WAITE (CW)



017-29320



76-40



76-42



76-43



76-70



77-70

“Regional anesthesia provided by local anesthetic agents induces complete peripheral nerve blockade for oral surgery procedures. Blood pressure, heart rate, respiration rate, cardiac output, tissue perfusion, and body temperature are maximized at low inhalant percentages. Regional nerve blocks also provide an opiate sparing effect that reduces analgesic requirements postoperatively. Preemptive analgesia may also play a role in minimizing central sensitization and “wind up” pain. Nerve blocks are performed in all oral surgical procedures in our practice to provide greater patient comfort and safety.”

Brett Beckman, DVM, DAVDC, DAAPM
*President, American Veterinary Dental Society
Fellow, Academy of Veterinary Dentistry*

Automatic Dosing Syringe

REF	Description	Type
6501	ROUX Automatic Revolver Syringe	solid brass, nickel plated, 20 cc capacity, Luer lock attachment, adjusts to 1/2 cc, 1 cc, 1-1/2 cc, 2 cc and 2-1/2 cc dosage

DIAGRAM For 6501		REF
1	Rear Handle	-
4	Connecting Piece	-
20	Dosage Setting Wheel	-
23/25	Washer Set for Glass Barrel	6501-23/25
24	Front End w/Luer Lock	-
26	Dura-Glass Barrel	6501-26
27	Metal Tube to hold Glass Barrel	-
28	Inner Rod	-
30	Silicone Piston	6501-30
31	Piston Compression Disc	6501-31
32	Piston Rod w/Ratchet Teeth	-

DIAGRAM For 6501		REF
3	Spring Holding Screws	-
5	Forward Handle	-
7	Large Locking Screw	-
11	Spring for Ratchet Tip, stainless	-
12	Cap for No. X11 Spring	-
13	Screw for Ratchet Tip	-
14	Ratchet Tip, stainless	-
16	Grub Screw	-
17	Steel Ball for Dosage Setting Wheel, stainless	-
18	Spring for Dosage Setting Wheel, stainless	-
33	Knurled Knob	-
35	Coil Spring for handles, stainless	-

* Items in bold are available for purchase

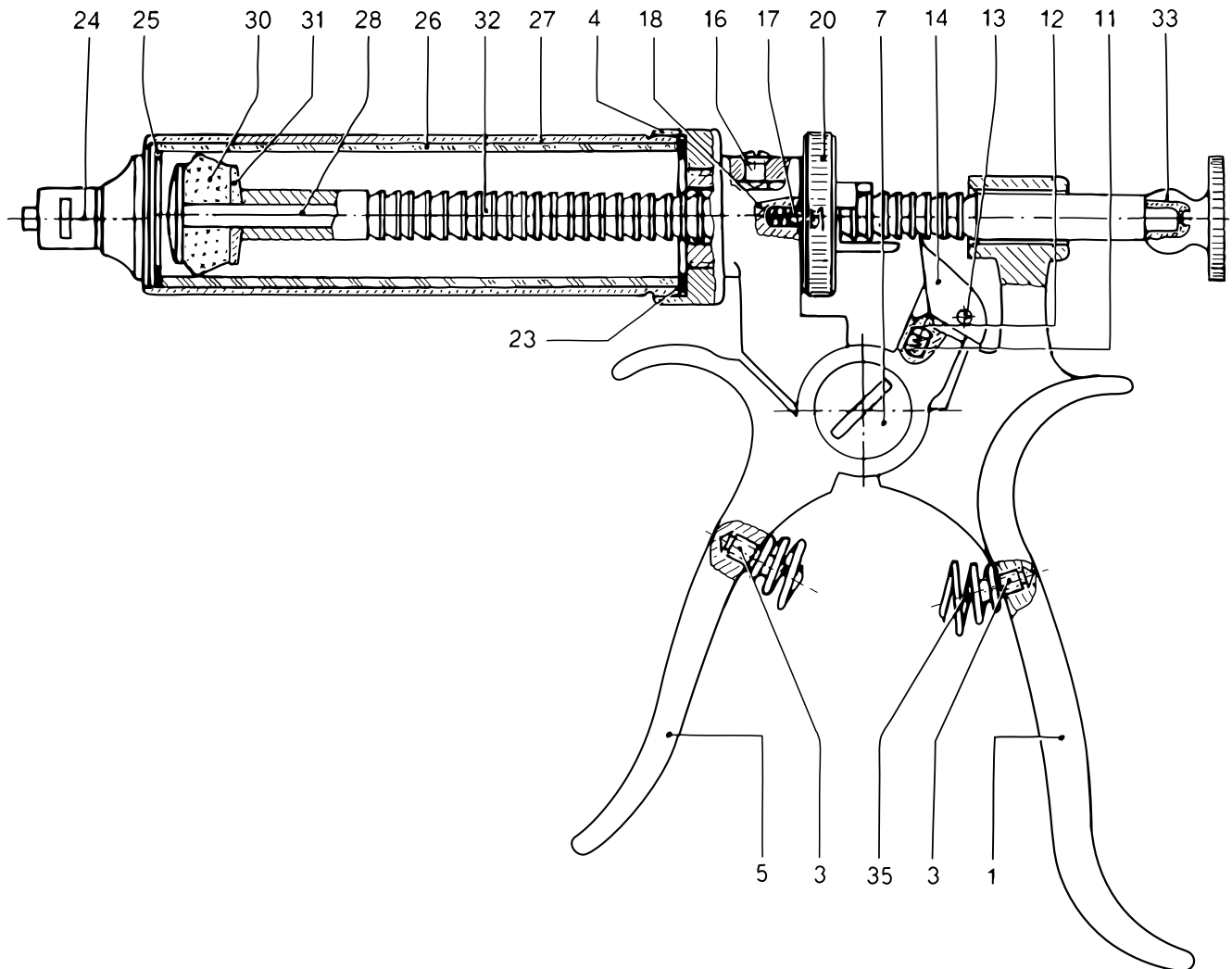













MILTEX® GENERAL DENTISTRY INSTRUMENTS

Excavators.....	199
Applicators.....	200
Burnishers	201
Carvers.....	202
Chisels	203
Composite Placement.....	204
Hatchets.....	205
Hoes	206
Wax, Porcelain & Cement Carvers.....	207
Spatulas	208
General Dentistry Syringes	209
Carbide Burs.....	210-212
Trimming & Finishing Burs.....	213
Diamond Burs	214-218
Diamond Discs & Bur Blocks.....	219
Low Speed Contra Angles.....	220
Articulating Paper	221
Lightning Strips	222
Dividers & Gauges	223
Wax.....	224-225
Dappen Dishes.....	226
Calcium Hydroxide Placer.....	227
Mouth Gags	228
Amalgam Carriers	229
Amalgam Pluggers & Condensers	230
Amalgam Wells	231
Messing Root Canal Gun	232



Excavators

Excavators are used to remove dental materials.

Description		GripLite®S ⁶	Tactile Tone™	Octagonal
1.15mm Discoid (38-39) (11.5-7-14)		80-6303	THE115	-
1.5mm Discoid (15-8-14)		80-6304	THE15	-
#17		-	-	70-4
#18		-	-	70-6
#19		-	-	70-8
#22		-	-	70-18
#3/6 Cleoid/Discoid		-	-	70-20
18 Tear-Drop		-	THE18	-
19 Tear-Drop		-	THE19	-
#31L		80-6300	THE31L	70-14
#33L		80-6302	THE33L	70-16
E2 Discoid (15-9-15)		80-6307	THEE2	-



GripLite S⁶



Tactile Tone™



Octagonal

*Tip images are enlarged to show more detail

Applicators

Applicators are used to place dental materials in cavity preparation.

Description	GripLite®S ⁶	Tactile Tone™
Applicator 1-2	-	TBAP12
Birtles Applicator Spatula	80-6601	TBBR
Birtles Applicator Spatula K	-	TBBRK

*Tip images are enlarged to show more detail













GripLite[®]S⁶



Tactile Tone™

Burnishers

Burnishers are used to smooth amalgam after condensing. These instruments can also be used with other restorative materials.

Description		GripLite®S ⁶	Tactile Tone™
1mm - 1.5mm		-	TB115
26-28		-	TB2628
26-30		-	TB2630
27-30		-	TB2730
Acorn 21		80-6203	TB21
NYU B1		-	TB NYUB1
Pitts Pedo 18		-	TB18P
Pitts Pedo 19		-	TB19P
PKT 1		80-6200	TNPKT1
PKT 3		-	TBPKT3



GripLite S⁶













Tactile Tone™

*Tip images are enlarged to show more detail

Carvers

Carvers are used to carve occlusal anatomy into amalgam (pits and fissures). These instruments can also be used with other restorative materials.

Description		GripLite®S ⁶	Tactile Tone™
Baum Interproximal		80-6401	TCIP
Cleoid Discoid 2mm		80-6405	TCCD2
Cleoid Discoid 3mm		80-6408	TCCD3
Hollenback 1/2		80-6400	TCHL12
Hollenback 3		80-6403	TCHL3
Interproximal 1		-	TCIP1
Interproximal 2		80-6407	TCIP2
PKT 4		80-6404	TCPKT4
Tanner 5		80-6406	TCTN5
University of Minnesota 1		80-6402	TCUM1



*Tip images are enlarged to show more detail

GripLite S⁶

Tactile Tone™

Chisels

Chisels are used to smooth and cut enamel in cavity preparation.

Description	Tactile Tone™
.6mm - 1mm Mon-Angle	THCM61
1.5mm Bin-Angle (15-8-8)	THCB15
1.5mm Straight (15)	UHC15
17-18 Bin-Angle	THCB1718







Tactile Tone™

*Tip images are enlarged to show more detail

Composite Placement

Composite placement instruments provide application control over white restoration materials. Sticky composite material will not adhere to the smooth surface, allowing exact contouring.

These instruments are used to carry composite material, to place and condense composite material and to carve composite material in cavity preparation.

Description		GripLite®S ⁶	Tactile Tone™	Round
2		80-6002	TD2X	-
4		-	TD4X	-
5		80-6005	TD5X	-
6		-	TD6X	-
9		-	TD9X	-
12		-	TD12X	-
F-TYPE 4		80-6004	TD4X	70-204
F-TYPE 6		80-6006	TD6X	70-206
G-TYPE 2		80-6012	TD12X	70-212
G-TYPE 3		80-6009	TD9X	70-213
G-TYPE 4		80-6034	TD8X	70-214



*Tip images are enlarged to show more detail

Hatchets

Hatchets are used to clean and smooth cavity preparation walls and unsupported enamel.

Description	Tactile Tone™
1mm (10-7-14)	THH1
1.5mm (15-8-14)	THH15
8-9 (10-7-14)	THH1B
Gold Foil 13 Off-Angled	TGF13
Gold Foil 15 Angled	TGF15



Tactile Tone™







*Tip images are enlarged to show more detail

Hoes

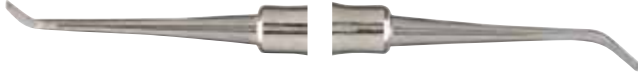
Hoes are used to loosen or dislodge heavy supramarginal calculus by using a pull stroke.

Description

Tactile Tone™

		
.8mm - 1.2mm Mon-Ang		THHO812
		
1.3mm (13-10-16)		THHO13
		
Orban 6-7 TPOR67		
		
Orban 8-9 TPOR89		
		
Rhodes 36-37		TKRH3637
		
UWH 18-19		TPH1819



Tactile Tone™

*Tip images are enlarged to show more detail

Wax, Porcelain & Cement Carvers

Wax Carvers are used to carve and cut wax during impressions and other dental applications involving dental wax. Porcelain carvers are used for carving porcelain material during inlays/onlays and crown preparations.









Description	Octagonal
Hollenback 3	73-36
Hollenback 3S	73-38
Wall 3	73-46
PKT1	73-24
PKT2	73-26
PKT3	73-28
PKT4	73-30
PKT5	73-32
Set of PK Instruments	73-34



Octagonal

*Tip images are enlarged to show more detail

Spatulas

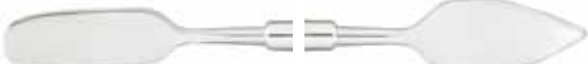
Description		GripLite®S ⁶	Tactile Tone™	Octagonal
W-31		-	-	73-58
W-7		-	-	73-62
W-7A		-	-	73-64
C-22		-	-	73-68
C-24 Flexible		80-6600	UB24	73-70
C-24A Rigid		-	-	73-72
C-5		-	-	73-76
C-7		-	-	73-78
7 Wax Double Ended		80-6602	TB7WAX	-
31 Wax Double Ended		-	TB31W	-



GripLite S⁶



Tactile Tone™



Octagonal

*Tip images are enlarged to show more detail

General Dentistry Syringes

The water syringe has a chromium-plated brass point.
The stainless float assures quick filling.

REF	Description
013-29001	Syringe, Water
013-29030	Syringe, Chip Blower
013-29060	Syringe, Hot Air
013-97200	Syringe, Presto Point Only
013-97210	Syringe, Chip Blower Syringe Point Only
017-97204	Red Rubber Bulb 211A no Valve



013-29001



013-29030



013-29060



017-97204

Luer Syringes

The metal-tipped, glass Luer Syringe is fitted with 21-gauge x 1" blunt needles.

REF	Description
017-29310	Syringe, Luer 2 ml - Lock Tip
017-29320	Syringe, Luer 3 ml - Lock Tip
017-29330	Syringe, Luer 5 ml - Lock Tip
017-29340	Syringe, Luer 10 ml - Lock Tip
017-29321	Syringe, Luer 3 ml with 3 Needles
017-29331	Syringe, Luer 5 ml with 3 Needles
017-29341	Syringe, Luer 10 ml with 3 Needles



017-29321

Tungsten Carbide Burs

KEY	Type	Length
FG	Friction Grip	19 mm long (10/pk)
RA	Right Angle Latch	22 mm long (10/pk)
HP	Hand Piece	44 mm long (5/pk)
FG-SU	Friction Grip Surgical	30 mm long (10/pk)
FG-S	Friction Grip Short Shank	15 mm long (10/pk)

Round (spherical) - Used for opening and shaping cavity preparations, caries and soft tissue removal and to open the tooth for root canal

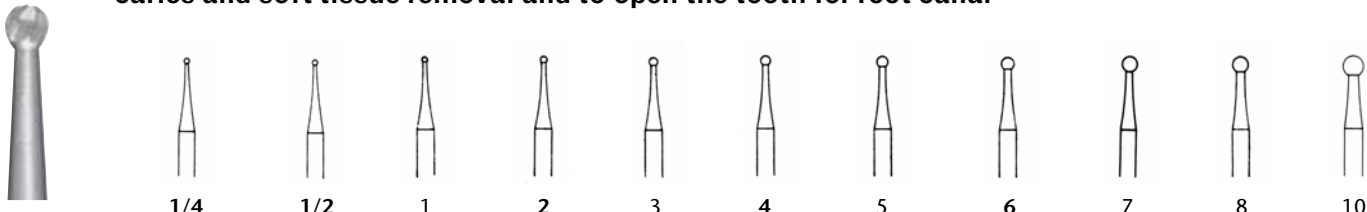

		1/4	1/2	1	2	3	4	5	6	7	8	10
FG	REF	DFG1/4	DFG1/2	DFG1	DFG2	DFG3	DFG4	DFG5	DFG6	DFG7	DFG8	-
RA	REF	-	DRA1/2	DRA1	DRA2	DRA3	DRA4	DRA5	DRA6	DRA7	DRA8	-
HP	REF	DHP1/4	DHP1/2	DHP1	DHP2	DHP3	DHP4	DHP5	DHP6	DHP7	DHP8	DHP10
FG-SU	REF	-	DFG1/2SU	-	DFG2SU	-	DFG4SU	-	DFG6SU	-	DFG8SU	-

Crosscut Fissure Taper Used for smoother cutting and to more aggressively create angled sides, flat floors, shoulders and tapered walls. Used to avoid undercuts on crown preparations

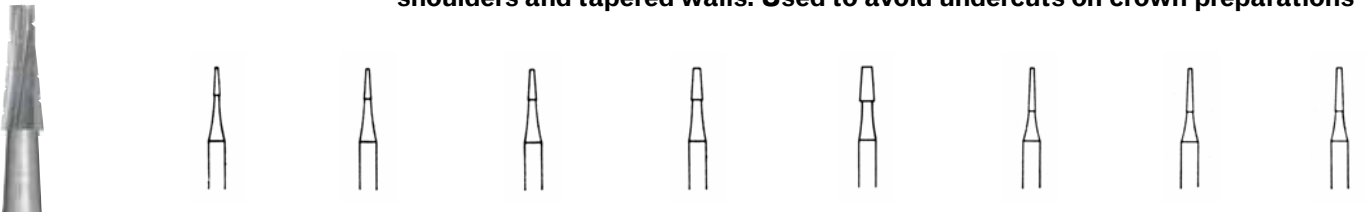

		699	700	701	702	703	699L	700L	701L
FG	REF	DFG699	DFG700	DFG701	DFG702	DFG703	DFG699L	DFG700L	DFG701L
RA	REF	DRA699	DRA700	DRA701	DRA702	DRA703	-	-	-
HP	REF	DHP699	DHP700	DHP701	DHP702	DHP703	-	-	-
FG-SU	REF	-	DFG700SU	DFG701SU	DFG702SU	DFG703SU	-	-	-

Crosscut Fissure Straight Used for smoother cutting and to more aggressively cut parallel sides and flat surfaces, flat floors, shoulders and straight walls.



		556	557	558	559	560	557L	558L
FG	REF	DFG556	DFG557	DFG558	DFG559	DFG560	DFG557L	DFG558L
RA	REF	DRA556	DRA557	DRA558	DRA559	-	-	-
HP	REF	DHP556	DHP557	DHP558	DHP559	DHP560	-	-
FG-SU	REF	-	DFG557SU	DFG558SU	DFG559SU	-	-	-

*Items in **bold** represent the most popular patterns.

Tungsten Carbide Burs

Crosscut Fissure Straight - Round Head

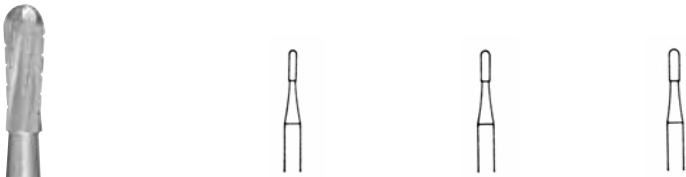

		1557	1558	1559
FG	REF	DFG1557	DFG1558	DFG1559
HP	REF	DHP1557	DHP1558	-
FG-SU	REF	-	DFG1558SU	-

Pear



		329	330	331	332
FG	REF	DFG329	DFG330	DFG331	DFG332

Fissure Straight **Used for cutting parallel sides and flat surfaces, flat floors, shoulders and straight walls**

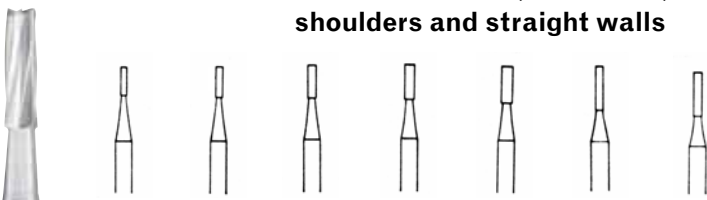

		56	57	58	59	60	57L	58L
FG	REF	DFG56	DFG57	DFG58	DFG59	DFG60	DFG57L	DFG58L

Amalgam Preparation



		245
FG	REF	DFG245

Wheel



		14
FG	REF	DFG14

End Cutting

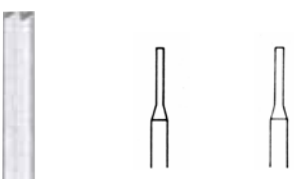

		957	958
FG	REF	DFG957	DFG958

Taper Dome



		1170	1171
FG	REF	DFG1170	DFG1171

Plain Fissure Straight - Round Head

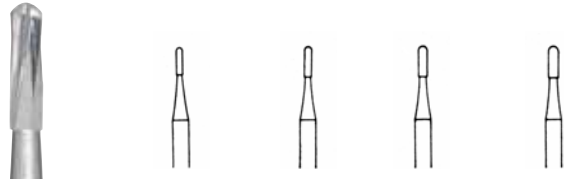

		1156	1157	1158	1159
FG	REF	DFG1156	DFG1157	DFG1158	DFG1159

Plain Fissure Taper **Used to create angled sides, flat floors, shoulders and tapered walls**

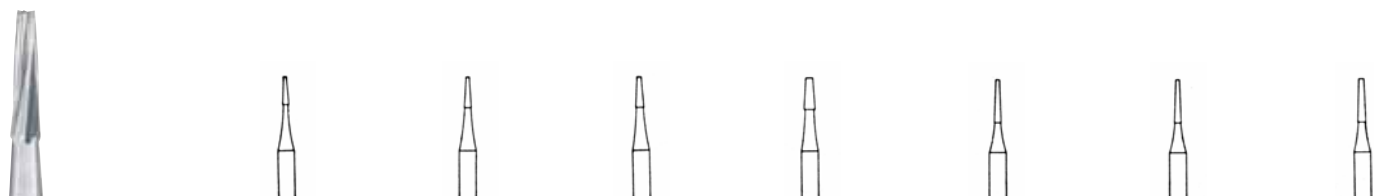

		169	170	171	172	169L	170L	171L
FG	REF	DFG169	DFG170	DFG171	DFG172	DFG169L	DFG170L	DFG171L

*Items in **bold** represent the most popular patterns.

Tungsten Carbide Burs (cont.)

Inverted Cone



		33 1/2	34	35	36	37	38	39
FG	REF	DFG331/2	DFG34	DFG35	DFG36	DFG37	DFG38	DFG39
RA	REF	DRA331/2	DRA34	DRA35	DRA36	DRA37	DRA38	DRA39
HP	REF	DHP331/2	DHP34	DHP35	DHP36	DHP37	DHP38	DHP39

Tungsten Carbide Burs (100/pk)

Friction Grip Clinic Packs



ROUND

REF	REF
DFG1/4-CL	DFG4-CL
DFG1/2-CL	DFG6-CL
DFG2-CL	DFG8-CL

INVERTED CONE

REF
DFG331/2-CL
DFG34-CL
DFG35-CL

PLAIN FISSURE STRAIGHT

REF
DFG56-CL
DFG57-CL

AMALGAM PREP

REF
DFG245-CL

PEAR

REF
DFG330-CL
DFG331-CL

CROSS CUT FISSURE STRAIGHT

REF
DFG556-CL
DFG557-CL
DFG558-CL

CROSS CUT TISSUE TAPER

REF
DFG700-CL
DFG701-CL

PLAIN TISSUE STRAIGHT ROUND HEAD

REF
DFG1157-CL

CROSS CUT FISSURE STRAIGHT ROUND HEAD

REF
DFG1557-CL
DFG1558-CL

Steel Surgical Burs

Miltex® burs are brazed lower in the neck of the instruments to strengthen the burs and to reduce breakage.

- Stainless steel
- Right Angle (RA) also known as Latch Type Only
- 28 mm bur
- 6/pk



US No.	2	4	6	8
ISO No.	010	014	018	023
REF	017-33700	017-33701	017-33702	017-33703

*Items in **bold** represent the most popular patterns.

Trimming & Finishing Burs

Trimming and Finishing burs are designed for shaping and finishing all dental materials. These instruments provide a smoother aesthetic surface.

- 1 bur per package
- Friction Grip (FG) only

Fine Crosscut Pear Shape

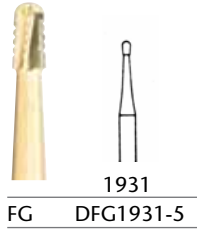

Fine Crosscut Straight Dome



T&F Round

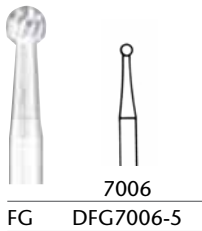

T&F

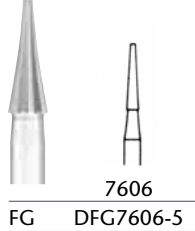

T&F Cone

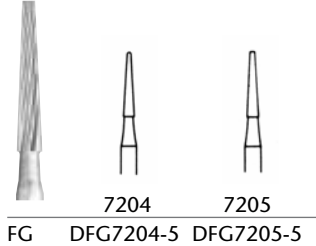

T&F Flame

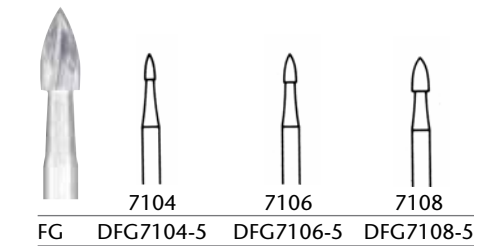

T&F Egg

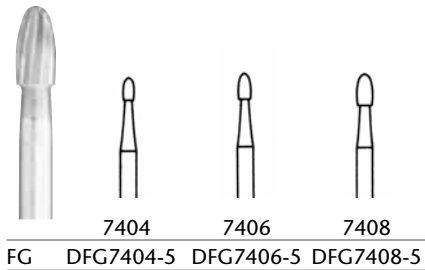

T&F Taper & Finishing

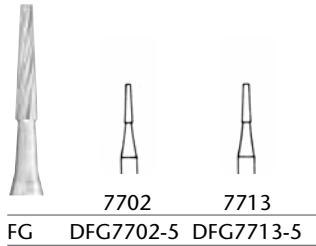

T&F Bullet

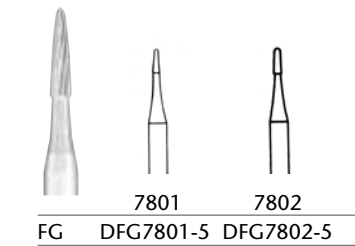

T&F Needle

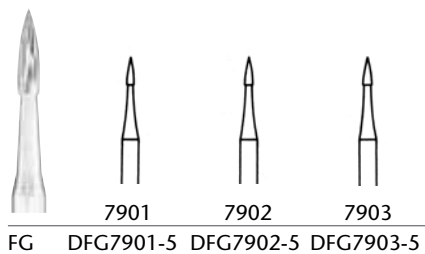

T&F Perfect Trimming

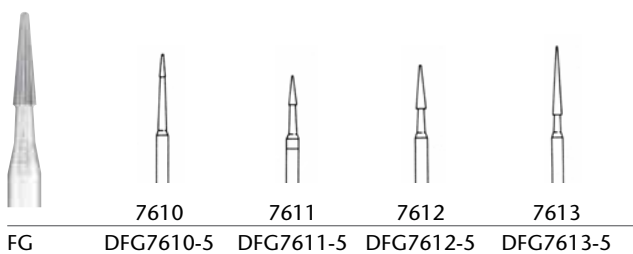

Diamond Burs

Miltex® Diamond Burs are produced using a coating technique that assures approximately 85% of the working surface is coated with a uniform diamond grit.

Color-code rings or gold plated shafts easily identify the grit. The markings conform to ISO standards.

Code	Grit	Marking
EF	Extra Fine	Gold band or gold-plated shaft
F	Fine	Red band
M	Medium	Blue band
C	Coarse	Green band

Round

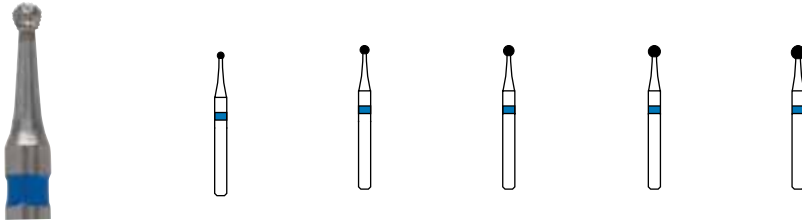

Shape	801	801	801	801	801
Diameter (1/10 mm)	9	10	14	16	18
M	801/009	801/010	801/014	801/016	801/018
C	-	-	801G014	-	-

Knife Edge

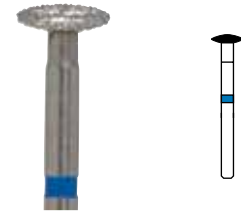

Shape	825
Diameter (1/10 mm)	42
M	825/042

Round Extended

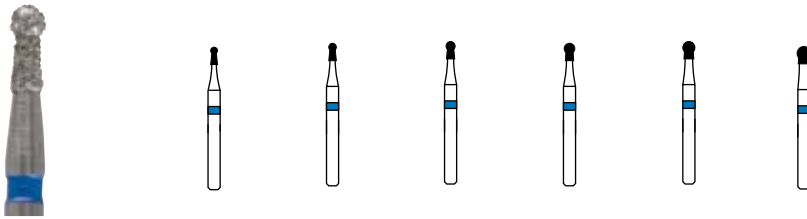

Shape	802	802	802	802	802	802
Diameter (1/10 mm)	9	10	12	14	16	18
M	802/009	802/010	802/012	802/014	802/016	802/018
C	-	-	-	802G014	-	-

End Cutting

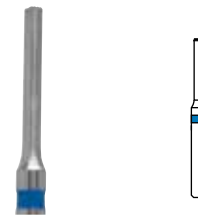

Shape	839
Diameter (1/10 mm)	10
M	839/010

Pear

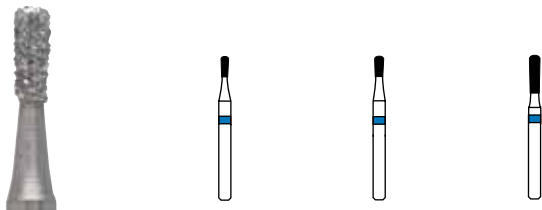

Shape	808	808	808
Diameter (1/10 mm)	10	12	14
M	808/010	808/012	808/014

Pear

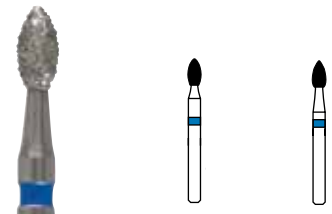

Shape	831	832
Diameter (1/10 mm)	18	18
M	831/018	832/018

*Items in **bold** represent the most popular patterns.

Diamond Burs (cont.)

Inverted Cone

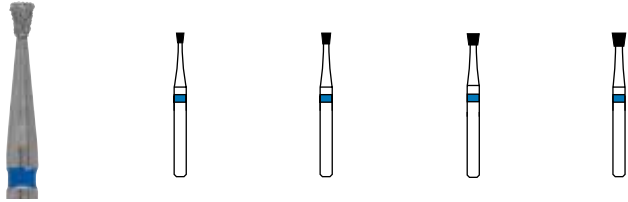

Shape	805	805	805	805
Diameter (1/10 mm)	10	12	16	18
M	805/010	805/012	805/016	805/018
C	-	805G015	-	805G018

*Items in bold represent the most popular patterns.

Long Inverted Cone



Shape	807
Diameter (1/10 mm)	16
M	807/016
C	807G016

Inverted Cone with Collar

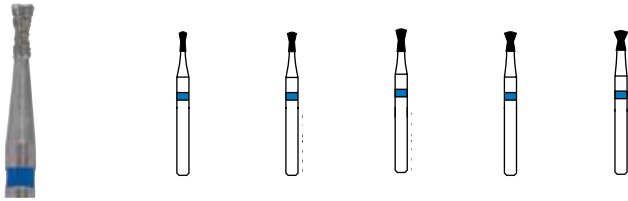

Shape	806	806	806	806	806
Diameter (1/10 mm)	10	12	14	16	18
M	806/010	806/012	806/014	806/016	806/018
C	806G012	-	806G016	-	-

Wheel with Collar



Shape	819
Diameter (1/10 mm)	14
M	819/018

Wheel

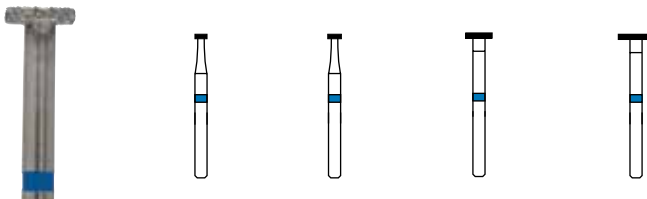

Shape	818	818	818	818
Diameter (1/10 mm)	14	18	35	47
M	818/014	818/018	818/035	818/047

Wheel Rounded



Shape	909
Diameter (1/10 mm)	35
M	909/035
C	909G035

*Items in bold represent the most popular patterns.

Diamond Burs (cont.)

Flat End Cylinder



Shape	835	835	835	835	835	836	836
Diameter (1/10 mm)	8	9	10	12	14	12	14
M	835/008	835/009	835/010	835/012	835/014	836/012	836/014
C	-	-	-	835G012	835G014	-	-

Long Flat End Cylinder



Shape	837	837	837
Diameter (1/10 mm)	14	16	18
M	837/014	837/016	837/018
C	-	-	837G018

Long Round End Cylinder



Shape	838	838	838	838
Diameter (1/10 mm)	10	12	14	16
M	838/010	838/012	838/014	838/016
C	-	-	838G014	-

Flat End Taper



Shape	845	845	845	846	846	846	847	847
Diameter (1/10 mm)	10	12	14	14	16	18	16	18
M	845/010	845/012	845/014	846/014	846/016	846/018	847/016	847/018
C	-	-	-	-	846G016	-	-	847G018

*Items in **bold** represent the most popular patterns.

Diamond Burs (cont.)

Long Flat End Taper

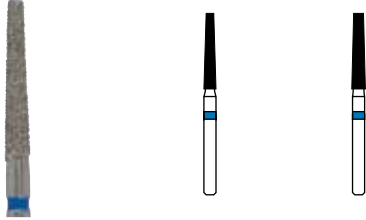

Shape	848	848
Diameter (1/10 mm)	16	18
M	848/016	848/018
C	-	848G018

Round End Taper

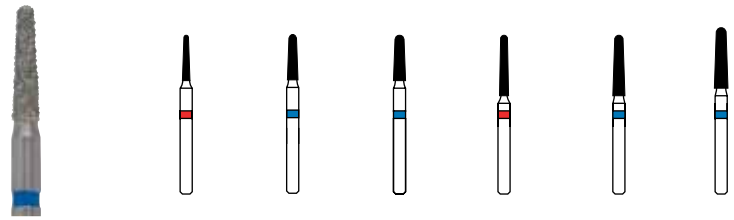

Shape	849	849	849	850	850	850
Diameter (1/10 mm)	10	14	16	12	16	18
F	849/010	-	-	850/012	-	-
M	-	849/014	849/016	-	850/016	850/018
C	-	-	849G016	-	-	850G018

Safe End Taper



Shape	851
Diameter (1/10 mm)	15
M	851/015

Christmas Tree

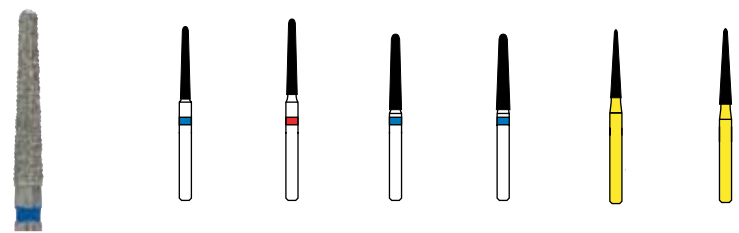

Shape	852	852	852	852	853	853
Diameter (1/10 mm)	11	14	16	18	14	16
EF	-	-	-	-	853/014	853/016
F	-	852/014	-	-	-	-
M	852/011	-	852/016	852/018	-	-
C	-	-	-	852G018	-	-

Flame

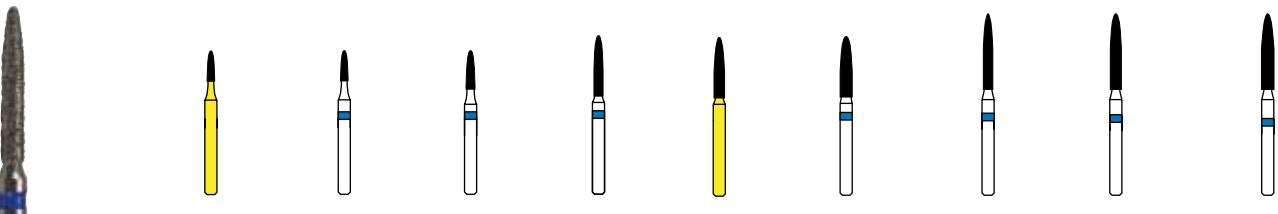

Shape	860	860	861	862	862	862	863	863	863
Diameter (1/10 mm)	9	10	12	12	14	16	12	16	18
EF	860/009	-	-	-	862/014	-	-	-	-
M	-	860/010	861/012	862/012	-	862/016	863/012	863/016	863/018
C	-	-	-	-	-	-	-	-	863G018

*Items in **bold** represent the most popular patterns.

Diamond Burs (cont.)

The shapes of Miltex® Diamond Burs have been modified to meet the latest requirements for dental techniques, including ceramic restoration and inlays.

Taper Round End

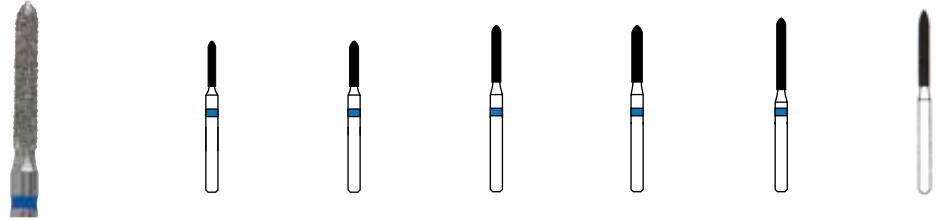

Shape	867	867	868	868	869	869
Diameter (1/10 mm)	10	12	12	14	12	14
M	867/010	867/012	868/012	868/014	869/012	869/014
C	-	-	-	868G014	-	869G014

Amalgam Remover

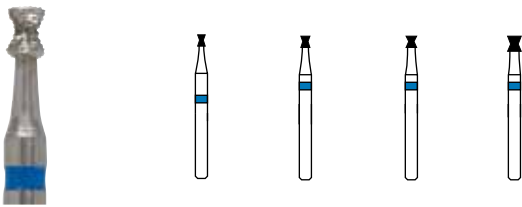

Shape	870	870	870	870
Diameter (1/10 mm)	10	12	14	18
M	870/010	870/012	870/014	870/018

Beveled Cylinder

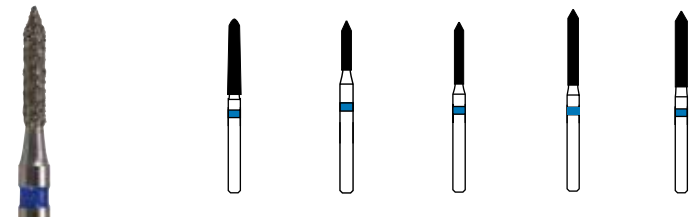

Shape	879	884	885	886	887
Diameter (1/10 mm)	18	12	12	14	16
M	879/018	884/012	885/012	886/014	887/016

Diamonds (KIT-CG)

Kit contains 9 diamond burs.

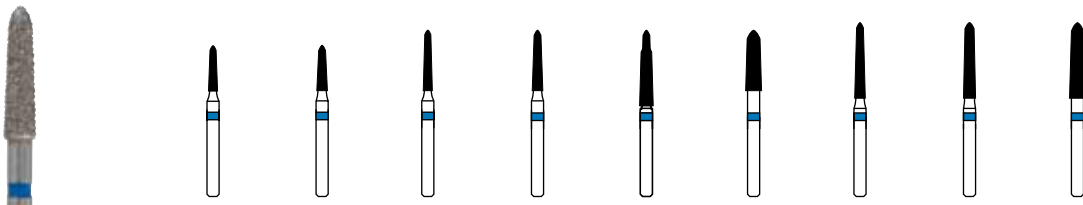

REF	GC61	GC62	GC81	GC82	GC83	GC84	GC101	GC102	GC104
-----	------	------	------	------	------	------	-------	-------	-------

PT-Diamonds (KIT-PT-DIA)

Kit contains 1 each of 6 fine and extra fine PT diamond burs in a bur block.



EF	699.514.008	159.514.010	165.514.014	166.514.014	277.514.023	195.514.009
F	699.504.008	159.504.010	165.504.014	166.504.014	277.504.023	195.504.009

Diamond Discs & Bur Blocks

REF	Description	Type	Cutting width	Diameter
914/220	MILTEX Super Flex Diamond Disc	single sided diamond coating, HP only	0.10 mm	7/8" (22 mm)
915/220	MILTEX Super Flex Diamond Disc	double sided diamond coating, HP only	0.17 mm	7/8" (22 mm)
013-33810	Magnetic Bur Holder	-	-	-
017-33820	Plastic Bur Block	Friction Grip, no cover, small	-	-
017-33825	Plastic Bur Block	Right Angle, no cover, large	-	-
017-33830	Plastic Bur Block	Friction Grip with case	-	-
017-33835	Plastic Bur Block	Right Angle with case	-	-
75-48	Magnetic Bur Block, autoclavable	White without imprint	-	-



914-220



915-220



013-33810



**017-33820 to
017-33853**



75-48

*Items in **bold** represent the most popular patterns.

Low Speed Contra Angles

REF	Description
75-12	U Contra-Angle, Friction grip, 20,000 rpm, autoclavable
75-14	MILTEX Ball Bearing Deluxe U Contra-Angle, Latch type, 40,000 rpm
75-15	Autoclavable U Contra-Angle, Latch type, 20,000 rpm
75-16	FG Contra-Angle, Push-In Type, Friction grip, 20,000 rpm, autoclavable
75-40	FG to HP Converter (Friction Type)
75-44	FG to RA Adaptor Kit
75-45	FG to RA Adaptor only
75-46	FG Bur Removing-Inserting Tool
75-38	Dental Handpiece Proply Lube Pkg of 4, 1/2 fl. oz bottles with applicators
75-38A	Handpiece Lube 1/2 fl. oz bottle
75-46	FG Bur Removing-Inserting Tool (Inserters)

Code	Description
FG	Friction Grip
RA	Right Angle Latch
HP	Hand Piece
FG-SU	Friction Grip Surgical

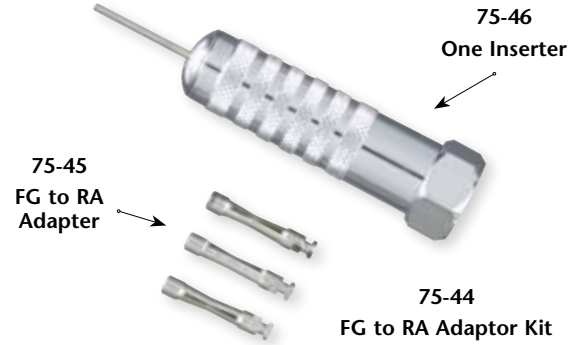

75-12



75-14



75-15



75-16



75-46



75-40
FG to HP Converter



75-38



75-38A

Articulating Paper & Forceps

Articodent™ is a super-sensitive articulating paper that clearly marks articulating surfaces and is stored in an easy-access dispenser.

Articulating Paper Forceps are stainless steel and the self-acting clamp holds strips straight to prevent errors.

REF	Description
013-38630	Mylardent with Dispenser
017-38640	Refill Roll for Mylardent
013-38801	Articodent with Dispenser, X-Thin Blue (25 Feet)
013-38802	Articodent with Dispenser, Thin Blue (25 Feet)
013-38803	Articodent with Dispenser, Thin Red (25 Feet)
013-38804	Articodent with Dispenser, Thick Blue (25 Feet)
017-38811	Articodent Refill Roll, X-Thin Blue (25 Feet)
017-38812	Articodent Refill Roll, Thin Blue (25 Feet)
017-38813	Articodent Refill Roll, Thin Red (25 Feet)
017-38814	Articodent Refill Roll, Thick Blue (25 Feet)
76-1	Posigrip Articulating Paper Forceps
76-3	VANTAGE Articulating Paper Forceps



017-38640
013-38801
013-38802
013-38803
013-38804



017-38811
017-38812
017-38814



017-38813



76-1



76-3

Lightning Strips

Lightning strips are made of resilient, high-strength materials.

- 10 strips per pack

	Type	Narrow (2.38 mm)	Medium (3.17 mm)	Wide (3.97 mm)	Assorted
Fine	Safe Sided	620-81010	620-81030	620-81050	620-81210
Medium	Safe Sided	620-81070	620-81090	620-81110	620-81230
Coarse	Safe Sided	620-81130	620-81150	620-81170	620-81250
Assorted	Safe Sided	620-81290	620-81270	620-81310	620-81190
Fine	Dual Sided	630-81330	630-81350	630-81370	630-81530
Medium	Dual Sided	630-81390	630-81410	630-81430	630-81550
Coarse	Dual Sided	630-81450	630-81470	630-81490	630-81570
Assorted	Dual Sided	630-81590	630-81610	630-81630	630-81510



620-81190



630-81510

Micro Diamonds

Micro Diamond Strips have a plastic backing and are extra durable. These strips are used to polish and finish a wide variety of dental materials.

REF	Description
404-40413	Strips, Micro Diamond Strips, Trail Pack, 6 Strips
404-40414	Strips, Micro Diamond Strips, 24 Strips



404-40414

Strip Holding Clips & Forceps

Strip Holding Forceps are designed to securely hold finishing and polishing strips during procedures, eliminating the need to hold the strip or band by hand. The 1x2 diamond-coated barrel tip gently but firmly clamps the strip, allowing precise guiding.

The forceps are sold as a pair and can be used in finishing adhesive restorations, polishing, orthodontics and prophylaxis procedures.

REF	Description
72-60	Strip Holder Clips - 90° R.A.
72-62	Strip Holder Clips - 45°
72-70	Strip Holding Forceps, Pair



72-60



72-62



72-70

Dividers & Gauges

Miltex offers Boley Gauges, Crown Gauges and Spring Bow Dividers. The Micro Boley Gauge features slender beaks which help gain easy intra-oral access to measure inside as well as outside dimensions.

REF	Description	Type
68-693	Crown Gauge	stainless steel
68-694	BOLEY Gauge	stainless steel
68-695	Spring Bow Divider	4-1/2" (11.4 cm) radius
68-696	Spring Bow Divider	6" (15.2 cm) radius
68-697	Micro BOLEY Gauge	stainless steel



68-693



68-694



68-695



68-696



68-697

Wax

All Season Wax

All Season Wax is a general purpose wax that can be used for impressions, waxing up and bite registrations.

REF	Description	Type	Size
106-55590	Wax	All Season	1 lb.
107-55710	Wax	All Season	5 lb.



All Purpose Extra-Tough Wax

All Purpose Extra-Tough Wax is a hard pink wax that is used for making occlusion rims and base plates.

REF	Description	Type	Size
110-56270	Wax	All Purpose X-Tough	1 lb.
110-56290	Wax	All Purpose X-Tough	5 lb.



Beauty Pink Wax

Beauty Pink Wax is used to make impressions and bite registrations. It is also excellent for carving. Miltex recommends that Beauty Pink Hard and Extra-Hard Wax be softened in hot water so the wax is heated throughout the sheet. Melting temperature is approximately 140° F.

REF	Description	Type	Size
116-56450	Wax	Beauty Pink, Soft	1 lb.
116-56570	Wax	Beauty Pink, Hard	1 lb.
117-56470	Wax	Beauty Pink, Soft	5 lb.
117-56590	Wax	Beauty Pink, Hard	5 lb.
116-56510	Wax	Beauty Pink, Medium	1 lb.
116-56630	Wax	Beauty Pink, X-Hard	1 lb.
117-56530	Wax	Beauty Pink, Medium	5 lb.
117-56650	Wax	Beauty Pink, X-Hard	5 lb.



Wax (cont.)

Beauty White Wax

Beauty White Wax is a soft wax and is used to make impressions and bite registrations.

REF	Description	Type	Size
120-57130	Wax	Beauty White Soft	1 lb.
120-57150	Wax	Beauty White Soft	5 lb.



Beeswax

Pure Beeswax is yellow in color and is used for bite registration and for forming wax impressions. Beeswax may also be used for application of fluoride treatments.

REF	Description	Type	Size
125-57250	Wax	Bees – pure	1 lb.
120-57150	Wax	Bees – pure	5 lb.



Boxing Wax

Boxing Wax is soft, pliable and cohesive at room temperature, yet firm enough to maintain its form during handling. Boxing Wax is used for boxing impressions in the pouring of casts.

REF	Description	Type	Size
140-57510	Wax	Boxing Green, Thick	1 lb.
140-57550	Wax	Boxing Red, Thick	1 lb.
140-57590	Wax	Boxing Green, Thin	1 lb.
140-57630	Wax	Boxing Red, Thin	1 lb.

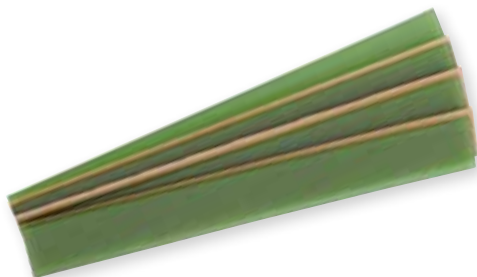

140-57510
140-57590

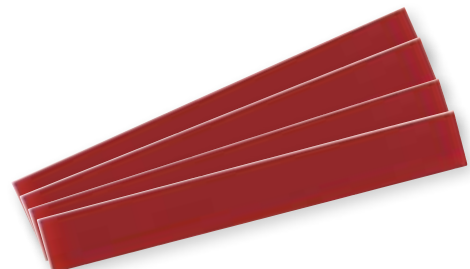

140-57550
140-57630

Dappen Dishes

Dappen Dishes are used for mixing medicaments and other materials. Available in glass dappen dishes, plastic dappen dishes with finger hold and disposable dappen dishes.

REF	Description	Type
017-48020	Dappen Dishes	Clear
017-48021	Dappen Dishes	Green
017-48022	Dappen Dishes	Amber
017-48023	Dappen Dishes	Blue
017-48011	Dappen Dishes	Plastic, Asst. Color, 200 Pack, w/finger hold
017-48002	Dappen Dishes	Disposable, 1,000 Cups, 1 oz. cups



017-48020



017-48021



017-48022



017-48023



017-48011



017-48002

Mixing Slabs

Glass Mixing Slabs have beveled edges and are used for mixing cements and paste materials. Mixing slabs are coated with a nonstick surface to help prevent material from sticking to the slab. The polyethylene coating imparts a glossy finish that facilitates mixing of materials and the pads have a non-skid polyurethane base which anchors the pad during mixing.

REF	Description	Type
017-41710	Mixing Slabs	Nonstick Coated, 6" x 3"
017-41730	Mixing Pads	1 1/2" x 2", (100 sheets per pad, 4 pads per package)
558-25871	Mixing Slabs	Clear Glass, 4" x 2-1/2" x 1/4"
558-25875	Mixing Slabs	Frosted Glass, 4" x 2" x 1/4"
558-25890	Mixing Slabs	Clear Glass, 6" x 3" x 1/2"

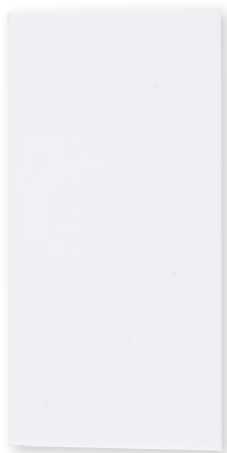

017-41710



017-41730



558-25871



558-25875



558-25890

*Items in **bold** represent the most popular patterns.

Miscellaneous Dental

Plastic Pipettes are used for slow, accurate placement of medicaments and are safe for use with most medicaments.

REF	Description
017-39960	Plastic Pipettes, Clear, Package of 5



017-39960

REF	Description
71-35	Calcium Hydroxide Placer



71-35

Retractors, Gags & Restraints

REF	Description	Length
2-154	DENHARDT Mouth Gag	with grip lock
63-10	MOLT Mouth Gag	petite size, fitted with silicone tubing
63-10A	Silicone Guards	fits 63-10 petite size MOLT Mouth Gag, 63-10
63-15	MOLT Mouth Gag	medium size, fitted with silicone tubing
63-15A	Silicone Guards	fits 63-15 medium size MOLT Mouth Gag
63-20	MOLT Mouth Gag	large size, fitted with silicone tubing
63-20A	Silicone Guards	fits 63-20 large size MOLT Mouth Gag
6039	Petite Mouth Gag	2-1/4" lightweight
6040	Feline Mouth Gag	3" lightweight
6041	Canine Mouth Gag	small size
6042	Canine Mouth Gag	medium size
6043	Canine Mouth Gag	large size
6600	Quick-Lock Tourniquet	complete with 32" neoprene cord
6601	Neoprene Cord for 32" Tourniquet	-



2-154



63-10 to
63-20



6039



6040

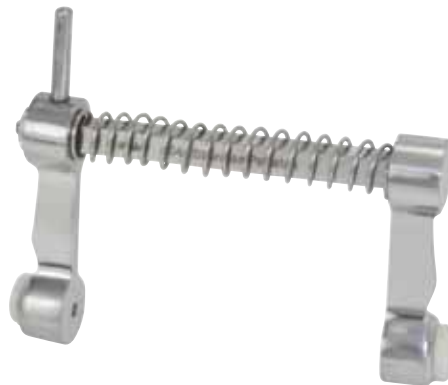

6041 to
6043



6600
6601

Amalgam Carriers

Amalgam carriers are used to carry and dispense amalgam into cavity preparations.

STAINLESS STEEL HANDLE TIP COLOR	Medium/Large White/Yellow	Medium/Jumbo White/Red	Large/Jumbo Yellow/Red	Jumbo/Jumbo Red/Red
Tungsten Carbide	71-62TC	71-64TC	71-66TC	71-68TC
Stainless Steel	71-62	71-64	71-66	71-68
Acetal	71-63	71-65	71-67	71-69



**MEDIUM/LARGE
(WHITE/YELLOW)**
71-62TC
71-62
71-63



**MEDIUM/JUMBO
(WHITE/RED)**
71-64TC
71-64
71-65











**LARGE/JUMBO
(YELLOW/RED)**
71-66TC
71-66
71-67

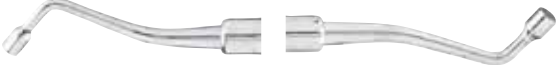

**JUMBO/JUMBO
(RED/RED)**
71-68TC
71-68
71-69

Amalgam Pluggers & Condensers

Amalgam Pluggers and Condensers are used to pack and condense amalgam and other restorative materials into cavity preparation. Can also be used with other restorative materials.

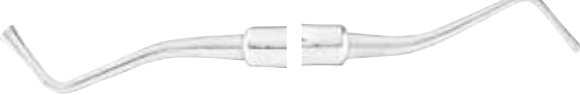
Description		GripLite®S ⁶	Tactile Tone™
.7mm - 1mm		80-6501	TF71
1.5mm - 2mm		-	TF152
2.5mm - 3mm		-	TF253
9-11		-	TF911
Blacks 0 -1 (1mm - 1.5mm)		-	TFBL01
Blacks 1- 2 (1.5mm - 2.5mm)		80-6500	TFBL12
Bodkin 1 (.7mm - 1mm)		80-6503	TFB1
Bodkin 2 (1.5mm - 2mm)		-	TFB2
Oregon 3		80-6504	TFOR3



GripLite S⁶



Tactile Tone™

*Tip images are enlarged to show more detail

K-G Retro Filling Amalgam Carriers

Designed by Drs. Henry Kahn and Harold Gerstien, this stainless steel amalgam carrier is specially designed for apical amalgam fillings. Tip diameters: small .046875"; large .078125"

REF	Description
013-24820	K-G Amalgam Carrier Small Tips .046875"
013-24821	K-G Amalgam Carrier Large Tips .078125"



013-24820



013-24821

Amalgam Wells

REF	Description
71-96	Amalgam Well - Non-Slip
AW	Amalgam Well Small (Fits Thompson Cassettes)



AW



71-96

K-G Retro Filling Amalgam Pluggers

Retro-Filling Amalgam Pluggers are designed specifically for apical amalgam fillings.

REF	Description
017-24840	Retro Filling Amalgam Plugger #1
017-24841	Retro Filling Amalgam Plugger #2



017-24840



017-24841

Messing Root Canal Gun

Designed by Dr. J.J. Messing, this Root Canal Gun is designed to function like an aspirating syringe and for apical amalgam fillings. Set includes 3 interchangeable nozzles and plunger tips (1.0, 1.30, and 1.5mm diameter) and amalgam well.

	STRAIGHT Nozzle & Plunger	CURVED Nozzle & Plunger
Complete Set	017-23500	017-23550
1 mm	017-23501	017-23551
1.30 mm	017-23502	017-23552
1.50 mm	017-23503	017-23553

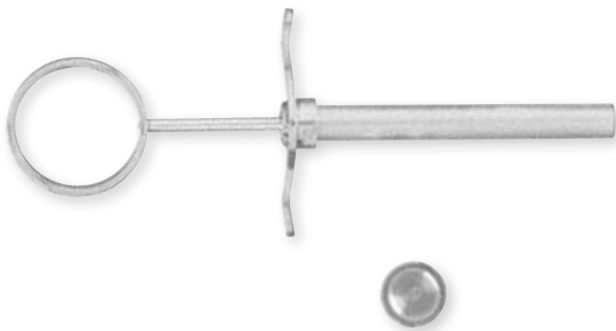

017-23500



1 mm



1.30 mm



1.50 mm

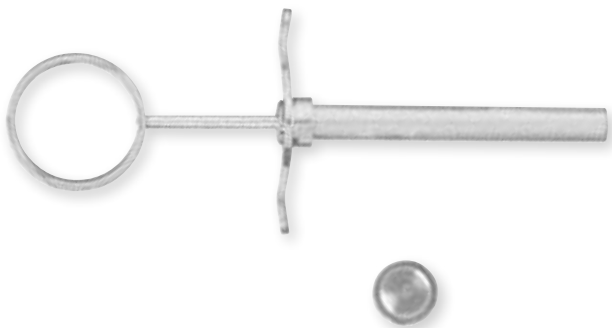

017-23550



1 mm



1.30 mm



1.50 mm

MILTEX® PROPHYLAXIS INSTRUMENTS

Miltex® WELDIN Periodontal Instrument Kit	235
Explorers - Probes	236-237
Scalers	238-239
Gracey Curettes	240-245
Gracey	240
Gracey - Rigid Shank	241
Gracey - Root Plane	242
Gracey - Root Plane Rigid Shank	243
Gracey - Root Plane Petite	244
Gracey - Root Plane Petite Rigid Shank	245
Universal Curettes	246
Files	247
Knives	248
Prophy Angles	249
Sonic Scaler	250
DenLite® Illuminated Mirror	251
Mirrors	252-255

Prophylaxis Instruments

Miltex® Prophylaxis Instruments provide the doctor and technician with the ability to offer advanced dental care. Our hygiene hand instruments have wear resistant, razor sharp points and come in a variety of handle options.

GripLite® & GripLite® S⁶

GripLite® features a lightweight size 6 resin handle

GripLite® S⁶ features a lightweight size 6 stainless steel handle

Razor-sharp points maintain edge

Ergonomically designed grips provide excellent tactile feel and reduce hand and wrist fatigue

Anti-roll feature prevents instruments from rolling when placed on trays

Color coding by instrument families

Color code rings are available for instrument personalization or procedural setups

GripLite[®]



GripLite[®] S⁶



Tactile Tone™

Silicone grips provide cushioned, stable grip

Stainless steel handle with ergonomic bumps reduces hand and wrist fatigue

Color coding by instrument families



Stainless Steel

Hollow lightweight handle reduces hand and wrist fatigue

Knurling on handles provides better grip

Variety of handle sizes (Round Size 2, Size 4, Size 6)



#2



#4



#6

Miltex® WELDIN Veterinary Periodontal Instrument Kit For Routine Treatment

The Miltex® WELDIN Periodontal Instrument Kit is a complete collection of veterinary dental instruments and accessories for oral examinations and routine periodontal prophylaxis procedures on companion animal patients.

Dedicated to the advancement of veterinary dentistry since 1981, Carol Weldin, RDH, BS, in conjunction with Miltex, Inc., has specifically selected each diagnostic and working instrument and accessory for the varying lengths and shapes of tooth structures, accessibility to anterior and posterior teeth, sulcus depths, diversity of patients and ease of instrument care and maintenance.

6809	Miltex Weldin Veterinary Perio Instrument Kit Contains:
SVET-5450	Griplite® S6 Mirror Handle, single-ended, cone-socket
67-696/3*	#3 Cone Socket Front Surface Mirror, 1 mirror
67-696/4*	#4 Cone Socket Front Surface Mirror, 1 mirror
SVET-23E/18P	Griplite S6 #23 Explorer/18 mm Probe, double-ended
SVET-5004	Griplite S6 J33/H5 (Jacquette 33/1YS Scaler)
SVET-767	Griplite S6 Morse 0-00 Scaler
SVET-5201	Griplite S6 Columbia 13/14 Universal Curette
SVET-5202	Griplite S6 Barnhart 1/2 Universal Curette
DTST**	Plastic Resin Sharpening Test Sticks, Clear, 1 stick
STN-ARK-CON	Conical Arkansas Sharpening Stone, 1 stone
STN-ARK-FLT-4	#4 Flat Arkansas Sharpening Stone, 1 stone
3-084107	Miltex Sterilization & Storage Cassette 8"L x 4-7/8"W x 1-1/8"H

*(not sold individually – 67-696/3 and 67-696/4 are 12/bx)

** (not sold individually – DTST is 6/pk)

Check with your distributor

**INCLUDES
TRAINING DVD &
INSTRUCTIONAL
CHART!**



“The Miltex® Weldin Periodontal kit is easy to use and maintain. The instruments are color coded for ease of use. Every general and specialty practice should have this wonderful kit on hand to assist them in providing proper periodontal therapy for their patients.”

Sara L. Sharp CVT VTS (Dentistry)
Secretary, Academy of
Veterinary Dental Technicians



SVET-5450
67-696/3
67-696/4



SVET-23E/18P



SVET-23E/18P



Jacquette



SVET-5004 H5



SVET-767







SVET-5201



SVET-5202

Explorers & Probes

Double ended probe point and an explorer point eliminate the need for two instruments. One end can be used for examination and the other end can be used to measure pocket depths.







Description	Markings	GripLite® S ⁶	Tactile Tone™
 <p>23E/18P</p>	1,2,3,5,6,7,8,10,11,12,13,15,16,17,18	SVET-23E/18P	-
 <p>0W-23</p>	1, 2, 3, 5, 7, 8, 9, 10	80-5401	EE0W23
 <p>4-23</p>	3, 6, 9, 12	80-5400	EE423
 <p>UNC15-23</p>	1, 2, 3, 5, 7, 8, 9, 10	-	EE1523



*Tip Images are enlarged to show more detail

Explorers - Double Ended

Explorers are used to examine teeth for caries and calculus detection, and for the exploration of furcations, restorations and pocket characteristics.









Description		GripLite® S ⁶	Tactile Tone™
2		-	EE2
5		80-5302	EE5
6		-	EE6
16		-	EE16
ODU 11/12		80-5301	EE1112
Tufts 17-23		80-5303	EE1723



*Tip Images are enlarged to show more detail

Scalers

Scalers are used to remove supragingival calculus and deposits. These instruments should never be used subgingivally.





Description	GripLite® S6	Tactile Tone™	Round
 3	-	-	70-108
 12	-	-	70-110
 15	-	UPU15	-
 1-0 Single End	-	-	70-116
 204S	80-5000	TP204S	-
 Jacquette 33/H5	SVET-5004	-	-
 Morse Scaler 0-00	SVET-767	-	-
 H6/7	80-5002	TPH67	-
 Remington 3/4	-	TPRE34	-



*Tip Images are enlarged to show more detail

Scalers

Jacquette scalers are also known as straight scalers because the cutting edges on the blade are straight.











Description		GripLite® S6	Tactile Tone™
Jacquette 2/3		80-5005	TPJ23
Jacquette 20/33		-	TPJ3033
Jacquette 2S/3S		-	TPJ2S3S
Jacquette 33-U15		80-5006	TPJ33U15
Jacquette 34/35		80-5007	TPJ3435



*Tip Images are enlarged to show more detail

Gracey Curettes

- Gracey Curettes are used for scaling, root planing and periodontal debridement
- The offset blade provides perfect working angulation to the tooth surface.











Description		GripLite® S6	Tactile Tone™	Stainless #6
Gracey 1/2		80-5101	TPG12	70-730
Gracey 3/4		80-5102	TPG34	70-732
Gracey 5/6		80-5103	TPG56	70-734
Gracey 7/8		80-5104	TPG78	70-736
Gracey 9/10		80-5105	TPG910	70-738
Gracey 11/12		80-5106	TPG1112	70-740
Gracey 13/14		80-5107	TPG1314	70-742
Gracey 15/16		80-5108	TPG1516	70-743
Gracey 17/18		80-5109	TPG1718	70-745
Gracey 11/14		-	TPG1114	70-739
Gracey 12/13		-	TPG1213	70-741

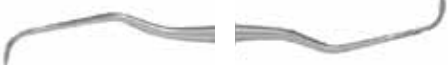

*Tip Images are enlarged to show more detail

Gracey Curettes - Rigid Shank

- Rigid Gracey Curettes have a thicker, less flexible shank, making the instruments better suited for moderate to heavy calculus removal.

Description		Tactile Tone™	Stainless #6
Gracey 1/2 Rigid Shank		TPG12R	70-730R
Gracey 3/4 Rigid Shank		TPG34R	70-732R
Gracey 5/6 Rigid Shank		TPG56R	70-734R
Gracey 7/8 Rigid Shank		TPG78R	70-736R
Gracey 9/10 Rigid Shank		TPG910R	70-738R
Gracey 11/12 Rigid Shank		TPG1112R	70-740R
Gracey 13/14 Rigid Shank		TPG1314R	70-742R
Gracey 15/16 Rigid Shank		TPG1516R	70-743R
Gracey 17/18 Rigid Shank		-	70-745R
Gracey 11/14 Rigid Shank		-	70-739R
Gracey 12/13 Rigid Shank		-	70-741R



Tactile Tone™



Stainless #6

*Tip images are enlarged to show more detail

Gracey Curettes - Root Plane

- Shank of the instrument is 3 mm longer than a standard Gracey curette. This allows for scaling, root planing and periodontal debridement of the pocket and root surface of 5 mm or more.
- The offset blade provides perfect working angulation to the tooth surface.

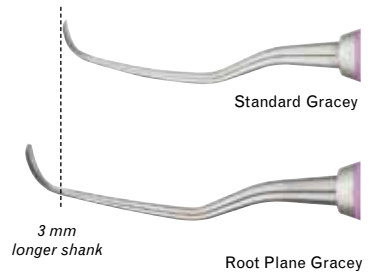

Description	GripLite® S6	Tactile Tone™
Gracey 1/2 Root Plane	80-5110	TPRP12
Gracey 3/4 Root Plane	80-5111	TPRP34
Gracey 5/6 Root Plane	80-5112	TPRP56
Gracey 7/8 Root Plane	80-5113	TPRP78
Gracey 9/10 Root Plane	-	TPRP910
Gracey 11/12 Root Plane	80-5114	TPRP1112
Gracey 13/14 Root Plane	80-5115	TPRP1314
Gracey 15/16 Root Plane	80-5116	TPRP1516
Gracey 17/18 Root Plane	-	TPRP1718
Gracey 11/14 Root Plane	-	TPRP1114
Gracey 12/13 Root Plane	-	TPRP1213



*Tip images are enlarged to show more detail

GripLite. S⁶

Tactile Tone™

Gracey Curettes - Root Plane Rigid Shank

- Shank of the instrument is 3 mm longer than a standard Gracey curette. This allows for scaling, root planing and periodontal debridement of the pocket and root surface of 5 mm or more.
- The offset blade provides perfect working angulation to the tooth surface.
- Rigid Root Plane Curettes have a thicker, less flexible shank, making the instruments better suited for moderate to heavy calculus removal.

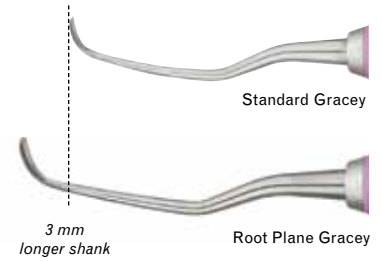

Description

Tactile Tone™

Gracey 1/2 Root Plane, Rigid Shank



TPRP12R

Gracey 3/4 Root Plane, Rigid Shank



TPRP34R

Gracey 5/6 Root Plane, Rigid Shank



TPRP56R

Gracey 7/8 Root Plane, Rigid Shank



TPRP78R

Gracey 9/10 Root Plane, Rigid Shank



TPRP910R

Gracey 11/12 Root Plane, Rigid Shank



TPRP1112R

Gracey 13/14 Root Plane, Rigid Shank



TPRP1314R

Gracey 15/16 Root Plane, Rigid Shank



TPRP1516R

Gracey 11/14 Root Plane, Rigid Shank



TPRP1114R

Gracey 12/13 Root Plane, Rigid Shank



TPRP1213R



Tactile Tone™

*Tip images are enlarged to show more detail

Gracey Cures -Root Plane Petite

- Shank of the instrument is 3 mm longer than a standard Gracey curette. This allows for scaling, root planing and periodontal debridement of the pocket and root surface of 5 mm or more.
- The petite working end, or blade, is half the length of the standard Gracey instrument which allows for better adaptation of narrow pockets and furcations.
- The offset blade provides perfect working angulation to the tooth surface.

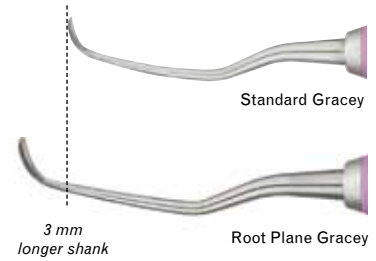

Description	GripLite® S6	Tactile Tone™
Gracey 1/2 Root Plane, Petite	80-5119	TPP12
Gracey 3/4 Root Plane, Petite	80-5120	TPP34
Gracey 5/6 Root Plane, Petite	80-5121	TPP56
Gracey 7/8 Root Plane, Petite	80-5122	TPP78
Gracey 9/10 Root Plane, Petite	80-5123	TPP910
Gracey 11/12 Root Plane, Petite	80-5124	TPP1112
Gracey 13/14 Root Plane, Petite	80-5125	TPP1314
Gracey 15/16 Root Plane, Petite	80-5126	TPP1516
Gracey 17/18 Root Plane, Petite	80-5127	TPP1718
Gracey 11/14 Root Plane, Petite	-	TPP1114
Gracey 12/13 Root Plane, Petite	-	TPP1213



GripLite S6



Tactile Tone™

*Tip images are enlarged to show more detail

Gracey Curettes - Root Plane Petite Rigid Shank

- Shank of the instrument is 3 mm longer than a standard Gracey curette. This allows for scaling, root planing and periodontal debridement of the pocket and root surface of 5 mm or more.
- The petite working end, or blade, is half the length of the standard Gracey instrument which allows for better adaptation of narrow pockets and furcations.
- Designed for specific areas of the mouth or tooth surface.
- The Rigid Root Plane Petite Curettes have a thicker, less flexible shank making the instruments better suited for moderate to heavy calculus removal.

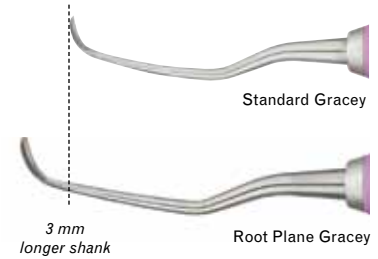

Description		Tactile Tone™
Gracey 1/2 Root Plane		TPP12R
Gracey 3/4 Root Plane		TPP34R
Gracey 5/6 Root Plane		TPP56R
Gracey 7/8 Root Plane		TPP78R
Gracey 9/10 Root Plane		TPP910R
Gracey 11/12 Root Plane		TPP1112R
Gracey 13/14 Root Plane		TPP1314R
Gracey 15/16 Root Plane		TPP1516R
Gracey 11/14 Root Plane		TPP1114R
Gracey 12/13 Root Plane		TPP1213R





Tactile Tone™

*Tip images are enlarged to show more detail

Universal Curettes

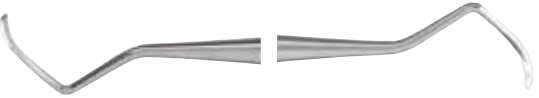
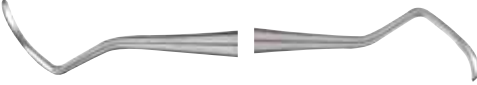
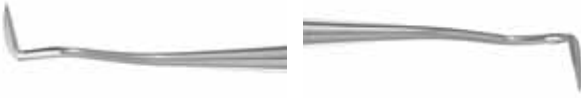
Universal curettes are used for scaling, root planing and supragingival and subgingival periodontal debridement.

Description		GripLite® S6	Tactile Tone™
Barnhart 1/2		SVET-5202	TPBA12
Barnhart 5/6		80-5203	TPBA56
Columbia 13/14		SVET-5201	TPC1314
McCalls 11/12		-	TPMC1112
McCalls 13/14		-	TPMC1314
McCalls 13S/14S		80-5204	TPMC13S14S
McCalls 17/18		-	TPMC1718
McCalls 17S/18S		80-5205	TPMC17S18S



GripLite S6



Tactile Tone™

*Tip images are enlarged to show more detail

Files

Files are used for the removal of heavy calculus by using a pull stroke.

Description	Tactile Tone™
Hirshfeld 3-7	TKHI37
Hirshfeld 5-11	TKHI511
Hirshfeld 9-10	TKHI910
Orban 10-11	TKOR1011
Orban 12-13	TKOR1213
Schluger 9-10	TKSC910
Sugerman 1-2	TKSU12
Sugerman 3-4	TKSU34











Tactile Tone™

*Tip images are enlarged to show more detail

Knives

Knives can be used for gingivectomy and gingivoplasty.

Description	Tactile Tone™	Stainless #6
 1 SE	UK1	-
 2-3	TK23	-
 Buck 5-6	TKB56	70-766
 Kirkland 13-13L	TKK1313L	-
 Kirkland 15-16	-	70-799
 Orban 1-2	TKOR12	-
 Tactile Tone™	 Stainless #6	

*Tip images are enlarged to show more detail

Prophylaxis Angles

REF	Description
75-20	Vantage PROPHY Angle, screw-on
75-22	Vantage PROPHY Angle, snap-on
75-24	MILTEX Deluxe PROPHY Angle sealed head screw-on with wrench & bottle of oil
75-26	MILTEX Deluxe PROPHY Angle sealed head snap-on with wrench & bottle of oil
75-28	VANTAGE Economy PROPHY Angle screw-on (5 angles) featuring external oil holes permitting oiling without disassembly, complete with wrench & large bottle of oil
75-30	VANTAGE Economy PROPHY Angle snap-on (5 angles) featuring external oil holes permitting oiling without disassembly, complete with wrench & large bottle of oil



75-20



75-22



75-24



75-26



75-28



75-30

Pumice

- Used for prophylaxis and polishing
- Uniform abrasive made from the finest white pumice stone

REF	Description	Packaged
568-70690	Pumice Fine	6 - 1 lb. Containers in a Carton
568-70750	Pumice Medium	6 - 1 lb. Containers in a Carton
568-70810	Pumice Coarse	6 - 1 lb. Containers in a Carton
568-70870	Pumice Flour	6 - 1 lb. Containers in a Carton
569-70830	Pumice Coarse	4 - 4 lb. Containers in a Carton
569-70850	Pumice Coarse	20 lb. Bucket
570-70710	Pumice Fine	4 - 5 lb. Containers in a Carton
570-70770	Pumice Medium	4 - 5 lb. Containers in a Carton
570-70890	Pumice Flour	4 - 5 lb. Containers in a Carton
571-70730	Pumice Fine	25 lb. Bucket
571-70790	Pumice Medium	25 lb. Bucket
571-70910	Pumice Flour	25 lb. Bucket



Mx Esonic Scaler

The Miltex® Mx ESONIC Scaler is a unique lightweight air-driven scaler which can be used to scale calculus and debris on natural dentition, implants and composites. The Mx Esonic Scaler is well-balanced and features a quick-disconnect swivel coupler. The Mx Esonic Scaler adapts to any standard 4-hole dental hose and is fully autoclavable.

Complete with three tips: Universal, Periodontal & VersaTip™

- Tips deliver water from dental lines to scaling to help flush away debris and calculus from pocket.
- Scaler is lightweight and well-balanced to reduce hand and wrist fatigue.
- Quick disconnect and swivel coupler offer easy on/off connection.
- Universal and Periodontal Tips allow thorough scaling for natural dentition.
- The VersaTip™ allows periodontal work to be completed around implants and composite restorations.

REF	Description
70-2000	Mx Esonic Scaler Universal Tip Periodontal Tip VersaTip™



Universal Tip



Periodontal Tip



VersaTip™



DENLITE® Illuminated Mirror

Bright White Light - a one-watt LED light provides shadow-free, glare-free illumination that is safe for use in any environment

Convenience - a lightweight cordless ergonomic handpiece

Versatility - split-beam technology and rugged design make the DenLite® Illuminated Mirror ideal for use as a mirror and as a retractor

Safety - disposable mirror heads and autoclavable hand piece reduce the risk of cross-contamination

Part #	Description
DP5000	DenLite LED Kit
DP5150	DenLite LED Light Cartridge
DP5200	DenLite Handle Set
DP5400	DenLite Charger Set
DP5030	DenLite Disposable Mirrors, single use (50 mirrors per box - used with DP5000)
DP5250	DenLite Handpiece Collet Assembly
DP5070	DenLite Illuminator Tip
DP1030-3	DenLite Disposable Mirror, 110V, 3 boxes of 72 mirrors (used with DP1000 AND DP1500)
DP1020	DenLite Lamp for DP1000
DP1520	DenLite Lamp for DP1500

Features

- One-watt LED Light
 - Cordless Illuminated System
 - Lightweight System
 - Disposable mirrors used with the system
 - DenLite® mirror disassembles for sterilization
 - Fully charged batteries should last 45 minutes
 - Optional autoclavable transilluminator tip
- Miltex has an extensive line of Dental Mouth Mirrors

Benefits

- Provides shadow-free and glare-free illumination
- Portable unit, can be used to provide light in any environment
- Reduces hand and wrist fatigue
- Reduces the risk of cross-contamination between patients
- Increases infection control protection for patients
- Light should last for the entire procedure before needing to be recharged
- Provides white light on both sides of the tightly focused, heat-free mirror head
- Provides equal light for detection of cracks and caries
- Meets the needs of any Clinician



DP5000



Assembled DenLite® Mirror

Mirror Handles

Available in cone socket and simple stem patterns with a variety of handle options.



Description		GripLite® S6	Tactile Tone™
Cone Socket Single End	Single Pack	80-5450	UM
Cone Socket Single End	Single Pack	SVET-5450	-
Simple Stem Single End	Single Pack	80-5152	UMS



Front Surface Mirrors

A Miltex® Front Surface Mirror eliminates the “ghost image” because the reflecting layer is no longer behind the glass but on its surface. The mirror reflects only once, providing clear vision free from all distortion.

Front Surface Mirror

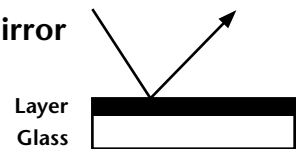

Front Surface, Cone Socket Mirrors

Description	Miltex® Mirror	Indian Head®	
		Electro-Polished	Chrome
Size 0 (Single Only)	-	011-24703	-
Size 1 (Single Only)	-	011-24702	-
Size 2	-	011-24700	-
Size 2 (Single Only)	-	011-24701	-
Size 3	67-696/3	011-24692	011-26472
Size 4	67-696/4	011-24693	011-26473
Size 5	67-696/5	011-24694	011-26474
Size 6	-	011-24695	011-26475
1-1/4" (Single Only)	-	011-24515	-
1-1/2" (Single Only)	-	011-24511	-
2"	-	011-24506	-
2" with Handle	-	011-24507	-

Sold in dozens only

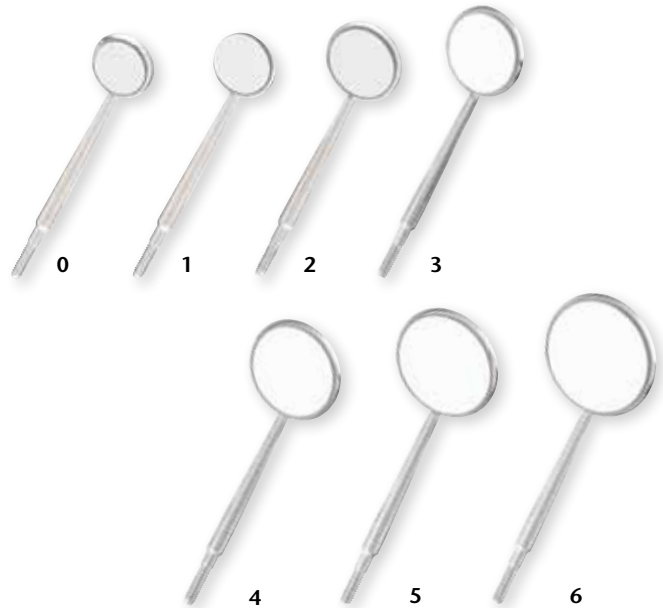

Front Surface, Simple Stem Mirrors

Description	Miltex® Mirror	Indian Head®	
		Electro-Polished	Chrome
Size 2	-	011-24674	-
Size 2 (Single Only)	-	011-24673	-
Size 3	67-698/3	011-24677	011-26422
Size 4	67-698/4	011-24678	011-26423
Size 5	67-698/5	011-24679	011-26424
Size 6	-	011-24680	011-26425
1-1/4" (Single Only)	-	011-24513	-
1-1/2" (Single Only)	-	011-24509	-
2" (Single Only)	-	011-24502	-
2" with Handle (Single Only)	-	011-24503	-

Sold in dozens only

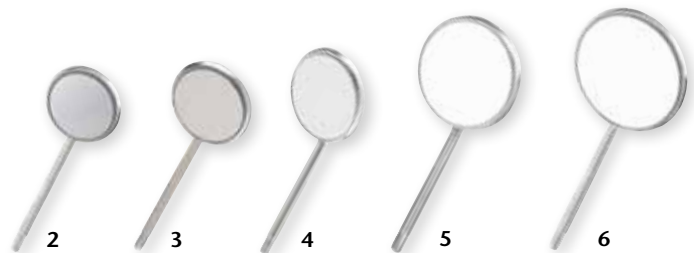

Plane Surface Mirrors

Miltex® plane surface mirrors (also known as regular mirrors) have a silver coating on the back of the glass.

As a result, light is reflected from the top of the glass as well as from the silver layer. This reflection causes a double image.

Regular Mirror

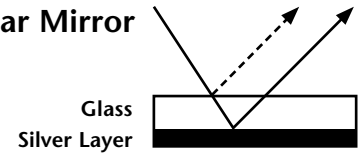

Plane Surface, Cone Socket Mirrors

Description	Miltex® Mirror	Indian Head® Electro-Polished
Size 3	67-664/3	-
Size 4	67-664/4	-
Size 5	67-664/5	-
Size 6	-	-
1-1/4" (Single Only)	-	011-24514
1-1/2" (Single Only)	-	011-24510
2" (Single Only)	-	011-24504
2" with Handle (Single Only)	-	011-24505

Sold in dozens only

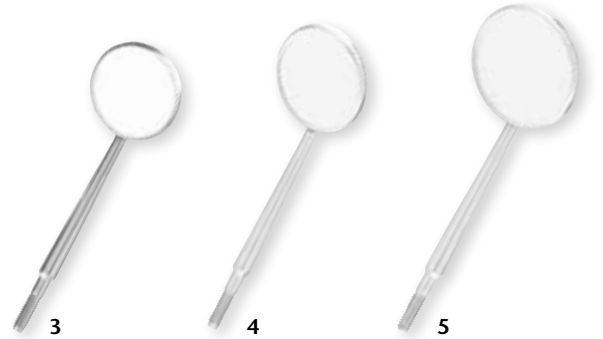

Plane Surface, Simple Stem Mirrors

Description	Miltex® Mirror	Indian Head® Electro-Polished
Size 3	67-672/3	-
Size 4	67-672/4	-
Size 5	67-672/5	-
1-1/4" (Single Only)	-	011-24512
1-1/2" (Single Only)	-	011-24508
2" (Single Only)	-	011-24500
2" with Handle (Single Only)	-	011-24501

Sold in dozens only

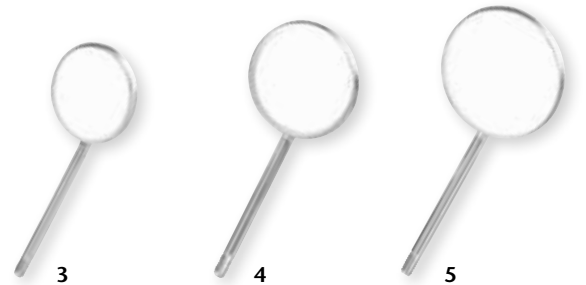

Magnifying Surface Mirrors

Miltex® magnifying mirrors are also known as concave mirrors.

Magnifying Surface, Cone Socket Mirrors

Description	Miltex® Mirror
Size 3	67-668/3
Size 4	67-668/4
Size 5	67-668/5

Sold in dozens only

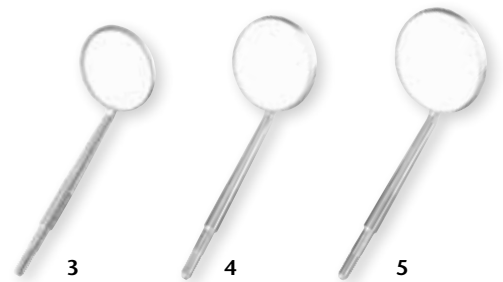

Magnifying Surface, Simple Stem Mirrors

Description	Miltex® Mirror
Size 4	67-676/4
Size 5	67-676/5

Sold in dozens only

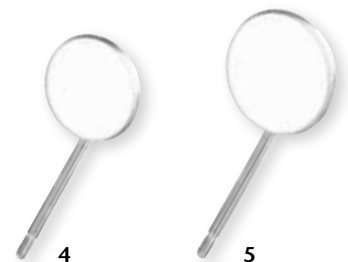

Double Sided Front Surface Mirrors

Miltex® double sided mirrors can be used to view the intra-oral cavity with both sides of the mirror.

Description	Miltex® Mirror
Size 4	67-719
Size 5	67-720

Sold in packs of 6



Micro Mirrors Cone Socket

Miltex® micro mirrors feature a rhodium front surface mirror fitted on a stainless steel mounting to assure sharpness and clarity of the reflected surface. The mirrors are used in conjunction with microscopes during periodontic and endodontic surgeries and other microsurgery procedures.

Description	Miltex® Mirror
Micro Mirror - 3mm, Oval (ea.)	017-24800
Micro Mirror - 5mm, Oval (ea.)	017-24801
Micro Mirror - 9/3mm, Rectangle (ea.)	017-24802
Micro Mirror - 7/2mm, Rectangle (ea.)	017-24803



Retro Mirrors Cone Socket

Miltex® retro mirrors feature a highly polished chrome plated brass surface. The mirrors are used for visualization of hard to reach areas or in conjunction with microscopes during micro surgeries.

Description	Miltex® Mirror
Retro Mirror #1 - 3mm, Round (ea.)	011-24804
Retro Mirror #2 - 5mm, Round (ea.)	011-24805
Retro Mirror #3 - 6mm, Round (ea.)	011-24806

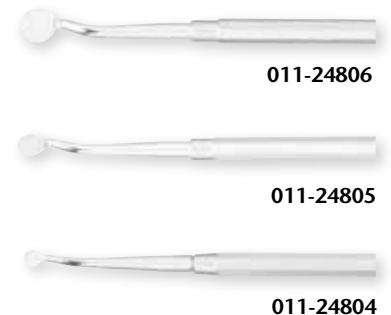

Hand Mirrors

Miltex® hand mirrors are plane surface mirrors (also known as regular mirrors).

Description	One Side Magnifying	One Side Plane
	One Side Plane	Regular Handle
3-1/2"	017-26842	011-26821
5"	017-26844	-



Intra-Oral Mirrors

Miltex® intra-oral mirrors are ideal for photography.

Description	Miltex® Mirror
No. 3 Large Occlusal Intra-Oral Mirror (2-1/2" W x 4" L)	017-26805
No. 1 Large Buccal Intra-Oral Mirror (1-3/4" W x 6" L)	017-26806
No. 2 Large Lingual Intra-Oral Mirror (1-3/4" W x 6" L)	017-26807
No. 3 Petite Occlusal Intra-Oral Mirror (2-1/2" W x 3 1/2" L)	017-26808



017-26805



017-26806



017-26807



017-26808

Reusable Front Surface Fiberglass Mirrors

Miltex® fiberglass front surface mirrors are individually wrapped to protect the mirror surface. The mirrors are autoclavable and are packed in boxes of 10.

Description	Miltex Mirror
White Size 4	67-700/4
White Size 5	67-700/5
Blue Size 4	67-710/4
Blue Size 5	67-710/5



67-700/4

67-700/5



67-710/4

67-710/5

Disposable Mirrors

Miltex® disposable plane surface mirrors are made from a durable plastic and are individually wrapped. These mirrors are ideal for home use and for use during air abrasion procedures.

Description	Miltex Mirror
Plane Surface Mirror, Size 4, Economical, 72/box	017-26810
Plane Surface Mirror, Size 4, Economical Deluxe, 72/box	017-26811



017-26810



017-26811

MILTEX® ORAL SURGERY INSTRUMENTS

Miltex® Niemiec Veterinary Extraction Instrument Kit.....	257
Local Anesthesia.....	258
Periotome Kit.....	259
Luxating Dental Elevators.....	260-261
Winged Dental Elevators	262-263
Apical Dental Elevators	264
Seldin, Cryer and Potts Dental Elevators.....	265-266
Root Tip Elevators and Picks.....	267
Periosteal Elevators.....	268
Bone Curettes	269-270
Miltex® Grip Deep Extracting Forceps.....	271-272
Extracting Forceps, Petite.....	273-276
Extracting Forceps.....	277-278
Extracting Forceps, Tungsten Carbide	279-280
Bone Files	281-282
Bone Chisels	283-284
Osteotomes	285
Sinus Lift Instruments.....	286
Rongeurs.....	287-290
Pig Tooth Nippers.....	290
Root Tip Forceps.....	291
College Pliers.....	292
Corn Suture Pliers	293
Wound Dressing Products.....	294



Miltex® Niemic Veterinary Extraction Instrument Kit

Designed and approved by Dr. Brook Niemic, D.V.M., Diplomate, American Veterinary Dental College, the MILTEX® NIEMIEC Veterinary Extraction Kit provides surgical and dental instrumentation required for companion animal dental extractions.

REF# 6806 MILTEX® Niemic Veterinary Extraction Instrument Kit Includes 1 each of:

REF	Descriptions	Feature	Size	
4-7	#3 Scalpel Handle	-	-	(1)
73-64	Baby MOLT Periosteal Elevator	-	-	(2)
DEFF	Extracting Forceps	universal, mini	-	(3)
5D-324	LA GRANGE Scissors	curved, one serrated blade, angled shank	4-1/4" (10.8 cm)	(4)
8-15TC	OLSEN-HEGAR Needle Holder	with suture scissors	5-1/2" (14 cm)	(5)
6-124	BROWN-ADSON Tissue Forceps	7x7 teeth	4-3/4" (12.1 cm)	(6)
5-16	Operating Scissors (suture scissors)	straight, sharp/blunt	5-1/2" (14 cm)	(7)
DELLUXS2	Miltex Luxating Elevator	straight	2 mm	(8)
DELLUXS3	Miltex Luxating Elevator	straight	3 mm	(9)
DELLUXS5	Miltex Luxating Elevator	straight	5 mm	(10)
DELLUXC3	Miltex Luxating Elevator	curved	3 mm	(11)
DELLUXC5	Miltex Luxating Elevator	curved	5 mm	(12)
3-085009	Miltex #9 Storage Cassette	-	8" L x 6" W x 1-3/16" H	(13)
-	Training DVD & Instructional Guide	-	-	(14)

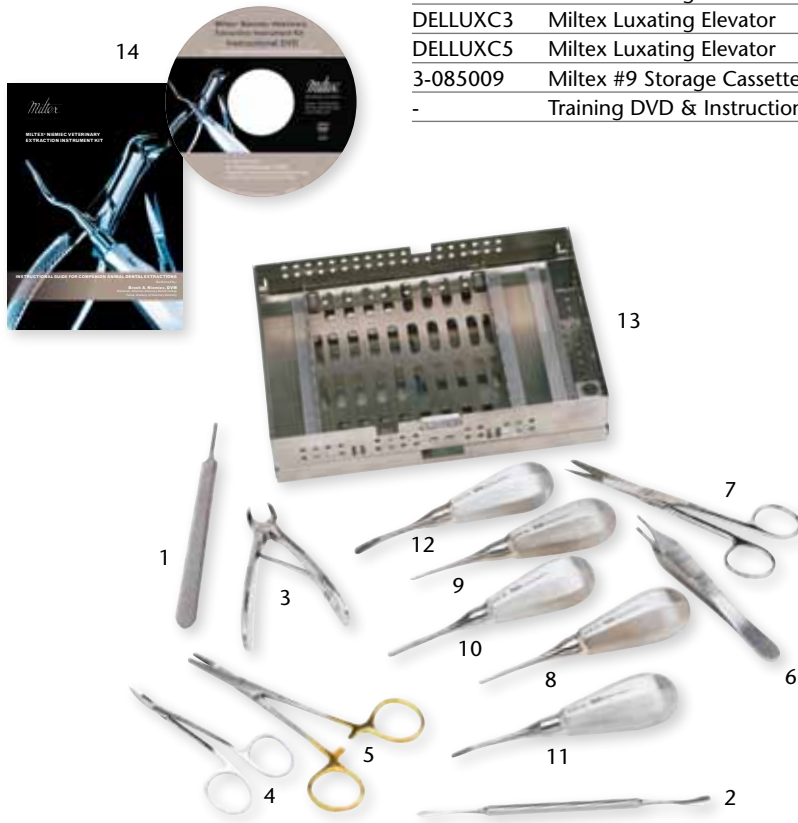

“Dental extractions are a very common veterinary procedure. As common as they are, they are not a simple undertaking and should be approached with the same in-depth preparation as any other surgical procedure. In this way, the practitioner will think through the procedure and properly prepare, avoiding common mistakes.”

“Having the proper equipment is an excellent first step. The instructional guide and training DVD is designed to help you use the instruments to their fullest extent.”

Dr. Brook Niemic, DVM
Diplomate, American Veterinary Dental College
Fellow, Academy of Veterinary Dentistry
Veterinary Dental Specialties, San Diego, CA



Creating buccal mucosal flap



Utilizing a properly sized periosteal elevator, the buccal mucosal flap is reflected



Initial elevation of the mesial buccal root

Clinical photos provided by Dr. Brook Niemic, DVM, Diplomate, American Veterinary Dental College
www.dogbeachdentistry.com

Local Anesthesia

REF	Description	Type
017-29320	LUER SYRINGE	3 ml - LOCK TIP
76-40	Petite Aspirating Syringe CW	Blue Silicone Grips
76-42	Petite Aspirating Syringe CW	Red Silicone Grips
76-43	Petite Aspirating Syringe CW	Purple Silicone Grips
76-70	Aspirating Syringe	COOK-WAITE (CW)
77-70	Petite Aspirating Syringe	COOK-WAITE (CW)



017-29320



76-40



76-42



76-43



76-70



77-70

“Regional anesthesia provided by local anesthetic agents induces complete peripheral nerve blockade for oral surgery procedures. Blood pressure, heart rate, respiration rate, cardiac output, tissue perfusion, and body temperature are maximized at low inhalant percentages. Regional nerve blocks also provide an opiate sparing effect that reduces analgesic requirements postoperatively. Preemptive analgesia may also play a role in minimizing central sensitization and “wind up” pain. Nerve blocks are performed in all oral surgical procedures in our practice to provide greater patient comfort and safety.”

Brett Beckman, DVM, DAVDC, DAAPM
*President, American Veterinary Dental Society
Fellow, Academy of Veterinary Dentistry*

Periotome Kit

Periotomes are designed for separating the periodontal ligament fibers from the tooth in preparation for a dental extraction.

Periotomes are available in three double-ended styles: straight blade, hatchet-blade and hoe-blade patterns, giving the user a wide variety of blade options. All instruments feature a lightweight size 6 stainless steel handle.

REF	Description
70-177	Periotome Kit Includes 1 each of:
70-170	Periotome Straight Double Ended
70-171	Periotome Hatchet Double Ended
70-172	Periotome Hoe Double Ended
3-072007	MILTEX® Slimline Storage Cassette 7" L x 2-5/8" W x 11/16" H



70-177 Kit



70-170



70-171



70-172

Miltex® Luxating Dental Elevator Kit

The Miltex® Luxating Dental Elevator Kit is a complete set of elevators ranging in size from 2 mm through 5 mm with curved and straight tip designs. The Luxators are designed to cut periodontal ligament while easing the tooth from the socket by rocking and cutting, rather than by lifting and prying as with a conventional elevator.

REF	Description	Length
DELLUXKIT	Miltex® Luxating Dental Elevator Kit Contains 1 each:	
DELLUXC2	Miltex Luxator- curved tip 2 mm	4-1/2" (11.4 cm)
DELLUXC3	Miltex Luxator- curved tip 3 mm	4-1/2" (11.4 cm)
DELLUXC4	Miltex Luxator- curved tip 4 mm	4-1/2" (11.4 cm)
DELLUXC5	Miltex Luxator- curved tip 5 mm	4-1/2" (11.4 cm)
DELLUXS2	Miltex Luxator- straight tip 2 mm	4-1/2" (11.4 cm)
DELLUXS3	Miltex Luxator- straight tip 3 mm	4-1/2" (11.4 cm)
DELLUXS4	Miltex Luxator- straight tip 4 mm	4-1/2" (11.4 cm)
DELLUXS5	Miltex Luxator- straight tip 5 mm	4-1/2" (11.4 cm)
3-084007	Miltex #7 Storage Cassette	8" L x 4-7/8" W x 1-1/8" H



Luxating Elevator - proper grasp/positioning



Elevator placement into the periodontal space



Miltex® Luxating Dental Elevator Kit

Clinical photos provided by Dr. Brook Niemiec, DVM, Diplomate, American Veterinary Dental College
www.dogbeachdentistry.com

Miltex® Luxating Dental Elevators

Miltex® Luxating Dental Elevators are designed with small handles to fit into the palm of the hand. Patterns include both straight and curved blades, ranging from 2 mm to 5 mm, and are made of a one-piece stainless steel construction.

REF	Description	Blade Width	Length
DELLUXC2	Miltex Luxator- curved tip	2 mm	4-1/2" (11.4 cm)
DELLUXC3	Miltex Luxator- curved tip	3 mm	4-1/2" (11.4 cm)
DELLUXC4	Miltex Luxator- curved tip	4 mm	4-1/2" (11.4 cm)
DELLUXC5	Miltex Luxator- curved tip	5 mm	4-1/2" (11.4 cm)
DELLUXS2	Miltex Luxator- straight tip	2 mm	4-1/2" (11.4 cm)
DELLUXS3	Miltex Luxator- straight tip	3 mm	4-1/2" (11.4 cm)
DELLUXS4	Miltex Luxator- straight tip	4 mm	4-1/2" (11.4 cm)
DELLUXS5	Miltex Luxator- straight tip	5 mm	4-1/2" (11.4 cm)

Curved Luxating Elevators



DELLUXC2



DELLUXC2



DELLUXC3



DELLUXC4



DELLUXC5

Straight Luxating Elevators

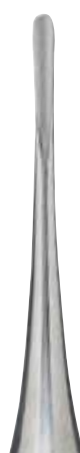

DELLUXS2



DELLUXS3



DELLUXS4

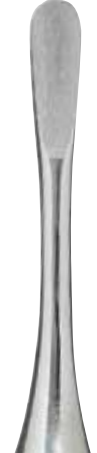

DELLUXS5

Miltex® Veterinary Winged Dental Elevator Kits

Miltex® Winged Dental Elevators, developed and approved by Dr. Robert B. Wiggs, D.V.M., Diplomate, American Veterinary Dental College, ease the extraction process and provide the Veterinarian Professional with instrumentation that meets diverse clinical needs.

Winged Dental Elevators are shaped to improve instrument adaptation to the root structure. When used in a side-to-side rocking/twisting motion, the blades provide additional leverage, especially when used between teeth in the interdental space. The winged-blades will hook under the buccal bulge, improving the angle of direction in order to lift the tooth and root.



← **Wing-Shaped Blade**
Improves instrument-tooth adaptation. Gradually tapered for easy insertion into PDL.

← **Narrow Neck**
Enhances visibility.

← **One-Piece German Stainless Steel Construction**
Reduces chance of tip separating from handle.

← **Short Handle**
Improves grip and control.

DELWNG5

REF	Description
DELWBASIC	MILTEX Winged Dental Elevator Basic Kit Contains 1 each:
DELWNG2	MILTEX Winged Dental Elevator Size 2 mm
DELWNG3	MILTEX Winged Dental Elevator Size 3 mm
DELWNG4	MILTEX Winged Dental Elevator Size 4 mm
DELWNG5	MILTEX Winged Dental Elevator Size 5 mm
3-083005	MILTEX #5 Storage Cassette 8" L x 3-13/16" W x 1-1/8" H



REF	Description
DELWDELUX	MILTEX Winged Dental Elevator Deluxe Kit Contains 1 each:
DELWNG2	MILTEX Winged Dental Elevator Size 2 mm
DELWNG3	MILTEX Winged Dental Elevator Size 3 mm
DELWNG4	MILTEX Winged Dental Elevator Size 4 mm
DELWNG5	MILTEX Winged Dental Elevator Size 5 mm
DELWNG6	MILTEX Winged Dental Elevator Size 6 mm
DELWNG7	MILTEX Winged Dental Elevator Size 7 mm
DELWNG8	MILTEX Winged Dental Elevator Size 8 mm
3-084007	MILTEX #7 Storage Cassette 8" L x 4-7/8" W x 1-1/8" H



Miltex® Veterinary Winged Dental Elevators

“I have had the opportunity to use winged elevators since I started my residency in 2001. I use nothing but winged elevators for all of my extractions. Winged elevators aid in extraction by being inserted into the periodontal ligament space and hugging the root as it is advanced precisely towards the root tip (apex) using a “side-to-side rocking/twisting motion”.

Barron P. Hall, D.V.M.

*Diplomate, American Veterinary Dental College
Fellow, Academy of Veterinary Dentistry
Animal Dental Clinic, Vienna, VA*

REF	Description	Blade Width	Length
DELWNG2	Miltex Winged Dental Elevator	Size 2 mm	4-1/2" (11.4 cm)
DELWNG3	Miltex Winged Dental Elevator	Size 3 mm	4-1/2" (11.4 cm)
DELWNG4	Miltex Winged Dental Elevator	Size 4 mm	4-1/2" (11.4 cm)
DELWNG5	Miltex Winged Dental Elevator	Size 5 mm	4-1/2" (11.4 cm)
DELWNG6	Miltex Winged Dental Elevator	Size 6 mm	4-1/2" (11.4 cm)
DELWNG7	Miltex Winged Dental Elevator	Size 7 mm	4-1/2" (11.4 cm)
DELWNG8	Miltex Winged Dental Elevator	Size 8 mm	4-1/2" (11.4 cm)



Clinical photos provided by Barron P. Hall, D.V.M. Diplomate, American Veterinary Dental College



DELWNG2



DELWNG3



DELWNG4



DELWNG6



DELWNG7



DELWNG8

Apical Dental Elevators

Miltex® Apical Elevators are made with an all-stainless steel construction and permanent welding.

REF	Description
DEL3	3 Elevator
DEL301	301 Apical Elevator
DEL302	302 Apical Elevator
DEL302HF	302HF Apical Elevator
DEL303	303 Apical Elevator
DEL303HF	303HF Apical Elevator
DEL34	34 Elevator
DEL34S	34S Elevator
DEL46	46 Elevator
DEL77R	77R Elevator, serrated
DEL81	81 Elevator
DELA	COGSWELL Elevator "A"



DEL3



DEL301

DEL302

DEL302HF

DEL303

DEL303HF



DEL34

DEL34S

DEL46

DEL77R

DEL81

DELA

Dental Elevators

REF	Description
DEL1L	1L SELDIN Elevator
DEL1R	1R SELDIN Elevator
DEL4L	4L SELDIN Elevator
DEL4R	4R SELDIN Elevator
DEL25	25 CRYER Elevator
DEL26	26 CRYER Elevator
DEL44	44 CRYER Elevator
DEL45	45 CRYER Elevator



DEL1L



DEL1L



DEL1R



DEL4L



DEL4R



DEL25



DEL26



DEL44



DEL45

Dental Elevators

REF	Description
DEL8	8 CRANE Pick Elevator
DEL6X	6X POTTS Elevator
DEL7X	7X POTTS Elevator



DEL8



DEL6X



DEL7X

Root Tip Elevators & Picks

REF	Descriptions
DEL78	78 Root Tip Elevator
DEL79	79 Root Tip Elevator
DEL80	80 Root Tip Elevator
DELH1	1 HEIDBRINK Root Tip Pick, delicate, straight
DELH2	2 HEIDBRINK Root Tip Pick, delicate, left
DELH2-3	2-3 HEIDBRINK Root Tip Pick, delicate, double ended
DELH3	3 HEIDBRINK Root Tip Pick, delicate, right



DEL78



DEL79

DEL80



DELH1



DELH2-3



DELH2



DELH3

Items in **bold** represent the most popular patterns

Periosteal Elevators

REF	Description	Type
DELM9	MOLT 9 Periosteal Elevator	-
DELOHL	OHL Periosteal Elevator	-
DELPR3	PRICHARD Periosteal Elevator	-
DELS23	23 SELDIN Periosteal Elevator	-
DELW2	2 WEST Periosteal Elevator	-
18-1968	FREER Elevator	double end sharp and blunt blades 5 mm
73-64	Baby MOLT Periosteal Elevator	-
TK24G	24G Periosteal	Tactile Tone double end
TKGF14	GF 14 Periosteal	Tactile Tone double end
TKPR3	PR3 Periosteal	Tactile Tone double end



DELM9

DELOHL

DELPR3

DELS23

DELW2

18-1968

73-64

TK24G

TKGF14

TKPR3

Items in **bold** represent the most popular patterns

Bone Curettes

REF	Description	Type
61-2	No. 75 LUCAS Curette	straight
61-4	No 85 LUCAS Curette	angular, small
61-6	No 86 LUCAS Curette	angular, medium
61-8	No 87 LUCAS Curette	angular, large
61-10	No. 1 MOLT Curette	straight, small
61-12	No. 2 MOLT Curette	straight, medium
61-14	No. 4 MOLT Curette	straight, large
61-16	No. 5L MOLT Curette	angular, small, left
61-18	No. 6R MOLT Curette	angular, small, right
61-20	No. 2/4 MOLT Curette	double end



Items in **bold** represent the most popular patterns

Bone Curettes

REF	Description	Type
TKLU85	LUCAS 85 Curette	Tactile Tone double end
TKLU86	LUCAS 86 Curette	Tactile Tone double end
TKLU87	LUCAS 87 Curette	Tactile Tone double end
TKLU88	LUCAS 88 Curette	Tactile Tone double end
TKM10	MILLER Curette 10	Tactile Tone double end
TKM11	MILLER Curette 11	Tactile Tone double end
TKMO24	MOLT 2-4 Curette	Tactile Tone double end
TPPR12	PRICHARD 1-2 Curette	Tactile Tone double end

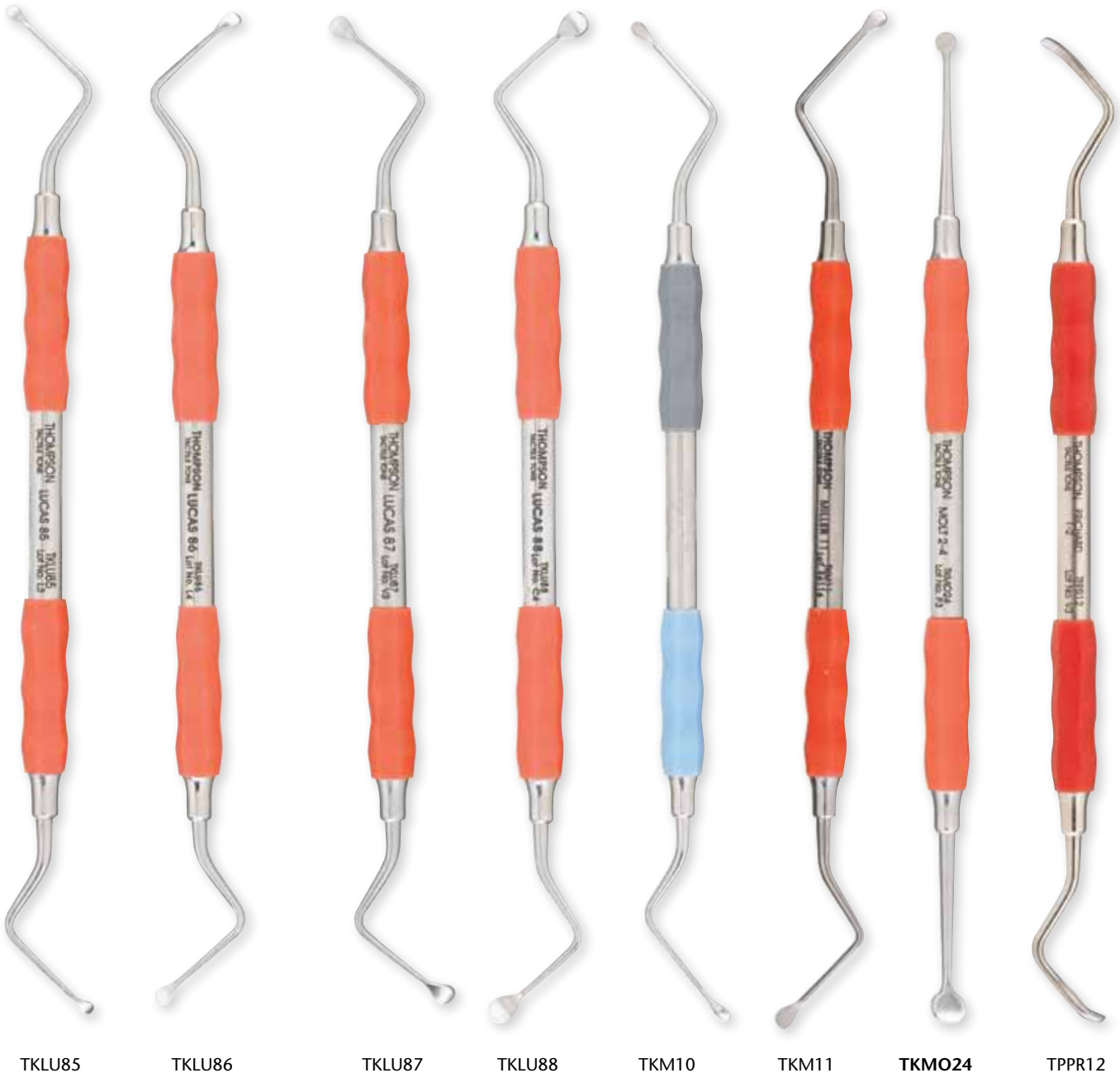

Items in **bold** represent the most popular patterns

Miltex® Grip Deep™ Extracting Forceps

Miltex® Grip Deep™ Extracting Forceps are designed to allow subgingival access to the root during extractions. Tapered beaks can provide deeper access into the tooth socket and maximize the tooth-to-forceps contact. Serrated beaks aid in gripping the tooth surface which may assist in atraumatic removal of the tooth and can potentially reduce the risk of fractures or trauma to the surrounding hard and soft tissues.

The take-apart feature of the Miltex® Grip Deep™ Extracting Forceps has a right and left side which can be separated to allow access between the box-lock / hinge area for instrument cleaning and processing. Miltex® Grip Deep™ Extracting Forceps are available in 11 patterns.

REF	Description	Length
DEFDG1STD	Extracting Forceps, 1 Standard	6-1/4"
DEFDG99C	Extracting Forceps, 99C	6-1/4"
DEFDG150	Extracting Forceps, 150	6-1/4"
DEFDG150A	Extracting Forceps, 150A	6-1/4"
DEFDG151	Extracting Forceps, 151	6-1/4"
DEFDGMD3	Extracting Forceps, MD3	6-1/4"
DEFDGMD4	Extracting Forceps, MD4	6-1/4"
DEFDG210S	Extracting Forceps, 210S	6-1/4"
DEFDG222	Extracting Forceps, 222	6-1/4"
DEFDG65	Extracting Forceps, 65	6-1/4"
DEFDG845	Extracting Forceps, 845	6-1/4"

See next page side for beak details



Take-apart feature

DEFDG1STD



"I have been using the Miltex Grip Deep Extracting Forceps for two years and been quite impressed and satisfied with their performance. The extracting forceps grip well and truly aid in my extractions. Also, they are very easy to clean and sterilize. I would recommend a set for anyone performing extractions in the dog and cat."

Dr. Barden A. Greenfield, DVM
Mid South Veterinary Dental Referrals

Items in **bold** represent the most popular patterns



*Grip Deep™ Extracting Forceps 150 shown.

Clinical photography provided by: *Barden A. Greenfield, DVM, Southwind Animal Hospital, PLC*
www.southwindvets.com



DEFDG1STD
Grip Deep 1 Standard



DEFDGMD4
Grip Deep MD4



DEFDG99C
Grip Deep 99C



DEFDG210S
Grip Deep 210S



DEFDG150*
Grip Deep 150



DEFDG222
Grip Deep 222



DEFDG150A
Grip Deep 150A

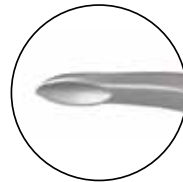

DEFDG151
Grip Deep 151



DEFDG65
Grip Deep 65
No serrations



DEFDGMD3
Grip Deep MD3



DEFDG845
Grip Deep 845
No serrations

Extracting Forceps Stainless Steel - Petite, Spring Handle

Miltex® Extracting Forceps are crafted from the finest quality German Stainless Steel.

REF	Description – Petite	Size
DEF17S	17S Petite Extracting Forceps	4-1/2"
DEF23S	23S Petite Extracting Forceps	4-1/2"
DEF150 1/2S	150 1/2S Petite Extracting Forceps	4-1/2"
DEF151 1/2S	115 1/2S Petite Extracting Forceps	4-1/2"
DEFA	A Petite Tooth Extracting Forceps	4-1/2"
DEFB	B Petite Tooth Extracting Forceps	4-1/2"
DEFC	C Petite Tooth Extracting Forceps	4-1/2"
DEFE	E Petite Tooth Extracting Forceps	4-1/2"
DEFF	F Petite Tooth Extracting Forceps	4-1/2"
DEFH	H Petite Tooth Extracting Forceps	4-1/2"

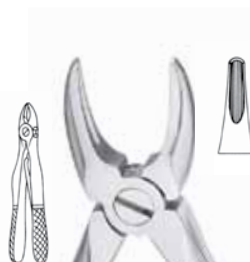

Items in **bold** represent the most popular patterns

Extracting Forceps - English Pattern, Petite, no Spring

REF	Description	Size
DEF13	13 Extracting Forceps	4-1/2"
DEF22	22 Extracting Forceps	4-1/2"
DEF33	33 Extracting Forceps	4-1/2"
DEF73	73 Extracting Forceps	4-1/2"
DEF74	74 Extracting Forceps	4-1/2"
DEF74N	74N Extracting Forceps	4-1/2"



DEF13
Universal



DEF22
Universal



DEF33



DEF73
Universal



DEF74



DEF74N
Narrow Beak

Extracting Forceps - Mead Pattern, Petite, no Spring

REF	Description	Size
DEFMD1	MEAD Extracting Forceps	4-1/2"
DEFMD2	MEAD Extracting Forceps	4-1/2"
DEFMD3	MEAD Extracting Forceps	4-1/2"
DEFMD4	MEAD Extracting Forceps	4-1/2"



DEFMD1
Universal



DEFMD2
Universal



DEFMD3
Universal



DEFMD4
Universal



Extracting Forceps - Petite, no Spring

REF	Description – Petite	Size
DEF16S	16S Petite Extracting Forceps	4-1/2"
DEF150S	150S Petite Extracting Forceps	4-1/2"
DEF150XAS	150XAS Extracting Forceps	4-1/2"
DEF151S	151S Petite Extracting Forceps	4-1/2"
DEF151XAS	151XAS Extracting Forceps	4-1/2"



DEF16S
Cow Horn



DEF150S
Universal



DEF150XAS
Split Beaks



DEF151S
Universal



DEF151XAS
Split Beaks,
Serrated

Extracting Forceps

Miltex® Extracting Forceps are crafted from the finest quality German Stainless Steel.

REF	Description	Type	Size
DEF10S	10S Extracting Forceps	small beaks	6-1/2"
DEF16	16 Extracting Forceps	cow horn	6-1/2"
DEF17	17 Extracting Forceps	-	6-1/2"
DEF23	23 Extracting Forceps	cow horn	6-1/2"
DEF85A	85A Extracting Forceps	anterior	6-1/2"
DEF88L	88L Extracting Forceps	left	6-1/2"
DEF210S	210S Extracting Forceps	small beaks	6-1/2"



DEF10S
Universal



DEF16
Universal; Cow Horn



DEF17
Universal

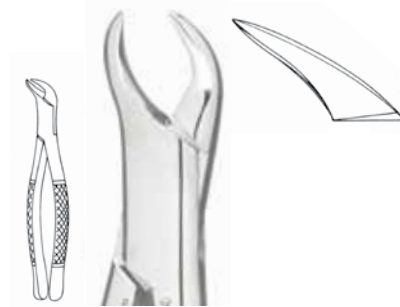

DEF23
Universal; Cow Horn

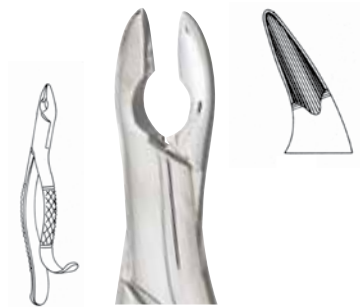

DEF85A
Universal

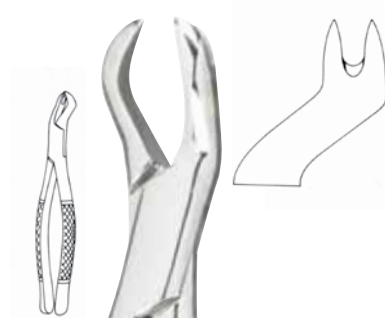

DEF88L
Left

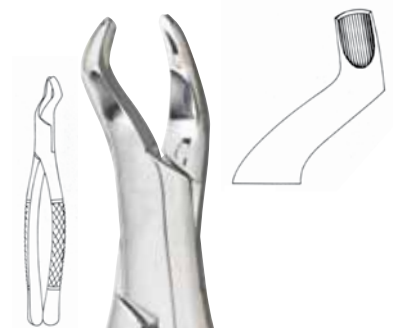

DEF210S
Universal

Extracting Forceps Stainless Steel

REF	Description	Type	Size
DEF1STD	1 Standard Extracting Forceps	-	6-1/2"
DEF6	6 Extracting Forceps	splitting/separating	6-1/2"
DEF62	62 Extracting Forceps	-	6-1/2"
DEF69	69 Extracting Forceps	-	6-1/2"
DEF101	101 Extracting Forceps	-	6-1/2"
DEF116	WITZEL Root Splinter Forceps	lower	6-1/2"
DEF120	WITZEL Root Splinter Forceps	upper	6-1/2"
DEF150	150 Extracting Forceps	-	6-1/2"
DEF150A	150A Extracting Forceps	anterior	6-1/2"
DEF150AS	150AS Extracting Forceps	anterior, split beaks	6-1/2"
DEF151	151 Extracting Forceps	-	6-1/2"
DEF151A	151A Extracting Forceps	anterior	6-1/2"
DEF151AS	151AS Extracting Forceps	anterior, split beaks	6-1/2"

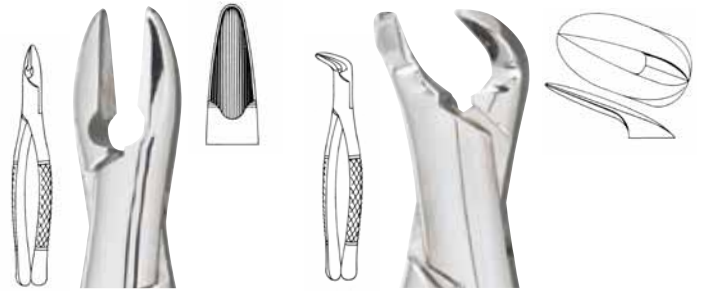

DEF1STD

DEF6
Splitting and
Separating

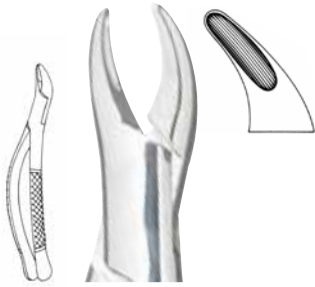

DEF62
Universal



DEF69



DEF101
Universal



DEF116
Universal



DEF120
Universal



DEF150
Universal



DEF150A
Universal; Parallel Beaks

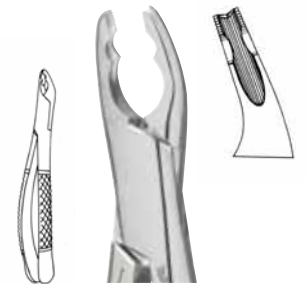

DEF150AS
Anteriors; Split Beaks; Serrated



DEF151
Universal

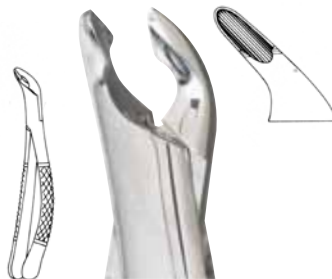

DEF151A
Parallel Beaks

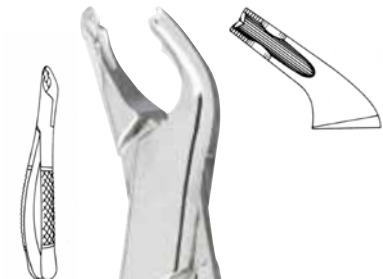

DEF151AS
Lower Anteriors; Split Beaks; Serrated

Extracting Forceps, Flame-Plated, Tungsten Carbide Beaks

This unique process makes the carbide an integral part of the beak. Handle tips are 24kt gold-plated for easy identification. Millex® Extracting Forceps are far superior to ordinary stainless steel extracting forceps.

- Better Grip
- Longer Wear
- Permanent Serrations

REF	Description	Type	Size
DEF1STDTC	1 Standard Tooth Extracting Forceps	serrated, carbide beaks	6-1/2"
DEF17TC	17TC Extracting Forceps	serrated, carbide beaks	6-1/2"
DEF150TC	150TC Extracting Forceps	serrated, carbide beaks	6-1/2"
DEF150STC	150STC Petite Extracting Forceps	serrated, carbide beaks	6-1/2"
DEF151TC	151TC Extracting Forceps	serrated, carbide beaks	6-1/2"
DEF151STC	151STC Petite Extracting Forceps	serrated, carbide beaks	6-1/2"
DEF53LTC	53LTC Extracting Forceps	serrated, carbide beaks	6-1/2"



DEF1STDTC

DEF17TC
Universal

DEF150TC
Universal

DEF150STC
Universal

DEF151TC
Universal

DEF151STC
Universal

DEF53LTC
Left

Tartar Removal Forceps

Tartar Removal Forceps are often used when there is an excessive amount of tartar build up on dog's teeth. The long tip is placed behind the tooth while the curved portion is placed at the top of the tooth on the front side. The clinician will then apply gentle pressure and pull down the front of the forceps. Tartar will then be chipped off by this movement. These instruments are NOT designed for feline teeth nor are they an acceptable replacement for proper cleaning utilizing hand and ultrasonic scalers. This tool is strictly for the removal of large bits of tartar and not for basic tartar build up.

REF	Description	Size
6051	Tartar Removal Forceps	4-1/2" (11.4 cm)
6052	Tartar Removal Forceps	5-1/2" (14 cm)



6051



6052

Bone Files

REF	Description	Type	Length
TKSC910	SCHLUGER 9-10 File	Tactile Tone double end	-
TKSU12	SUGERMAN 1-2 File	Tactile Tone double end	-
TKSU34	SUGERMAN 3-4 File	Tactile Tone double end	-
40-1370	Bone File	double end No. 10 pattern, plain serrations	7" (17.8 cm)
40-1371	Bone File	double end No. 33 pattern, plain serrations	7" (17.8 cm)
40-1375	Bone File	double end No. 64 - Miller pattern, plain serrations	7" (17.8 cm)

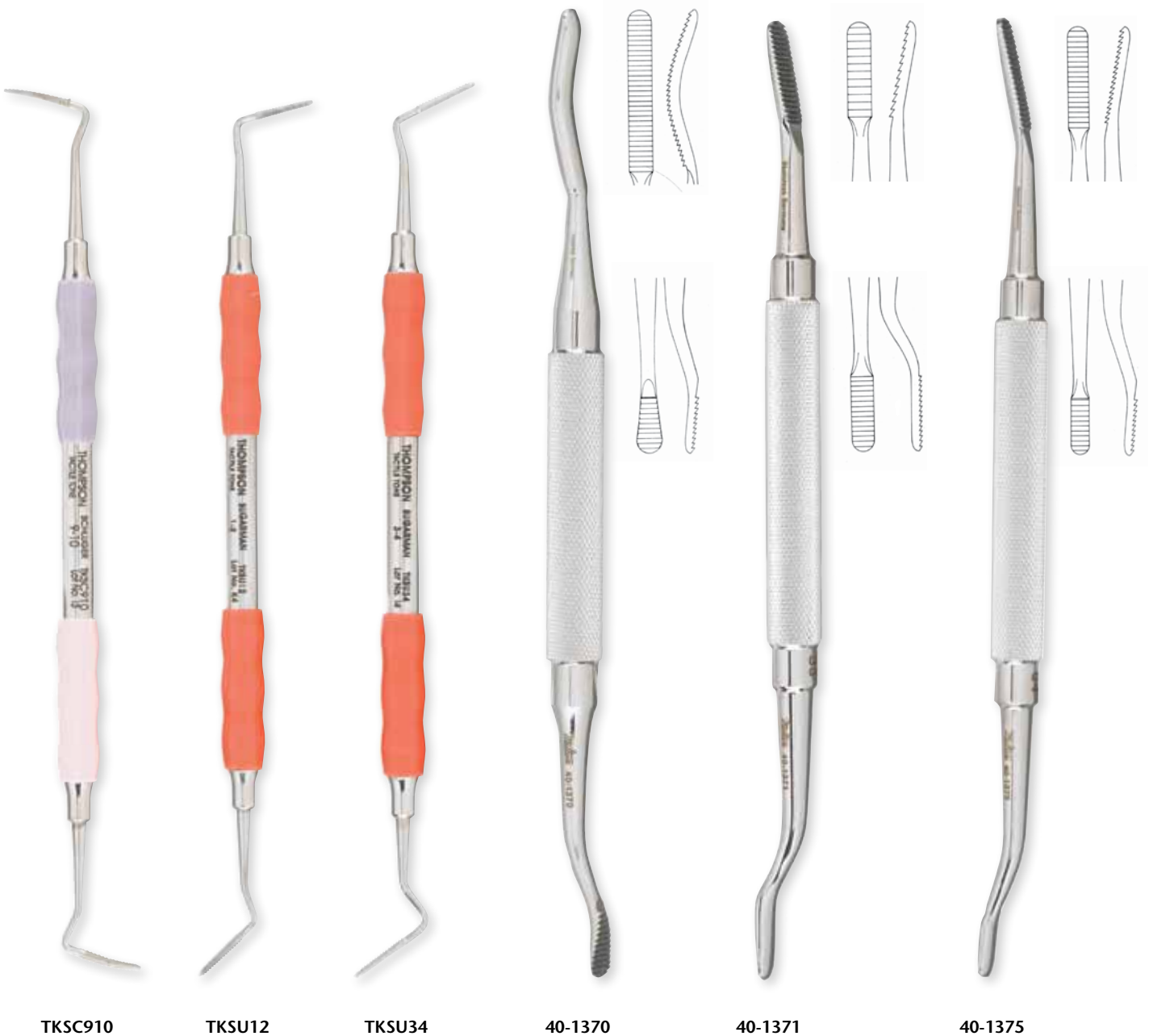

Bone Files

REF	Description	Type	Length
40-1380	Bone File	double end No. 45 - Miller pattern, plain serrations	7" (17.8 cm)
40-1381	Bone File	double end No. 12 - Howard pattern, plain serrations	7" (17.8 cm)
40-1382	Bone File	double end No. 12A - Howard pattern, one end plain, other serrated	7" (17.8 cm)
40-1385	Bone File	double end No. 12CA - Howard (BELL) pattern, cross serration	7" (17.8 cm)
40-2800	POLOKOFF Bone File	double end, narrow pattern	7-1/4" (18.4 cm)
40-2801	POLOKOFF Bone File	short head, fine serrations	6" (15.2 cm)
40-2802	POLOKOFF Bone File	long head, medium serrations	6-1/2" (16.5 cm)



40-1380

40-1381

40-1382

40-1385

40-2800

40-2801

40-2802

Bone Chisels

REF	Description
62-2	No. 1 GARDNER Bone Chisel
62-4	No. 2 GARDNER Bone Chisel
62-6	No. 5 GARDNER Bone Chisel
62-8	No. 5R GARDNER Bone Chisel
70-144	OCHSENBEIN CHISEL #1
70-146	OCHSENBEIN CHISEL #2
70-148	OCHSENBEIN 3 DE #2 HANDLE
70-150	OCHSENBEIN Periodontal Chisel No. 4
TKOC3	OCHSENBEIN #3 Chisel Tactile Tone double end
TKOC4	OCHSENBEIN #4 Chisel Tactile Tone double end
UKK29	CHISEL KIRKLAND 29



Graduated Chisels

Graduated chisels have reference graduation marks and are used to widen ridges. Graduated chisels are available in straight and curved patterns.

REF	Description
62-20	Chisel, Graduated, Straight, 3.8 mm (7-10-13-15-18mm markings)
62-21	Chisel, Graduated, Curved, 3.8 mm (7-10-13-15-18mm markings)
62-22	Chisel, Graduated, Straight, 7.5 mm (7-10-13-15-18mm markings)
62-23	Chisel, Graduated, Curved, 7.5 mm (7-10-13-15-18mm markings)



Freer Chisels

The extremely sharp tips of Freer chisels make it possible to incise and widen ridges. Freer chisels are available in single or double edge.

REF	Description
62-40	Chisel, Freer, Single Cut Blade, 2 mm
62-41	Chisel, Freer, Single Cut Blade, 4 mm
62-42	Chisel, Freer, Single Cut Blade, 6 mm
62-43	Chisel, Freer, Double Cut Blade, 2 mm
62-44	Chisel, Freer, Double Cut Blade, 4 mm
62-45	Chisel, Freer, Double Cut Blade, 6 mm



Osteotome

Osteotomes are specially designed for progressive circumferential (circular) expansion.

REF	Description
62-100	Osteotome, Sharp, 2 mm
62-101	Osteotome, Sharp, 2.7 mm
62-102	Osteotome, Sharp, 3.25 mm
62-103	Osteotome, Sharp, 3.8 mm
62-104	Osteotome, Blunt, 3 mm
62-105	Osteotome, Blunt, 4 mm
62-106	Osteotome, Blunt, 5 mm

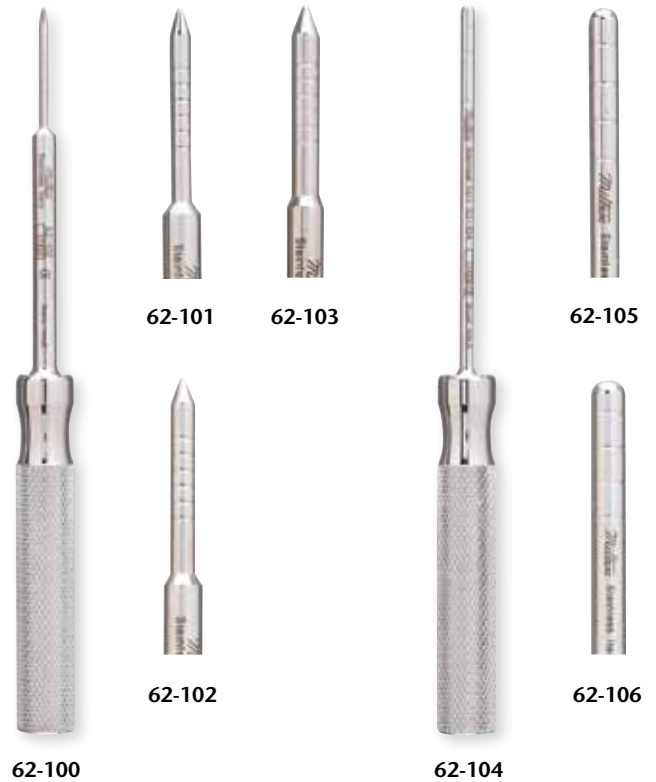

Progressive Osteotome

Progressive osteotomes can be used to prepare an implant site in maxillary areas with bone densities 3 or 4.

REF	Description
62-120	Osteotome, Progressive, Concave, 1.6 mm
62-121	Osteotome, Progressive, Concave, 1.9 mm
62-122	Osteotome, Progressive, Concave, 2.8 mm
62-123	Osteotome, Progressive, Concave, 3.1 mm
62-124	Osteotome, Progressive, Concave, 3.9 mm
62-125	Osteotome, Progressive, Concave, 5.5 mm



Sinus Lift Instruments

Sinus lift instruments aid in lifting the sinus cavity for implant site preparation. Elevators and curettes are also available to assist this procedure.

REF	Description
62-180	Elevator, Sinus, Lift No. 1
62-181	Elevator, Sinus, Lift No. 2
62-182	Elevator, Sinus, Lift No. 3
62-183	Elevator, No. B1
62-184	Elevator, No. B2
62-185	Elevator, No. B3
62-190	Curette, Sinus, Lift No. 1
62-191	Curette, Sinus, Lift No. 2
62-192	Curette, Sinus, Lift No. B1



62-180



62-181



62-182



62-183



62-184



62-185



62-190



62-191



62-192

Rongeurs

Rongeurs are crafted from the finest quality German grade stainless steel and are used to cut and shape bone.

REF	Description	Type	Length
17-4801	Micro FRIEDMAN Rongeur	curved, 1.3 mm jaw	5-1/2" (14 cm)
17D-4802	Micro FRIEDMAN Rongeur	90° angle, 1.3 mm jaw	5-1/2" (14 cm)
22D-422	Mini-BLUMENTHAL Oral Surgery Rongeur	25° angle	5-1/4" (13.3 cm)



17-4801

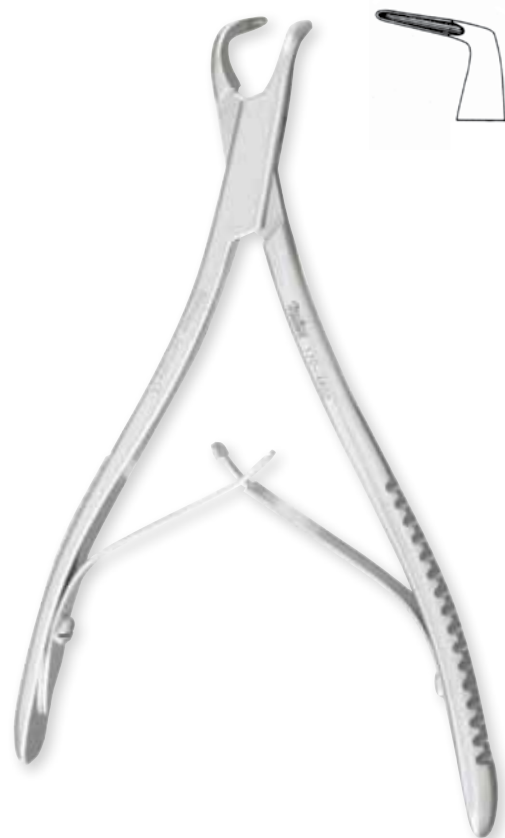

17D-4802



22D-422

Rongeurs

REF	Description	Type	Length
22D-424	Mini-BLUMENTHAL Rongeur	45° angled beaks	5" (12.7 cm)
22D-426	CLEVELAND Oral Surgery Rongeur	no. 5A pattern, side cutting	6-1/2" (16.5 cm)
22D-428	CLEVELAND Oral Surgery Rongeur	no. 5S pattern, side cutting	5-1/4" (13.3 cm)



22D-424



22D-426



22D-428

Rongeurs

REF	Description	Type	Size
22D-432	Oral Surgery Rongeur	no. 1 pattern, strong curved	6-1/2" (16.5 cm)
22-480	BLUMENTHAL Oral Surgery Rongeur	beaks at 30° angle	6" (15.2 cm)
22-486	Oral Surgery Rongeur	no. 4 pattern, slightly curved beaks	5-1/2" (14 cm)
22-488	Oral Surgery Rongeur	no. 4A pattern, slightly angled beaks	6-1/2" (16.5 cm)
22-490	CLEVELAND Oral Surgery Rongeur	no. 5 pattern, side cutting	6-3/4" (17.1 cm)



22D-432



22-480



22-486



22-488



22-490

Rongeurs

REF	Description	Type	Size
22-492	GARDNER Oral Surgery Rongeur	no. 6A pattern, end cutting	6-1/2" (16.5 cm)
22-494	FRIEDMAN Oral Surgery Rongeur	very delicate	5-1/2" (14 cm)
6081	Pig Tooth Nippers	with spring	5-1/2" (14 cm)



22-492



22-494



6081

Root Tip Forceps

REF	Description	Tip	Length
6-338	WILLIAMS Splinter Forceps	straight	5-1/2" (14 cm)
6-340	WILLIAMS Splinter Forceps	45° angle	5-1/2" (14 cm)
6-342	WILLIAMS Splinter Forceps	right angle	4-3/4" (12.1 cm)
6-350	PEET Splinter Forceps	double curve	4-3/4" (12.1 cm)
7-20	HALSTED Mosquito Forceps	jaws angled 45° on flat, extra delicate	4-1/2" (11.4 cm)
66-660	Silver Point Holding Forceps	grooved jaws, right angle	4-3/4" (12.1 cm)



6-338



6-340



6-342



6-350



7-20



66-660

College (Cotton) Pliers

REF	Description	Feature
017-27541	FLAGG Pliers	serrated beak
66-311	311 Dental Cotton (College) Pliers	forked tips, smooth
66-312A	312A Dental Cotton (Perry) Pliers	angled, serrated tips
66-317	317 Dental Cotton (College) Pliers	serrated tips
66-317A	317A Dental Cotton (College) Pliers	extra fine tips, serrated
66-317B	317B College Pliers, X-fine tips	serrated with long fine points
66-317S	317 Dental Cotton (College) Pliers	smooth tips
66-318	318 MERIAM Pliers	serrated tips
66-318-49	318-49 College Pliers, non-pinch	fine points, serrated
66-49	49 College Pliers, non-pinch	fine points, serrated
66-652	Cotton Pliers with lock	serrated tips
66-656	Cotton Pliers with lock	grooved tips



Corn Suture & Endodontic Pliers

REF	Description	Feature	Length
70-153	CORN Suture Pliers	serrated	6" (15.2 cm)
017-24200	Endodontic Pliers with lock	one grooved/one serrated beak	6" (15.2 cm)
017-24204	Endodontic Pliers	one grooved/one serrated beak	6" (15.2 cm)
017-24205	Endodontic Pliers	two grooved beaks	6" (15.2 cm)
017-24211	Endodontic Pliers with lock	extra fine, one grooved/one serrated beak	6" (15.2 cm)
017-24212	Endodontic Pliers	extra fine, one grooved/one serrated beak	6" (15.2 cm)



70-153



017-24200
017-24204



017-24205



017-24211
017-24212

Wound Dressing Products

Miltex® collagen wound dressing products are used to help control bleeding, develop blood clots and to protect the wound site in order for the healing process to begin. The Miltex® product offering includes HeliCote™, HeliPlug™ and HeliTape™. The Heli products are reabsorbed by the body within 10 to 14 days after placement.

These collagen products are packaged in individual clam shells with an easy to peel backing. This packaging reduces tray set up time and makes it easy for clinicians to open packages during procedures. The product is sterile and sold in packs of 10.

REF	Description	Size	Qty/Box
62-200	HeliTape	1" x 3" (2.5 cm x 7.5 cm)	10
62-201	HeliCote	3/4" x 1.5" (1.9 cm x 3.8 cm)	10
62-202	HeliPlug	3/8" x 3/4" (1 cm x 2 cm)	10

HeliTAPE™

Indications

- Used for dressing minor wounds
- Used to aid in the closure of graft sites
- Used to help repair the Schniderian Membrane

HeliCOTE™

Indications

- Used in palatal donor sites
- Used in mucosal flaps

HeliPLUG™

Indications

- Used to control bleeding and to develop blood clots in extraction sites
- Used to control bleeding and to develop blood clots in biopsy sites



MILTEX® ENDODONTIC INSTRUMENTS

Liberator Endo Files.....	296
Gates Glidden Drills	297
Sprint™ TCM - Torque Controlled Electric Endo Motor....	298
Union Broach® Files.....	299-302
Miltex® Files	303
Union Broach® Barbed Broaches.....	304
Union Broach® and Miltex® Reamers	305
Juniors, Endodilator™, Endo-Klean™ & Slide™ File Lubricant.....	306
Gutta Purcha & Paper Points.....	307
Tri-R Post™ System.....	308
Paste Carriers	309
Condensers/Pluggers.....	310
Endo Spreaders.....	311-312
Endo Forceps.....	313
Endo Block.....	314
Gutta Box	315
Root Canal Cabinets.....	316-317
Endo Blocks	318

Liberator® Endodontic Files

Liberator® Rotary Nickel-Titanium Endodontic Files incorporate a unique straight blade design and a manufacturing process that eliminates the traditional helical flutes found on virtually all rotary endodontic files. The result is that Liberator® files will not self-thread into a canal, a major contributor to file separation.

Liberator® files provide a level of safety, control and effectiveness that is unprecedented in rotary nickel-titanium files.

Apical Shaping Files

.02 Taper - 6 files per package

Tip	21 mm	25 mm
15	012-28001	012-28015
20	012-28002	012-28016
25	012-28003	012-28017
30	012-28004	012-28018
35	012-28005	012-28019
40	012-28006	012-28020
15-40	012-28007	012-28021
45	012-28008	012-28022
50	012-28009	012-28023
55	012-28010	012-28024
60	012-28011	012-28025
70	012-28012	012-28026
80	012-28013	012-28027
45-80	012-28014	012-28028

.04 Taper - 6 files per package

Tip	21 mm	25 mm
15	012-28101	012-28112
20	012-28102	012-28113
25	012-28103	012-28114
30	012-28104	012-28115
35	012-28105	012-28116
40	012-28106	012-28117
15-40	012-28107	012-28118
45	012-28108	012-28119
50	012-28109	-
60	012-28110	-
70	012-28111	-

.06 Taper - 6 files per package

Tip	21 mm	25 mm
15	012-28201	012-28212
20	012-28202	012-28213
25	012-28203	012-28214
30	012-28204	012-28215
35	012-28205	012-28216
40	012-28206	012-28217
15-40	012-28207	012-28218
45	012-28208	012-28219
50	012-28209	-
60	012-28210	-
70	012-28211	-
70	012-28111	-

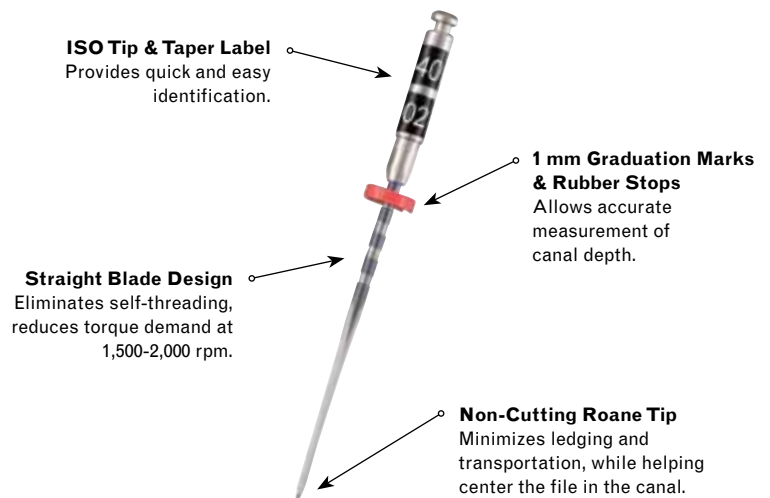

Gates Glidden Drills

Gates Glidden drills are designed with a flame-shaped, boring head on a slender shaft. These drills reduce the curvature in the orifice of the canal, which allows for greater access to the canal for cleaning and obturation. Gates Glidden drills are sold 6 per pack.

No.	Tip	Taper	Length
012-28401	118 (RGG #1)	.08	13 mm
012-28402	94 (RGG #2)	.08	16 mm
012-28403	70 (RGG #3)	.08	19 mm
012-28405	70-118	.08	Assorted

6 per package

Gates Glidden & Mini-Entrée Gates Glidden Drills

No.	RA - 32 mm Item No.	RA - 28 mm Item No.
1	017-19300	017-19400
2	017-19301	017-19401
3	017-19302	017-19402
4	017-19303	017-19403
5	017-19304	017-19404
6	017-19305	017-19405
Assorted	017-19306	017-19406

6 per package



Peeso Reamers are designed with long, sharp flutes that provide rapid widening of the coronal area. These reamers are used to reduce the curvature of the canal and for post preparation. They are sold 6 per pack.

Peeso Reamers (RA) - 6 per package

No.	RA- 32 mm Item No.
1	017-19350
2	017-19351
3	017-19352
4	017-19353
5	017-19354
6	017-19355
Assorted	017-19356



Endo-Gripper™ - Slow Speed Handpiece for Finger Instruments

This unique handpiece was designed to provide clinicians with the "best of both worlds" by combining a high-tech device with the traditional finger instrumentation and procedures.

- Implement a 45 degree turn technique in a quick, efficient manner.
- Reduces fatigue by cutting procedure times.
- Easy to operate - indexable and features push-button loading

REF	Description
017-36352	"E" for E-type low-speed (Universal/European)



The Tardie™ - Slow Speed and High Torque Handpiece for Rotary Instruments

The Tardie™ slow speed handpiece system was developed for endodontic procedures where slow and controlled speed (150 to 350 rpm) with high torque is mandatory.

- *Faster procedures to reduce fatigue*
- *Greater Control with a 64:1 Gear Reduction*

REF	Description
017-36400	20,000 rpm Airmotor (only)
017-36401	Reduction Adapter 64:1 (only)
017-36402	Latch Head (only)
017-36403	Tardie Complete System (Airmotor, adapter and angle)
017-36404	Tardie Adapter and Angle (see picture)
017-36406	Ball Bearing Latch Head



The Sprint™ TCM - Torque controlled Electric Endodontic Motor

- Keyboard Panel with digital readout
- 2 Selectable Torque Modes - One mode for allowable torque; and the other for when the unit reverses directions
- Selectable Torque levels from 2 to 50 gm/cm to prevent file separation.
- 3 settings: 1:1, 8:1 and 10:1
- Speed range of 75 to 800 rpm
- The preset torque control automatically reverses before too much torque is reached
- Autoclavable Micro Hand Held Motor

Sets

REF	Description
017-36295	Sprint TCM and Tardie 10
017-36296	Sprint TCM and Tardie El 8:1 HP

Components

REF	Description
017-36300	Sprint TCM
017-36307	Tardie 10:1 Reduction HP
017-36308	Tardie Elite 8:1 Reduction HP



Union Broach® Flex-R® Files - Flexible Roane Tip Stainless Steel File

Flex-R® Files are our most popular Union Broach® endodontic hand file. The files are designed with a non-cutting "Roane" tip designed by Dr. James Roane. Made from high quality stainless steel, the Flex-R® file ensures the most comprehensive cleaning and shaping of the root canal.

FEATURES

- Made from the purest stainless steel available
- Non-cutting Roane tip
- Handles are ISO color coded and printed with the ISO file tip size
- Available in a variety of sizes, lengths and rubber stop configurations

BENEFITS

- Helps ensure strength and quality of product
- Reduces chance of file ledging or occurrence of transportation
- Allows for easy identification of file

Stainless Steel (.02 taper) - 6 per pack

Instrument Size	21 mm	21 mm w/Stops	25 mm	25 mm w/Stops	31 mm	31 mm w/Stops
8	012-14002	012-S4002	012-14061	012-S4061	012-14181	-
10	012-14003	012-S4003	012-14062	012-S4062	012-14182	-
15	012-14004	012-S4004	012-14063	012-S4063	012-14183	-
20	012-14005	012-S4005	012-14064	012-S4064	012-14184	-
25	012-14006	012-S4006	012-14065	012-S4065	012-14185	-
30	012-14007	012-S4007	012-14066	012-S4066	012-14186	-
35	012-14008	012-S4008	012-14067	012-S4067	012-14187	-
40	012-14009	012-S4009	012-14068	012-S4068	012-14188	-
45	012-14011	-	012-14070	-	012-14190	-
50	012-14012	012-S14012	012-14071	-	012-14191	-
55	012-14013	012-S14013	012-14072	-	012-14192	-
60	012-14014	-	012-14073	-	012-14193	-
70	012-14015	-	012-14074	-	012-14194	-
80	012-14016	-	012-14075	-	012-14195	-
90	-	-	012-14077	-	012-14197	-
100	-	-	012-14078	-	012-14198	-
110	-	-	012-14079	-	012-14199	-
120	-	-	012-14081	-	012-14201	-
130	-	-	012-14082	-	012-14202	-
140	-	-	012-14083	-	012-14203	-
15-40*	012-14010	012-S4010	012-14069	012-S4069	012-14189	012-S4189
45-80*	012-14017	012-S4070	012-14076	012-S4076	012-14196	012-S4196
90-110*	-	-	012-14080	-	012-14200	-
120-140*	-	-	-	-	012-14204	-
90-140*	-	-	-	-	012-14205	-

* Assorted



Union Broach® Mor-Flex®

Mor-Flex® files are “K” type files with a cutting tip design. The files allow for comprehensive cleaning and shaping of the canal. The flat end of the handle may be accurately used as a radiographic landmark on X-rays. Mor-Flex® files are made from the purest stainless steel which helps ensure the material strength of the file.

FEATURES

- Made from the purest stainless steel available
- Cutting tip
- Handles are ISO color coded and printed with the ISO file tip size
- Available in a variety of sizes and lengths

BENEFITS

- Helps ensure strength and quality of product
- Allows for more aggressive removal of material from the canal
- Allows for easy identification of file

K-Type Files (.02 taper) - 6 per pack

Standardized

Instrument Size	21 mm No.	21 mm w/Stops No.	25 mm No.	25 mm w/ Stops No.	31 mm No.	31 mm w/Stops No.
6	012-10001	012-S0001	012-10060	012-S0060	012-10180	012-S0180
8	012-10002	012-S0002	012-10061	012-S0061	012-10181	012-S0181
10	012-10003	012-S0003	012-10062	012-S0062	012-10182	012-S0182
15	012-10004	012-S0004	012-10063	012-S0063	012-10183	012-S0183
20	012-10005	012-S0005	012-10064	012-S0064	012-10184	012-S0184
25	012-10006	012-S0006	012-10065	012-S0065	012-10185	012-S0185
30	012-10007	012-S0007	012-10066	012-S0066	012-10186	012-S0186
35	012-10008	012-S0008	012-10067	012-S0067	012-10187	-
40	012-10009	012-S0009	012-10068	012-S0068	012-10188	-
45	012-10011	012-S0011	012-10070	012S0070	012-10190	-
50	012-10012	012-S0012	012-10071	012S0071	012-10191	-
55	012-10013	012-S0013	012-10072	012S0072	012-10192	-
60	012-10014	012-S0014	012-10073	012S0073	012-10193	-
70	012-10015	012-S0015	012-10074	012S0074	012-10194	-
80	012-10016	012-S0016	012-10075	012S0075	012-10195	-
90	-	-	012-10076	-	012-10197	-
100	-	-	012-10077	-	012-10198	-
110	-	-	012-10078	-	012-10199	-
120	-	-	012-10079	-	012-10201	-
130	-	-	-	-	012-10202	-
140	-	-	-	-	012-10203	-
15-40*	012-10010	012-S0010	012-10069	012-S0069	012-10189	012-S0189
45-80*	012-10017	012-S0011	012-10076	012-S0076	012-10196	012-S0196
90-110*	-	-	-	012-S0080	-	-
90-140*	-	-	-	-	012-10205	-
120-140*	-	-	-	-	012-10204	-

* Assorted



Union Broach® Sharpie® Hedstrom Files

Sharpie® Hedstrom files are good for use on teeth with irregular walls or for removing instruments (i.e. separated files). Sharpie® Hedstrom files tend to cut more aggressively than reamers or "K" type files.

FEATURES

Made from the purest stainless steel available
Handles are ISO color coded and printed with the ISO file tip size
Available in a variety of sizes and lengths

BENEFITS

Helps ensure strength and quality of product
Allows for easy identification of file

Stainless Steel (.02 taper) - 6 per pack

Instrument Size	21 mm	21 mm w/Stops	25 mm	25 mm w/Stops	31 mm	31 mm w/Stops
10	012-11000	012-S1000	012-11059	012-S1059	012-11179	-
15	012-11001	012-S1001	012-11060	012-S1060	012-11180	-
20	012-11002	012-S1002	012-11061	012-S1061	012-11181	-
25	012-11003	012-S1003	012-11062	012-S1062	012-11182	-
30	012-11004	012-S1004	012-11063	012-S1063	012-11183	-
35	012-11005	012-S1005	012-11064	012-S1064	012-11184	-
40	012-11006	012-S1006	012-11065	012-S1065	012-11185	-
45	012-11008	-	012-11067	-	012-11187	-
50	012-11009	-	012-11068	-	012-11188	-
55	012-11010	-	012-11069	-	012-11189	-
60	012-11011	-	012-11070	-	012-11190	-
70	012-11012	-	012-11071	-	012-11191	-
80	012-11013	-	012-11072	-	012-11192	-
90	012-11015	-	012-11074	-	012-11194	-
100	012-11016	-	012-11075	-	012-11195	-
110	-	-	012-11076	-	012-11196	-
120	-	-	-	-	012-11198	-
130	-	-	-	-	012-11199	-
140	-	-	-	-	012-11200	-
15-40*	012-11007	012-S1007	012-11066	012S1066	012-11186	012-S1186
45-80*	012-11014	012-S1014	012-11073	012-S1073	012-11193	012-S1193
90-110*	-	-	012-11077	-	012-11197	-
120-140*	-	-	-	-	012-11201	-
90-140*	-	-	-	-	012-11202	-

* Assorted



Union Broach® Onyx-R® Files (Nickel Titanium Flex-R® File)

Onyx-R® files are made from nickel titanium which allows the files to be more flexible in tight curvature canals. They are designed with a non-cutting "Roane" tip designed by Dr. James Roane.

FEATURES

- Nickel Titanium is more flexible
- Non-cutting Roane tip
- Handles are ISO color coded and printed with the ISO file tip size
- Available in a variety of sizes, lengths and rubber stop configurations

BENEFITS

- Pre-bending files is not necessary and follow the existing canal path
- Reduces chance of file ledging or occurrence of transportation
- Allows for easy identification of file

Nickel Titanium (.02 taper) - 6 per pack

Standard				
Instrument Size	21 mm No.	21 mm w/Stops	25 mm No.	25 mm w/Stops
15	012-15001	012-S5001	012-15061	012-S5061
20	012-15002	012-S5002	012-15062	012-S5062
25	012-15003	012-S5003	012-15063	012-S5063
30	012-15004	012-S5004	012-15064	012-S5064
35	012-15005	012-S5005	012-15065	012-S5065
40	012-15006	012-S5006	012-15066	012-S5066
45	012-15008	-	012-15068	012-S5068
50	012-15009	-	012-15069	-
55	012-15010	-	012-15070	-
60	012-15011	-	012-15071	-
70	012-15012	-	012-15072	-
80	012-15013	-	012-15073	-
15-40*	012-15007	012-S5007	012-15067	012-S5067
45-80*	012-15014	012-S5014	012-15074	012-S5074

* Assorted



Union Broach® Onyx-H™ Files (Nickel Titanium Hedstrom Files)

Onyx-H™ files are made from nickel titanium which allows the files to be more flexible in tightly curved canals.

FEATURES

- Handles are ISO color coded and printed with the ISO file tip size
- Available in a variety of sizes, lengths and rubber stop configurations

BENEFITS

- Allows for easy identification of file

Nickel Titanium (.02 taper) - 6 per pack

Standard		
Instrument Size	21 mm No.	25 mm No.
15	012-15080	012-15100
20	012-15081	012-15101
25	012-15082	012-15102
30	012-15083	012-15103
35	012-15084	012-15104
40	012-15085	012-15105
45	012-15087	012-15107
50	012-15088	012-15108
55	012-15089	012-15109
60	012-15090	012-15110
70	012-15091	012-15111
80	012-15092	012-15112
15-40*	012-15086	012-15106
45-80*	012-15093	012-15113

* Assorted



Miltex® K-Files

Miltex® K-files have a large helix angle which increases the cutting efficiency in the linear filing action as opposed to a reaming action.

FEATURES

Handles are ISO color coded and printed with the ISO file tip size
Available in a variety of sizes, lengths and rubber stop configurations

BENEFITS

Allows for easy identification of file

Stainless Steel (.02 taper) - 6 per pack

Standardized			
Instrument Size	21 mm	25 mm	31 mm
6	DKF21/06	DKF25/06	DKF31/06
8	DKF21/08	DKF25/08	DKF31/08
10	DKF21/10	DKF25/10	DKF31/10
15	DKF21/15	DKF25/15	DKF31/15
20	DKF21/20	DKF25/20	DKF31/20
25	DKF21/25	DKF25/25	DKF31/25
30	DKF21/30	DKF25/30	DKF31/30
35	DKF21/35	DKF25/35	DKF31/35
40	DKF21/40	DKF25/40	DKF31/40
45	DKF21/45	DKF25/45	DKF31/45
50	DKF21/50	DKF25/50	DKF31/50
55	DKF21/55	DKF25/55	DKF31/55
60	DKF21/60	DKF25/60	DKF31/60
70	DKF21/70	DKF25/70	DKF31/70
80	DKF21/80	DKF25/80	DKF31/80
15-40*	DKF21/15-40	DKF25/15-40	DKF31/15-40
45-80*	DKF21/45-80	DKF25/45-80	DKF31/45-80

* Assorted



Miltex® Hedstrom Files

Miltex® H-files have excellent cutting efficiency in a push and pull stroke.

FEATURES

Handles are ISO color coded and printed with the ISO file tip size
Available in a variety of sizes, lengths and rubber stop configurations

BENEFITS

Allows for easy identification of file

Stainless Steel (.02 taper) - 6 per pack

Standardized		
Instrument Size	21 mm	25 mm
10	DHF21/10	DHF25/10
15	DHF21/15	DHF25/15
20	DHF21/20	DHF25/20
25	DHF21/25	DHF25/25
30	DHF21/30	DHF25/30
35	DHF21/35	DHF25/35
40	DHF21/40	DHF25/40
45	-	DHF25/45
50	-	DHF25/50
55	-	DHF25/55
60	-	DHF25/60
70	-	DHF25/70
80	-	DHF25/80
15-40*	DHF21/15-40	DHF25/15-40
45-80	-	DHF25/45-80

* Assorted



Miltex® Hi-5® File

Miltex® Hi-5® files are designed with helical ground flutes. These files have a strong and stiff pentagonal cross section good for penetration in small or calcified canals. Made from high quality stainless steel, Miltex® Hi-5® files provide strength and ensure proper cleaning and shaping.

FEATURES

- Made from the purest stainless steel available
- Stiff pentagon cross section
- Handles are ISO color coded and printed with the ISO file tip size
- Available in a variety of sizes and lengths

BENEFITS

- Helps ensure strength and quality of product
- Resilient and effective cutting instruments
- Allows for easy identification of file

Stainless Steel - 6 per pack
Standardized

Instrument Size	21 mm No.	25 mm No.
6	012-26001	012-26005
8	012-26002	012-26006
10	012-26003	012-26007
15	012-26004	012-26008
06-15*	012-26009	012-26010

* Assorted



Cross Section Comparison

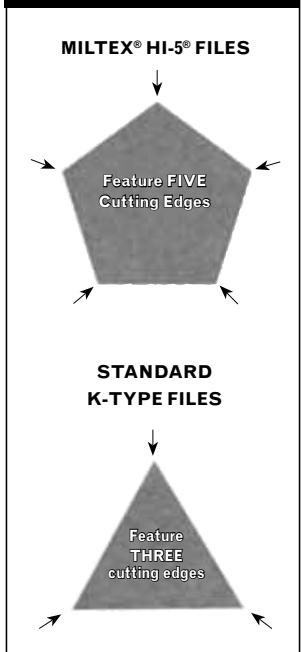

Union Broach® Barbed Broaches

- Manufactured from stainless steel—12 Per Box.
- Used to remove soft tissue in the canal.
- May also be used to remove intra-canal dressings.

REF	Description
012-13001	Coarse
012-13002	Medium
012-13003	Fine
012-13004	X-Fine
012-13005	XX-Fine
012-13006	XXX-Fine
012-13007	XXXX-Fine
012-13008	Assorted



Union Broach® Reamers

Union Broach® Reamers are well suited for removing old gutta percha fillings and may be used as a paste filler to place cement near the apex. Reamers are used in either a revolving or a filing action.

- Handles are ISO color coded and printed with the ISO file tip size – Allows for easy identification of file
- Available in a variety of sizes, lengths and rubber stop configurations

Stainless Steel (.02 taper) - 6 per pack

Standardized				
Instrument Size	21 mm No.	25 mm No.	25 mm W/Stops	31 mm
8	012-12002	012-12061	-	012-12181
10	012-12003	012-12062	-	012-12182
15	012-12004	012-12063	-	012-12183
20	012-12005	012-12064	-	012-12184
25	012-12006	012-12065	-	012-12185
30	012-12007	012-12066	-	012-12186
35	012-12008	012-12067	-	012-12187
40	012-12009	012-12068	-	012-12188
45	012-12011	012-12070	-	012-12190
50	012-12012	012-12071	-	012-12191
55	012-12013	012-12072	-	012-12192
60	012-12014	012-12073	-	012-12193
70	012-12015	012-12074	-	012-12194
80	012-12016	012-12075	-	012-12195
90	-	-	-	012-12197
100	-	-	-	012-12198
110	-	-	-	012-12199
120	-	-	-	012-12201
130	-	-	-	012-12202
140	-	-	-	012-12203
15-40	012-12010	012-12069	-	012-12189
45-80	012-12017	012-12076	012-S2076	012-12196



Miltex® Reamers

Miltex® Reamers are well suited for removing old gutta percha fillings and may be used as a paste filler to place cement near the apex. Reamers are used in either a revolving or a filing action.

- Handles are ISO color coded and printed with the ISO file tip size – Allows for easy identification of file
- Available in a variety of sizes and lengths – Meets the needs of dental professionals

Stainless Steel - 6 per pack

Standardized		
Instrument Size	21 mm	25 mm
8	DR21/08	DR25/08
10	DR21/10	DR25/10
15	DR21/15	DR25/15
20	DR21/20	DR25/20
25	DR21/25	DR25/25
30	DR21/30	DR25/30
35	DR21/35	DR25/35
40	DR21/40	DR25/40
45	DR21/45	DR25/45
50	DR21/50	DR25/50
55	DR21/55	DR25/55
60	DR21/60	DR25/60
70	DR21/70	DR25/70
80	DR21/80	DR25/80
15-40*	DR21/15-40	DR25/15-40
45-80*	DR21/45-80	DR25/45-80

* Assorted



Juniors

Juniors are disposable pipettes filled with different endodontic medicaments. Juniors allow for precise dispensing every time. The squeezable bulb eliminates the need to transfer solutions from container to syringe.

REF	Product Name	Description	Package
033-39210P	Slide Juniors	File Lubricant w/10% urea peroxide	35/box
033-39211P	Slide SH Juniors	Slide w/3% Sodium Hypochlorite	35/box
017-39211P	Endodilator Juniors	15% EDTA	35/box
033-39214P	Endo-Klean™ Juniors	2.5% Sodium Hypochlorite	35/box
033-39215P	Lube Juniors	File Lubricant w/NaOH and EDTA	35/box



Endodilator™

Endodilator™ solution irrigates and softens dentin and chelates root canal walls. Endodilator solution contains 15% EDTA and superficially dissolves root canal walls without harming vital tissue. It is self-limiting and sterilizing and active at a neutral pH level. Endodilator solution is inactivated by oxygen or chlorine.

REF	Description
017-39211	60 ml Bottle



017-39211

Endo-Klean™

Endo-Klean™ solution contains 2.5% sodium hypochlorite and cleans, irrigates and finishes root canals. Endo-Klean solution is intended as an irrigant in the exploration and debridement of root canals, leaving the canal dry and reducing the use of paper points.

REF	Description
033-39214	60 ml Bottle



033-39214

Slide™ - File Lubrication

Slide™ file lubrication cleans and lubricates the canal, reducing the chance of ledging. Slide file lubrication contains 10% urea peroxide in a gel base and is ideal for rotary instrumentation. Slide file lubrication was specifically formulated by Dr. Joseph Dogan to facilitate instrument movement and to remove debris from the root canal. Slide file lubrication also enhances file efficiency, disinfects and decreases fibrous apical blockage.

REF	Description
033-39210	60 ml Bottle



033-39210

Marked Gutta Percha and Paper Points

Miltex® Marked Gutta Percha points have millimeter markings on the cones to aid clinicians in identifying how deep in the canal the gutta percha is placed during the obturation procedure. Each radiopaque and cadmium-free gutta percha cone is marked at 19, 21, 23 and 25 millimeters from the tip. The gutta percha cones are hand-rolled with precision to ensure proper ISO specifications are met. Gutta percha cones are available in .02, .04 and .06 tapers in tip sizes from 15 to 140. Accessory points are also available unmarked. All gutta percha is sold in easy-to-dispense plastic trays in counts from 60 to 120 with a 4 year shelf life.

Miltex® paper points are made from a super-absorbent material that maximizes canal cleaning while minimizing residual fibers in the canal that can cause root canal failure and patient sensitivity. The paper points are sold in easy-to-dispense plastic trays in counts from 180 to 200 with a 3 year shelf life.

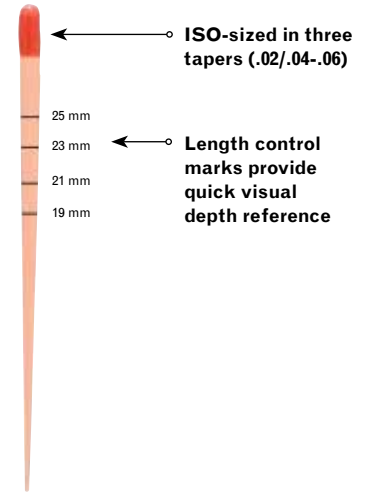

Marked Gutta Percha Points

Size	.02 mm Taper	.04 mm Taper	.06 mm Taper
	120/Slide Box REF	100/Slide Box REF	60/Slide Box REF
#15	017-51200	017-51220	017-51240
#20	017-51201	017-51221	017-51241
#25	017-51202	017-51222	017-51242
#30	017-51203	017-51223	017-51243
#35	017-51204	017-51224	017-51244
#40	017-51205	017-51225	017-51245
#45	017-51206	017-51226	017-51246
#50	017-51207	017-51227	017-51247
#55	017-51208	017-51228	-
#60	017-51209	017-51229	-
#70	017-51210	-	-
#80	017-51211	-	-
#15-40	017-51212	017-51230	017-51248
#45-80	017-51213	017-51231	017-51249
#90-140	017-51214	017-51232	017-51250

- Radiopaque
- Cadmium-Free



Paper Points

Size	200/Slide Box	180/Cell Box
	REF	(5/Cell) REF
#15	017-51100	017-51120
#20	017-51101	017-51121
#25	017-51102	017-51122
#30	017-51103	017-51123
#35	017-51104	017-51124
#40	017-51105	017-51125
#45	017-51106	017-51126
#50	017-51107	017-51127
#55	017-51108	017-51128
#60	017-51109	017-51129
#70	017-51110	017-51130
#80	017-51111	017-51131
#15-40	017-51112	017-51132
#45-80	017-51113	017-51133
#90-140	017-51114	017-51134

- Super Absorbent
- ISO-Sized



Accessory Gutta Percha Points

	100/Box REF
XX-Fine	017-51260
X-Fine	017-51261
Fine	017-51262
Medium	017-51263
Coarse	017-51264
X-Coarse	017-51265
Assorted	017-51266



- Multi-Purpose

Accessory Paper Points

	200/Box REF	180/Cell Box (5/Cell)
XX-Fine	017-51140	017-51160
X-Fine	017-51141	017-51161
Fine	017-51142	017-51162
Medium	017-51143	017-51163
Coarse	017-51144	017-51164
X-Coarse	017-51145	017-51165
Assorted	017-51146	017-51166

Inject-R Fill® - Back Fill Injection System

- No repetitive additions of points or segments.
- No multiple injections.
- No disassembly of injection-system syringes for cleanup.
- No cutting of the carrier is necessary.



REF	Description
012-23018	Each package contains 6 Inject-R Fill cartridges

Tri-R Post System™

Each post is made from textured stainless steel with wide spiral grooves and wide flat spiral ridges for maximized balanced strength, retention and ability to follow the canal contour.

REF	Description
012-12400	Tri-R Post System™ 1 sterilizable organizer 24 color-coded posts in 4 sizes (6 each size)

Replacements

Size	Replacement Posts - 10/pack	Replacement Drills - 3/pack
1	012-12401	012-12501
2	012-12402	012-12502
3	012-12403	012-12503
4	012-12404	012-12504



Rotary Obturators

Rotary Obturators from Miltex are engine-driven nickel-titanium obturation files that feature a reverse-helix design to heat and condense gutta percha into an endodontically treated canal system. The Rotary Obturators are offered in a 23 mm operative length with a 0.02 taper and are available in ISO tip sizes 30 through 55.

FEATURES

ISO Tip & Taper
Nickel-Titanium
23 mm Operative Length
Reverse Helix Design

BENEFITS

Clearly marked for easy identification.
Provides flexibility in canal.
One size fits all.
Heats and condenses gutta percha into canal.

REF	Description - 6 per pack
012-19601	30/.02 mm Rotary Obturator
012-19602	35/.02 mm Rotary Obturator
012-19603	40/.02 mm Rotary Obturator
012-19604	45/.02 mm Rotary Obturator
012-19605	50/.02 mm Rotary Obturator
012-19606	55/.02 mm Rotary Obturator
012-19607	Assorted (1 file each size)
017-36309	Sprint TCM w/1:1 handpiece



Paste Carriers (Lentulo Type)

- Flexible, strong, spring-type stainless steel
- RA Instrument Driven
- Reverse-spiral shaped, fine wire

No.	Iso No. (Diameter of working part at tip end)	Root Canal Enlargement Up to:	RA 20 mm REF No.	RA 24 mm REF No.
1	25 (.25 mm)	35 mm	017-19510	017-19515
2	30 (.30 mm)	45 mm	017-19511	017-19516
3	35 (.35 mm)	60 mm	017-19512	017-19517
4	40 (.40 mm)	140 mm	017-19513	017-19518
1-4 Asst.*	-	-	017-19514	017-19519



Dr. Dovgan Condensers

Dovgan Endodontic Condensers are specifically designed for vertical condensation of gutta percha. These condensers feature a double-ended design that saves time during procedures and ISO sizes for easier identification.

Sizes 35 – 80 are available in a 23 mm version and a 27 mm extended length. Crafted from nickel titanium and machined to a .04 mm taper, the condensers ensure proper compacting of gutta percha around curved canals.

Sizes 100 – 140 are stainless steel with a GTX™ non-stick finish applied to the instrument. The GTX™ coating helps reduce the sticking and pull back effect gutta percha can have on condensers in the coronal region of the tooth.

Description	Tactile Tone™
Dovgan 35-45/04 NiTi	TFD3545N
Dovgan 35-45/04 NiTi X-Long	TFD3545NXL
Dovgan 60-80/04 NiTi	TFD6080N
Dovgan 60-80/04 NiTi X-Long	TFD6080NXL
Dovgan 100-140/02	TFD100140X

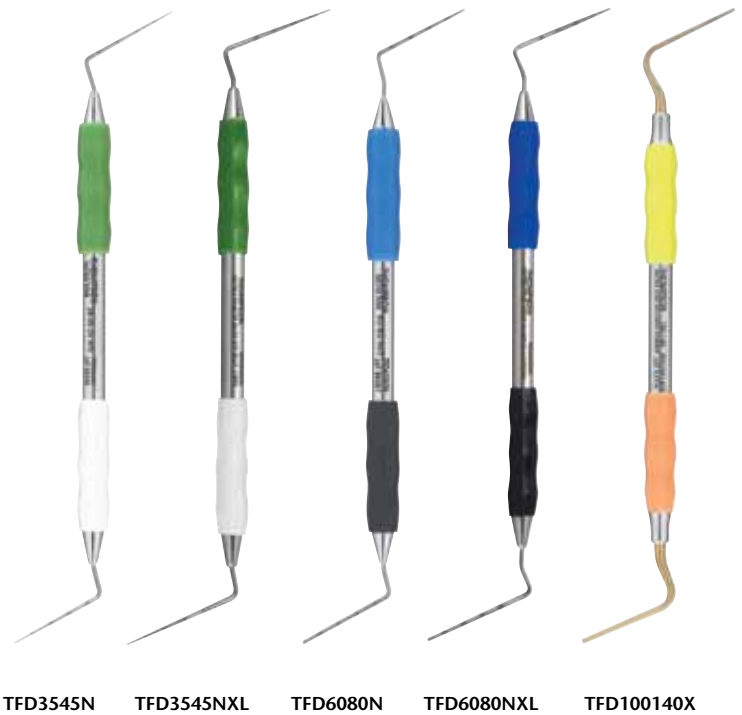

Endodontic Condensers/Pluggers

Endodontic condensers, also known as pluggers, are specifically designed for vertical condensation of gutta percha and other obturation materials. The condensers have 5 mm markings so clinicians can better gauge their working depth.

Description	Tactile Tone™	Round	Octagonal
Dr. Luks 1	UFL1	-	017-24630
Dr. Luks 2	UFL2	-	017-24631
Dr. Luks 3	UFL3	-	017-24632
Dr. Luks 4	UFL4	-	017-24633
ISO 100	UF100	-	-
ISO 110	UF110	-	-
ISO 130	UF130	-	-
ISO 30	UF30	-	-
ISO 35	UF35	-	-
ISO 40	UF40	-	-
ISO 45	UF45	-	-
ISO 50	UF50	-	-
ISO 55	UF55	-	-
ISO 60	UF60	-	-
ISO 65	UF65	-	-
ISO 70	UF70	-	-
ISO 80	UF80	-	-
ISO 85	UF85	-	-
ISO 90	UF90	-	-
Root Canal 1-3	TF13	017-24620	-
Root Canal 3 - 5	TF35	017-24621	-
Root Canal 5 - 7	TF57	017-24622	-
Root Canal 9 - 11	TF911	017-24623	-

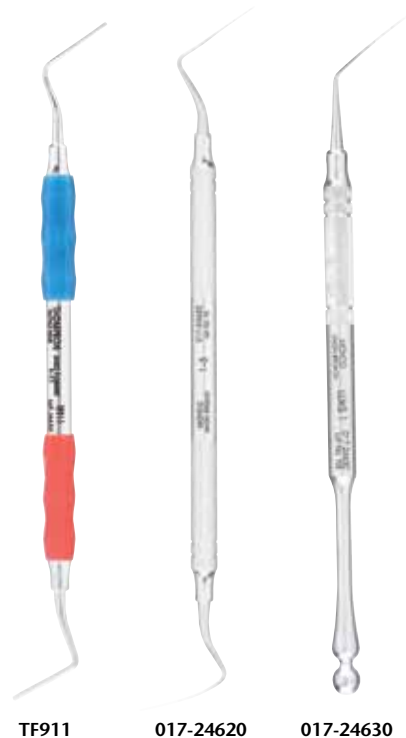

Finger Pluggers

Finger pluggers have a .02 mm taper and are designed with a flat tip for vertical condensation of gutta percha. The colored plastic handle of the finger pluggers identifies the ISO size and may be sterilized up to 390° F.

Stainless Steel - 6 per pack

Standardized Instrument Size	21 mm REF No.	25 mm REF No.
15	012-23010	012-23001
20	012-23011	012-23002
25	012-23012	012-23003
30	012-23013	012-23004
35	012-23014	012-23005
40	012-23015	012-23006
15-40*	012-23016	012-23007

* Assorted pack



Endodontic Spreaders - Single End

Endodontic Spreaders are specifically designed for lateral condensation of gutta percha and other obturation materials. Endodontic spreaders are available in stainless steel and nickel titanium.

Description	Tactile Tone™	Round	Octagonal
25S	-	-	017-24442
D-11	UED11	017-24440	-
D-11T	UED11T	017-24441	-
GP-2	UEGP2	-	-
GP-3	UEGP3	-	-
GP-3 NiTi	UEGP3N	-	-
ISO 25	UE25	-	-
ISO 25 NiTi	UE25NT	-	-
ISO 30	UE30	-	-
ISO 30 NiTi	UE30NT	- <td -	
ISO 35	UE35	-	-
ISO 40	UE40	-	-
ISO 40 NiTi	UE40NT	-	-
ISO 45	UE45	-	-
ISO 50	UE50	-	-
ISO 50 NiTi	UE50NT	-	-
ISO 55	UE55	-	-
ISO 60	UE60	-	-
ISO 60 NiTi	UE60NT	-	-
KR1*	-	-	017-24445
Ladmore 3 Long Tip	-	-	017-24480
W1S**	-	-	017-24450
W2S**	-	-	017-24451

* Designed by Drs. Kenneth Knopf and Paul A. Rosenberg

** Designed by Dr. Warren Wakai



UED11

017-24440

017-24445

Gutta Percha Heater Pluggers/Spreaders

REF	Instrument No.	Heater-Pluggers		Heater-Spreaders	
		D (1 mm)	D (16 mm)	D (5 mm)	D (16 mm)
017-24600	5	0.55	0.85	0.50	0.75
017-24601	7	0.70	1.00	0.50	0.75
017-24602	9	1.00	1.30	0.63	0.75
017-24603	11	1.20	1.50	0.63	0.75



017-24600

017-24601

017-24603

Finger Spreaders

Stainless steel finger spreaders are specially designed for lateral condensation of gutta percha and other obturation materials.

6 per pack

Standardized Instrument Size	21 mm REF No.	25 mm REF No.
XF	012-23160	012-23170
FF	012-23161	012-23171
MF	012-23162	012-23172
F	012-23163	012-23173
FM	012-23164	012-23174
MF	012-23165	012-23175
XF-M	012-23166	012-23176



Onyx-Flex™ - Nickel Titanium Finger Spreaders

Onyx-Flex™ nickel titanium finger spreaders are specially designed of nickel titanium to provide clinicians with flexibility and strength during lateral condensation of gutta percha and other obturation materials.

6 per pack

Standardized Instrument Size	25 mm REF No.
XF	012-14900
FF	012-14901
MF	012-14902
FF	012-14903
FM	012-14904
MF	012-14905
XF-M	012-14906



P.J. Luks Finger Spreaders

These stainless steel Finger Spreaders are specially designed for lateral condensation of gutta percha and other obturation materials.

Standardized Instrument Size	21 mm REF No.	25 mm REF No.
1	012-23033	012-23040
2	012-23034	012-23041
3	012-23035	012-23042
4	012-23036	012-23043
5	012-23037	012-23044
6	012-23038	012-23045
Assorted	012-23039	012-23046



Endodontic Forceps

REF	Description	Type	Length
6-338	WILLIAMS Splinter Forceps	straight	5-1/2" (14 cm)
6-340	WILLIAMS Splinter Forceps	45° angle	5-1/2" (14 cm)
6-342	WILLIAMS Splinter Forceps	right angle	4-3/4" (12.1 cm)
6-350	PEET Splinter Forceps	double curve	4-3/4" (12.1 cm)
7-20	HALSTED Mosquito Forceps	jaws angled 45° on flat, extra delicate	4-1/2" (11.4 cm)
66-660	Silver Point Holding Forceps	grooved jaws, right angle	-



6-338



6-340

6-342



6-350



7-20



66-660

Endo Block

The Endo Block is designed to accurately set stops for all endodontic files. The block is made from anodized aluminum and is autoclavable by any method. The 42 gauges allow precise placement of stops from 10 mm to 30 mm in .5 mm increments and can also be used to size gutta percha and paper points. The seven storage areas are ideal for storing files, gutta percha and paper points, while the endo ruler allows accurate out-of-tooth file measurements.



Part Number	Description
013-25600	Endo block, aluminum

Endo-Top II

Endo-Top II holds up to 36 finger instruments. It can be used in an upright position or placed on its side. The Endo-Top II is the perfect holder for narrow sterilizers.



Part Number	Description
017-48609	15 Hole
017-48634	36 Hole

Endo-Top III

Similar to the Endo-Top III, but larger for increased capacity (48 holes). Great for Rotary Instrument setups.

Part Number	Description
017-48628	48 hole

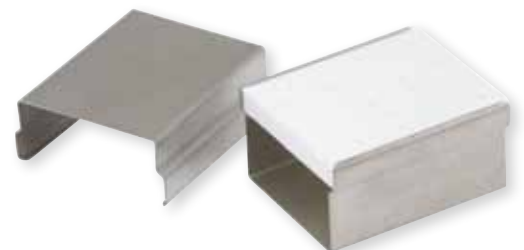

Gutta Box/Pulpa Box

Color coded aluminum organizer ideal for case-by-case set up. Sterilizable by dry heat or by autoclave.

Gutta Box for Gutta Percha and Paper Points		Pulpa Box File Holder	
Part Number	Description	Part Number	Description
017-48640	Silver	017-48650	Silver
017-48641	Blue	017-48651	Blue
017-48642	Red	017-48652	Red



Mini Endo

Anodized aluminum endo box holds up to 60 endodontic finger instruments. Color coded plastic cups hold absorbent points and gutta percha.

Part Number	Description
	13 x 5 x 4 cm
017-48600	Silver
017-48601	Blue
017-48602	Red



Endo Micro Pulpa

Small aluminum box holds up to 30 endodontic instruments.

Part Number	Description
	5 x 4 x 5 cm
017-48655	Endo Micro Pulpa - Silver
017-48656	Endo Micro Pulpa - Blue
017-48657	Endo Micro Pulpa - Red



Endodontic Mini-Stand

- Designed by Dr. Thomas P. Mullaney
- All aluminum
- Holds up to 27 finger instruments
- 8 slots for absorbent points
- Handy millimeter ruler on lid
- 3.25" x 1.25" x 2.25"



Part Number	Description
017-47150	Endodontic Mini-Stand

U-46 Finger Instrument Stand

- Millimeter Ruler
- All aluminum
- Holds up to 12 finger instruments
- 2.06" x 1" x 1.81"



Part Number	Description
017-47160	U-46 Finger Instrument Stands

University of Michigan Root Canal Cabinets

- All aluminum
- Style B U-97: 7 compartments - 3.5" x 1.25" x .5"
- Style C U-98: 13 compartments - 6.75" x 2.75" x .5"



Part Number	Description
017-47270	U of M Root Canal Cabinet - Style B
017-47275	U of M Root Canal Cabinet - Style C

U-63 Box for Absorbent Points

- Designed by Dr. Daniel Goodman
- All aluminum
- 3.5" x 3.5" x .5"
- May be used for silver points, gutta percha points, burs, etc.

Part Number	Description
017-47450	U-63 Box



U-62 Root Canal Instrument Organizer

- All aluminum
- Provides instant access to the correct-size endodontic instrument
- 36 compartments for storing packages of endodontic instruments
- Holds up to 432 packages
- An excellent inventory control aid
- 15.625" x 9.3125" x 2"

Part Number	Description
017-47510	U-62 Root Canal Organizer



Work-Utility Box

- Designed by Dr. Stanley Andrews
- Stainless steel
- Small and large sizes
- Watertight for use with germicide
- Small: 4" x 2" x 1.25"
- Large: 5.75" x 2.75" x 1.5"

Part Number	Description
017-4750	Work-Utility Box - Small
017-4751	Replacement Sponge
017-47575	Work-Utility Box - Large
017-47576	Replacement Sponge
U76L	Large
U76S	Small



U-68 Storage Box with 5 Compartments

- All aluminum
- 3.5" x 1.875" x .5"

Part Number	Description
017-47650	U-68 Storage Box

Scratch Brushes

- 2.875" long.
- Fine steel wire bound in plastic handle
- For cleaning endodontic instruments and burs
- May be trimmed when worn by prolonged use

Part Number	Description
017-23400	Scratch Brushes

Silicone Locator Stops

- Aids in establishing the canal depth and the working measurement of each file
- Sterilizable at temperatures up to 450 degrees Fahrenheit
- Clearly-defined shape permits alignment of stop with curve in instruments when instrumenting curved canals
- Easily slides on instruments
- Box of 100

Part Number	Description
017-25504	Red
017-25505	Gray

Endo Blocks

- Plastic Endo Blocks are designed to simulate a root canal
- They are ideal for product demonstrations and for practice with different files
- Box of 5

017-37101	Straight Endo Blocks
017-37100	Curved Endo Blocks

Finger & Thumb Rulers

	Finger Ruler	Thumb Ruler
Left	013-25711	013-25713
Right	013-25710	013-25712

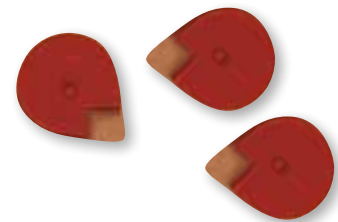

MILTEX® EAR INSTRUMENTS

Specialty Scissors.....	320
Alligator Ear Forceps	321
Ear Forceps.....	322-323
Ear Loops & Currettes.....	324-325
Picks, Knives, Chisels	326-327
Dressing & Tissue Forceps	328



Specialty Scissors

REF	Description	Type	Length
1700	Heavy Utility Scissors	straight, sharp/blunt	6-1/2" (16.5 cm)
1702	Heavy Utility Scissors	straight, blunt/blunt	6-1/2" (16.5 cm)
1704	Heavy Utility Scissors	curved, sharp/blunt	6-1/2" (16.5 cm)
1706	Heavy Utility Scissors	curved, blunt/blunt	6-1/2" (16.5 cm)



1700



1702



1704



1706

Microsurgery Alligator Ear Forceps and Scissors

Micro Alligator Ear Forceps are excellent for foreign body removal and ideal for precision grasping and extraction. Serrated and oval cup jaw patterns are available in sizes 0.5 mm to 0.8 mm wide in your choice of stainless or ebony finish. (see 19-2150-B)

REF	Description	Type	Shaft Length
19-2081	Micro Alligator Ear Forceps	serrated jaws, 0.6 mm wide	3 1/4" (8.3 cm)
19-2081-B	Micro Alligator Ear Forceps	serrated jaws, 0.6 mm wide, ebony finish	3 1/4" (8.3 cm)
19-2090	Micro Alligator Ear Forceps	oval cup jaws, 0.5 mm wide	3 1/4" (8.3 cm)
19-2090-B	Micro Alligator Ear Forceps	oval cup jaws, 0.5 mm wide, ebony finish	3 1/4" (8.3 cm)
19-2100	Micro Alligator Ear Forceps	serrated jaws, 0.8 mm wide	3 1/4" (8.3 cm)
19-2100-B	Micro Alligator Ear Forceps	serrated jaws, 0.8 mm wide, ebony finish	3 1/4" (8.3 cm)
19-2138	HOUSE Micro Strut Forceps	smooth jaws, 0.8 mm wide	2-3/4" (7.0 cm)
19-2110	Micro Alligator Ear Forceps	oval cup jaws, 0.8 mm wide	3 1/4" (8.3 cm)
19-2110-B	Micro Alligator Ear Forceps	oval cup jaws, 0.8 mm wide, ebony finish	3 1/4" (8.3 cm)
19-2150-B	BELLUCCI Micro Ear Scissors	4 mm blades, ebony finish	2-3/4" (7.0 cm)

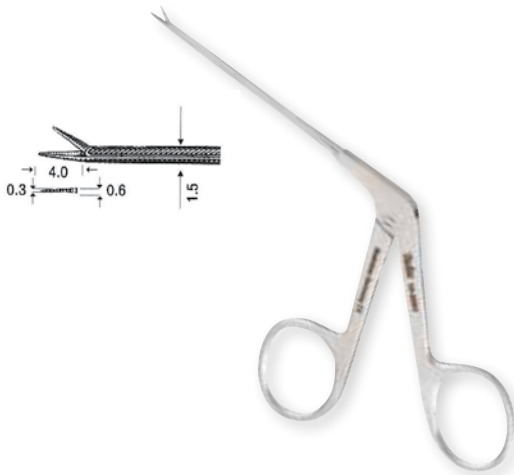

19-2081
19-2081-B

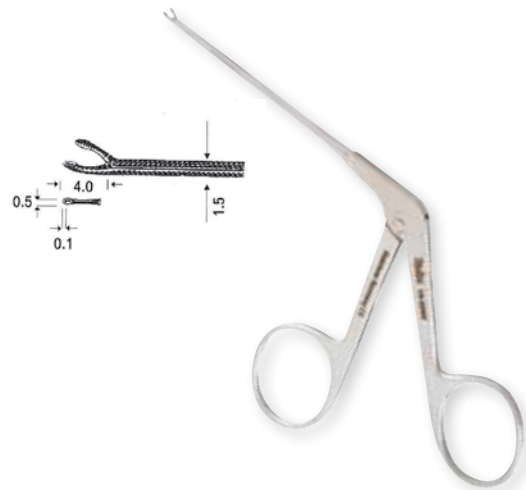

19-2090
19-2090-B

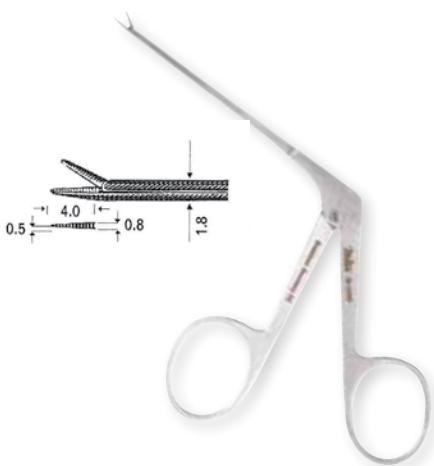

19-2100
19-2100-B
19-2138

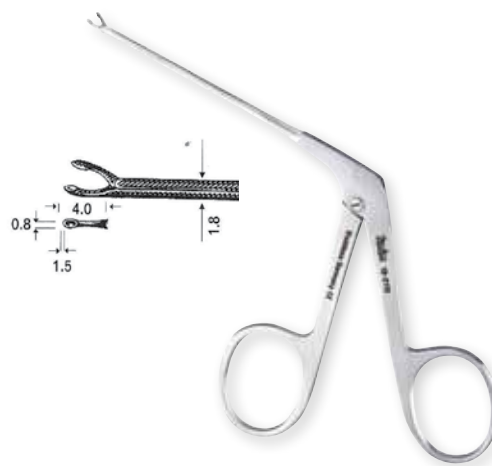

19-2110
19-2110-B



19-2150-B

Ear Forceps

REF	Description	Type	Length
19-404	NOYES Alligator Forceps	spring handle	4" (10.2 cm)
19-434	HARTMAN-NOYES Alligator Ear Forceps	serrated jaws	3-1/4" (8.3 cm) shaft
19-437	WEINGARTNER Alligator Ear Forceps	concave, serrated jaws	3" (7.6 cm) shaft
19-438	STRUEMPEL Alligator Ear Forceps	fenestrated, oval spoon jaws	3" (7.6 cm) shaft
19-439	Duckbill Ear Alligator Forceps	very flat, serrated jaws, rounded tip	3" (7.6 cm) shaft
19-442	HOFFMAN Alligator Ear Forceps	through cutting round jaws	3" (7.6 cm) shaft

*tips enlarged to show detail



19-434



19-437



19-438



19-439



19-442

Ear Forceps & Scissors

REF	Description	Type	Shaft Length
19-415	HOUSE Miniature Forceps	finely serrated jaws 4 mm, extra delicate	2-7/8" (7.3 cm)
19-416	GREVEN Ear Forceps	5 mm jaws with 2.5 mm tips serrated and touching	2-7/8" (7.3 cm)
19-417	MILTEX Ear Forceps	0.9 mm x 2 mm cups, extra fine	2-27/32" (7.2 cm)
19-418	MILTEX Ear Forceps	0.75 mm cups	2-51/64" (7.1 cm)
19-420	HOUSE Miniature Ear Forceps	0.6 mm x 1 mm cups, straight	2-7/8" (7.3 cm)
19-421	HOUSE Miniature Ear Forceps	0.6 mm x 1 mm cups, angled left 15 degrees	2-27/32" (7.2 cm)
19-422	HOUSE Miniature Ear Forceps	0.6 mm x 1 mm cups, angled right 15 degrees	2-27/32" (7.2 cm)
19-480	MCGEE Crimper/Wire Closure Forceps	short 3 mm jaws angled slightly downward	2-27/32" (7.2 cm)
19-481	HOUSE-DIETERS Malleus Nipper	2 mm jaws	2-61/64" (7.5 cm)
19-2114	HOUSE Alligator and Crimper Forceps	very flat 8 mm serrated tapered jaws, dull point	2-7/8" (7.3 cm)
19-2115	BELLUCCI Ear Forceps	serrated jaws 8 mm	2-61/64" (7.5 cm)
19-2116	GOODHILL Ear Forceps	serrated jaws 5 mm	3" (7.6 cm)
19-2117	HOUSE Forceps	serrated jaws 6 mm, side opening to right	2-7/8" (7.3 cm)
19-2118	HOUSE Oval Cup Forceps	0.9 mm cups, angled right 15 degrees	2-51/64" (7.1 cm)
19-2119	HOUSE Oval Cup Forceps	0.9 mm cups, angled left 15 degrees	2-51/64" (7.1 cm)
19-2155	BELLUCCI Scissors	7 mm blades, curved left	2-61/64" (7.5 cm)
19-2156	BELLUCCI Scissors	7 mm blades, curved right	2-61/64" (7.5 cm)
19-2157	HOUSE-BELLUCCI Alligator Scissors	5 mm blades, straight	2-29/32" (7.4 cm)
19-2158	HOUSE-BELLUCCI Alligator Scissors	5 mm blades, curved left	2-29/32" (7.4 cm)
19-2159	HOUSE-BELLUCCI Alligator Scissors	5 mm blades, curved right	2-29/32" (7.4 cm)
19-2160	BELLUCCI Scissors	7 mm blades, straight	3-1/32" (7.7 cm)

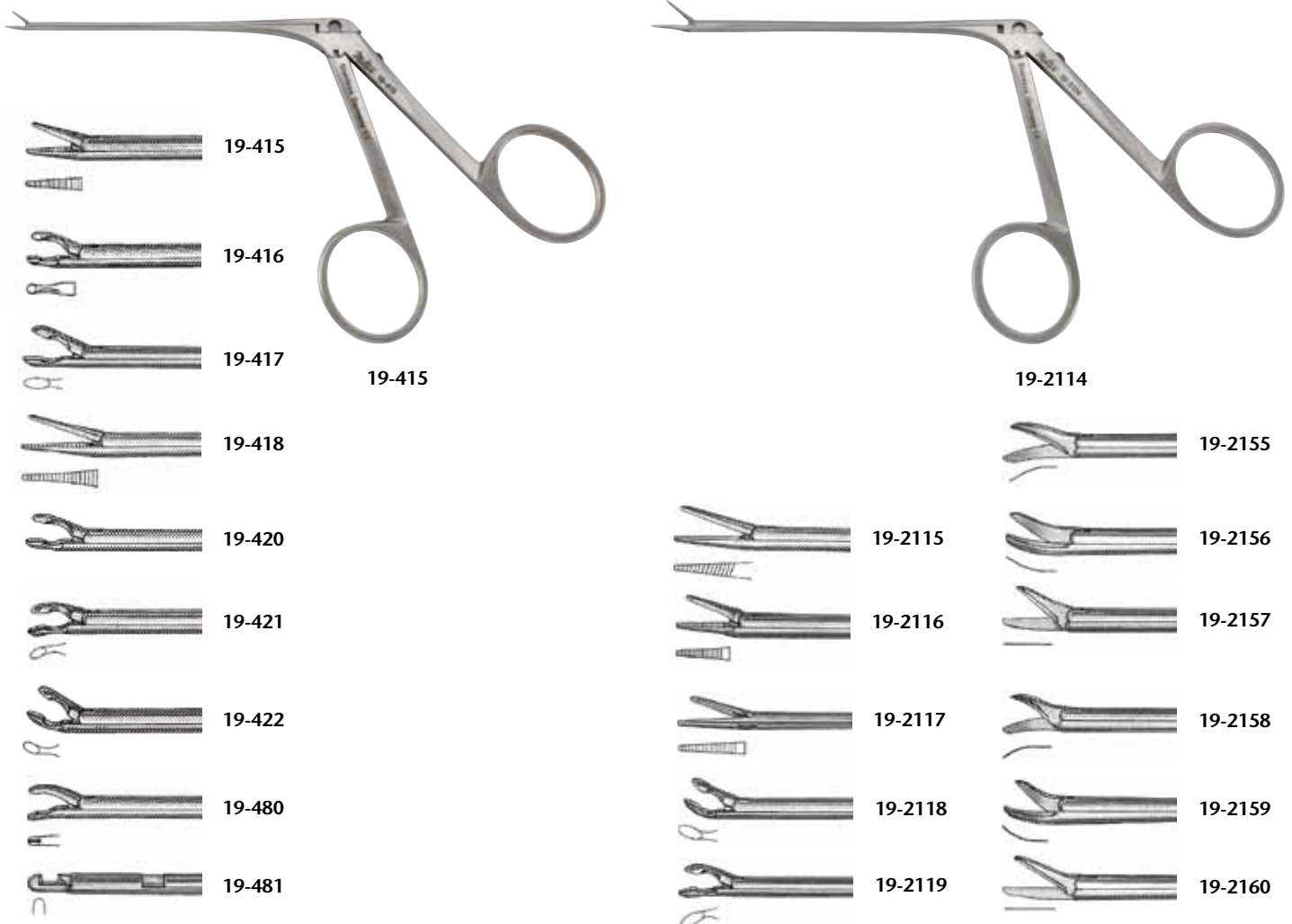

Ear Loops & Curettes

REF	Description	Type	Length
19-314	BILLEAU Flexible Ear Loop	small size no. 1	6-1/2" (16.5 cm)
19-316	BILLEAU Flexible Ear Loop	medium size no. 2	6-1/2" (16.5 cm)
19-318	BILLEAU Flexible Ear Loop	large size no. 3	6-1/2" (16.5 cm)
19-260	BUCK Ear Curette	straight, sharp, size 00	6-1/2" (16.5 cm)
19-262	BUCK Ear Curette	straight, sharp, size 0	6-1/2" (16.5 cm)
19-264	BUCK Ear Curette	straight, sharp, size 1	6-1/2" (16.5 cm)
19-266	BUCK Ear Curette	straight, sharp, size 2	6-1/2" (16.5 cm)
19-268	BUCK Ear Curette	straight, sharp, size 3	6-1/2" (16.5 cm)
19-270	BUCK Ear Curette	angled, sharp, size 00	6-1/2" (16.5 cm)
19-272	BUCK Ear Curette	angled, sharp, size 0	6-1/2" (16.5 cm)
19-274	BUCK Ear Curette	angled, sharp, size 1	6-1/2" (16.5 cm)
19-276	BUCK Ear Curette	angled, sharp, size 2	6-1/2" (16.5 cm)
19-278	BUCK Ear Curette	angled, sharp, size 3	6-1/2" (16.5 cm)
19-280	BUCK Ear Curette	straight, blunt, size 00	6-1/2" (16.5 cm)
19-282	BUCK Ear Curette	straight, blunt, size 0	6-1/2" (16.5 cm)
19-284	BUCK Ear Curette	straight, blunt, size 1	6-1/2" (16.5 cm)
19-286	BUCK Ear Curette	straight, blunt, size 2	6-1/2" (16.5 cm)
19-288	BUCK Ear Curette	straight, blunt, size 3	6-1/2" (16.5 cm)
19-290	BUCK Ear Curette	angled, blunt, size 00	6-1/2" (16.5 cm)
19-292	BUCK Ear Curette	angled, blunt, size 0	6-1/2" (16.5 cm)
19-294	BUCK Ear Curette	angled, blunt, size 1	6-1/2" (16.5 cm)
19-296	BUCK Ear Curette	angled, blunt, size 2	6-1/2" (16.5 cm)
19-298	BUCK Ear Curette	angled, blunt, size 3	6-1/2" (16.5 cm)
19-320	MILTEX Disposable Ear Curette	ring tip, quantity 50/box	-
19-321	MILTEX Disposable Ear Curette	loop tip, quantity 50/box	-
19-322	MILTEX Disposable Ear Curette	small spoon tip, quantity 50/box	-
19-323	MILTEX Disposable Ear Curette	large spoon tip, quantity 50/box	-

*tip images enlarged to show detail



19-314 to
19-318

19-260 to
19-298

19-320

19-321

19-322

19-323

Ear Curettes

REF	Description	Type	Length
19-505	ROSEN Knife Curette	small 2 mm diameter blade, angled up 45 degrees, octagonal handle	6-39/64" (16.8 cm)
19-506	ROSEN Knife Curette	large 2.5 mm diameter blade, angled up 45 degrees, octagonal handle	6-39/64" (16.8 cm)
19-2504	HOUSE-Sheehy Knife Curette	2 mm diameter semi-sharp blade, malleable shaft, octagonal handle, referred to as "small weapon"	6-39/64" (16.8 cm)
19-2528	HOUSE Curette	light angle, 2 mm and 2.5 mm oval cup, double-ended, flat handle	7" (17.8 cm)
19-2529	HOUSE Curette	strong angle, 2.25 mm x 3 mm and 2 mm x 2.5 mm cups, double-ended, flat handle	7" (17.8 cm)
19-2530	HOUSE Stapes Curette	strong angle, 2.25 mm x 3 mm and 2 mm x 2.5 mm cups, double-ended, flat handle	6" (15.2 cm)

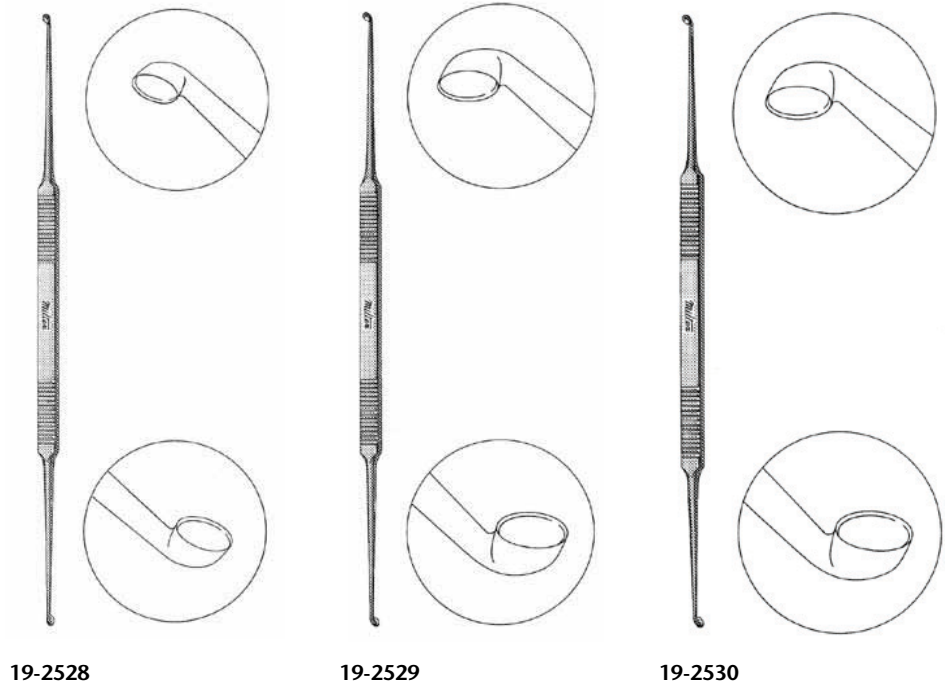
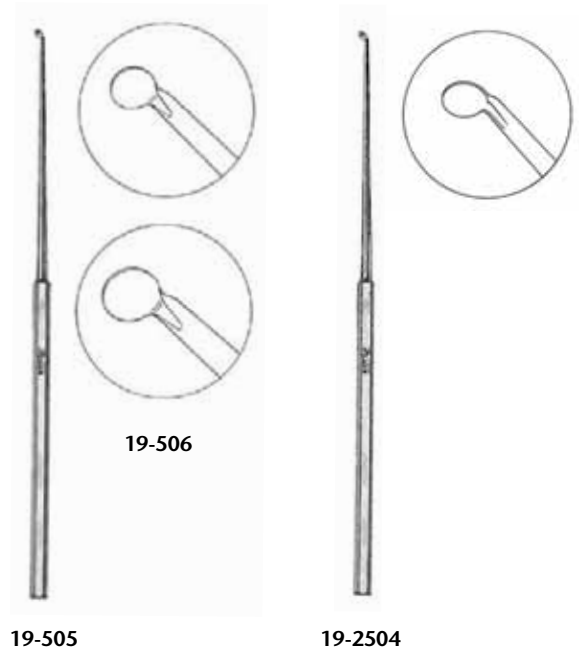

Picks

REF	Description	Type	Length
19-211	ROSEN Pick	curved 3 mm from tip	6-1/8" (15.6 cm)
19-212	ROSEN Pick	curved 1.5 mm from tip	6-1/8" (15.6 cm)
19-2505	HOUSE Strut Caliper	5 mm mark from tip, malleable shaft, octagonal handle	6-39/64" (16.8 cm)
19-2510	HOUSE Barbara Pick	straight point, malleable shaft, octagonal handle	6-1/4" (15.9 cm)
19-2511	HOUSE Obtuse Pick	0.25 mm long point angled 30°, malleable shaft, octagonal handle	6-19/64" (16 cm)
19-2512	HOUSE Oval Window Pick	0.33 mm long point angled 30°, malleable shaft, octagonal handle	6-39/64" (16.8 cm)
19-2513	HOUSE Oval Window Pick	0.66 mm long point angled 30°, malleable shaft, octagonal handle	6-39/64" (16.8 cm)
19-2514	HOUSE Oval Window Pick	0.33 mm long point angled 90°, malleable fine shaft, octagonal handle	6-39/64" (16.8 cm)
19-2515	HOUSE Strut Pick	0.5 mm long point angled 90°, malleable medium shaft, octagonal handle	6-39/64" (16.8 cm)
19-2516	HOUSE Oval Window Pick	0.33 mm long point angled 90°, malleable medium shaft, octagonal handle	6-39/64" (16.8 cm)
19-2517	HOUSE Strut Pick	0.66 mm long point angled 90°, medium shaft, octagonal handle	6-39/64" (16.8 cm)

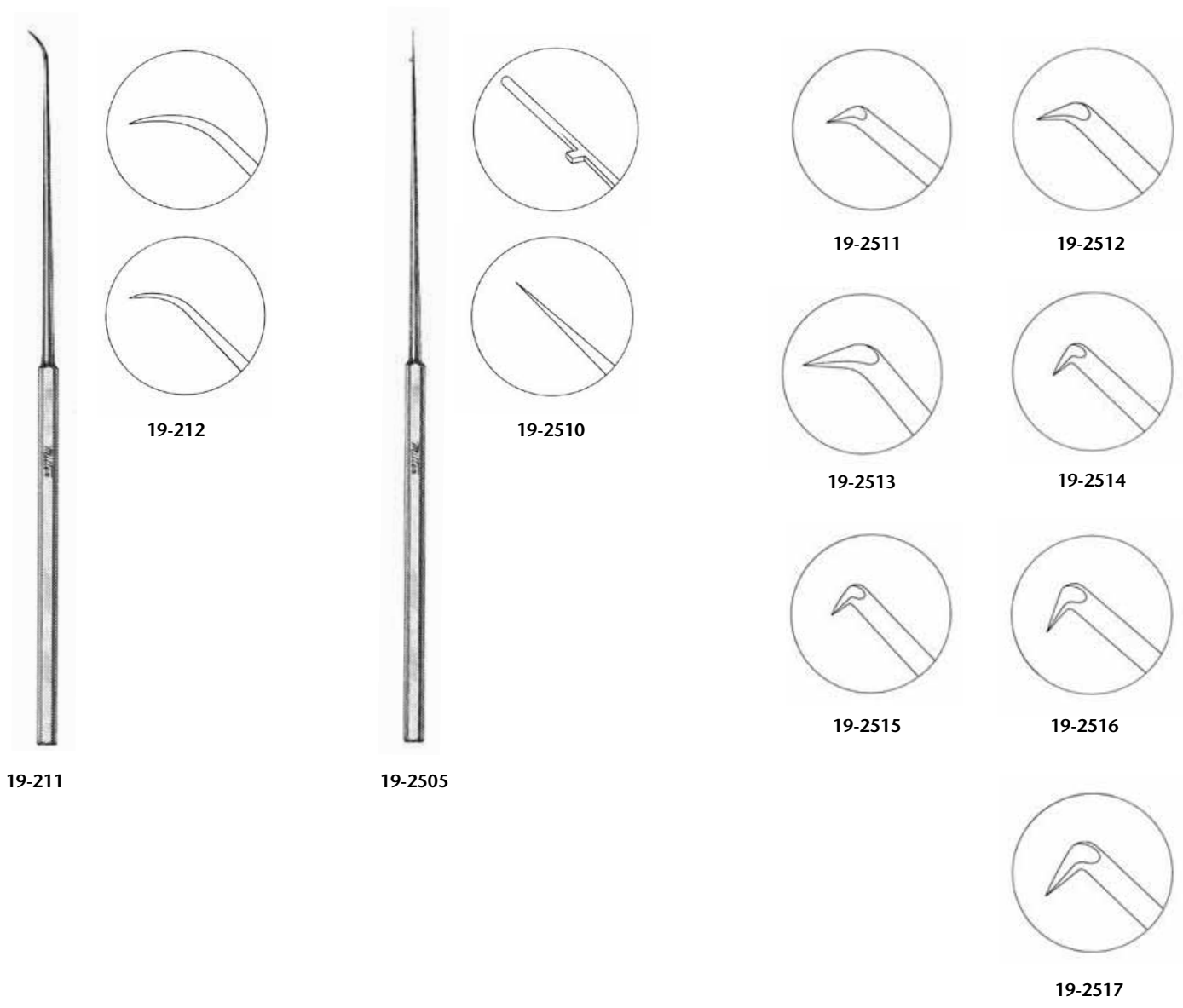

Needles and Hooks

REF	Description	Type	Length
19-2500	HOUSE Needle	curved tip, semi-sharp point, malleable shaft, octagonal handle	6-39/64" (16.8 cm)
19-2501	HOUSE Needle	ROSEN type curved and slightly dulled tip, malleable shaft, octagonal handle	6-39/64" (16.8 cm)
19-2502	HOUSE Hook	1 mm long tip, angled left 90°, malleable shaft angled 8°, octagonal handle	6-1/8" (15.6 cm)
19-2503	HOUSE Hook	1 mm long tip, angled right 90°, malleable shaft angled 8°, octagonal handle	6-1/8" (15.6 cm)



19-2500



19-2501

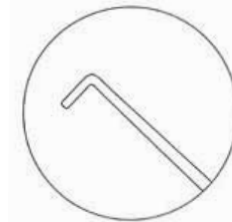

19-2502

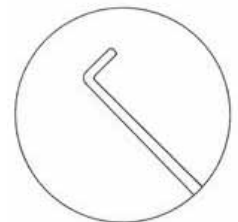

19-2503

Knives, Elevators and Chisels

REF	Description	Type	Length
19-2522	HOUSE Tympanoplasty Knife	7 mm curved blade, octagonal handle	6-39/64" (16.8 cm)
19-2523	HOUSE Lancet Knife	2 mm x 3 mm tapered tip angled 45°, octagonal handle, referred to as "Number Two Knife"	6-39/64" (16.8 cm)
19-2524	HOUSE Incudostapedial Joint Knife	0.5 mm wide x 1.5 mm long, blade angled 20°, octagonal handle	6-39/64" (16.8 cm)
19-2525	HOUSE Incudostapedial Joint Knife	0.75 mm diameter blade angled 60°, octagonal handle	6-39/64" (16.8 cm)
19-2526	HOUSE Sickle Knife	0.75 mm curved blade, octagonal handle, referred to as "Number One Knife"	6" (15.2 cm)
19-2527	HOUSE Myringotomy Knife	3.5 mm blade, octagonal handle	6" (15.2 cm)
19-2518	HOUSE Elevator	1 mm wide x 12 mm long tip angled 15°, octagonal handle, referred to as "The Gimmick"	6-39/64" (16.8 cm)
19-2520	HOUSE Elevator & Chisel	1 mm wide curved scraping tip, 88 mm working length, flat bayonet handle	6-11/16" (17 cm)



19-2522



19-2523



19-2524



19-2525

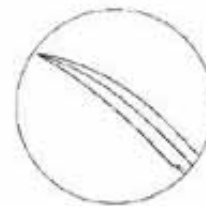

19-2526



19-2527

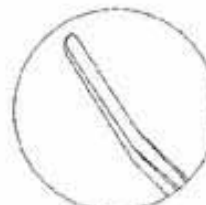

19-2518

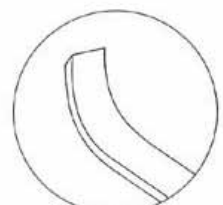

19-2520

Forceps

REF	Description	Type	Length
6-197	GRUENWALD (JANSEN) Bayonet Dressing Forceps	serrated	6-1/2" (16.5 cm)
6-198	ADSON Bayonet Dressing Forceps	serrated	8-1/4" (21 cm)
19-350	WILDE Ear Forceps	angular with serrated tips	5" (12.7 cm)
19-356	WILDE Ear Forceps	cross-action, angular with serrated tips	4-3/4" (12.1 cm)
19-360	BLAKE Ear Forceps	very delicate, angular with serrated tips	4-1/8" (10.5 cm)
19-370	LUCAE Ear Forceps	bayonet shape, serrated tips	5-1/2" (14 cm)
19-371	JANSEN Ear Forceps	bayonet shape, very delicate with 2 mm wide serrated tips	6-1/4" (15.9 cm)



6-197

6-198

19-350
19-356

19-360

19-370

19-371

MILTEX® ELECTROSURGERY INSTRUMENTS

Schroeder-Braun Tenaculum Forceps	330
Dressing and Tissue Forceps	331
Sterile Disposable Electrodes.....	332

Electrosurgical Instruments

REF	Description	Type	Length
31-1351	MILTEX-KOGAN	narrow tip (3.2 mm x 25 mm) grip-lock ratchet and gauge	10-3/4" (27.3 cm)
31-1352	MILTEX-KOGAN	regular tip (7.2 mm x 25 mm) grip-lock ratchet and gauge	10-3/4" (27.3 cm)
31-1353	KOGAN	narrow tip (3.2 mm x 25 mm)	10-3/4" (27.3 cm)
31-1354	KOGAN	regular tip (7.2 mm x 25 mm)	10-3/4" (27.3 cm)
31-965	SCHROEDER-BRAUN Tenaculum Forceps	straight, coated tips	9-3/4" (24.8 cm)
31-70	Redundant Wall Retractor	medium 22 mm x 57 mm blade	7-3/4" (19.5 cm)
31-71	Redundant Wall Retractor	large 22 mm x 75 mm blade	7-3/4" (19.5 cm)
31-1355	Lateral Retractor	extra long thumb ratchet, 22 mm x 57 mm blade	8-1/4" (21cm)

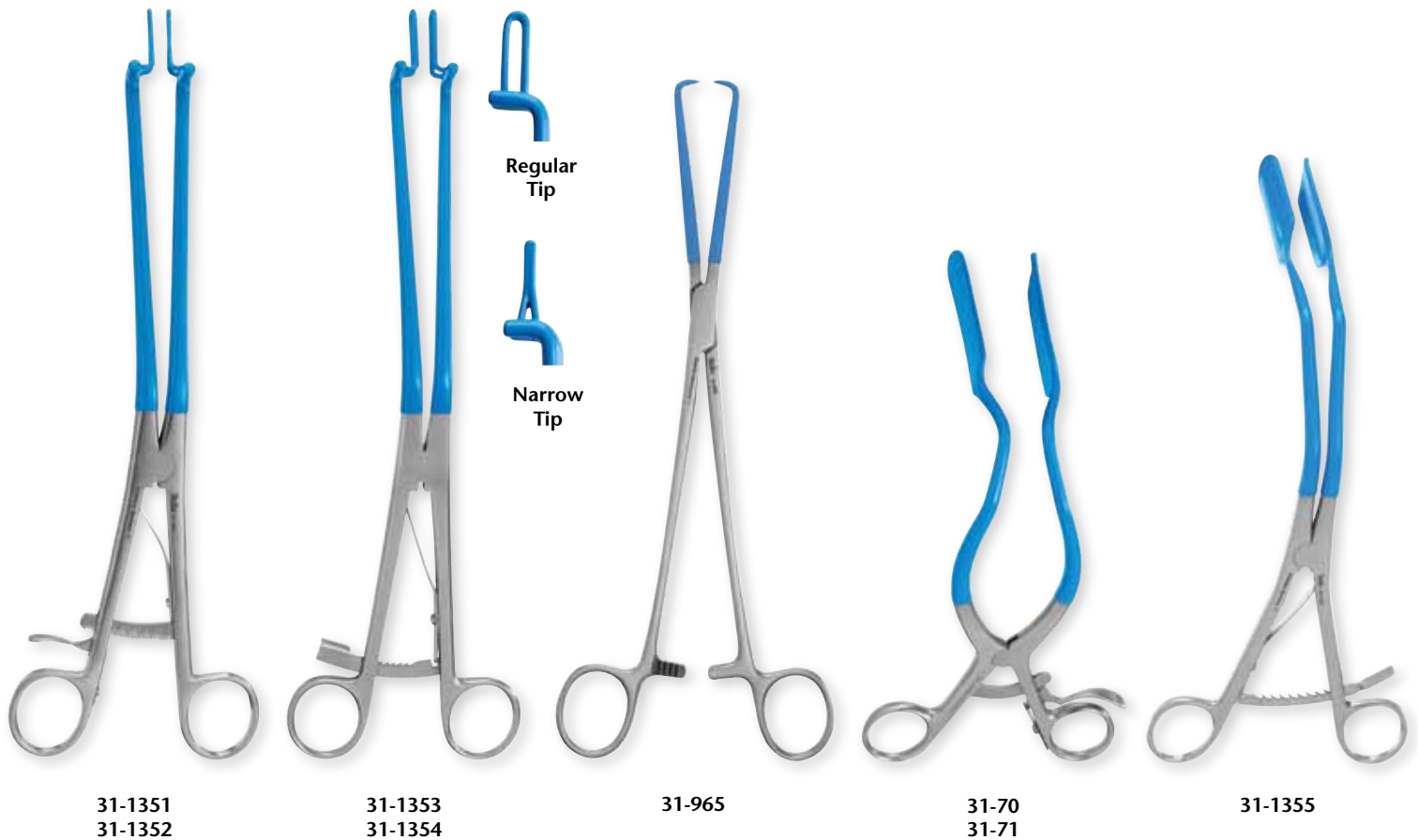

Dressing & Tissue Forceps

Tissue forceps have 1 x 2 teeth to grasp and hold tissue for removal and are available with or without coated tips.

REF	Description	Type	Length
31-14	Dressing Forceps	serrated with coated tips	8" (20.3 cm)
31-16	Dressing Forceps	serrated with coated tips	10" (25.4 cm)
31-48	Tissue Forceps	1x2 teeth with exposed tips	8" (20.3 cm)
31-49	Tissue Forceps	1x2 teeth with coated tips	8" (20.3 cm)
31-50	Tissue Forceps	1x2 teeth with exposed tips	10" (25.4 cm)
31-51	Tissue Forceps	1x2 teeth with coated tips	10" (25.4 cm)

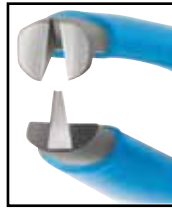

31-14
31-16



31-48
31-50

Iris Hook & EMMETT Tenaculum Hooks

The Iris Hook is used for holding tissue during excision. It is smaller than the Emmett Hook and is slightly angled.

The Emmett Tenaculum Hook has a sharp point for use during excision and is available in 4 different styles. All tips are exposed for better tissue grasping.

REF	Description	Type	Length
31-949	Iris Hook	small, delicate 4 mm hook, with exposed tip	10" (25.4 cm)
31-951	EMMETT Tenaculum Hook	Style 1, half curved, small	9" (22.9 cm)
31-952	EMMETT Tenaculum Hook	Style 2, acute angle	9" (22.9 cm)
31-953	EMMETT Tenaculum Hook	Style 3, right angle	9" (22.9 cm)
31-954	EMMETT Tenaculum Hook	Style 4, half-curved, large	9" (22.9 cm)



31-949



31-951 to
31-954



Style 1
31-951



Style 2
31-952



Style 3
31-953



Style 4
31-954

Sterile Disposable Electrodes

- Loop and Square working ends are manufactured with Tungsten Wire to maintain shape throughout procedure
- Sterile 5-year shelf life
- 5.1" (13 cm) shaft
- 3/32" (2.4 mm) stainless steel connector shaft fits most standard electrosurgical pencils and generators
- Each electrode is sterilized & individually packaged
- Disposable, single-use, Boxes of 5

REF	Description	Size
31-5000	Ball	(3 mm diameter)
31-5002	Ball	(5 mm diameter)
31-5022	Square	(10 mm width x 8 mm depth)
31-5054	Loop	(10 mm width x 8 mm depth)
31-5056	Loop	(10 mm width x 10 mm depth)
31-5070	Loop	(15 mm width x 5 mm depth)
31-5072	Loop	(15 mm width x 8 mm depth)
31-5074	Loop	(15 mm width x 10 mm depth)
31-5090	Loop	(20 mm width x 8 mm depth)
31-5092	Loop	(20 mm width x 10 mm depth)
31-5094	Loop	(20 mm width x 12 mm depth)
31-5096	Loop	(20 mm width x 15 mm depth)
31-5098	Loop	(20 mm width x 20 mm depth)

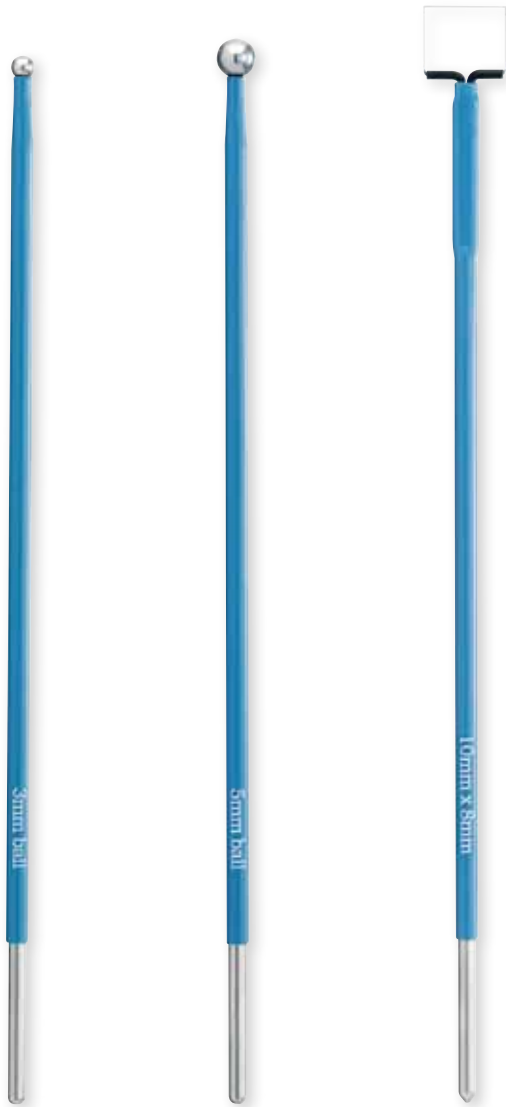

31-5000

31-5002

31-5022



31-5054

31-5056

31-5070

31-5072



31-5074

31-5090

31-5092

31-5094



31-5096

31-5098

MILTEX® SURGICAL & DENTAL KITS

Canine and Feline Spay Kit.....	334
General Surgery Kit.....	335
Orthopedic Kit.....	336
Osteotome Kit	336
Basic Eye Kit	337
Microsurgical Kit.....	337
Niemiec Extraction Kit.....	338
Winged Elevator Kit.....	339
Luxating Elevator Kit.....	340
Periotome Kit.....	335
CryoSolutions	341
Weldin Periodontal Kit.....	342

Canine & Feline Spay Kit



6810
6820

CANINE REF# 6810 FELINE REF# 6820

Set includes:

Qty.	REF	Description	Length	
1	4-7	#3 Scalpel Handle	-	(1)
1	5-124	MAYO Scissors	6-3/4" (17.1 cm) straight	(2)
1	6008	SNOOK Ovariectomy Hook	-	(3)
2	7-38	KELLY Hemostat	5-1/2" (14 cm) curved	(4)
1	5-182	METZENBAUM Scissors	7" (17.8 cm) curved	(5)
1	6-44	Tissue Forceps	5-1/2" (14 cm) 1x2 teeth	(6)
1	16-6	ALLIS Tissue Forceps	6" (15.2 cm) 4x5 teeth	(7)
4	7-504	BACKHAUS Towel Clamps	3-1/2" (8.9 cm)	(8)
1	6-124	BROWN-ADSON Forceps	4-3/4" (12.1 cm) 7x7 teeth	(9)
1	8-16TC or 8-15TC	OLSEN-HEGAR Needle Holder	6-1/2" (16.5 cm) (canine)	(10)
		OLSEN-HEGAR Needle Holder	5-1/2" (14 cm) (feline)	
2	7-4	HALSTED Mosquito Forceps	5" (12.7 cm) curved	(11)
2	7-172	ROCHESTER-CARMALT Forceps	6-1/4" (15.9 cm) curved	(12)
1	3-6815	Storage Cassette	15" x 8-1/4" x 1-1/4"	(13)



Canine Spay Kit pictured

General Surgery Kit

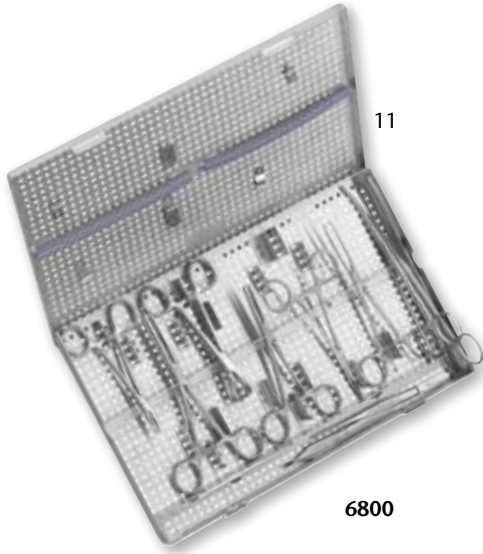

REF# 6800 General Surgery Kit Includes

Qty.	REF	Description	Length	
1	5-124	MAYO Scissors	6-3/4" (17.1 cm) straight	(1)
1	4-7	#3 Scalpel Handle	-	(2)
1	6008	SNOOK Ovariectomy Hook	-	(3)
3	7-4	HALSTED Mosquito Forceps	5" (12.7 cm) curved	(4)
2	7-36	KELLY Forceps	5-1/2" (14 cm) straight	(5)
1	5-182	METZENBAUM Scissors	7" (17.8 cm) curved	(6)
1	6-124	BROWN-ADSON Forceps	4-3/4" (12.1 cm) 7x7 teeth	(7)
4	7-172	ROCHESTER-CARMALT Forceps	6-1/4" (15.9 cm) curved	(8)
4	7-506	BACKHAUS Towel Clamps	5-1/4" (13.3 cm)	(9)
1	8-15TC	OLSEN-HEGAR Needle Holder	5-1/2" (14 cm)	(10)
1	3-6815	Storage Cassette	15" x 8-1/4" x 1-1/4"	(11)



Periotome Kit

Periotomes are designed for separating the periodontal ligament fibers from the tooth in preparation for a dental extraction.

Periotomes are available in three double-ended styles: straight blade, hatchet-blade and hoe-blade patterns, giving the user a wide variety of blade options. All instruments feature a lightweight size 6 stainless steel handle.

REF	Description
70-177	Periotome Kit Includes 1 each of:
70-170	Periotome Straight Double Ended
70-171	Periotome Hatchet Double Ended
70-172	Periotome Hoe Double Ended
3-072007	MILTEX Slimline Storage Cassette 7" L x 2-5/8" W x 11/16" H



Orthopedic Kit

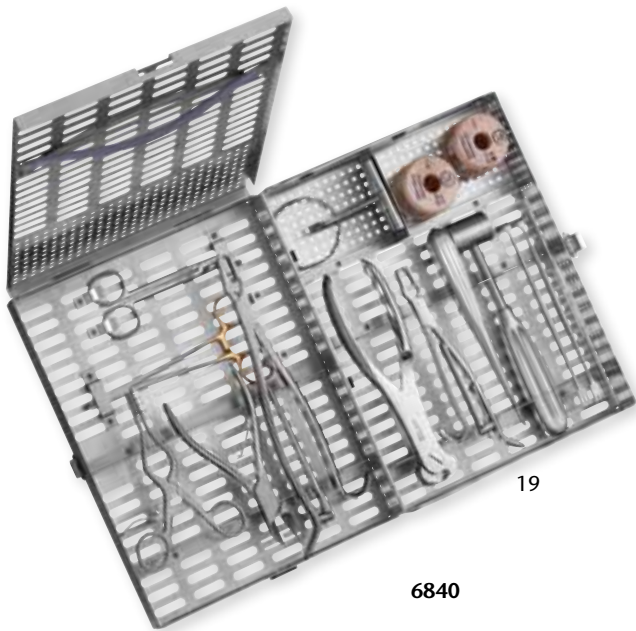

6840

REF# 6840 Orthopedic Kit Includes:

Qty.	REF	Description	
1	9-40-20	Suture Wire, 20 gauge	(1)
1	9-40-30	Suture Wire, 30 gauge	(2)
1	9-124	Wire Cutter	(3)
1	11-74	SENN Retractor, sharp	(4)
1	11-76	SENN Retractor, blunt	(5)
1	11-608	WEITLANER Retractor	(6)
1	18-1968	FREER Elevator	(7)
1	19-708	SPRATT Bone Curette	(8)
1	19-792	LUCAE Mallet	(9)
1	21-369	FOMAN Rasp	(10)
1	22-500TC	Wire Twister	(11)
2	26-120	GIGLI-STRULY Saw Handle	(12)
1	26-130	GIGLI-STRULY Saw	(13)
1	27-4	KERN Bone Holding Forceps, large	(14)
1	27-7	KERN Bone Holding Forceps, small	(15)
1	27-158	Pin Cutter	(16)
1	27-1390	LISTON Bone Cutting Forceps	(17)
1	27-603	Swiss Pattern Osteotomes	(18)
1	3-6845	Storage Cassette, 10-3/4" x 8-1/4" x 2-3/4"	(19)



Osteotome Kit

- 2 mm
- 4 mm
- 6 mm
- 8 mm
- 10 mm
- 12 mm
- 14 mm
- 18 mm
- 20 mm



REF# 27-610 Osteotome Kit includes:

Set of 9 SWISS Pattern
Osteotomes 2 mm to 20 mm
complete in customized
storage cassette (10-1/2" x 8" x 1/2")

27-610

Basic Veterinary Eye Kit

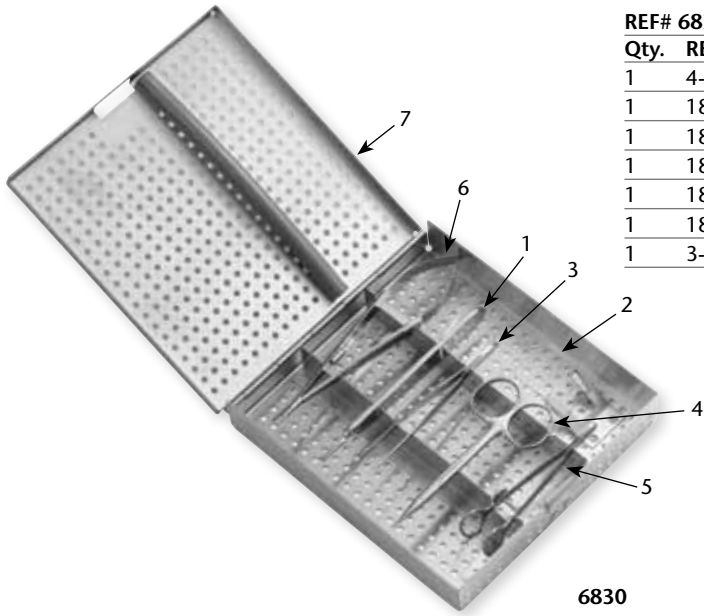

REF# 6830 Basic Veterinary Eye Kit includes:

Qty.	REF	Description	Length
1	4-7	#3 Scalpel Handle	- (1)
1	18-35	BARRAQUER Wire Eye Speculum	- (2)
1	18-780	Eye Dressing Forceps	4" (10.2 cm) (3)
1	18-1462	STEVENS Tenotomy Scissors	4-1/8" (10.5 cm) straight (4)
1	18-1202	DESMARRES-CHALAZION Forceps	3-1/2" (8.9 cm) (5)
1	18-1828	CASTROVIEJO Needle Holder	5-1/2" (14 cm) straight (6)
1	3-6835	Storage Cassette	6-1/2" x 6-1/4" x 1-1/4" (7)

Microsurgical Instrument Kit

REF# 6890 *with MILTEX Storage Cassette & Mat

MILTEX® Microsurgical Kit Includes 1 each of:

REF	Description	Type	Length
8-4	DERF Needle Holder	serrated jaws, 4000 teeth per square inch	4-3/4" (12.1cm) (1)
5-300	Iris Scissors	straight	4" (10.2 cm) (2)
17-305X	SWISS Jeweler Style Forceps	non-magnetic stainless steel, style 5, micro-fine	4-3/8" (11.2 cm) (3)
18-948	McPHERSON Micro Iris Suturing Forceps	straight, smooth platform 0.3 mm X 5 mm, no teeth	3-1/2" (8.9 cm) (4)
18-1625	McPHERSON-VANNAS Micro Iris Scissors	straight, sharp points	3-1/4" (8.3 cm) (5)
18-34	Plain Wire Speculum	blades 15 mm wide	2-1/2" (6.4 cm) (6)
10-2-ST	MILTEX Probe	double ended, malleable, sterling	4-1/2" (11.4 cm) (7)
4-6835	MILTEX Storage Cassette	dimensions 6-1/2" x 6-1/4" x 1-1/4"	- (8)
4-6835MAT	MILTEX Storage Cassette Mat	-	- (9)
REF 6890-NC	*without MILTEX Storage Cassette & Mat	-	- (10)

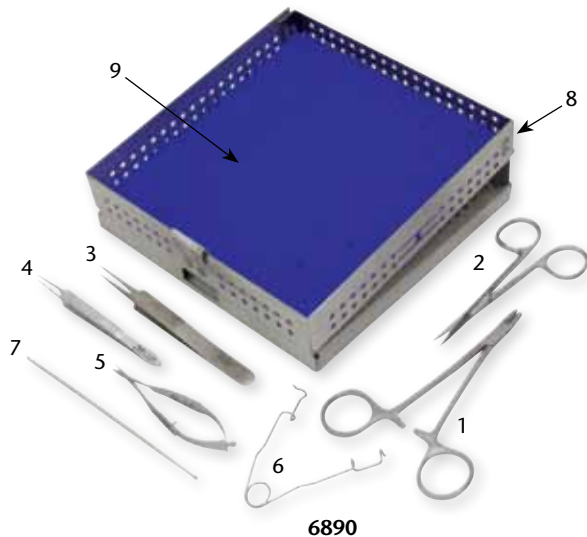

Miltex® Niemic Veterinary Extraction Instrument Kit

Designed and approved by Dr. Brook Niemic, D.V.M., Diplomate, American Veterinary Dental College, the MILTEX® NIEMIEC Veterinary Extraction Kit provides surgical and dental instrumentation required for companion animal dental extractions.

REF# 6806 MILTEX® Niemic Veterinary Extraction Instrument Kit Includes 1 each of:

REF	Descriptions	Feature	Size	
4-7	#3 Scalpel Handle	-	-	(1)
73-64	Baby MOLT Periosteal Elevator	-	-	(2)
DEFF	Extracting Forceps	universal, mini	-	(3)
5D-324	LA GRANGE Scissors	curved, one serrated blade, angled shank	4-1/4" (10.8 cm)	(4)
8-15TC	OLSEN-HEGAR Needle Holder	with suture scissors	5-1/2" (14 cm)	(5)
6-124	BROWN-ADSON Tissue Forceps	7x7 teeth	4-3/4" (12.1 cm)	(6)
5-16	Operating Scissors (suture scissors)	straight, sharp/blunt	5-1/2" (14 cm)	(7)
DELLUXS2	Miltex Luxating Elevator	straight	2 mm	(8)
DELLUXS3	Miltex Luxating Elevator	straight	3 mm	(9)
DELLUXS5	Miltex Luxating Elevator	straight	5 mm	(10)
DELLUXC3	Miltex Luxating Elevator	curved	3 mm	(11)
DELLUXC5	Miltex Luxating Elevator	curved	5 mm	(12)
3-085009	Miltex #9 Storage Cassette	-	8" L x 6" W x 1-3/16" H	(13)
-	Training DVD & Instructional Guide	-	-	(14)

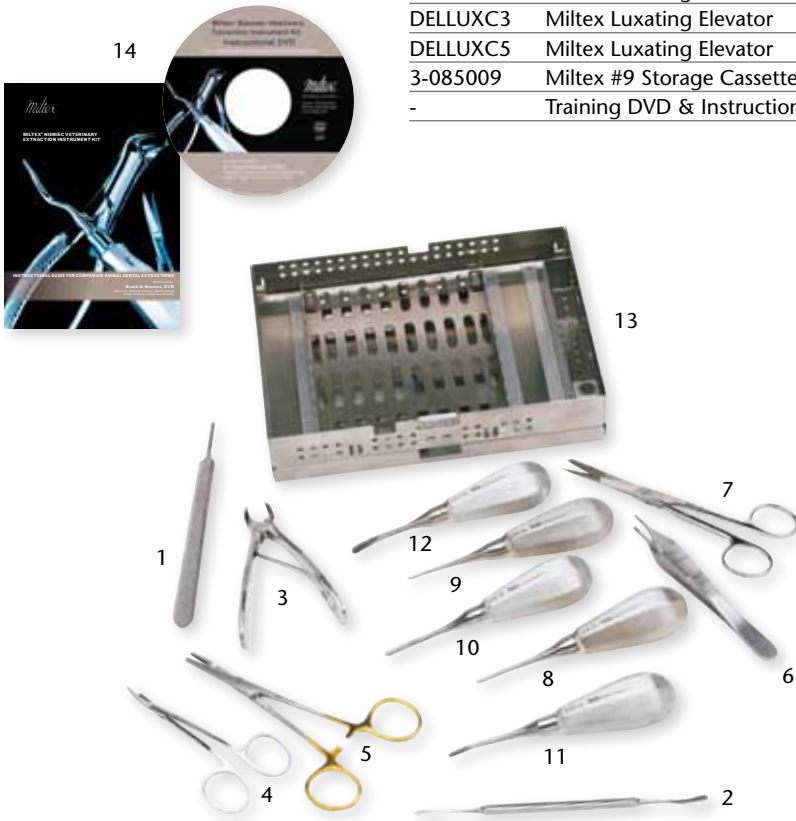

“Dental extractions are a very common veterinary procedure. As common as they are, they are not a simple undertaking and should be approached with the same in-depth preparation as any other surgical procedure. In this way, the practitioner will think through the procedure and properly prepare, avoiding common mistakes.”

“Having the proper equipment is an excellent first step. The instructional guide and training DVD is designed to help you use the instruments to their fullest extent.”

Dr. Brook Niemic, DVM

*Diplomate, American Veterinary Dental College
Fellow, Academy of Veterinary Dentistry
Veterinary Dental Specialties, San Diego, CA*



Creating buccal mucosal flap



Utilizing a properly sized periosteal elevator, the buccal mucosal flap is reflected



Initial elevation of the mesial buccal root

Clinical photos provided by Dr. Brook Niemic, DVM, Diplomate, American Veterinary Dental College
www.dogbeachdentistry.com

Miltex® Veterinary Winged Dental Elevator Kits

The Miltex® Winged Dental Elevators, developed and approved by Dr. Robert B. Wiggs, D.V.M., Diplomate, American Veterinary Dental College, ease the extraction process and provide the Veterinarian Professional with instrumentation that meets diverse clinical needs.

Winged Dental Elevators are shaped to improve instrument adaptation to the root structure. When used in a side-to-side rocking/twisting motion, the blades provide additional leverage, especially when used between teeth in the interdental space. The winged-blades will hook under the buccal bulge, improving the angle of direction in order to lift the tooth and root.



DELWNG5

Wing-Shaped Blade

Improves instrument-tooth adaptation. Gradually tapered for easy insertion into PDL.

Narrow Neck

Enhances visibility.

One-Piece German Stainless Steel Construction

Reduces chance of tip separating from handle.

Short Handle

Improves grip and control.

REF	Description
DELWBASIC	MILTEX® Winged Dental Elevator Basic Kit Contains 1 each:
DELWNG2	MILTEX Winged Dental Elevator Size 2 mm
DELWNG3	MILTEX Winged Dental Elevator Size 3 mm
DELWNG4	MILTEX Winged Dental Elevator Size 4 mm
DELWNG5	MILTEX Winged Dental Elevator Size 5 mm
3-083005	MILTEX #5 Storage Cassette 8" L x 3-13/16" W x 1-1/8" H



REF	Description
DELWDELUX	MILTEX® Winged Dental Elevator Deluxe Kit Contains 1 each:
DELWNG2	MILTEX Winged Dental Elevator Size 2 mm
DELWNG3	MILTEX Winged Dental Elevator Size 3 mm
DELWNG4	MILTEX Winged Dental Elevator Size 4 mm
DELWNG5	MILTEX Winged Dental Elevator Size 5 mm
DELWNG6	MILTEX Winged Dental Elevator Size 6 mm
DELWNG7	MILTEX Winged Dental Elevator Size 7 mm
DELWNG8	MILTEX Winged Dental Elevator Size 8 mm
3-084007	MILTEX #7 Storage Cassette 8" L x 4-7/8" W x 1-1/8" H



Miltex® Luxating Dental Elevator Kit

The Miltex® Luxating Dental Elevator Kit is a complete set of elevators ranging in size from 2 mm through 5 mm with curved and straight tip designs. The Luxators are designed to cut periodontal ligament while easing the tooth from the socket by rocking and cutting, rather than by lifting and prying like a conventional elevator.

REF	Description	Length
DELLUXKIT	Miltex® Luxating Dental Elevator Kit Contains 1 each:	
DELLUXC2	Miltex Luxator- curved tip 2 mm	4-1/2" (11.4 cm)
DELLUXC3	Miltex Luxator- curved tip 3 mm	4-1/2" (11.4 cm)
DELLUXC4	Miltex Luxator- curved tip 4 mm	4-1/2" (11.4 cm)
DELLUXC5	Miltex Luxator- curved tip 5 mm	4-1/2" (11.4 cm)
DELLUXS2	Miltex Luxator- straight tip 2 mm	4-1/2" (11.4 cm)
DELLUXS3	Miltex Luxator- straight tip 3 mm	4-1/2" (11.4 cm)
DELLUXS4	Miltex Luxator- straight tip 4 mm	4-1/2" (11.4 cm)
DELLUXS5	Miltex Luxator- straight tip 5 mm	4-1/2" (11.4 cm)
3-084007	Miltex #7 Storage Cassette	8" L x 4-7/8" W x 1-1/8" H

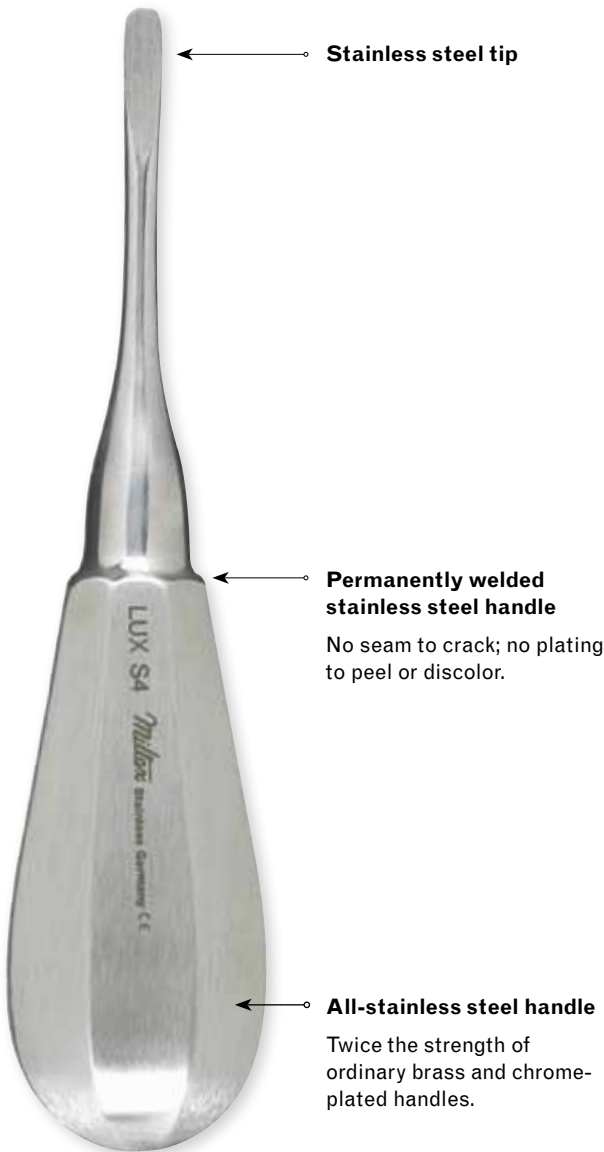

Luxating Elevator - proper grasp/positioning



Elevator placement into the periodontal space



Miltex® Luxating Dental Elevator Kit

Clinical photos provided by Dr. Brook Niemiec, DVM, Diplomate, American Veterinary Dental College
www.dogbeachdentistry.com

Integra™ Miltex® CryoSolutions®

CryoSolutions® is an innovative yet simple device for delivery of high performance Liquefied Nitrous Oxide which allows the clinician to pinpoint the treatment site for rapid freezing and efficacious destruction of unwanted tissue.

This convenient, in-office treatment utilizes the recognized cryogenic advantage of Liquefied Nitrous Oxide vs. competitive chemical agents. This treatment is appropriate for a variety of lesions due to the effectively low and destructive temperature delivered to the treatment site.

Economical - Convenient - Effective

- **A low \$1.50 cost per patient application.**
(Compare to the higher cost of competitive chemical agents)
- **CryoSolutions nitrous oxide will not evaporate from cartridge.**
(CryoSolutions is ready for use when you are!)
- **Lightweight, portable with pinpoint accuracy.**
(Lesions are precisely "targeted" with CryoSolutions)
- **Glass tips are autoclavable.**

CryoSolutions, Product Listing and Replacement Parts

REF	Description
33510	Complete set, includes unit with standard 1mm wide tip, one cartridge (23.5 g N2O), metal pin, user manual and plastic case
33511	Standard 1 mm wide glass tip
33512	Dermatology 2 mm wide glass tip
33513	Dermatology 3 mm wide glass tip
33514	Dermatology 4 mm wide glass tip
33516	10 Pack of Cartridges (23.5 g N2O) medical grade, with threaded safety valve
33517	4 Pack of Cartridges (23.5 g N2O) medical grade, with threaded safety valve
33519	CryoSolutions® replacement plastic carrying case with protective foam
33520	CryoSolutions® replacement metal pin

Contact Integra Miltex Customer Service for CPT Code Summary



Miltex® WELDIN Veterinary Periodontal Instrument Kit For Routine Treatment

The Miltex® WELDIN Periodontal Instrument Kit is a complete collection of veterinary dental instruments and accessories for oral examinations and routine periodontal prophylaxis procedures on companion animal patients.

Dedicated to the advancement of veterinary dentistry since 1981, Carol Weldin, RDH, BS, in conjunction with Miltex, Inc., has specifically selected each diagnostic and working instrument and accessory for the varying lengths and shapes of tooth structures, accessibility to anterior and posterior teeth, sulcus depths, diversity of patients and ease of instrument care and maintenance.

6809	Miltex Weldin Veterinary Perio Instrument Kit Contains:
SVET-5450	GripLite® S6 Mirror Handle, single-ended, cone-socket
67-696/3*	#3 Cone Socket Front Surface Mirror, 1 mirror
67-696/4*	#4 Cone Socket Front Surface Mirror, 1 mirror
SVET-23E/18P	GripLite S6 #23 Explorer/18 mm Probe, double-ended
SVET-5004	GripLite S6 J33/H5 (Jacquette 33/1YS Scaler)
SVET-767	GripLite S6 Morse 0-00 Scaler
SVET-5201	GripLite S6 Columbia 13/14 Universal Curette
SVET-5202	GripLite S6 Barnhart 1/2 Universal Curette
DTST**	Plastic Resin Sharpening Test Sticks, Clear, 1 stick
STN-ARK-CON	Conical Arkansas Sharpening Stone, 1 stone
STN-ARK-FLT-4	#4 Flat Arkansas Sharpening Stone, 1 stone
3-084107	Miltex Sterilization & Storage Cassette 8"L x 4-7/8"W x 1-1/8"H

*(not sold individually – 67-696/3 and 67-696/4 are 12/bx)

** (not sold individually – DTST is 6/pk)

Check with your distributor

**INCLUDES
TRAINING DVD &
INSTRUCTIONAL
CHART!**



“The Miltex® Weldin Periodontal kit is easy to use and maintain. The instruments are color coded for ease of use. Every general and specialty practice should have this wonderful kit on hand to assist them in providing proper periodontal therapy for their patients.”

Sara L. Sharp CVT VTS (Dentistry)

Secretary, Academy of
Veterinary Dental Technicians



SVET-5450
67-696/3
67-696/4



SVET-23E/18P



SVET-23E/18P



Jacquette



SVET-5004 H5



SVET-767



SVET-5201

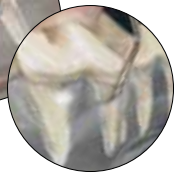

SVET-5202

MILTEX® MICROSURGICAL INSTRUMENTS

- Microsurgical Instrument Kit.....344
- Microsurgery Scissors..... 345-346
- Micro Vessel Clips..... 347
- Microsurgery Forceps 348-350
- Microsurgery Alligator Ear Forceps 351
- Microsurgical Needle Holders..... 352
- Microsurgery Rongeurs 353
- Microsurgery Retractors.....354-355



Microsurgical Instrument Kit

REF# 6890 *with MILTEX® Storage Cassette & Mat

MILTEX® Microsurgical Kit Includes 1 each of:

REF	Description	Type	Length	
8-4	DERF Needle Holder	serrated jaws, 4000 teeth per sqare inch	4-3/4" (12.1cm)	(1)
5-300	Iris Scissors	straight	4" (10.2 cm)	(2)
17-305X	SWISS Jeweler Style Forceps	non-magnetic stainless steel, style 5, micro-fine	4-3/8" (11.2 cm)	(3)
18-948	McPHERSON Micro Iris Suturing Forceps	straight, smooth platform 0.3 mm X 5 mm, no teeth	3-1/2" (8.9 cm)	(4)
18-1625	McPHERSON-VANNAS Micro Iris Scissors	straight, sharp points	3-1/4" (8.3 cm)	(5)
18-34	Plain Wire Speculum	blades 15 mm wide	2-1/2" (6.4 cm)	(6)
10-2-ST	MILTEX Probe	double ended, malleable, sterling	4-1/2" (11.4 cm)	(7)
4-6835	MILTEX Storage Cassette	dimensions 6-1/2" x 6-1/4" x 1-1/4"	-	(8)
4-6835MAT	MILTEX Storage Cassette Mat	-	-	(9)
REF 6890-NC	*without MILTEX® Storage Cassette & Mat	-	-	(10)

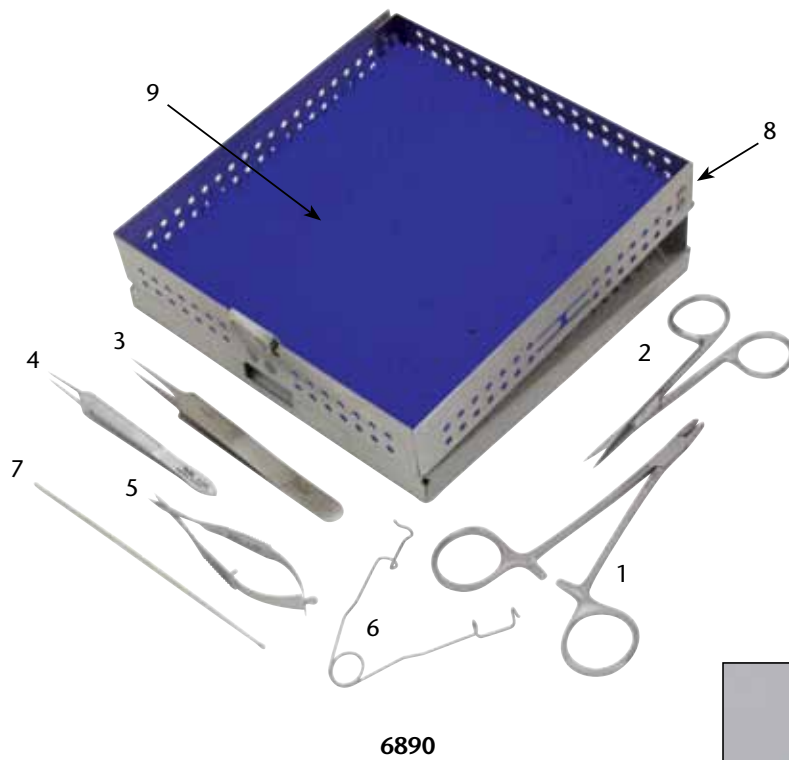

6890-NC

Microsurgery Scissors

REF	Description	Tips	Type	Length
17-2060	MILTEX Microsurgery Scissors	sharp	straight, 8 mm blades, flat handles	5-3/4" (14.6 cm)
17-2040	MILTEX Microsurgery Scissors	sharp	curved, 8 mm blades, flat handles	5-3/4" (14.6 cm)
17-2150	MILTEX Microsurgery Scissors	sharp	straight, 6 mm blades, round handles	6" (15.2 cm)
17-2100	MILTEX Microsurgery Scissors	sharp	curved, 6 mm blades, round handles	6" (15.2 cm)
17-2160	MILTEX Microsurgery Scissors	sharp	straight, 6 mm blades, round handles	7-1/8" (18.1 cm)
17-2110	MILTEX Microsurgery Scissors	sharp	curved, 6 mm blades, round handles	7-1/8" (18.1 cm)
18-1625	MCPHERSON-VANNAS Micro Iris Scissors	straight, sharp	-	3-1/4" (8.3 cm)
18-1626	MCPHERSON-VANNAS Micro Iris Scissors	curved, sharp	-	3-1/4" (8.3 cm)
18-1630	Micro VANNAS Scissors	straight, ultrafine blades	-	3-1/4" (8.3 cm)
18-1631	Micro VANNAS Scissors	curved, ultrafine blades	-	3-1/4" (8.3 cm)
18-1633	Micro Scissors	straight, superfine blades	-	3-1/4" (8.3 cm)
18-1634	Micro Scissors	curved, superfine blades	-	3-1/4" (8.3 cm)
PM-4956*	Hood Micro Stitch Scissors	sharp	curved	4-1/2" (11.4 cm)

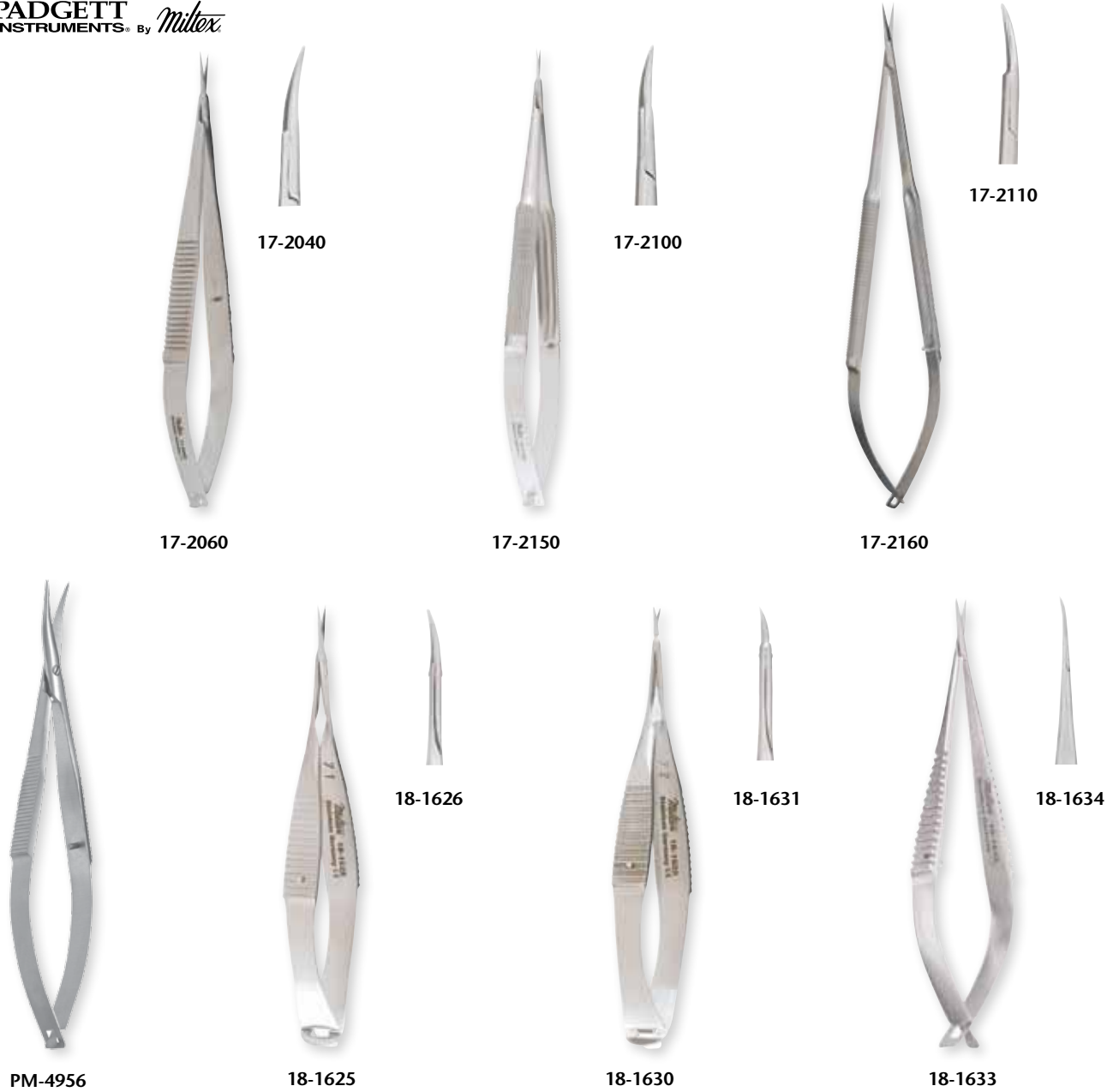

Microsurgery Scissors

REF	Description	Tip	Length
17-115	Pencil-Type Microsurgery Scissors	delicate, 4 mm blades, straight	7-1/4" (18.4 cm)
17-215	Pencil-Type Microsurgery Scissors	delicate, 4 mm blades, angled	7-1/4" (18.4 cm)
17-220	Microsurgery Scissors	8 mm blades, angled	7-1/4" (18.4 cm)
18-1618	Micro Iris Scissors	straight, sharp points	4" (10.2 cm)
18-1619	Micro Iris Scissors	curved, sharp points	4" (10.2 cm)



17-115



17-215



17-220



18-1618



18-1619

Micro Vessel Clips

REF	Description	Type	Jaws	Length
17-4000	Micro Vessel Clip	straight	0.75 mm x 4 mm jaws	-
17-4005	Micro Vessel Clip	straight	0.8 mm x 6 mm jaws	-
17-4010	Micro Vessel Clip	straight	1 mm x 8 mm jaws	-
17-4015	Micro Vessel Clip	straight	1.5 mm x 10 mm jaws	-
17-4050	Micro Vessel Clip	slight curve	1 mm x 6 mm jaws	-
17-4060	Micro Vessel Clip	full curve	1 mm x 6 mm jaws	-
17-4070	Micro Vessel Clip	45° angle	1 mm x 6 mm jaws	-
17-4030	Micro Clip Approximator Set	15 mm spread	2 mm x 6 mm jaws	-
17-4100	Applying Forceps for Micro Clips	with lock	-	5-3/4" (14.6 cm)
17-4102	Applying Forceps for Micro Clips	-	-	5-1/2" (14 cm)



17-4100



17-4102

Microsurgery Forceps

REF	Description	Teeth	Type	Length
17-2500	Micro ADSON Tissue Forceps	1 x 2	tips 0.5 mm wide	4 3/4" (12.1 cm)
17-2510	Micro ADSON Dressing Forceps	-	serrated jaws 0.5 mm wide	4 3/4" (12.1 cm)
17-2600	JACOBSON Micro Mosquito Forceps	-	straight, extremely delicate	5" (12.7 cm)
17-2602	JACOBSON Micro Mosquito Forceps	-	curved, extremely delicate	5" (12.7 cm)
18-835	BONN Micro Suturing Forceps	1 x 2	0.12 mm, with tying platform	2-3/4" (7.0 cm)
18-836	BONN Micro Suturing Forceps	1 x 2	0.12 mm, with tying platform	3-3/4" (9.5 cm)
18-837	MCPHERSON Micro Corneal Suturing Forceps	1 x 2	straight, 0.2 mm, with tying platform	3-1/2" (8.9 cm)
18-838	MCPHERSON Micro Corneal Suturing Forceps	1 x 2	angled, 0.2 mm, with tying platform	3-1/2" (8.9 cm)



17-2500



17-2510



17-2600



17-2602



18-835
18-836



18-837



18-838

Microsurgery Forceps

REF	Description	Type	Style	Length
17-301	SWISS Jeweler Style Forceps	non-magnetic stainless steel	1, fine	4-3/4" (12.1 cm)
17-302	SWISS Jeweler Style Forceps	non-magnetic stainless steel	2, strong, fine	4-3/4" (12.1 cm)
17-303	SWISS Jeweler Style Forceps	non-magnetic stainless steel	3, narrow, fine	4-3/4" (12.1 cm)
17-303C	SWISS Jeweler Style Forceps	non-magnetic stainless steel	3C, narrow, fine	4-3/8" (11.2 cm)
17-303X	SWISS Jeweler Style Forceps	non-magnetic stainless steel	3, micro-fine	4-3/4" (12.1 cm)
17-304	SWISS Jeweler Style Forceps	non-magnetic stainless steel	4, fine	4-3/8" (11.2 cm)
17-305	SWISS Jeweler Style Forceps	non-magnetic stainless steel	5, super fine	4-3/8" (11.2 cm)
17-305X	SWISS Jeweler Style Forceps	non-magnetic stainless steel	5, micro-fine	4-3/8" (11.2 cm)



17-301

17-302

17-303

17-303C

17-303X

17-304

17-305

17-305X

Microsurgery Forceps

REF	Description	Type	Length
17-306	SWISS Jeweler Style Forceps	non-magnetic stainless steel, style 6, pickup	4-1/2" (11.4 cm)
17-307	SWISS Jeweler Style Forceps	non-magnetic stainless steel, style 7, fine, curved	4-1/2" (11.4 cm)
17-307X	SWISS Jeweler Style Forceps	non-magnetic stainless steel, style 7, micro-fine, curved	4-1/2" (11.4 cm)
18-948	MCPHERSON Micro Iris Suturing Forceps	no teeth, straight, smooth platform 0.3 mm x 5 mm	3-1/2" (8.9 cm)
18-949	MCPHERSON Micro Iris Suturing Forceps	no teeth, angled, smooth platform 0.3 mm x 5 mm	3-1/2" (8.9 cm)
17-1100	RHOTON Micro Suture Forceps	straight, with 0.7 mm tying platform	7" (17.8 cm)
17-1150	RHOTON Micro Forceps	straight, 0.3 mm tips	7" (17.8 cm)



17-306



17-307



17-307X



18-948



18-949



17-1100



17-1150

Microsurgery Alligator Ear Forceps

Micro Alligator Ear Forceps are the most delicate instruments for otological surgery. Excellent for foreign body removal and ideal for precision grasping and extraction of cerumen from the ear canal. Serrated and oval cup jaw patterns are available in sizes 0.5 mm to 0.8 mm wide in your choice of stainless or ebony finish (see 19-2150-B).

REF	Description	Type	Shaft Length
19-2081	Micro Alligator Ear Forceps	serrated jaws, 0.6 mm wide	3-1/4" (8.3 cm)
19-2081-B	Micro Alligator Ear Forceps	serrated jaws, 0.6 mm wide, ebony finish	3-1/4" (8.3 cm)
19-2090	Micro Alligator Ear Forceps	oval cup jaws, 0.5 mm wide	3-1/4" (8.3 cm)
19-2090-B	Micro Alligator Ear Forceps	oval cup jaws, 0.5 mm wide, ebony finish	3-1/4" (8.3 cm)
19-2100	Micro Alligator Ear Forceps	serrated jaws, 0.8 mm wide	3-1/4" (8.3 cm)
19-2100-B	Micro Alligator Ear Forceps	serrated jaws, 0.8 mm wide, ebony finish	3-1/4" (8.3 cm)
19-2138	HOUSE Micro Strut Forceps	smooth jaws, 0.8 mm wide	2-3/4" (7 cm)
19-2110	Micro Alligator Ear Forceps	oval cup jaws, 0.8 mm wide	3-1/4" (8.3 cm)
19-2110-B	Micro Alligator Ear Forceps	oval cup jaws, 0.8 mm wide, ebony finish	3-1/4" (8.3 cm)
19-2150	BELLUCCI Micro Ear Scissors	4 mm blades	2-3/4" (7 cm)
19-2150-B	BELLUCCI Micro Ear Scissors	4 mm blades, ebony finish	2-3/4" (7 cm)

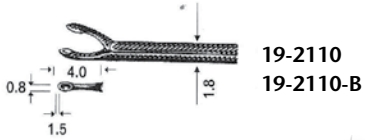
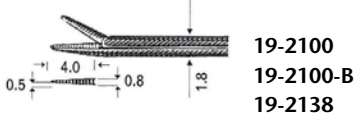
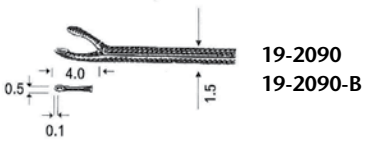
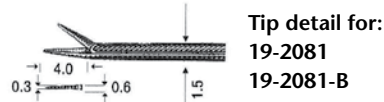

19-2081
19-2081-B



19-2090
19-2090-B



19-2100
19-2100-B
19-2138



19-2110
19-2110-B



19-2150
19-2150-B

Microsurgical Needleholders

REF	Description	Type	Length
8-4TC	DERF Needle Holder	serrated jaws, 4000 teeth per sq. inch	4-3/4" (12.1 cm)
8-14TC	OLSEN-HEGAR Needle Holder with Suture Scissors	extra delicate, serrated jaws, 4000 teeth per sq. inch	4-3/4" (12.1 cm)
17-1000	MILTEX Microsurgery Needle Holders	round handles, 0.6 mm tips, curved jaws	5-1/4" (13.3 cm)
17-1020	MILTEX Microsurgery Needle Holders	round handles, 0.6 mm tips, curved jaws, with lock	5-1/4" (13.3 cm)
17-980	MILTEX Microsurgery Needle Holders	round handles, 0.6 mm tips, straight jaws	7-1/8" (18.1 cm)
17-1024	MILTEX Microsurgery Needle Holders	round handles, 0.6 mm tips, straight jaws, with lock	7-1/8" (18.1 cm)
17-1010	MILTEX Microsurgery Needle Holders	round handles, 0.6 mm tips, curved jaws	7-1/8" (18.1 cm)
17-1025	MILTEX Microsurgery Needle Holders	round handles, 0.6 mm tips, curved jaws, with lock	7-1/8" (18.1 cm)
17-1090TC	JACOBSON Microvascular Needle Holder	straight, with lock, Carb-N-Sert® jaws, 16000 teeth per sq. inch	7" (17.8 cm)
17-1091TC	JACOBSON Microvascular Needle Holder	curved, with lock, Carb-N-Sert® jaws, 16000 teeth per sq. inch	7" (17.8 cm)
17-1092TC	JACOBSON Microvascular Needle Holder	straight, with lock, Carb-N-Sert® jaws, 16000 teeth per sq. inch	8-1/2" (21.6 cm)



8-4TC



8-14TC



17-1000
17-1020



17-1010
17-1025



17-1090TC
17-1092TC

Microsurgery Rongeurs

REF	Description	Jaws	Length
17-4800	Micro FRIEDMAN Rongeur	straight, 1.3 mm wide jaws, very delicate	5-1/2" (14 cm)
17-4801	Micro FRIEDMAN Rongeur	curved, 1.3 mm wide jaws, very delicate	5-1/2" (14 cm)
17D-4802	Micro FRIEDMAN Rongeur	90° angled, 1.3 mm wide jaws, very delicate	5-1/2" (14 cm)



17-4801



17-4800

17D-4802

Microsurgery Retractors

REF	Description	Type	Size
18-2	LANCASTER Eye Speculum	15 X 5 mm blades	3-1/4" (8.3 cm)
18-4	KNAPP Eye Speculum	15 X 6 mm blades	3-1/4" (8.3 cm)
18-10	CASTROVIEJO Eye Speculum	18 X 5 mm O.D. large blades	4" (10.2 cm)
18-22	WILLIAMS Eye Speculum	15 X 5 mm large blades	3-1/4" (8.3 cm)
18-24	WILLIAMS Eye Speculum	11 X 5 mm small blades	2-3/4" (7.0 cm)
18-35	BARRAQUER Eye Speculum	large blades, 14 mm wide	1-3/4" (4.4 cm)
18-46	SMITH Eye Speculum	blades 15 mm wide with concealed spring	3" (7.6 cm)
18-47	SAUER Eye Speculum	petite size, blades 10 mm wide	1-1/4" (3.2 cm)
18-50	MURDOCK Eye Speculum	blades 15 mm wide, chrome	2-1/4" (5.7 cm)



18-2



18-4



18-10



18-22
18-24



18-35



18-46



18-47



18-50

Microsurgery Retractors, Probes & Punch

REF	Description	Type	Size
18-63	COOK Eye Speculum	petite size, 9 mm blades	1-7/8" (4.7 cm)
18-66	MELLINGER Eye Speculum	solid blades 15 mm blades	2-3/4" (7 cm)
18-80	AGRICOLA Lacrimal Sac Retractor	3 X 3 pointed prongs 4 mm deep	1-1/2" (3.8 cm)
18-84	MELLER Lacrimal Sac Retractor	3 X 3 prongs 3 mm deep, sharp-pointed prongs	2-7/8" (7.3 cm)
18-88	GOLDSTEIN Lacrimal Sac Retractor	3 X 3 pointed prongs 5 mm deep	1-1/8" (2.8 cm)
28-104	BARR Fistula Probe	8" (20.3 cm) sterling shaft, eye at tip	11" (27.9 cm)
28-108	PRATT Rectal Probe	7-3/4" (19.7 cm) sterling shaft	10" (25.4 cm)
76-5	Rubber Dam Punch	Ainsworth	-



18-63



18-66



18-80



18-84



18-88



28-104



28-108



76-5

MILTEX® GYNECOLOGICAL & OBSTETRICAL INSTRUMENTS

Sponge Forceps 357-358
Obstetrical Forceps 359
Hooks and Forceps 360



Sponge Forceps

REF	Description	Type	Length
7-600	FOERSTER Sponge Forceps	straight, serrated jaws	9-1/2" (24.1 cm)
7-602	FOERSTER Sponge Forceps	straight, smooth jaws	9-1/2" (24.1 cm)
7-604	FOERSTER Sponge Forceps	straight, serrated jaws	7" (17.8 cm)
7-606	FOERSTER Sponge Forceps	straight, smooth jaws	7" (17.8 cm)
7-610	FOERSTER Sponge Forceps	curved, serrated jaw	9-1/2" (24.1 cm)
7-612	FOERSTER Sponge Forceps	curved, smooth jaws	9-1/2" (24.1 cm)
7-614	FOERSTER Sponge Forceps	curved, serrated jaws	7" (17.8 cm)
7-616	FOERSTER Sponge Forceps	curved, smooth jaws	7" (17.8 cm)
30-2505	KELLY Sponge or Placenta Forceps	slightly curved, serrated ring jaws	12-1/2" (31.8 cm)

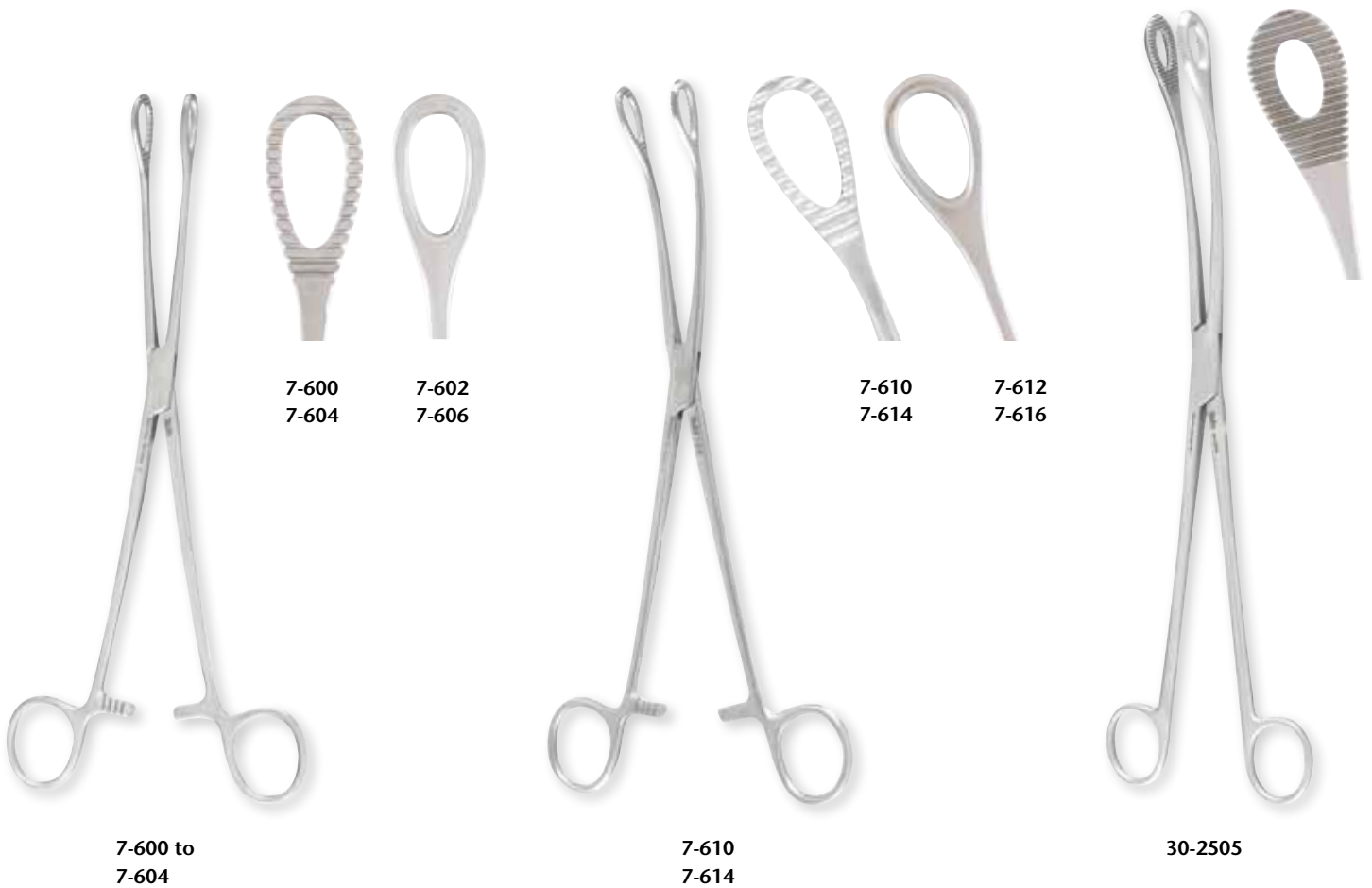

Sponge Forceps

Ref	Description	Type	Length
7-620	BOZEMAN Sponge Forceps	straight	10-1/2" (26.7 cm)
7-622	BOZEMAN Sponge Forceps	double curved	10-1/2" (26.7 cm)
7-624	BOZEMAN Sponge Forceps	double curved, one large ring	10-1/2" (26.7 cm)
7-630	FLETCHER Sponge Forceps	straight	9-1/2" (24.1 cm)
7-632	FLETCHER Sponge Forceps	curved	9-1/2" (24.1 cm)



7-620



7-622



7-624



7-630



7-632

Obstetrical Instruments

REF	Description	Type	Length
20-4	VIENNA Speculum	small size, standard pattern	5-3/4" (14.6 cm)
20-12	TIECK-HALLE Infant Speculum	-	5-3/4" (14 cm)
30-10	GRAVES Vaginal Speculum	original model, small size	3/4" (1.9 cm) X 3" (7.6 cm)
30-1718	BALLENTINE Hysterectomy Forceps	straight, longitudinal serrations, single tooth	8-1/2" (21.6 cm)
30-1730	LONG Hysterectomy Forceps	curved, longitudinal serrations, 1 x 2 teeth	7-1/2" (19.1 cm)
30-1815	PEAN Hysterectomy Forceps	curved, longitudinal serrations	10-1/4" (26 cm)
30-2530	WINTER Placenta Forceps	straight, cup jaws	11" (27.9 cm)
30-2535	WINTER Placenta Forceps	curved, cup jaws	11" (27.9 cm)



20-4
20-12



30-10



30-1718



30-1730



30-1815



30-2530
30-2535

Hooks and Forceps

Ref	Description	Type	Length
V930-2100	Obstetrical Caesarean Forceps	with removable rubber jaws	12" (30.5 cm)
V930-2101	Bovine Cervical Forceps	-	-
V930-2102	LINDES Embryotomy Knife	-	-
V930-2103	Obstetrical Forceps	-	-
V930-2104	MCLEAN Whelping Forceps	small breed	8" (20.3 cm)
V930-2105	RUGGEBERGS obstetrical double eye hook	spring type	5-1/2" (14 cm)
V930-2106	OSTERTAGS Blunt Eye Hook	-	-
V930-2107	KREY Hook	double action	8" (20.3 cm)
V930-2108	GUENTHERS Embryotomy Knife	-	-



V930-2100



V930-2104



V930-2105



V930-2107

MILTEX® OPHTHALMIC INSTRUMENTS

Veterinary Eye Kit.....	362
Tonometer.....	363
Laser Eye Shields.....	364
Ophthalmic Scissors.....	365-366
Knives.....	367
Ophthalmic Forceps.....	368-370
Ophthalmic Needle Holders.....	371
Ophthalmic Specula.....	372-373

Basic Veterinary Eye Kit

REF# 6830 Basic Veterinary Eye Kit includes:

Qty.	REF	Description	Length	
1	4-7	#3 Scalpel Handle	-	(1)
1	18-35	BARRAQUER Wire Eye Speculum	-	(2)
1	18-780	Eye Dressing Forceps	4" (10.2 cm)	(3)
1	18-1462	STEVENS Tenotomy Scissors	4-1/8" (10.5 cm) straight	(4)
1	18-1202	DESMARRES-CHALAZION Forceps	3-1/2" (8.9 cm)	(5)
1	18-1828	CASTROVIEJO Needle Holder	5-1/2" (14 cm) straight	(6)
1	3-6835	Storage Cassette	6-1/2" x 6-1/4" x 1-1/4"	(7)

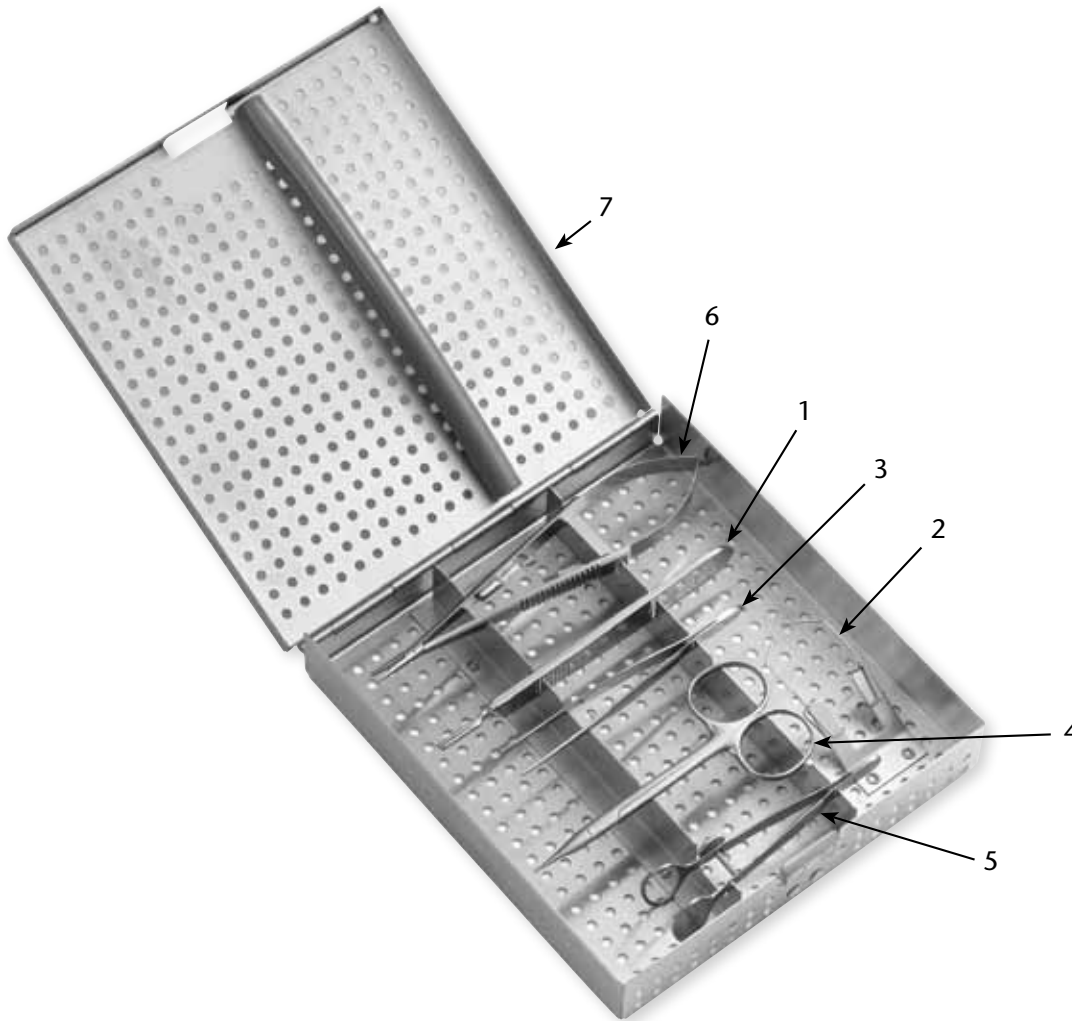

6830

Ophthalmic General

Schiotz Tonometers are constructed with jewelled hammers to minimize friction and feature inclined scale markings to allow reading from above. Schiotz Tonometers are autoclavable and are etched for accuracy.

Each unit is supplied with certification that it meets the specifications established by the Committee on Standardization of Tonometers of the A.A.O.O. Each Schiotz Tonometer is individually packaged in a fitted case with weights and a test block.

REF	Description
18-132	Schiotz Tonometers Original Model, with 3 weights (5.5, 7.5 & 10 g), stainless steel plunger, footplate & test block, remainder made of rust free materials
18-132A	Same as no. 132, but with ALLEN Plunger Retractor*
18-134	Schiotz Tonometers Improved Model, with 4 weights (5.5, 7.5, 10 & 15 g), mirror insert on scale reduces error of parallax, made entirely of stainless steel
18-134A	Same as no. 134, but with ALLEN Plunger Retractor*
18-139	Sterilizing Case for Schiotz Tonometers 6-1/2" (16.5 cm) x 3-1/2" (8.9 cm) x 1-1/4" (3.2 cm) fitted to firmly hold tonometer, weights & test block

* Allen Plunger Retractor holds plunger in retracted position, flush with footplate until tonometer is in place on cornea. This feature can potentially reduce damage to corneal tissue.



18-132 to
18-134A



18-139

Lid Shields / Covers

REF	Description	Type	Length
PM-4311*	SMITH Corneal Shield	autoclavable, green, latex-free	21 mm diameter
PM-4312*	SMITH Corneal Shield	non-autoclavable, white	21 mm diameter
PM-5010*	Laser Eye Shield	non-glare, autoclavable	1" (25 mm) diameter
PM-5012*	Laser Eye Shield Kit	2 Shields PM-5010, 1 suction handle PM-5015	-
PM-5015*	Spare Suction Handle	for Laser Eye Shield, fits PM-5010 & PM-5012	-
PM-5020*	JAEGER Lid Plate	21 mm & 24 mm width	4-1/4" (10.8 cm)
18-120	JAEGER Lid Plate	20 mm & 23 mm width	4-1/4" (10.8 cm)
18-650	CASTROVIEJO Caliper	measuring & marking, graduated 0-20 mm	3-1/4" (8.3 cm)

* **PADGETT** INSTRUMENTS By *Miltex*



PM-4311
PM-4312



PM-5010
PM-5012



PM-5015



PM-5020



18-120



18-650

Ophthalmic Scissors

REF	Description	Type	Tip	Length
5-312	Strabismus Scissors	straight	-	4" (10.2 cm)
9-100	SPENCER Stitch Scissors	delicate	-	3-1/2" (8.9 cm)
9-101	SHORTBENT Stitch Scissors	curved, delicate	-	3-1/2" (8.9 cm)
18-1460	STEVENS Tenotomy Scissors	straight	short blades, sharp points	4-1/8" (10.5 cm)
18-1462	STEVENS Tenotomy Scissors	straight	short blades, blunt points	4-1/8" (10.5 cm)
18-1464	STEVENS Tenotomy Scissors	curved	short blades, sharp points	4-1/8" (10.5 cm)
18-1466	STEVENS Tenotomy Scissors	curved	short blades, blunt points	4-1/8" (10.5 cm)
18-1470	STEVENS Tenotomy Scissors	straight	long blades, sharp points	4-1/2" (11.4 cm)
18-1472	STEVENS Tenotomy Scissors	straight	long blades, blunt points	4-1/2" (11.4 cm)
18-1474	STEVENS Tenotomy Scissors	curved	long blades, sharp points	4-1/2" (11.4 cm)
18-1476	STEVENS Tenotomy Scissors	curved	long blades, blunt points	4-1/2" (11.4 cm)
18-1652	Eye Suture (GRADLE) Scissors	slightly curved	sharp points	3-3/4" (9.5 cm)



5-312



9-101

9-100



18-1464
18-1466

18-1460
18-1462



18-1474
18-1476

18-1470
18-1472



18-1652

Ophthalmic Scissors

REF	Description	Type	Tips	Length
18-1485	MCPHERSON-WESTCOTT Stitch Scissors	curved	very sharp tips, small blades	4-1/8" (10.5 cm)
18-1565	CASTROVIEJO Universal Corneal Scissors	curved	small blades, blunt tips	4-1/8" (10.5 cm)
18-1566	CASTROVIEJO Universal Corneal Scissors	curved	medium blades, blunt tips	4-1/4" (10.8 cm)
18-1567	CASTROVIEJO Universal Corneal Scissors	curved	large blades, blunt tips	4-1/4" (10.8 cm)
18-1568	CASTROVIEJO Universal Corneal Scissors	strongly curved	large blades, blunt tips	4-1/4" (10.8 cm)
18-1579	CASTROVIEJO Corneoscleral Scissors	-	small blades, right	4-1/8" (10.5 cm)
18-1580	CASTROVIEJO Corneoscleral Scissors	-	small blades, left	4-1/8" (10.5 cm)
18-1591	RICH Corneal Transplant Scissors	extremely delicate, strongly curved	large blades, left	4" (10.2 cm)
18-1592	RICH Corneal Transplant Scissors	extremely delicate, strongly curved	large blades, right	4" (10.2 cm)



18-1485



18-1565



18-1566

18-1567

18-1568



18-1579



18-1580



18-1591



18-1592

Knives, Dissector & Foreign Body Removal

REF	Description	Type	Length
18-330	GILL Corneal Knife	slightly curved 3.5 mm wide blade	4-3/4" (12.1 cm)
18-331	DESMARRES Corneal Dissector	3 X 8 mm blade	4-3/4" (12.1 cm)
18-350	TOOKE Corneal Knife	2.5 X 15 mm dissecting blade	4-1/2" (11.4 cm)
18-370	Foreign Body Needle	2 X 5 mm blade	4-3/4" (12.1 cm)
18-372	DAVIS Foreign Body Spud	0.8 mm blade	4-3/4" (12.1 cm)
18-374	DIX Foreign Body Spud	1.7 mm X 15 mm blade	4-3/4" (12.1 cm)
18-376	WALTON Foreign Body Gouge	round end	4-1/2" (11.4 cm)



18-330

18-331

18-350

18-370

18-372

18-374

18-376

Ophthalmic Forceps

REF	Description	Type	Length
18-827	TROUTMAN-BARRAQUER Colibri Type Corneal Utility Forceps	1 x 2 teeth, 0.4 mm, set at 45° angle, with tying platform	3" (7.6 cm)
18-828	TROUTMAN-BARRAQUER Colibri Type Corneal Utility Forceps	1 x 2 teeth, 0.12 mm, set at 45° angle, with tying platform	3" (7.6 cm)
18-835	BONN Micro Suturing Forceps	1 x 2 teeth, 0.12 mm, with tying platform	2-3/4" (7 cm)
18-836	BONN Micro Suturing Forceps	1 x 2 teeth, 0.12 mm, with tying platform	3-3/4" (9.5 cm)
18-814	GRAEFE Eye Dressing Forceps	straight, serrated	2-3/4" (7 cm)
18-816	GRAEFE Iris Forceps	straight, 1 x 2 teeth	2-3/4" (7 cm)
18-850	GRAEFE Fixation Forceps	standard jaws, 4.5 mm wide, with fine teeth	4-3/8" (11.2 cm)
18-852	GRAEFE Fixation Forceps	standard jaws, 4.5 mm wide, with fine teeth, non-magnetic	4-3/8" (11.2 cm)
18-854	GRAEFE Fixation Forceps	standard jaws, 4.5 mm wide, with fine teeth, with catch	4-3/8" (11.2 cm)
18-866	BISHOP-HARMON Dressing Forceps	fine cross serrated tips 0.5 mm wide	3-3/8" (8.6 cm)
18-867	BISHOP-HARMON Micro Tissue Forceps	delicate 0.3 mm 1 x 2 teeth	3-3/8" (8.6 cm)
18-868	BISHOP-HARMON Tissue Forceps	standard 0.7 mm 1 x 2 teeth	3-3/8" (8.6 cm)
18-946	HARMS Suturing Forceps	straight, with 11 mm wide handles, tying platform, 0.6 mm wide at tip	4-1/8" (10.5 cm)
18-947	HARMS Suturing Forceps	curved, with 11 mm wide handles, tying platform, 0.6 mm wide at tip	4-1/8" (10.5 cm)

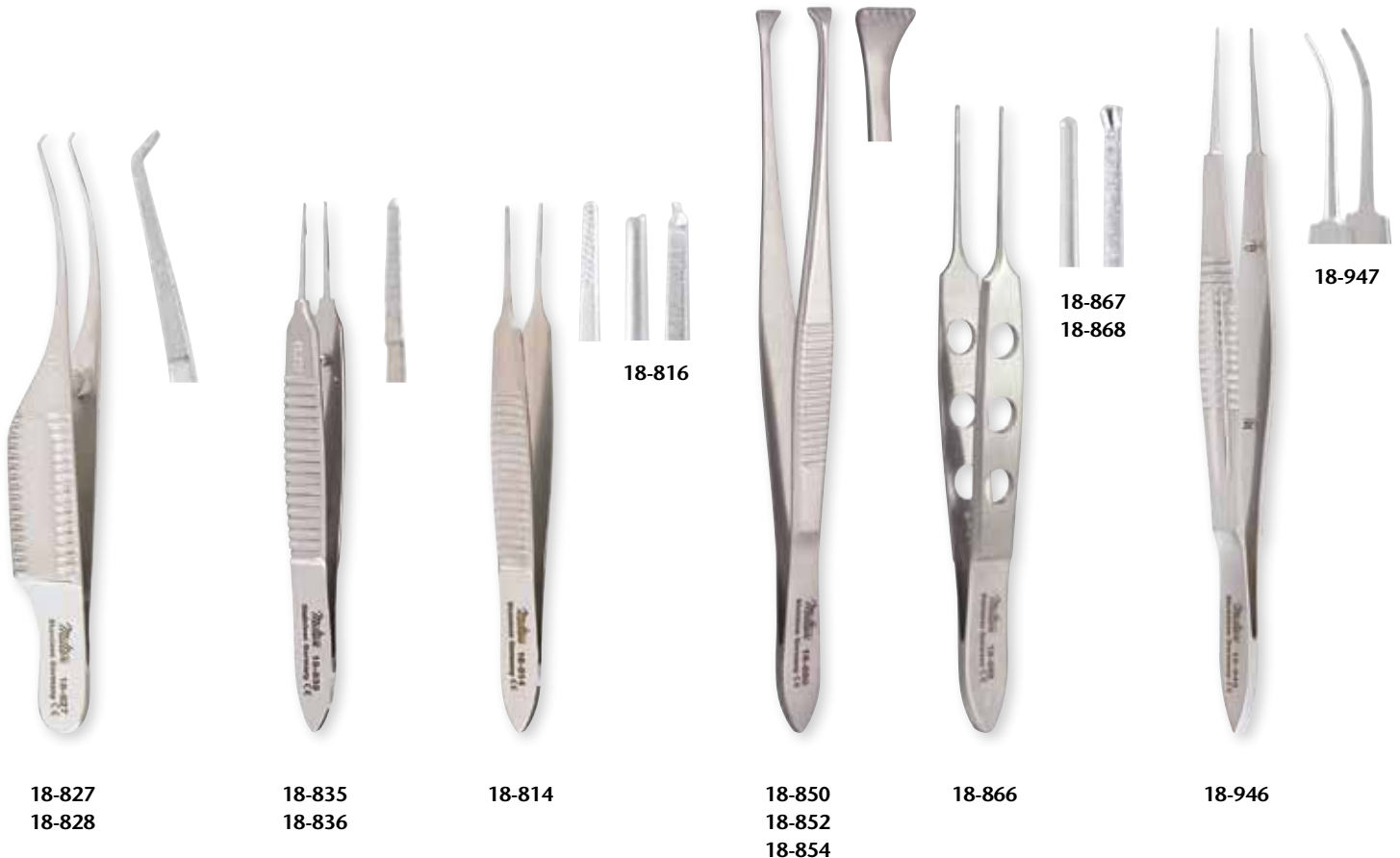

Ophthalmic Forceps

REF	Description	Type	Length
7-8	HALSTED Mosquito Forceps	straight, extra delicate	5" (12.7 cm)
7-10	HALSTED Mosquito Forceps	curved, extra delicate	5" (12.7 cm)
7-24	HARTMAN Mosquito Forceps	straight	3-1/2" (8.9 cm)
7-26	HARTMAN Mosquito Forceps	curved	3-1/2" (8.9 cm)
17-2600	JACOBSON Micro Mosquito Forceps	straight, extremely delicate	5" (12.7 cm)
17-2602	JACOBSON Micro Mosquito Forceps	curved, extremely delicate	5" (12.7 cm)
18-628	KIRBY Fixation Forceps	1 x 2 teeth, straight, with slide lock	4" (10.2 cm)
18-780	Eye Dressing Forceps	straight, standard pattern, 0.8 mm wide serrated tips	4" (10.2 cm)
18-782	Eye Dressing Forceps	half curved, standard pattern, 0.8 mm wide serrated tips	4" (10.2 cm)
18-784	Eye Dressing Forceps	full curved, standard pattern, 0.8 mm wide serrated tips	4" (10.2 cm)
18-786	Iris Tissue Forceps	1 x 2 teeth, straight, standard pattern, 0.8 mm wide tips	4" (10.2 cm)
18-788	Iris Tissue Forceps	1 x 2 teeth, half curved, standard pattern, 0.8 mm wide tips	4" (10.2 cm)
18-790	Iris Tissue Forceps	1 x 2 teeth, full curved, standard pattern, 0.8 mm wide tips	4" (10.2 cm)



Ophthalmic Forceps

REF	Description	Type	Length
18-1102	BEER Cilia Forceps	4 mm wide smooth jaws	3-1/2" (8.9 cm)
18-1107	SWISS Cilia and Suture Forceps	3 mm wide precision fitted diagonal jaws	3-3/4" (9.5 cm)
18-1112	BENNETT Cilia Forceps	cup shaped jaws 3 mm diameter	3" (7.6 cm)
18-1170	AYER Chalazion Forceps	inside ring diameter 8.5 mm, solid blade 8 mm diameter	3-1/2" (8.9 cm)
18-1182	HEATH Chalazion Forceps	inside ring 12 X 14 mm	4" (10.2 cm)
18-1200	DESMARRES Chalazion Forceps	small size, inside ring 11 X 17 mm	3-1/2" (8.9 cm)
18-1202	DESMARRES Chalazion Forceps	medium size, inside ring 12 X 23 mm	3-1/2" (8.9 cm)
18-1204	DESMARRES Chalazion Forceps	large size, inside ring 17 X 28 mm	3-1/2" (8.9 cm)
18-1208	FRANCIS Chalazion Forceps	inside ring 12 X 14 mm	3-3/4" (9.5 cm)
18-1220	PRINCE Trachoma Forceps	inside ring 8 X 10 mm	3-1/2" (8.9 cm)



18-1102



18-1107



18-1112



18-1170



18-1182



18-1200



18-1202



18-1204



18-1208



18-1220

Ophthalmic Needle Holders

REF	Description	Type	Length
18-1850	BARRAQUER Needle Holder	delicate jaws, straight without lock	5-1/2" (14 cm)
18-1852	BARRAQUER Needle Holder	delicate jaws, straight with lock	5-1/2" (14 cm)
18-1853	BARRAQUER Needle Holder	delicate jaws, curved with lock	5-1/2" (14 cm)
18-1854	BARRAQUER Needle Holder	delicate jaws, curved without lock	5-1/2" (14 cm)
18-1856	BARRAQUER Needle Holder	standard jaws, curved with lock	5-1/2" (14 cm)
18-1837	MCPHERSON Needle Holder for Microsurgery	curved mouth, tapered jaws	4" (10.2 cm)
8-26	BOYNTON Needle Holder	delicate	5" (12.7cm)



18-1850
18-1852



18-1853
18-1854
18-1856



18-1837



8-26

Ophthalmic Specula

REF	Description	Type	Length
18-9	KRATZ-BARRAQUER Wire Speculum	with wings	1-1/2" (3.8 cm)
18-17	BARRAQUER Wire Speculum	solid blades, small	1-1/3" (3.3 cm)
18-18	BARRAQUER Wire Speculum	solid blades, large	1-1/2" (3.8 cm)
18-34	Plain Wire Eye Speculum	blades 15 mm wide	2-1/2" (6.4 cm)
18-35	BARRAQUER Eye Speculum	large blades 14 mm wide	1-3/4" (4.4 cm)
18-36	BARRAQUER Eye Speculum	small blades 10 mm wide	1-1/4" (3.2 cm)
18-46	Temporal Approach Wire Speculum	spring on nasal side, solid blades	1-1/2" (3.8 cm)

*Note: all above instruments are non-magnetic



18-9



18-17



18-18

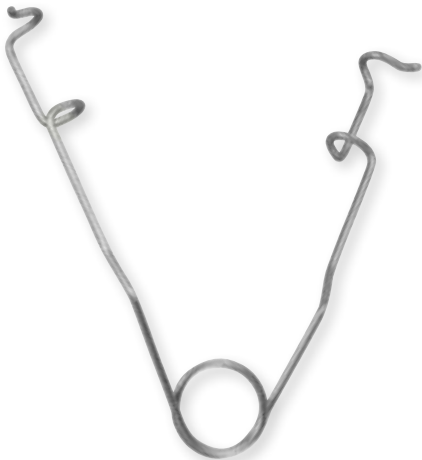

18-34

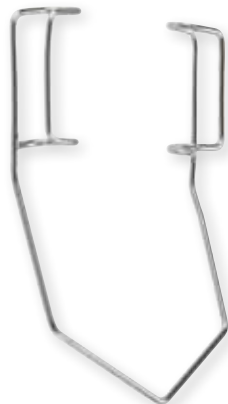

18-35
18-36



18-46

Ophthalmic Specula & Retractors

REF	Description	Type	Length
18-47	SAUER Eye Speculum	petite size, blades 10 mm wide	1-1/4" (3.2 cm)
18-50	MURDOCK Eye Speculum	blades 15 mm wide	2-1/4" (5.7 cm)
18-63	COOK Eye Speculum	petite size, 9 mm blades	1-7/8" (4.7 cm)
18-64	COOK Eye Speculum	small size, 11 mm blades	1-7/8" (4.7 cm)
18-66	MELLINGER Eye Speculum	solid blades 15 mm wide	2-3/4" (7 cm)
18-68	MELLINGER Eye Speculum	fenestrated blades 15 mm wide	2-3/4" (7 cm)
*Note: all above instruments are non-magnetic			
18-110	DESMARRES Lid Retractor	size 1, 12 mm	5-1/2" (14 cm)
18-112	DESMARRES Lid Retractor	size 2, 14 mm	5-1/2" (14 cm)
18-114	DESMARRES Lid Retractor	size 3, 16 mm	5-1/2" (14 cm)
18-116	DESMARRES Lid Retractor	size 4, 18 mm	5-1/2" (14 cm)



18-47



18-50

18-63
18-6418-66
18-68

18-110



18-112



18-114



18-116

MILTEX® ORTHOPEDIC INSTRUMENTS

Orthopedic Kit.....	376
Bone Holding Forceps & Clamps	377-380
Pin & Wire Instruments	381-384
Retractors	385-387
Osteotomes	388-392
Chisels & Gouges.....	393-395
Mallets	396-397
Rasps & Bone Files	398-400
Elevators & Periosteals	401-404
Bone Curettes	405-407
Cartilage & Tendon Instruments.....	408-410
Rongeurs.....	411-414
Bone Cutting Forceps	415-416
Bone Saws	417-418

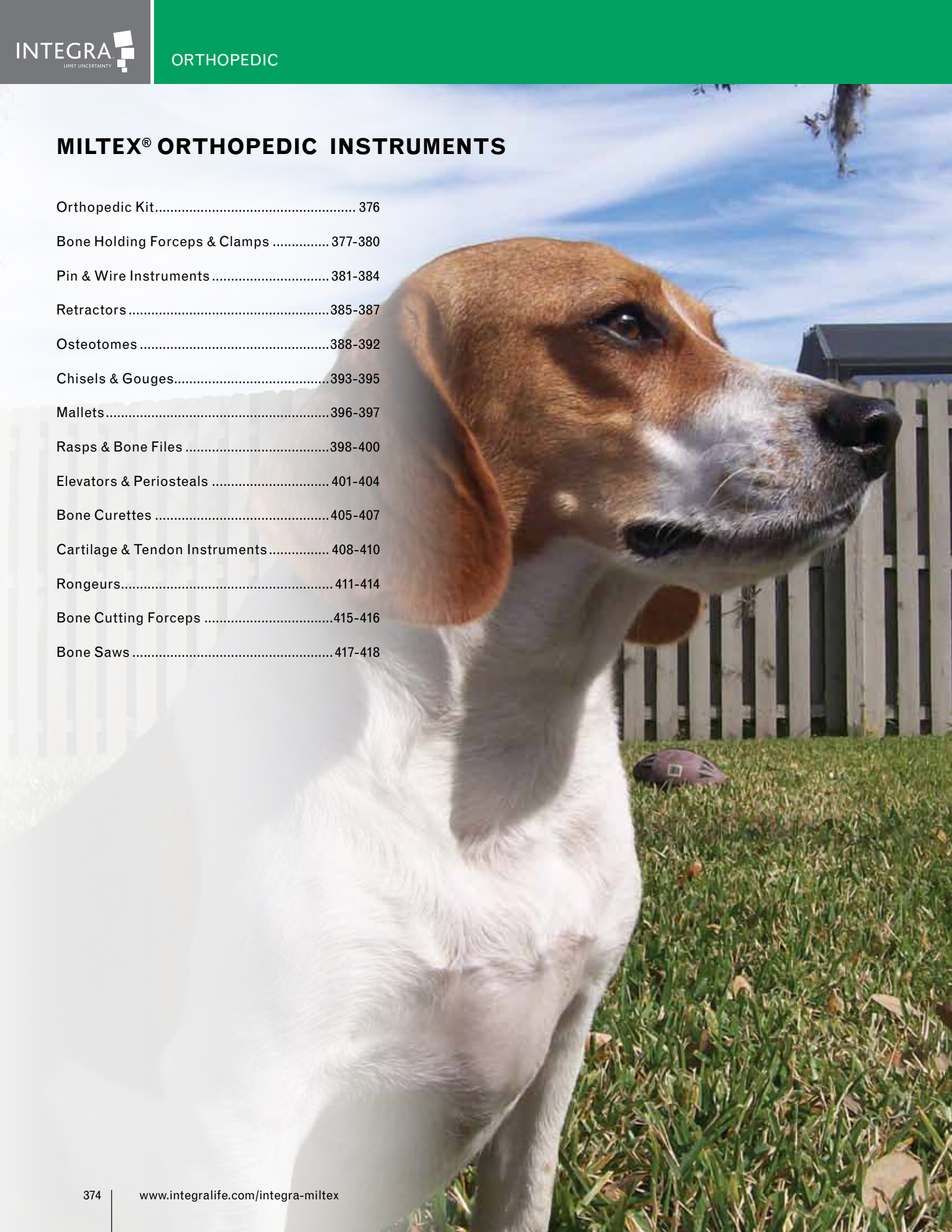

Clinician Spotlight

My Smallest Orthopedic Surgery Patient

As a zoo veterinarian, my patients range in size from miniscule to mammoth. Over the past 25 years, I've worked on everything from insects to elephants, but I will never forget my smallest orthopedic surgery patient, a recently fledged white-lined tanager (a small bird species native to Central and South America), 2 inches tall and weighing in at a whopping 25 grams!

"Sparky" had hatched in the Philadelphia Zoo's walk-through Jungle Bird Walk exhibit about 3 weeks earlier, and was being raised by her very attentive parents. She had been flying around the heavily planted aviary for a few days when the bird keepers routinely captured her to place a numbered plastic identification band on her leg. While placing the band, a keeper noticed fresh blood on the feathers under the left wing and called me immediately on my walkie-talkie.

Since any amount of blood loss from a bird that small can be a serious issue, I rushed across the Zoo to get a look at the wing. On the way there, I was hoping it was a simple problem, such as a broken blood feather that could be easily remedied by removing the damaged feather. Once I saw her wing though, I realized the Sparky had sustained an open fracture of her humerus and would require emergency surgery. She was transported back to the Zoo's Animal Health Center and anesthetized for further examination and treatment.

Radiographs confirmed an oblique fracture about two-thirds of the way down the humerus. Because my goal was to end up with a fully flighted bird, I was concerned that if the wing was simply splinted and bandaged, the fracture fragments might be poorly aligned and the fracture site might not be stable enough for proper healing. A humerus the diameter of a toothpick seemed unsuitable for an external fixator, but I recalled a picture from veterinary school of someone using a hypodermic needle as an IM pin in some other small creature, so decided to give that a try with Sparky.

By superimposing various needles on the preoperative radiograph, I chose a 1 inch 23 gauge needle as the IM pin. Holding the needle hub, I inserted the needle tip retrograde from the fracture site up through the proximal humeral fragment and out through the top of the shoulder. The needle hub was then clipped off at the fracture site, and the needle advanced normograde into the distal humeral fragment to the region of the elbow. Intraoperative radiographs showed the needle to be good position, so the remaining exteriorized portion of the needle at the shoulder was snipped off, the skin wounds sutured, and the wing splinted to the body.

Once a week, Sparky was re-anesthetized to change the wing bandage and check fracture healing. After 4 weeks, she was moved to a bigger completely enclosed cage, and the wing was left unbandaged so she could start exercising with the IM pin still providing some support. At 6 weeks post-surgery, the pin was finally removed and she continued improving her flying ability, and at 8 weeks was flying well enough to move to her own big exhibit.

The last time I saw Sparky was 2 years later when I did a pre-shipment physical exam prior to her leaving for another zoo. She was going to be paired with an unrelated male white-lined tanager in hopes that a future generation of tanagers would result. She looked (and flew) very well. I realized that having excellent orthopedic equipment is always a plus, but so is a little ingenuity and a great support staff!

By **Keith C. Hinshaw, DVM, MPVM**
Director, Department of Animal Health
Philadelphia Zoo, Philadelphia, Pennsylvania



Sparky chirping happily after undergoing orthopedic surgery

Orthopedic Kit

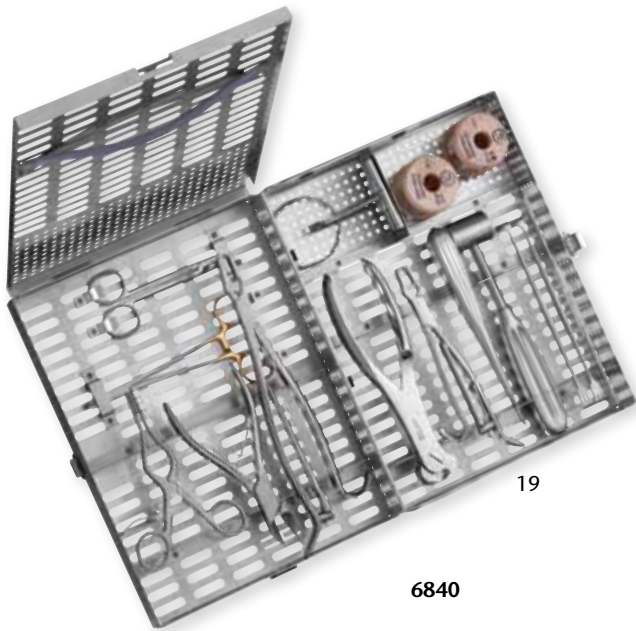

6840

REF# 6840 Orthopedic Kit Includes:

Qty.	REF	Description	
1	9-40-20	Suture Wire, 20 gauge	(1)
1	9-40-30	Suture Wire, 30 gauge	(2)
1	9-124	Wire Cutter	(3)
1	11-74	SENN Retractor, sharp	(4)
1	11-76	SENN Retractor, blunt	(5)
1	11-608	WEITLANER Retractor	(6)
1	18-1968	FREER Elevator	(7)
1	19-708	SPRATT Bone Curette	(8)
1	19-792	LUCAE Mallet	(9)
1	21-369	FOMAN Rasp	(10)
1	22-500TC	Wire Twister	(11)
2	26-120	GIGLI-STRULY Saw Handle	(12)
1	26-130	GIGLI-STRULY Saw	(13)
1	27-4	KERN Bone Holding Forceps, large	(14)
1	27-7	KERN Bone Holding Forceps, small	(15)
1	27-158	Pin Cutter	(16)
1	27-1390	LISTON Bone Cutting Forceps	(17)
1	27-603	Swiss Pattern Osteotomes	(18)
1	3-6845	Storage Cassette, 10-3/4" x 8-1/4" x 2-3/4"	(19)



Osteotome Kit

- 2 mm
- 4 mm
- 6 mm
- 8 mm
- 10 mm
- 12 mm
- 14 mm
- 18 mm
- 20 mm



27-610

REF# 27-610 Osteotome Kit includes:

Set of 9 SWISS Pattern Osteotomes 2 mm to 20 mm complete in customized storage cassette (10-1/2" x 8" x 1/2")

Bone Holding Forceps

REF	Description	Type	Length
27-2	KERN Bone Holding Forceps	standard size, plain	9-1/2" (24.1 cm)
27-4	KERN Bone Holding Forceps	standard size, with ratchet	9-1/2" (24.1 cm)
27-6	KERN Bone Holding Forceps	petite size, plain	6-3/4" (17.1 cm)
27-7	KERN Bone Holding Forceps	petite size, with ratchet	6-3/4" (17.1 cm)
27-14	FARABEUFLAMBOTTE Bone Holding Forceps	-	10-1/4" (26 cm)



27-2
27-6



27-4
27-7



27-14

Bone Holding Forceps

REF	Description	Type	Length
27-16	LEWIN Bone Holding Forceps	serrated jaws	7" (17.8 cm)
27-20	LANE Bone Holding Forceps	plain	13" (33 cm)
27-21	LANE Bone Holding Forceps	with ratchet	13" (33 cm)
27-22	LANE Bone Holding Forceps	plain	17" (43.2 cm)
27-23	LANE Bone Holding Forceps	with ratchet	17" (43.2 cm)



27-16



27-20
27-22



27-21
27-23

Bone Clamps & Forceps

REF	Description	Type	Length
7-510	ROEDER Clamp	with Ball Stops	5-1/4" (13.3 cm)
27-24	DINGMAN Small Bone & Cartilage Clamp	serrated jaws, 2 x 2 teeth, 4 mm wide	7-1/2" (19.1 cm)
27-30	LOWMAN Bone Clamp	calibrated in 1/8" (.32 cm), 1 x 2 prong jaws 3/4" (1.9 cm) wide	5" (12.7 cm)
27-32	LOWMAN Bone Clamp	calibrated in 1/8" (.32 cm), 1 x 2 prong jaws 1" (2.5 cm) wide	7" (17.8 cm)
27-34	LOWMAN Bone Clamp	calibrated in 1/8" (.32 cm), 1 x 2 prong jaws 1-1/4" (3.2 cm) wide	8" (20.3 cm)
27-42	LOWMAN-HOGLUND Bone Clamp	calibrated in 1/8" (.3 cm), 2 x 2 prong swivel jaws 1" (2.5 cm) wide	7" (17.8 cm)
27-44	LOWMAN-HOGLUND Bone Clamp	calibrated in 1/8" (.3 cm), 2 x 2 prong swivel jaws 1-3/8" (3.5 cm) wide	8" (20.3 cm)
27-46	LAMBERT-LOWMAN Bone Clamp	2 x 2 prong jaws 1" (2.5 cm) wide	7" (17.8 cm)
27-47	LAMBERT-LOWMAN Bone Clamp	2 x 2 prong jaws 1-3/8" (3.5 cm) wide	8" (20.3 cm)



7-510

27-24

27-30 to
27-34

27-42
27-44

27-46
27-47

Bone Clamps & Forceps

REF	Description	Type	Length
27-70	VERBRUGGE Bone Forceps	5 mm jaws	7" (17.8cm)
27-80	VERBRUGGE Bone Forceps	10 mm jaws	10" (25.4cm)
27-93	Bone Reduction Forceps	curved, with ratchet	5-1/2" (14cm)
27-95	Bone Reduction Forceps	curved, with ratchet	8" (20.3cm)
PM-3738*	BUNNELL Bone Holding Forceps	5 mm wide	7" (17.8 cm)
PM-405*	DINGMAN Bone Holding Clamp	heavy pattern with curved shanks	7-1/2" (19.1 cm)

* **PADGETT** INSTRUMENTS® By *Miltex*



27-70
27-80

27-95

27-93

PM-3738

PM-405

Pin & Wire Cutters & Twisters

REF	Description	Type	Length
9-128	Double Action Parallel Pliers & Wire Cutter	nickel plated	4-1/2" (11.4 cm)
27-158	MILTEX Cannulated Pin & Wire Cutter	end cutting up to 3.2 mm (1/8") soft wire or 1.6 mm (1/16") hard wire	7-1/2" (19.1 cm)
27-160	DIAMOND Pin & Wire Cutter	cuts up to 2 mm (5/64") diameter hard wire, stainless steel	6-1/2" (16.5 cm)
PM-4137*	MEADE Wire Cutting Pliers	tungsten carbide	9-1/2" (24 cm)
PM-2123*	CORWIN Wire Twister	tungsten carbide, serrated	6" (15.2 cm)
22-500TC	Wire Twister	with blunt Carb-N-Sert jaws	6" (15.2 cm)
22-502TC	Wire Twister	with blunt Carb-N-Sert jaws	8" (20.3 cm)

* **PADGETT** INSTRUMENTS By *Miltex*



9-128



27-158



27-160



PM-4137



PM-2123



22-500TC
22-502TC

Specialty Instruments for Pin & Wire

REF	Description	Jaws	Type	Length
27-159TC	Pin and Wire Cutter	double action, cuts up to 2 mm (5/64") soft wire or 1.5 mm (1/16") hard wire	Carb-N-Sert	7" (17.8 cm)
27-161TC	MILTEX Pin Cutter	heavy duty, double action, cuts up to 4.8 mm (3/16") diameter	Carb-N-Sert	15" (38.1 cm)
27-163TC	Front & Side Pin & Wire Cutter	double action, flush cutting, cuts up to 2 mm (5/64") soft wire or 1.6 mm (1/16") hard wire	Carb-N-Sert	7" (17.8 cm)
27-164TC	Pin & Wire Puller	4 mm wide jaws, double action	Carb-N-Sert	7" (17.8 cm)
27-165TC	Pin & Wire Puller	6 mm wide jaws, double action	Carb-N-Sert	7" (17.8 cm)
27-176TC	MILTEX Pin Puller	1 cm length serrated top jaw & 1 cm length grooved opposing jaw	Carb-N-Sert	5-1/2" (14 cm)



27-159TC



27-161TC



27-163TC



27-164TC



27-176TC

IM Pins

REF	Description
27-182	IM Pins, 1/16" x 7", double trocar, smooth
27-183	IM Pins, 5/64" x 7", double trocar, smooth
27-184	IM Pins, 3/32" x 8", double trocar, smooth
27-185	IM Pins, 7/64" x 8", double trocar, smooth
27-186	IM Pins, 1/8" x 9", double trocar, smooth
27-187	IM Pins, 9/64" x 9", double trocar, smooth
27-188	IM Pins, 5/32" x 10", double trocar, smooth
27-189	IM Pins, 3/16" x 12", double trocar, smooth
27-190	IM Pins, 1/4" x 12", double trocar, smooth



27-190

REF	Description
27-192	IM Pins, 1/16" x 7", double trocar, partial threaded
27-193	IM Pins, 5/64" x 7", double trocar, partial threaded
27-194	IM Pins, 3/32" x 8", double trocar, partial threaded
27-195	IM Pins, 7/64" x 8", double trocar, partial threaded
27-196	IM Pins, 1/8" x 9", double trocar, partial threaded
27-197	IM Pins, 9/64" x 9", double trocar, partial threaded
27-198	IM Pins, 5/32" x 10", double trocar, partial threaded
27-199	IM Pins, 3/16" x 12", double trocar, partial threaded
27-200	IM Pins, 1/4" x 12", double trocar, partial threaded



27-200

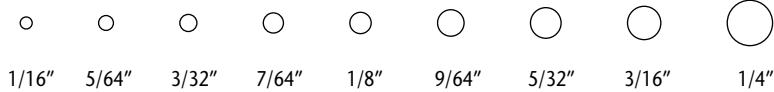

REF	Description
27-201	MILTEX Pin & Wire Gauge

side one
inches &
centimeters



side two
wire sizes



REF	Description	Type	Length
27-110	Bone Wire Guide	U.S. pattern	8-3/4" (22.2 cm)



27-110

Kirschner Wires

REF	Description	Type	Length
27-202	K-WIRE	trocac point with flat chuck end, .035"	12" (.9mm)
27-204	K-WIRE	trocac point with flat chuck end, .045"	12" (1.1mm)
27-206	K-WIRE	trocac point with flat chuck end, .0625"	12" (1.6mm),
27-208	K-WIRE	trocac point on both ends, .035"	7-1/2" (.9mm)
27-210	K-WIRE	trocac point on both ends, .045"	7-1/2" (1.1mm)
27-212	K-WIRE	trocac point on both ends, .0625"	7-1/2" (1.6mm)

◦
◦
◦
 .9 mm 1.1 mm 1.6 mm



27-202
tip detail
flat chuck end



27-202
tip detail
trocar point



27-206

BABCOCK Stainless Steel Suture Wire

REF	1 oz.(28 g) spool	Gauge	Diameter
9-40-18	13 ft.	18	.040" (1 mm)
9-40-20	20 ft.	20	.032" (.8 mm)
9-40-22	30 ft.	22	.025" (.6 mm)
9-40-24	45 ft.	24	.020" (.5 mm)
9-40-25	54 ft.	25	.018" (.45 mm)
9-40-26	72 ft.	26	.016" (.4 mm)
9-40-28	125 ft.	28	.012" (.3 mm)
9-40-30	180 ft.	30	.010" (.25 mm)
9-40-32	295 ft.	32	.008" (.2 mm)
9-40-34	500 ft.	34	.006" (.15 mm)
9-40-36	750 ft.	36	.005" (.13 mm)



9-40-24

REF	4 oz. (113 g) spool	Gauge	Diameter
9-44-18	48 ft.	18	.040" (1 mm)
9-44-20	75 ft.	20	.032" (.8 mm)
9-44-22	120 ft.	22	.025" (.6 mm)
9-44-24	184 ft.	24	.020" (.5 mm)
9-44-25	214 ft.	25	.018" (.45 mm)
9-44-26	285 ft.	26	.016" (.4 mm)
9-44-28	500 ft.	28	.012" (.3 mm)
9-44-30	675 ft.	30	.010" (.25 mm)
9-44-32	1200 ft.	32	.008" (.2 mm)
9-44-34	2030 ft.	34	.006" (.15 mm)



9-44-24

Retractors & Hooks

REF	Description	Type	Length
11-500	VOLKMAN Hook	sharp, hollow handle	8-1/2" (21.6 cm)
11-502	VOLKMAN Hook	sharp, ring handle	8-1/2" (21.6 cm)
26-2000	INGE Laminectomy spreader	jaws open to 1-1/8" (2.8 cm)	6" (15.2 cm)
26-2005	INGE Laminectomy spreader	jaws open to 1-3/4" (4.4 cm)	9-1/2" (24.1 cm)
27-224	SMILLIE Meniscus Hook Retractor	blade 3/4" x 1-3/8" (1.9 cm x 3.5 cm)	5-3/4" (14.6 cm)
27-225	HAYS Hand & Finger Retractor	angled blade 1-1/2" (3.8 cm) long, tapering width 3/8" to 1/8" (1 cm to .32 cm)	6" (15.2 cm)
27-230	VOLKMAN Hook Retractor	sharp point 15 mm deep	9" (22.9 cm)
27-232	VOLKMAN Hook Retractor	blunt tip 15 mm deep	9" (22.9 cm)

Please refer to page 136 to see more Miltex® retractors



11-500 11-502

26-2000
26-2005

27-224

27-225

27-230

27-232

Hand Held Retractors

REF	Description	Type	Length
11-350	ISRAEL Retractor	blunt, 4 prongs, 1-3/4" x 1-5/8" (4.4 cm x 4.2 cm)	9-3/4" (24.8 cm)
11-352	ISRAEL Retractor	blunt, 6 prongs, 2-3/8" x 1-3/4" (6.0 cm x 4.4 cm)	10" (25.4 cm)
27-213	MINI-HOHMANN Retractor	blade 6 mm wide	6-1/4" (15.9 cm)
27-214	MINI-HOHMANN Retractor	blade 8 mm wide	6-1/4" (15.9 cm)
27-215	HOHMANN Retractor	blade 10 mm wide	9-1/4" (23.5 cm)
27-216	HOHMANN Retractor	blade 18 mm wide	9-1/4" (23.5 cm)
27-217	HOHMANN Retractor	blade 25 mm wide	9-1/4" (23.5 cm)
27-218	HOHMANN Retractor	blade 43 mm wide	9-1/4" (23.5 cm)
27-219	HOHMANN Retractor	blade 70 mm wide	9-3/4" (24.8 cm)



11-350



11-352



27-213 to
27-214



27-215 to
27-217



27-218 to
27-219

Hand Held Retractors

REF	Description	Type	Length
11-504	VOLKMAN Retractor	2 prongs, sharp, hollow handle	8-1/2" (21.6 cm)
11-506	VOLKMAN Retractor	3 prongs, sharp, hollow handle	8-1/2" (21.6 cm)
11-508	VOLKMAN Retractor	4 prongs, sharp, hollow handle	8-1/2" (21.6 cm)
11-512	VOLKMAN Retractor	2 prongs, blunt, hollow handle	8-1/2" (21.6 cm)
11-514	VOLKMAN Retractor	3 prongs, blunt, hollow handle	8-1/2" (21.6 cm)
11-516	VOLKMAN Retractor	4 prongs, blunt, hollow handle	8-1/2" (21.6 cm)
11-530	VOLKMAN Retractor	2 prongs, sharp, ring handle	8-1/4" (21 cm)
11-532	VOLKMAN Retractor	3 prongs, sharp, ring handle	8-1/4" (21 cm)
11-534	VOLKMAN Retractor	4 prongs, sharp, ring handle	8-1/4" (21 cm)
11-536	VOLKMAN Retractor	6 prongs, sharp, ring handle	8-1/4" (21 cm)
11-538	VOLKMAN Retractor	2 prongs, blunt, ring handle	8-1/4" (21 cm)
11-540	VOLKMAN Retractor	3 prongs, blunt, ring handle	8-1/4" (21 cm)
11-542	VOLKMAN Retractor	4 prongs, blunt, ring handle	8-1/4" (21 cm)
11-544	VOLKMAN Retractor	6 prongs, blunt, ring handle	8-1/4" (21 cm)



11-504 to
11-516



11-530 to
11-544

Osteotomes

Osteotomes must be routinely sharpened. Please see our Reference Section on page 544 for information on how to send your instruments to Miltex® for evaluation and sharpening.

REF	Description	Type	Length
27-270	U.S. ARMY Pattern Osteotome	6 mm wide	6-1/2" (16.5 cm)
27-272	U.S. ARMY Pattern Osteotome	12 mm wide	6-1/2" (16.5 cm)
27-274	U.S. ARMY Pattern Osteotome	18 mm wide	6-1/2" (16.5 cm)
27-331	HOKE Osteotome	straight 1/8" (.32 cm)	5-1/2" (14 cm)
27-332	HOKE Osteotome	straight 3/16" (.48 cm)	5-1/2" (14 cm)
27-333	HOKE Osteotome	straight 1/4" (.64 cm)	5-1/2" (14 cm)
27-334	HOKE Osteotome	straight 5/16" (.79 cm)	5-1/2" (14 cm)
27-335	HOKE Osteotome	straight 3/8" (.95 cm)	5-1/2" (14 cm)
27-336	HOKE Osteotome	straight 1/2" (1.3 cm)	5-1/2" (14 cm)
27-599	SWISS Pattern Osteotome	2 mm wide	5" (12.7 cm)
27-600	SWISS Pattern Osteotome	4 mm wide	5" (12.7 cm)
27-601	SWISS Pattern Osteotome	6 mm wide	5" (12.7 cm)
27-601A	SWISS Pattern Osteotome	8 mm wide	5" (12.7 cm)
27-602	SWISS Pattern Osteotome	10 mm wide	5" (12.7 cm)
27-602A	SWISS Pattern Osteotome	12 mm wide	5" (12.7 cm)
27-603	SWISS Pattern Osteotome	14 mm wide	5" (12.7 cm)
27-604	SWISS Pattern Osteotome	18 mm wide	5" (12.7 cm)
27-605	SWISS Pattern Osteotome	20 mm wide	5" (12.7 cm)
27-609	Storage Case	5-1/2" (14 cm) x 6-1/2" (16.5 cm) x 1/2" (1.3cm)	fitted to hold 9 SWISS Pattern Osteotomes 2 to 20 mm
27-610	Set of 9 SWISS Pattern Osteotomes	2 mm to 20 mm, complete with storage case	



27-270 to
27-274

27-331 to
27-336



- 2 mm
- 4 mm
- 6 mm
- 8 mm
- 10 mm
- 12 mm
- 14 mm
- 18 mm
- 20 mm

27-599 to
27-610

Lambotte Osteotomes

REF	Description	Type	Length
27-488	LAMBOTTE Osteotome	straight, 6 mm (1/4")	9" (22.9 cm)
27-490	LAMBOTTE Osteotome	straight, 13 mm (1/2")	9" (22.9 cm)
27-492	LAMBOTTE Osteotome	straight, 19 mm (3/4")	9" (22.9 cm)
27-494	LAMBOTTE Osteotome	straight, 25 mm (1")	9" (22.9 cm)
27-496	LAMBOTTE Osteotome	straight, 32 mm (1-1/4")	9" (22.9 cm)
27-498	LAMBOTTE Osteotome	straight, 38 mm (1-1/2")	9" (22.9 cm)
27-499	LAMBOTTE Osteotome	curved, 6 mm (1/4")	9" (22.9 cm)
27-500	LAMBOTTE Osteotome	curved, 13 mm (1/2")	9" (22.9 cm)
27-502	LAMBOTTE Osteotome	curved, 19 mm (3/4")	9" (22.9 cm)
27-504	LAMBOTTE Osteotome	curved, 25 mm (1")	9" (22.9 cm)
27-506	LAMBOTTE Osteotome	curved, 32 mm (1-1/4")	9" (22.9 cm)
27-508	LAMBOTTE Osteotome	curved, 38 mm (1-1/2")	9" (22.9 cm)



27-488



27-499

Smith-Peterson Osteotomes

REF	Description	Type	Length
27-510	SMITH-PETERSON Osteotome	straight, 1/4" (.64 cm)	8" (20.3 cm)
27-512	SMITH-PETERSON Osteotome	straight, 3/8" (.95 cm)	8" (20.3 cm)
27-514	SMITH-PETERSON Osteotome	straight, 1/2" (1.3 cm)	8" (20.3 cm)
27-516	SMITH-PETERSON Osteotome	straight, 5/8" (1.6 cm)	8" (20.3 cm)
27-518	SMITH-PETERSON Osteotome	straight, 3/4" (1.9 cm)	8" (20.3 cm)
27-520	SMITH-PETERSON Osteotome	straight, 1" (2.5 cm)	8" (20.3 cm)
27-522	SMITH-PETERSON Osteotome	straight, 1-1/4" (3.2 cm)	8" (20.3 cm)
27-530	SMITH-PETERSON Osteotome	curved, 1/4" (.64 cm)	8" (20.3 cm)
27-532	SMITH-PETERSON Osteotome	curved, 3/8" (.95 cm)	8" (20.3 cm)
27-534	SMITH-PETERSON Osteotome	curved, 1/2" (1.3 cm)	8" (20.3 cm)
27-536	SMITH-PETERSON Osteotome	curved, 5/8" (1.6 cm)	8" (20.3 cm)
27-538	SMITH-PETERSON Osteotome	curved, 3/4" (1.9 cm)	8" (20.3 cm)
27-540	SMITH-PETERSON Osteotome	curved 1" (2.5 cm)	8" (20.3 cm)
27-542	SMITH-PETERSON Osteotome	curved, 1-1/4" (3.2 cm)	8" (20.3 cm)



27-510



27-540

Hibbs Osteotomes

REF	Description	Type	Length
27-438	HIBBS Osteotome	straight, 1/4" (.64 cm)	9-1/2" (24.1 cm)
27-440	HIBBS Osteotome	straight, 3/8" (0.95 cm)	9-1/2" (24.1 cm)
27-442	HIBBS Osteotome	straight, 1/2" (1.3 cm)	9-1/2" (24.1 cm)
27-444	HIBBS Osteotome	straight, 5/8" (1.6 cm)	9-1/2" (24.1 cm)
27-446	HIBBS Osteotome	straight, 3/4" (1.9 cm)	9-1/2" (24.1 cm)
27-447	HIBBS Osteotome	straight, 7/8" (2.2 cm)	9-1/2" (24.1 cm)
27-448	HIBBS Osteotome	straight, 1" (2.5 cm)	9-1/2" (24.1 cm)
27-449	HIBBS Osteotome	straight, 1-1/8" (2.8 cm)	9-1/2" (24.1 cm)
27-450	HIBBS Osteotome	straight, 1-1/4" (3.2 cm)	9-1/2" (24.1 cm)
27-452	HIBBS Osteotome	straight, 1-1/2" (3.8 cm)	9-1/2" (24.1 cm)
27-438C	HIBBS Osteotome	curved, 1/4" (.64 cm)	9-1/2" (24.1 cm)
27-440C	HIBBS Osteotome	curved, 3/8" (0.95 cm)	9-1/2" (24.1 cm)
27-442C	HIBBS Osteotome	curved, 1/2" (1.3 cm)	9-1/2" (24.1 cm)
27-444C	HIBBS Osteotome	curved, 5/8" (1.6 cm)	9-1/2" (24.1 cm)
27-446C	HIBBS Osteotome	curved, 3/4" (1.9 cm)	9-1/2" (24.1 cm)
27-447C	HIBBS Osteotome	curved, 7/8" (2.2 cm)	9-1/2" (24.1 cm)
27-448C	HIBBS Osteotome	curved, 1" (2.5 cm)	9-1/2" (24.1 cm)
27-449C	HIBBS Osteotome	curved, 1-1/8" (2.8 cm)	9-1/2" (24.1 cm)
27-450C	HIBBS Osteotome	curved, 1-1/4" (3.2 cm)	9-1/2" (24.1 cm)
27-452C	HIBBS Osteotome	curved, 1-1/2" (3.8 cm)	9-1/2" (24.1 cm)



27-438 tp
27-452

27-438C to
27-452C

Osteotomes

REF	Description
62-100	Osteotome, Sharp, 2 mm
62-101	Osteotome, Sharp, 2.7 mm
62-102	Osteotome, Sharp, 3.25 mm
62-103	Osteotome, Sharp, 3.8 mm
62-104	Osteotome, Blunt, 3 mm
62-105	Osteotome, Blunt, 4 mm
62-106	Osteotome, Blunt, 5 mm

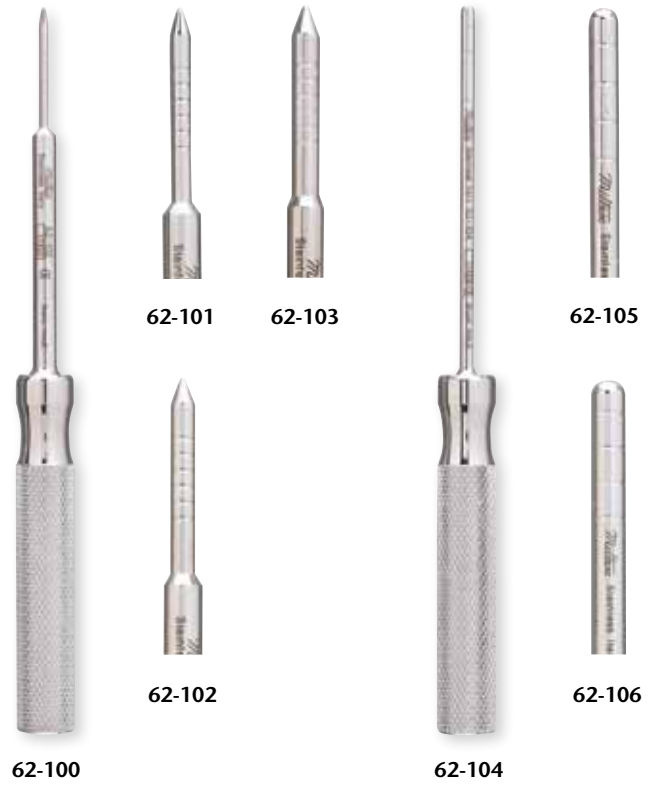

Progressive Osteotomes

REF	Description
62-120	Osteotome, Progressive, Concave, 1.6 mm
62-121	Osteotome, Progressive, Concave, 1.9 mm
62-122	Osteotome, Progressive, Concave, 2.8 mm
62-123	Osteotome, Progressive, Concave, 3.1 mm
62-124	Osteotome, Progressive, Concave, 3.9 mm
62-125	Osteotome, Progressive, Concave, 5.5 mm



PADGETT Mini Osteotomes

REF	Description	Type	Length	Width
PM-044402	Mini Osteotome	straight	5" (12.7 cm)	2 mm
PM-044404	Mini Osteotome	straight	5" (12.7 cm)	4 mm
PM-044406	Mini Osteotome	straight	5" (12.7 cm)	6 mm
PM-044408	Mini Osteotome	straight	5" (12.7 cm)	8 mm
PM-044410	Mini Osteotome	straight	5" (12.7 cm)	10 mm
PM-044412	Mini Osteotome	straight	5" (12.7 cm)	12 mm
PM-044422	Mini Osteotome	curved	5" (12.7 cm)	2 mm
PM-044424	Mini Osteotome	curved	5" (12.7 cm)	4 mm
PM-044426	Mini Osteotome	curved	5" (12.7 cm)	6 mm
PM-044428	Mini Osteotome	curved	5" (12.7 cm)	8 mm
PM-044430	Mini Osteotome	curved	5" (12.7 cm)	10 mm
PM-044432	Mini Osteotome	curved	5" (12.7 cm)	12 mm

*Distal working end serrated for bone compacting and mallet interface control

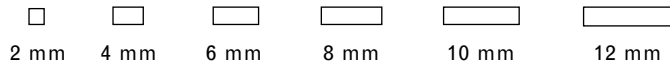

PM-044402

PM-044422

Graduated Chisels

Graduated chisels are used to widen ridges and feature reference graduation marks. These chisels are available in straight and curved patterns.

REF	Description
62-20	Chisel, Graduated, Straight, 3.8mm (7-10-13-15-18 mm markings)
62-21	Chisel, Graduated, Curved, 3.8mm (7-10-13-15-18 mm markings)
62-22	Chisel, Graduated, Straight, 7.5mm (7-10-13-15-18 mm markings)
62-23	Chisel, Graduated, Curved, 7.5mm (7-10-13-15-18 mm markings)



Freer Chisels

The extremely sharp tips of Freer chisels make it possible to incise and widen ridges. These chisels are available in single or double edge.

REF	Description
62-40	Chisel, Freer, Single Cut Blade, 2 mm
62-41	Chisel, Freer, Single Cut Blade, 4 mm
62-42	Chisel, Freer, Single Cut Blade, 6 mm
62-43	Chisel, Freer, Double Cut Blade, 2 mm
62-44	Chisel, Freer, Double Cut Blade, 4 mm
62-45	Chisel, Freer, Double Cut Blade, 6 mm



U.S. Army Pattern Chisels & Gouges

REF	Description	Type	Length
27-260	U.S. ARMY Pattern Chisel	6 mm wide	6-1/2" (16.5 cm)
27-262	U.S. ARMY Pattern Chisel	12 mm wide	6-1/2" (16.5 cm)
27-264	U.S. ARMY Pattern Chisel	18 mm wide	6-1/2" (16.5 cm)
27-280	U.S. ARMY Pattern Gouge	6 mm wide	6-1/2" (16.5 cm)
27-282	U.S. ARMY Pattern Gouge	12 mm wide	6-1/2" (16.5 cm)



27-260 to
27-264



27-280

Alexander Chisels & Gouges

REF	Description	Type	Length
19-750	ALEXANDER Chisel	4 mm width	7" (17.8 cm)
19-752	ALEXANDER Chisel	6 mm width	7" (17.8 cm)
19-754	ALEXANDER Chisel	8 mm width	7" (17.8 cm)
19-756	ALEXANDER Chisel	10 mm width	7" (17.8 cm)
19-758	ALEXANDER Chisel	12 mm width	7" (17.8 cm)
19-760	ALEXANDER Chisel	14 mm width	7" (17.8 cm)
19-770	ALEXANDER Gouge	4 mm width	7" (17.8 cm)
19-772	ALEXANDER Gouge	6 mm width	7" (17.8 cm)
19-774	ALEXANDER Gouge	8 mm width	7" (17.8 cm)
19-776	ALEXANDER Gouge	10 mm width	7" (17.8 cm)
19-778	ALEXANDER Gouge	12 mm width	7" (17.8 cm)
19-780	ALEXANDER Gouge	14 mm width	7" (17.8 cm)



19-750 to
19-758



19-770 to
19-780

Hibbs Chisels & Gouges

REF	Description	Type	Length
27-418	HIBBS Chisel	straight, 1/4" (.64 cm)	9-1/2" (24.1 cm)
27-420	HIBBS Chisel	straight, 3/8" (.95 cm)	9-1/2" (24.1 cm)
27-422	HIBBS Chisel	straight, 1/2" (1.3 cm)	9-1/2" (24.1 cm)
27-424	HIBBS Chisel	straight, 5/8" (1.6 cm)	9-1/2" (24.1 cm)
27-426	HIBBS Chisel	straight, 3/4" (1.9 cm)	9-1/2" (24.1 cm)
27-426C	HIBBS Chisel	curved, 3/4" (1.9 cm)	9-1/2" (24.1 cm)
27-427	HIBBS Chisel	straight, 7/8" (2.2 cm)	9-1/2" (24.1 cm)
27-428	HIBBS Chisel	straight, 1" (2.5 cm)	9-1/2" (24.1 cm)
27-432	HIBBS Chisel	straight, 1-1/2" (3.8 cm)	9-1/2" (24.1 cm)
27-458	HIBBS Gouge	straight, 1/4" (.64 cm)	9-3/4" (24.8 cm)
27-458C	HIBBS Gouge	curved, 1/4" (.64 cm)	9-3/4" (24.8 cm)
27-460	HIBBS Gouge	straight, 3/8" (.95 cm)	9-3/4" (24.8 cm)
27-460C	HIBBS Gouge	curved, 3/8" (.95 cm)	9-3/4" (24.8 cm)
27-462	HIBBS Gouge	straight, 1/2" (1.3 cm)	9-3/4" (24.8 cm)
27-462C	HIBBS Gouge	curved, 1/2" (1.3 cm)	9-3/4" (24.8 cm)
27-464C	HIBBS Gouge	curved, 5/8" (1.6 cm)	9-3/4" (24.8 cm)
27-466	HIBBS Gouge	straight, 3/4" (1.9 cm)	9-3/4" (24.8 cm)
27-466C	HIBBS Gouge	curved, 3/4" (1.9 cm)	9-3/4" (24.8 cm)
27-468	HIBBS Gouge	straight, 1" (2.5 cm)	9-3/4" (24.8 cm)



27-460

27-466C

Smith-Peterson Gouges

REF	Description	Type	Length
27-549	SMITH-PETERSON Gouge	straight, 1/4" (.64 cm)	8" (20.3 cm)
27-550	SMITH-PETERSON Gouge	straight, 3/8" (.95 cm)	8" (20.3 cm)
27-551	SMITH-PETERSON Gouge	straight, 1/2" (1.3 cm)	8" (20.3 cm)
27-553	SMITH-PETERSON Gouge	straight, 5/8" (1.6 cm)	8" (20.3 cm)
27-554	SMITH-PETERSON Gouge	straight, 3/4" (1.9 cm)	8" (20.3 cm)
27-556	SMITH-PETERSON Gouge	straight, 1" (2.5 cm)	8" (20.3 cm)
27-558	SMITH-PETERSON Gouge	straight, 1-1/4" (3.2 cm)	8" (20.3 cm)



27-553

Mallets

REF	Description	Type	Length
19-790	GERZOG Mallet	head 8 oz. (227 g) lead filled with stainless steel jacket	7-1/2" (19.1 cm)
19-792	LUCAE Mallet	head 9 oz. (255 g) solid stainless steel head 1" (2.5 cm) diameter	7-3/4" (19.7 cm)
19-793	MILTEX Mallet	lightweight 7.5 oz. (213 g), stainless steel head 1" (2.5 cm) diameter, with 2 replaceable nylon caps	7-1/2" (19.1 cm)
19-794	MILTEX Mallet	lightweight 9 oz. (255 g), stainless steel head 1" (2.5 cm) diameter, with one stainless steel face & one replaceable nylon cap	7-1/2" (19.1 cm)
19-795	Nylon Cap Replacement	fits 19-793 & 19-794 Mallets	-



19-790



19-792



19-793



19-794

Mallets

REF	Description	Type	Length
19-796	MEAD Mallet	head 8 oz. (227 g) with 2 replaceable nylon caps	7-1/2" (19.1 cm)
19-797	Nylon Cap Replacement	fits 19-796 Mallet	-
27-660	MILTEX Mallet	head 16 oz. (454 g) solid stainless steel	11" (27.9 cm)
27-662	MILTEX Mallet	head 32 oz. (908 g) solid stainless steel	11" (27.9 cm)
PM-805*	FOWLER Aluminum Mallet	head 10 oz. (284 g) 1-1/2" (38 mm) diameter	7-3/4" (19.7 cm)

*  **PADGETT**
INSTRUMENTS® By *Miltex*



19-796

27-660

27-662

PM-805

Rasps & Bone Files

REF	Description	Type	Length
21-360	GALLAHER Rasp	straight, coarse teeth	7-1/2" (19.1 cm)
21-368	FOMON Rasp	double ended, 4-sided, fine & coarse, flat & convex	8-1/4" (21 cm)
21-369	FOMON Rasp	double ended, coarse teeth, flat & convex	8-1/4" (21 cm)
21-370	FOMON Rasp	double ended, fine teeth, flat & convex	8-1/4" (21 cm)
27-700	PUTTI Bone Rasp	flat ends, one side curved on flat, other side curved sideways	10-1/2" (26.7 cm)
27-702	PUTTI Bone Rasp	round and half-round tapered curved ends	12" (30.5 cm)
27-703	Bone File	bayonet shank, half-round blade 3-1/2" (8.9 cm) x 1/2" (1.3 cm)	9-3/4" (24.8 cm)

Please refer to page 158 for more rasp and bone file patterns



21-360

21-368

21-369

21-370

27-700

27-702

27-703

Rasps & Bone Files

REF	Description	Style	Tip	Type	Length
21-392DC	PEET (COTTLE) Rasp	finishing rasp	straight	Diamond Coated	7-1/2" (19 cm)
21-393DC	PEET (COTTLE) Rasp	finishing rasp	curved	Diamond Coated	7-1/2" (19 cm)
21-394TC	GLABELLA Rasp	backward cutting	No. 3 Fine grit, 5.5 mm x 10 mm radius tip	Carb-N-Sert	8-1/4" (21 cm)



21-392DC

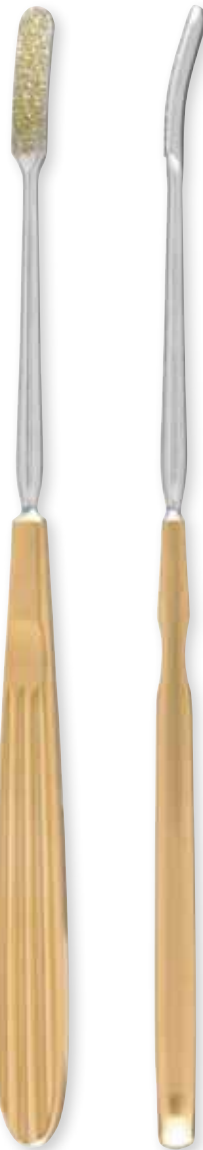

21-393DC



21-394TC

Bone Files

REF	Description	Type	Length
40-1370	Bone File	double end no. 10 pattern, plain serrations	7" (17.8 cm)
40-1371	Bone File	double end no. 33 pattern, plain serrations	7" (17.8 cm)
40-1375	Bone File (MILLER)	double end no. 64 pattern, plain serrations	7" (17.8 cm)
40-1380	Bone File (MILLER)	double end no. 45 pattern, plain serrations	7" (17.8 cm)
40-1381	Bone File (HOWARD)	double end no. 12 pattern, plain serrations	7" (17.8 cm)
40-1382	Bone File (HOWARD)	double end no. 12A pattern, one end plain, other end cross serrated	7" (17.8 cm)
40-1385	Bone File (HOWARD)	double end no. 12CA BELL pattern, cross serrations	7" (17.8 cm)
40-2800	POLOKOFF Bone File	double end, narrow pattern (POL-1)	7-1/4" (18.4 cm)



40-1370

40-1371

40-1375

40-1380

40-1381

40-1382

40-1385

40-2800

Elevators & Periosteals

REF	Description	Type	Length
18-1968	FREER Elevator	double end sharp and blunt blades, 5 mm wide	7" (17.8 cm)
20-230	PIERCE Double End Elevator	with right and left blades	8-1/2" (21.6 cm)
21-60	COTTLE Septum Elevator	double end, graduated in cm	9" (22.9 cm)
21-62	MCKENTY Elevator	curved tip, 4 mm wide	6" (15.2 cm)
21-63	MCKENTY Elevator	curved tip, 5 mm wide	6" (15.2 cm)
21-64	JOSEPH Periosteal Elevator	strong curve, 6.5 mm	7" (17.8 cm)
21-68	FOMON Periosteal Elevator	slightly curved blade, 4.5 mm wide, standard pattern	6-1/2" (16.5 cm)
21-72	COTTLE Skin Elevator	slightly curved blade, 9 mm wide	7-1/2" (19.1 cm)
25-28	SEDILLOT Periosteal Elevator	blade 17 mm wide	7-1/2" (19.1 cm)



18-1968

20-230

21-60

21-62

21-63

21-64

21-68

21-72

25-28

Periosteal Elevators

REF	Description	Type	Length
26-1410	LANGENBECK Periosteal Elevator	narrow model, 7 mm wide blunt blade	7-1/2" (19.1 cm)
26-1412	LANGENBECK Periosteal Elevator	wide model, 17 mm wide sharp blade	7-1/2" (19.1 cm)
26-1430	ADSON Periosteal Elevator	chisel edge, straight, 8mm wide	6-1/2" (16.5 cm)
26-1432	ADSON Periosteal Elevator	blunt, curved, 6 mm wide	6-1/2" (16.5 cm)
26-1434	ADSON Periosteal Elevator	semi-sharp, curved, 7 mm wide	6-1/2" (16.5 cm)
26-1436	ADSON Periosteal Elevator	semi-sharp, straight, 6 mm wide	6-1/2" (16.5 cm)
27-744	SAYRE Periosteal Elevator	one straight blunt & one curved sharp end	6-3/4" (17.1 cm)
27-746	SAYRE Periosteal Elevator	one straight blunt & one curved blunt end	6-3/4" (17.1 cm)



Periosteal Elevators

REF	Description	Type	Length
27-747	CHANDLER Bone Elevator	blade 1/2" (1.3 cm) tapering to 5/16" (.79 cm)	7-1/2" (19.1 cm)
27-748	CHANDLER Bone Elevator	blade 3/4" (1.9 cm) tapering to 1/2" (1.3 cm)	8" (20.3 cm)
27-749	CHANDLER Bone Elevator	blade 1" (2.5 cm) tapering to 11/16" (1.7 cm)	9-1/4" (23.5 cm)
27-750	CHANDLER Bone Elevator	blade 1-1/4" (3.2 cm) tapering to 3/4" (1.9 cm)	10" (25.4 cm)
27-752	CREGO Periosteal Elevator	slightly curved blade 7 mm	8" (20.3 cm)
27-753	CREGO Periosteal Elevator	fully curved blade 7 mm	8" (20.3 cm)
27-754	CREGO Periosteal Elevator	fully curved blade 14 mm	8" (20.3 cm)



Periosteal Elevators

REF	Description	Type	Length
27-820	KEY Periosteal Elevator	1/4" (.64 cm) wide	7" (17.8 cm)
27-821	KEY Periosteal Elevator	3/8" (.95 cm) wide	7-1/2" (19.1 cm)
27-822	KEY Periosteal Elevator	1/2" (1.3 cm) wide	7-1/2" (19.1 cm)
27-824	KEY Periosteal Elevator	3/4" (1.9 cm) wide	8" (20.3 cm)
27-826	KEY Periosteal Elevator	1" (2.5 cm) wide	8-1/4" (21 cm)
73-62	No. 7 Wax Spatula	-	-
73-64	No. 7A Wax Spatula	small end with one flat side	-
73-66	No. 7 Wax Spatula, long	-	-
73-78	No. 7 Cement Spatula	-	-
DELS23	SELDIN Periosteal Elevator	double end, slightly curved blades, 10 mm and 13 mm wide	7-3/4" (19.7 cm)



27-820

27-821

27-822

27-824 to
27-826

73-62

73-64

73-66

73-78

DELS23

Bone Curettes

REF	Description	Type	Length
19-721	COBB Curette	straight, oval cup, Size 3/0	11" (27.9cm)
19-722	COBB Curette	straight, oval cup, Size 2/0	11" (27.9cm)
19-723	COBB Curette	straight, oval cup, Size 0	11" (27.9cm)
19-724	COBB Curette	straight, oval cup, Size 1	11" (27.9cm)
19-725	COBB Curette	straight, oval cup, Size 2	11" (27.9cm)
19-726	COBB Curette	straight, oval cup, Size 3	11" (27.9cm)
19-727	COBB Curette	straight, oval cup, Size 4	11" (27.9cm)
19-728	COBB Curette	straight, oval cup, Size 5	11" (27.9cm)
19-729	COBB Curette	straight, oval cup, Size 6	11" (27.9cm)
<hr/>			
19-737	COBB Curette	angled, oval cup, Size 3/0	11" (27.9cm)
19-738	COBB Curette	angled, oval cup, Size 2/0	11" (27.9cm)
19-730	COBB Curette	angled, oval cup, Size 0	11" (27.9cm)
19-731	COBB Curette	angled, oval cup, Size 1	11" (27.9cm)
19-732	COBB Curette	angled, oval cup, Size 2	11" (27.9cm)
19-733	COBB Curette	angled, oval cup, Size 3	11" (27.9cm)
19-734	COBB Curette	angled, oval cup, Size 4	11" (27.9cm)
19-735	COBB Curette	angled, oval cup, Size 5	11" (27.9cm)
19-736	COBB Curette	angled, oval cup, Size 6	11" (27.9cm)
<hr/>			
26-1739	SPRATT Curette	angled, oval cup, Size 5/0	9" (22.9cm)
26-1738	SPRATT Curette	angled, oval cup, Size 4/0	9" (22.9cm)
26-1737	SPRATT Curette	angled, oval cup, Size 3/0	9" (22.9cm)
26-1728	SPRATT Curette	angled, oval cup, Size 00	9" (22.9cm)
26-1729	SPRATT Curette	angled, oval cup, Size 0	9" (22.9cm)
26-1730	SPRATT Curette	angled, oval cup, Size 1	9" (22.9cm)
26-1731	SPRATT Curette	angled, oval cup, Size 2	9" (22.9cm)
26-1732	SPRATT Curette	angled, oval cup, Size 3	9" (22.9cm)
26-1733	SPRATT Curette	angled, oval cup, Size 4	9" (22.9cm)
26-1734	SPRATT Curette	angled, oval cup, Size 5	9" (22.9cm)
26-1735	SPRATT Curette	angled, oval cup, Size 6	9" (22.9cm)

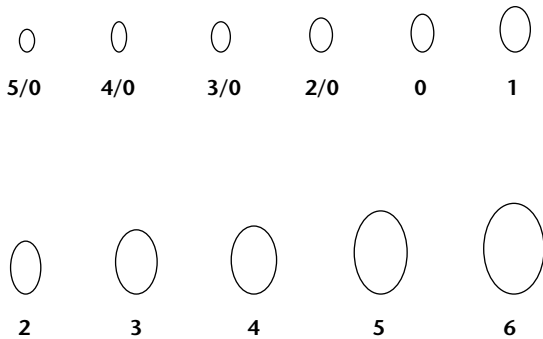

19-727

19-734

26-1729

Bone Curettes

REF	Description	Type	Length
19-700	SPRATT (Brun) Curette	oval cup, size 5/0	6-3/4" (17.1 cm)
19-702	SPRATT (Brun) Curette	oval cup, size 4/0	6-3/4" (17.1 cm)
19-704	SPRATT (Brun) Curette	oval cup, size 3/0	6-3/4" (17.1 cm)
19-706	SPRATT (Brun) Curette	oval cup, size 2/0	6-3/4" (17.1 cm)
19-708	SPRATT (Brun) Curette	oval cup, size 0	6-3/4" (17.1 cm)
19-710	SPRATT (Brun) Curette	oval cup, size 1	6-3/4" (17.1 cm)
19-712	SPRATT (Brun) Curette	oval cup, size 2	6-3/4" (17.1 cm)
19-714	SPRATT (Brun) Curette	oval cup, size 3	6-3/4" (17.1 cm)
19-716	SPRATT (Brun) Curette	oval cup, size 4	6-3/4" (17.1 cm)
19-718	SPRATT (Brun) Curette	oval cup, size 5	6-3/4" (17.1 cm)
19-720	SPRATT (Brun) Curette	oval cup, size 6	6-3/4" (17.1 cm)
26-1627	HIBBS SPRATT Spinal Fusion Curette	oval cup, size 3/0	9" (22.9 cm)
26-1628	HIBBS SPRATT Spinal Fusion Curette	oval cup, size 2/0	9" (22.9 cm)
26-1629	HIBBS SPRATT Spinal Fusion Curette	oval cup, size 0	9" (22.9 cm)
26-1630	HIBBS SPRATT Spinal Fusion Curette	oval cup, size 1	9" (22.9 cm)
26-1632	HIBBS SPRATT Spinal Fusion Curette	oval cup, size 2	9" (22.9 cm)
26-1634	HIBBS SPRATT Spinal Fusion Curette	oval cup, size 3	9" (22.9 cm)
26-1636	HIBBS SPRATT Spinal Fusion Curette	oval cup, size 4	9" (22.9 cm)
26-1638	HIBBS SPRATT Spinal Fusion Curette	oval cup, size 5	9" (22.9 cm)
26-1640	HIBBS SPRATT Spinal Fusion Curette	oval cup, size 6	9" (22.9 cm)

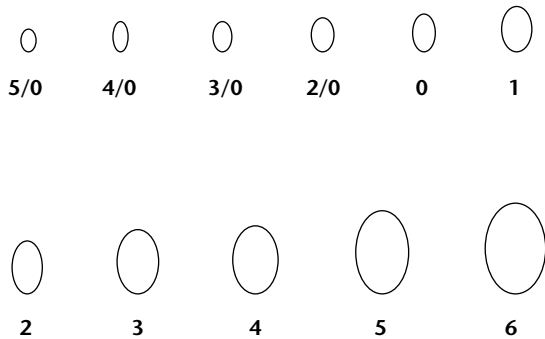

19-700 to
19-720

26-1627 to
26-1640

Bone Curettes

REF	Description	Type	Length
21-321	MARTINI Bone Curette	double ended, 4 mm & 5 mm round cups	5-1/2" (14 cm)
21-322	WILLIGER Bone Curette	double ended, 3 mm & 4 mm oval cups	5-1/2" (14 cm)
26-1650	BRUN Bone Curette	round cup, size 1, 7 mm	6-3/4" (17.1 cm)
26-1652	BRUN Bone Curette	round cup, size 2, 8 mm	6-3/4" (17.1 cm)
26-1654	BRUN Bone Curette	round cup, size 3, 9 mm	6-3/4" (17.1 cm)
26-1656	BRUN Bone Curette	round cup, size 4, 11 mm	6-3/4" (17.1 cm)
26-1658	BRUN Bone Curette	round cup, size 5, 12 mm	6-3/4" (17.1 cm)
26-1660	BRUN Bone Curette	round cup, size 6, 14 mm	6-3/4" (17.1 cm)
27-83	HATT Spoon	10 mm oval cup	9" (22.9cm)
27-84	HATT Spoon	15 mm oval cup	9" (22.9cm)
27-85	HATT Spoon	20 mm oval cup	9" (22.9cm)
27-920	VOLKMAN Double Ended Curette	long, oval cup 5 x 10 mm & 6 x 20 mm	5-1/2" (14 cm)
27-924	VOLKMAN Double Ended Curette	long, oval cup 6 x 10 mm & round cup 10 mm diameter	5" (12.7 cm)
27-926	VOLKMAN Double Ended Curette	long, oval cup 8 x 14 mm & round cup 10 mm diameter	6-1/2" (16.5 cm)
27-928	VOLKMAN Double Ended Curette	long, oval cup 9 x 18 mm & round cup 11 mm diameter	8" (20.3 cm)

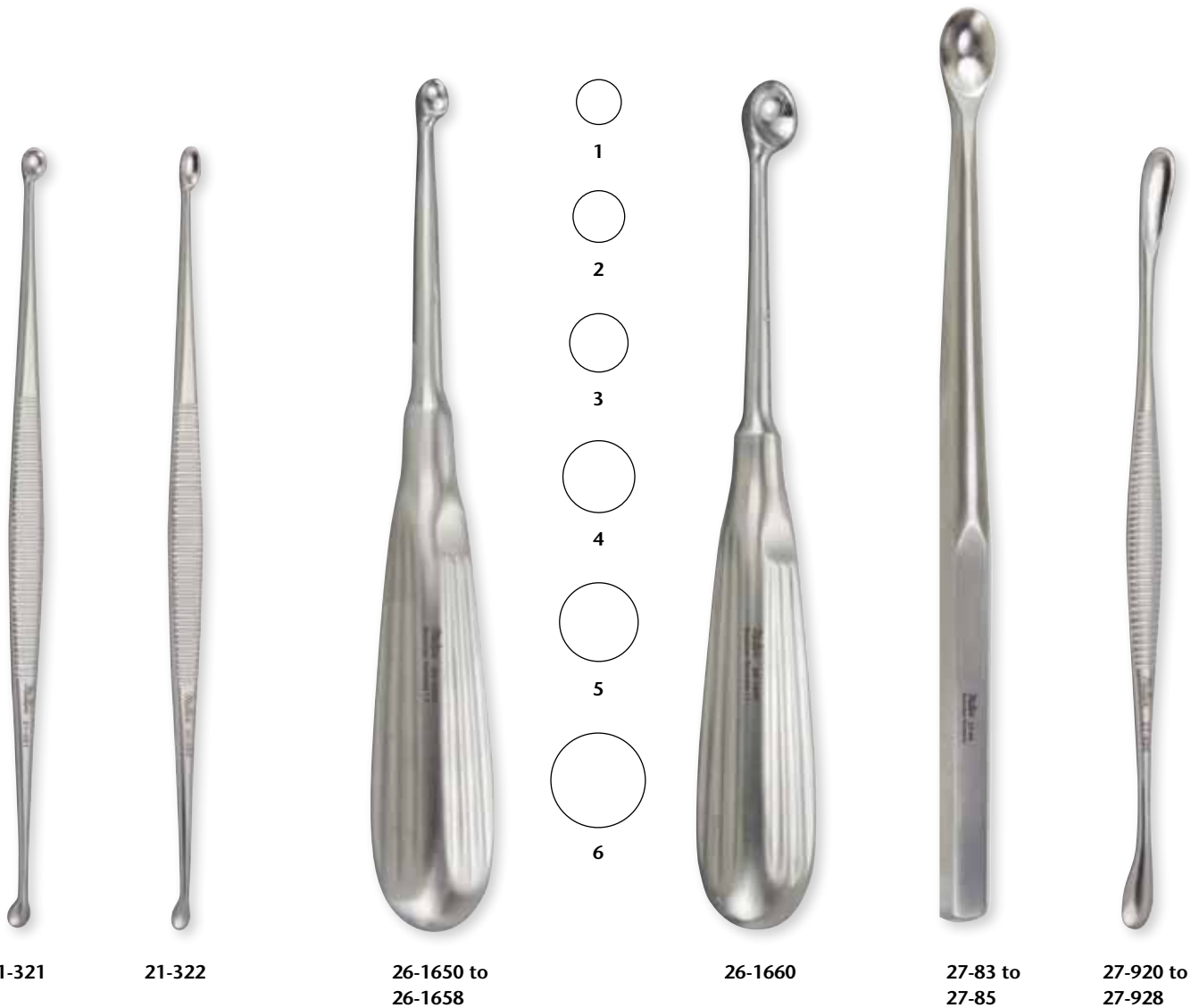

Cartilage & Tendon Instruments

REF	Description	Type	Length
27-970	SMILLIE Meniscus Knife	straight chisel blade	7-1/4" (18.4 cm)
27-972	SMILLIE Meniscus Knife	curved left	7" (17.8 cm)
27-974	SMILLIE Meniscus Knife	curved right	7" (17.8 cm)
27-980	LOWE-BRECK Cartilage Knife	straight edge with guards	10-1/2" (26.7 cm)
27-984	DOWNING Cartilage Knife	concave edge with guards	10" (25.4 cm)
27-990	MARTIN Cartilage Clamp	-	7" (17.8 cm)
27-992	MARTIN Cartilage Clamp	-	8" (20.3 cm)



Cartilage & Tendon Instruments

REF	Description	Type	Length
27-1000	MARTIN Cartilage Scissors	serrated non-slip cutting edges	8" (20.3 cm)
27-1016	MILTEX Tendon Pulling Forceps	curved shaft, alligator type	5" (12.7 cm)
40-1800	LOCKE Phalangeal Clamp	-	6" (15.2 cm)
40-1802	ROSENBLUM Sesamoidectomy Clamp	-	7" (17.8 cm)



22-1000



27-1016



40-1800



40-1802

Cartilage & Tendon Instruments

REF	Description	Type	Length
PM-2211	GUNTER Lower Lateral Morselizer	tungsten carbide jaws with semi-sharp longitudinal ridges	7" (17.8 cm)
PM-2215	GORNEY Septal Morselizer	tungsten carbide jaws, 1- serrated with pyramid shaped teeth & 1- with semi-sharp longitudinal ridges, double action, angled handles, with smooth clip	8-1/2" (21.6 cm)
PM-2216	GUNTER Lower Lateral Morselizer	tungsten carbide serrated jaws, 1- smooth & 1- serrated with pyramid shaped teeth	7" (17.8 cm)
PM-3819	Lower Lateral Cartilage Morselizer	1- smooth jaw and 1- serrated jaw with pyramid-shaped teeth, 4.3 mm x 9.5 mm	7-1/2" (19.1 cm)
PM-3830	PADGETT-RUBIN Morselizer	serrated long jaws with pyramid shaped teeth, double action, angled handles, with clip, 16 mm x 5 mm	8-1/4" (21 cm)
PM-3831	Replacement Slip On Clip	fits PADGETT-RUBIN Morselizer PM-3830	-

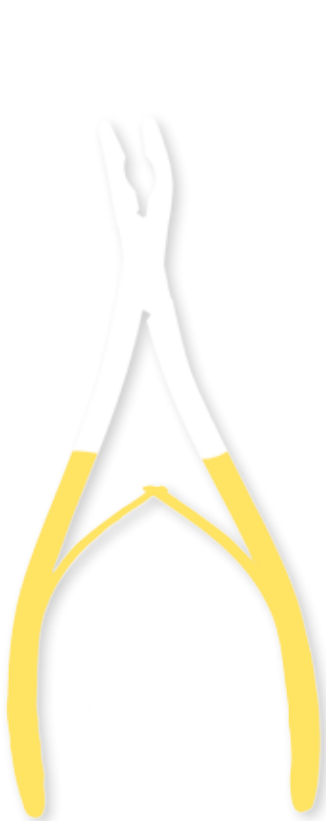

PM-2211
PM-2216



PM-2215



PM-3819



PM-3830

Rongeurs

REF	Description	Type	Length
19-804	HARTMAN Rongeur	strong curve, 4 x 12 mm bite	5-3/4" (14.6 cm)
19-808	BANE Rongeur	slight curve, 5 x 15 mm bite tapered to 7 mm	7" (17.8 cm)
22-480	DEAN (BLUMENTHAL) Rongeur	jaws at 30° angle, 3 x 10 mm bite tapered to 4 mm	6" (15.2 cm)
22-481	BLUMENTHAL Oral Surgery Rongeur	jaws at 30° angle, 3 x 8 mm bite tapered to 4 mm	7" (17.8 cm)
22-482	DEAN (BLUMENTHAL) Oral Surgery Rongeur	jaws at 90° angle, 3 x 10 mm bite tapered to 4 mm	6" (15.2 cm)
22-484	MEAD Rongeur	slightly angled jaws, 4 x 12 mm bite	6-1/2" (16.5 cm)
22D-420	BLUMENTHAL Rongeur	jaws at 45° angle, 3 x 12 mm bite	6" (15.2 cm)
26-190	LUER Rongeur	straight jaws, 8 mm bite	7" (17.8 cm)
26-192	LUER Rongeur	curved jaws, 8 mm bite	7" (17.8 cm)



19-804



19-808



22-482

22-480
22-481



22-484



22D-420



26-192

26-190

Rongeurs

REF	Description	Type	Length
27-1295	KLEINERT-KUTZ Rongeur	slightly curved jaws 2 x 13 mm	6" (15.2 cm)
27-1297	KLEINERT-KUTZ Synovectomy Rongeur	full curved jaws 3 x 8 mm	6" (15.2 cm)
19-840	ZAUFEL-JANSEN Rongeur	double action, slightly curved jaws 4 mm wide	7" (17.8 cm)
19-844	BEYER Rongeur	double action, slightly curved jaws 3 mm wide	7" (17.8 cm)
19-848	RUSKIN Rongeur	double action, straight, 3 mm bite jaws	6" (15.2 cm)
19-849	RUSKIN Rongeur	double action, curved, 3 mm bite jaws	6" (15.2 cm)
19-850	RUSKIN Rongeur	double action, straight, 5 mm bite jaws	7-1/4" (18.4 cm)
19-852	RUSKIN Rongeur	double action, curved, 5 mm bite jaws	7-1/4" (18.4 cm)
19-854	RUSKIN Rongeur	double action, straight, 7 mm bite jaws	7-1/4" (18.4 cm)
19-856	RUSKIN Rongeur	double action, curved, 7 mm bite jaws	7-1/4" (18.4 cm)



27-1295
27-1297



19-840



19-844



19-848 to
19-856

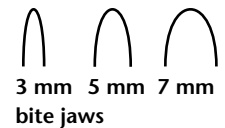

19-849
19-852
19-856

Rongeurs

REF	Description	Type	Length
25-454	STILLE-LUER Rongeur	straight jaws 9 x 15 mm	8-3/4" (22.2 cm)
25-456	STILLE-LUER Rongeur	curved jaws 9 x 15 mm	8-3/4" (22.2 cm)
25-458	STILLE-LUER Duckbill Rongeur	angled on side jaws 6 x 12 mm	9" (22.9 cm)
25-510	LEKSELL Laminectomy Rongeur	standard curve, 3 mm bite jaws	9-3/4" (24.8 cm)
25-511	LEKSELL Laminectomy Rongeur	standard curve, 8 mm bite jaws	9-3/4" (24.8 cm)
26-264	ECHLIN Duckbill Rongeur	2 mm bite	9" (22.9 cm)
26-265	ECHLIN Duckbill Rongeur	3 mm bite	9" (22.9 cm)
26-266	ECHLIN Duckbill Rongeur	4 mm bite	9" (22.9 cm)



25-454



25-456



25-458



25-510
25-511



26-264
26-265



26-266

Rongeurs

REF	Description	Type	Length
17-4800	Micro FRIEDMAN Rongeur	straight, 1.3 mm wide jaws, very delicate	5-1/2" (14 cm)
17-4801	Micro FRIEDMAN Rongeur	curved, 1.3 mm wide jaws, very delicate	5-1/2" (14 cm)
17D-4802	Micro FRIEDMAN Rongeur	90° angle, 1.3 mm wide jaws, very delicate	5-1/2" (14 cm)
18-1990	KERRISON Rongeur	size 0, 3.5 mm bite	3" (7.6 cm)
18-1992	KERRISON Rongeur	size 1, 4.0 mm bite	3" (7.6 cm)
18-1994	KERRISON Rongeur	size 2, 4.5 mm bite	3" (7.6 cm)
18-1996	KERRISON Rongeur	size 3, 5.0 mm bite	3" (7.6 cm)
19-1230	LEMPERT Rongeur	straight, 2.5 mm bite, delicate	6-1/4" (15.9 cm)
19-1232	LEMPERT Rongeur	curved, 2.5 mm bite, delicate	6-1/4" (15.9 cm)



17-4800



17-4801



17D-4802



18-1990 to
18-1996



19-1230
19-1232

Bone Cutting Forceps

REF	Description	Type	Length
21-626	RUSKIN Bone Cutting Forceps	straight, standard blades	5-3/4" (14.6 cm)
21-627	RUSKIN Bone Cutting Forceps	angled, standard blades	5-3/4" (14.6 cm)
21-628	RUSKIN Bone Cutting Forceps	straight, delicate blades	7-1/2" (19.1 cm)
25-384	RUSKIN Bone Cutting Forceps	straight, standard blades	7-1/2" (19.1 cm)
25-385	RUSKIN Bone Cutting Forceps	angled, standard blades	7-1/2" (19.1 cm)



21-626
21-627



21-628



25-384



25-385

Bone Cutting Forceps

REF	Description	Type	Length
25-390	STILLE-LISTON Bone Cutting Forceps	straight	10-3/4" (27.3 cm)
25-392	STILLE-LISTON Bone Cutting Forceps	curved	10-3/4" (27.3 cm)
25-396	STILLE-HORSLEY Bone Cutting Forceps	angled blades	10-1/2" (26.7 cm)
27-1390	LISTON Bone Cutting Forceps	straight	5-1/2" (14 cm)
27-1392	LISTON Bone Cutting Forceps	straight	7-1/2" (19.1 cm)
27-1394	LISTON Bone Cutting Forceps	straight	8-1/2" (21.6 cm)
27-1400	LISTON Bone Cutting Forceps	angled on flat	5-1/2" (14 cm)
27-1402	LISTON Bone Cutting Forceps	angled on flat	7-1/2" (19.1 cm)
27-1404	LISTON Bone Cutting Forceps	angled on flat	8-1/2" (21.6 cm)



25-390



25-392



25-396



27-1390



27-1392
27-1394



27-1400 to
27-1404

Bone Saws

REF	Description	Type	Length
26-119	GIGLI Saw Handle	standard pattern, T-shaped, turnable	-
26-120	GIGLI-STRULLY Saw Handle	T-shaped, rigid with snap lock	-
26-122	GIGLI-STRULLY Saw Handle	T-shaped, turnable, with snap lock	-
26-124	GIGLI-STRULLY Saw Handle	loop grip, rigid, with snap lock	-
26-130	GIGLI Saw	standard twisted wire type	12" (30.5 cm)
26-132	GIGLI Saw	standard twisted wire type	20" (50.8 cm)
26-134	GIGLI Saw	standard twisted wire type	30" (76.2 cm)
26-138	BAILEY-GIGLI Saw Guide	flexible	12" (30.5 cm)
26-140	MICHELE Trephine	3/16" (.47 cm) O.D. graduated 1/4" (.64 cm) to 1-1/4" (3.2 cm)	6-1/4" (15.9 cm) shaft
26-141	MICHELE Trephine	7/32" (.56 cm) O.D. graduated 1/4" (.64 cm) to 1-1/4" (3.2 cm)	6-1/4" (15.9 cm) shaft
26-142	MICHELE Trephine	5/16" (.79 cm) O.D. graduated 1/4" (.64 cm) to 1-1/4" (3.2 cm)	6-1/4" (15.9 cm) shaft
26-143	Marker for MICHELE Trephine	fits 26-142	-



26-119



26-120



26-124



26-130 to
26-134



26-138

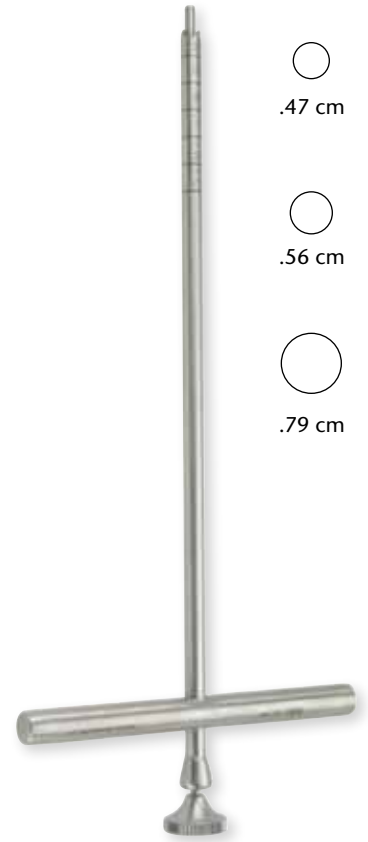

26-140 to
26-143

Bone Saws

REF	Description	Type	Length
27-1550	LANGENBECK Metacarpal Saw	blade 4-1/2" (11.4cm)	9-1/4" (23.5 cm)
27-1560	SATTERLEE Bone Saw	light metal handle with stainless steel 9" (22.9 cm) blade	12" (30.5 cm)
27-1561	Blade replacement	fits 27-1560 SATTERLEE Bone Saw	9" (22.9 cm)
27-1564	CHARRIERE Bone Saw	with one each 12 mm & 18 mm stainless steel blades	14" (35.6 cm)
27-1564-12	Blade replacement	fits 27-1564 CHARRIERE Bone Saw, stainless steel	12 mm
27-1564-18	Blade replacement	fits 27-1564 CHARRIERE Bone Saw, stainless steel	18 mm



27-1550



27-1560



27-1564

MILTEX® POST MORTEM INSTRUMENTS

VIRCHOW Brain Sectioning Knife 420
Post Mortem Hammer 421

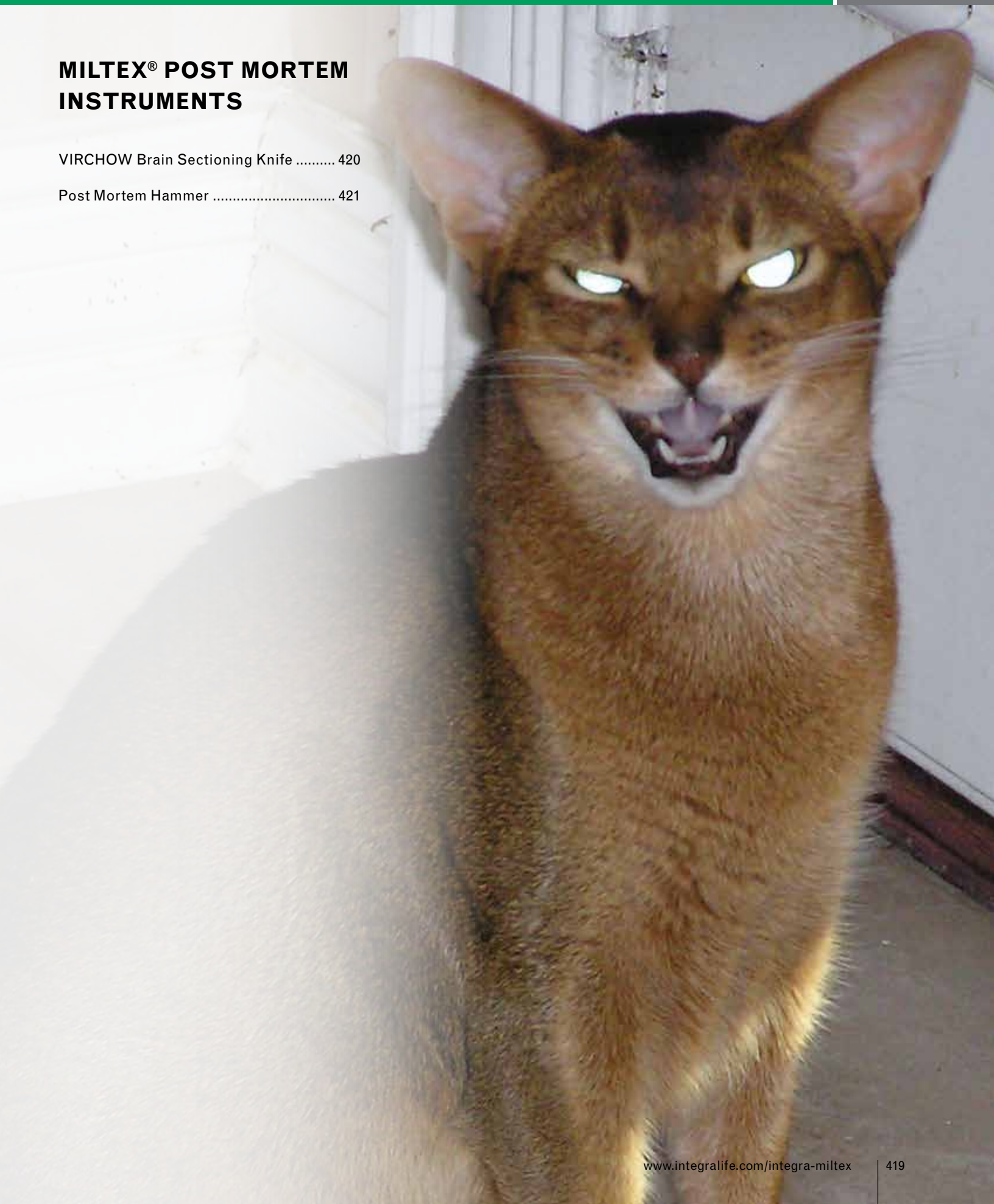

Post Mortem

REF	Description	Tips/Blade	Length
34-50	VIRCHOW Brain Sectioning Knife	blade 160 mm x 20 mm, double edge	-
34-52	VIRCHOW Brain Sectioning Knife	blade 200 mm x 30 mm, double edge	-
34-80	Dissecting Scissors	straight, two sharp points, economy grade	4-1/2" (11.4 cm)
34-92	RICHTER Dissecting Scissors	angular blades, one sharp & one blunt point	5" (12.7 cm)
34-98	Enterotomy Scissors	hook blade	8-1/4" (21 cm)
30-2605	DUBOIS Scissors	curved, extra heavy pattern, blunt points	10-1/2" (26.7 cm)



34-50
34-52



34-80



34-92



34-98



30-2605

Post Mortem

REF	Description	Tips/Blades	Length
25-362	STILLE Pattern Rib Shears	-	8-1/2" (21.6 cm)
27-1390	LISTON Bone Cutting Forceps	straight	5-1/2" (14 cm)
34-210	VIRCHOW Skull Breaker	blade 1/2" (1.3 cm) wide	3" (7.6 cm)
34-220	Post Mortem Hammer	with hook handle	9-1/2" (24.1 cm)
34-250	Dissecting Tenaculum	sharp point	6-1/2" (16.5 cm)
34-256	Aneurysm Needle	blunt tip with eye	6-1/2" (16.5 cm)



25-362



27-1390



34-210



34-220



34-250

34-256

MILTEX® SPAY, NEUTER & CASTRATION INSTRUMENTS

Canine and Feline Spay Kit 424

Neuter and Emasculation Instruments 425



Clinician Spotlight

The Shepherd Spay

It is 2:15 and the last surgery scheduled has begun. The day has been full of surprises, the surgery staff are late for their lunch breaks, I am tired and my feet ache. The radio is blasting yet I can still hear my stomach gurgling—afternoon appointments start in 45 minutes.

I had only one more spay to go - an obese German Shepherd. As I curse myself for making an exception to the hospital's policy of "no in-heat spays," and recommending a gastropexy while I am at it, I proceed. I clamp with Rochester-Carmalt forceps then double ligate each pedicle and finish the spay. In the seconds it takes to obtain and open the suture to start the gastropexy I turn back to a belly full of blood. A minute, two packs of lap sponges, 150 heart beats and 3 additional Rochester-Carmalt clamps later, I breathe a sigh of relief. I have yet to find out what was bleeding, but I have quickly isolated every pedicle, grasped it, clamped it and all bleeding has ceased.

In my head, I run through the method taught in vet school "triple clamp, double ligate, grasp pedicle with hemostats to monitor for hemorrhage as the final clamp is released." The final step I had skipped in my hurry to finish the spay. Now I diligently grasp each pedicle with mosquito hemostats and release the Rochester-Carmalt forceps that may be currently preventing the poor dog's exsanguination. The guilty vessel is isolated, transfixed and I move on.

Hours later, she has recovered well, is wagging her tail and I congratulate myself. Not for staying calm when faced with a belly full of blood, or managing to be on time for my 3pm appointment—but instead for something I had done months before. I replaced that spay pack that had long passed its prime. You know the one; it has the Rochester-Carmalt forceps with the loose ratchets, dull Metzenbaum scissors and Olsen-Hegar needle drivers that no longer consistently grasp suture. Because, in that minute when I faltered in my surgical technique, I knew I could count on my Miltex® Instruments.

By Laura Putnam, DVM



Otis belongs to Dr. Laura Putnam

Canine & Feline Spay Kit

CANINE REF# 6810

Set includes:

Qty.	REF	Description	Length	
1	4-7	#3 Scalpel Handle	-	(1)
1	5-124	MAYO Scissors	6-3/4" (17.1 cm) straight	(2)
1	6008	SNOOK Ovariectomy Hook	-	(3)
2	7-38	KELLY Hemostat	5-1/2" (14 cm) curved	(4)
1	5-182	METZENBAUM Scissors	7" (17.8 cm) curved	(5)
1	6-44	Tissue Forceps	5-1/2" (14 cm) 1x2 teeth	(6)
1	16-6	ALLIS Tissue Forceps	6" (15.2 cm) 4x5 teeth	(7)
4	7-504	BACKHAUS Towel Clamps	3-1/2" (8.9 cm)	(8)
1	6-124	BROWN-ADSON Forceps	4-3/4" (12.1 cm) 7x7 teeth	(9)
1	8-16TC	OLSEN-HEGAR Needle Holder	6-1/2" (16.5 cm)	(10)
2	7-4	HALSTED Mosquito Forceps	5" (12.7 cm) curved	(11)
2	7-172	ROCHESTER-CARMALT Forceps	6-1/4" (15.9 cm) curved	(12)
1	3-6815	Storage Cassette	15" x 8-1/4" x 1-1/4"	(13)

FELINE REF# 6820

Set includes:

Qty.	REF	Description	Length	
1	4-7	#3 Scalpel Handle	-	(1)
1	5-124	MAYO Scissors	6-3/4" (17.1 cm) straight	(2)
1	6008	SNOOK Ovariectomy Hook	-	(3)
2	7-38	KELLY Hemostat	5-1/2" (14 cm) curved	(4)
1	5-182	METZENBAUM Scissors	7" (17.8 cm) curved	(5)
1	6-44	Tissue Forceps	5-1/2" (14 cm) 1x2 teeth	(6)
1	16-6	ALLIS Tissue Forceps	6" (15.2 cm) 4x5 teeth	(7)
4	7-504	BACKHAUS Towel Clamps	3-1/2" (8.9 cm)	(8)
1	6-124	BROWN-ADSON Forceps	4-3/4" (12.1 cm) 7x7 teeth	(9)
1	8-15TC	OLSEN-HEGAR Needle Holder	5-1/2" (14 cm) (feline)	(10)
2	7-4	HALSTED Mosquito Forceps	5" (12.7 cm) curved	(11)
2	7-172	ROCHESTER-CARMALT Forceps	6-1/4" (15.9 cm) curved	(12)
1	3-6815	Storage Cassette	15" x 8-1/4" x 1-1/4"	(13)



Neuter & Emasculation Instruments

REF	Description	Type	Length
6000-SS	WHITE Improved Emasculator	double crush, stainless	12" (30.5 cm)
6004	Small WHITE Emasculator	double crush	8" (20.3 cm)
6001-CH	PLAIN Emasculator	chrome	12" (30.5 cm)
6001-SS	PLAIN Emasculator	stainless	12" (30.5 cm)
6003-CH	FRANK Emasculator	chrome	9" (22.9 cm)
6003-SS	FRANK Emasculator	stainless	9" (22.9 cm)
6006	COVAULT Ovariohysterectomy Hook	with probe tip	8-1/4" (21 cm)
6008	SNOOK Ovariohysterectomy Hook	-	8" (20.3 cm)
V96010	Emasculatome	with cord stop	9" (22.9 cm)
V96011	Emasculatome	with cord stop	12" (30.5 cm)
V96012	Emasculatome	with cord stop	14" (35.5 cm)
V96014	REIMER Emasculator	-	-



6000-SS
6004

6001-CH
6001-SS

6003-CH
6003-SS

6006

6008

V96010
V96011
V96012

MILTEX® MEISTERHAND® INSTRUMENTS

Instrument Kits.....	428
Mayo Dissecting Scissors Tungsten Carbide and SuperCut	429
Metzenbaum Scissors Tungsten Carbide and SuperCut	430
Iris Scissors Tungsten Carbide and SuperCut	431
Mayo Dissecting Scissors	432
Metzenbaum Scissors	433
Operating Scissors.....	434
Stitch Scissors.....	435-436
Iris and Strabismus Scissors	437-438
Stevens Scissors	439-440
Bandage Scissor & Cast Instruments	441
Pin & Wire Instruments	442
Dressing & Tissue Forceps	443-447
Splinter Forceps.....	448
Tissue Forceps.....	449-450
Hemostatic Forceps	451-455
Towel Clamps	456
Needle Holders.....	457-462
Bone Forceps	463
Alligator Ear Forceps	464
Retractors	465-472
Specula	473
Hooks	474-475
Rasps.....	476
Suction Tubes	477
Curettes	478-479
Rongeurs.....	480
Mallets.....	481
Osteotomes	482-483
Elevators	484
Biopsy Forceps.....	485
Scalpel Handles	486
Saws	487





I N T R O D U C T I O N

Meisterhand™ Instruments are expertly crafted from German surgical grade stainless steel to meet the very high standards demanded by the Hospital and Treatment Room clinical staff.

This advantageously priced product is ideal for cost containment while offering greater quality and value compared to instruments from any other source.

A wide range of General Instruments is included in the Meisterhand™ line as well as an extensive selection of Specialty Instrumentation, both manufactured with our unique matte finish, and ideal for a variety of surgical procedures and settings.

General Surgery Kit

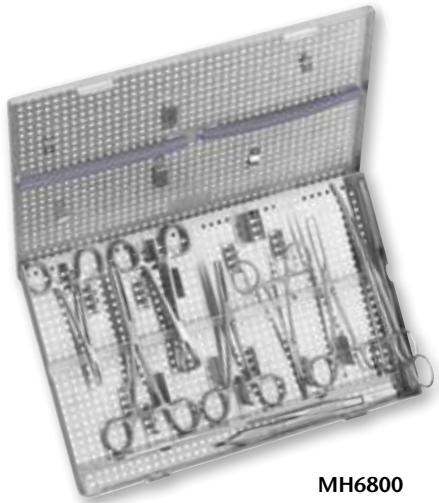

MH6800

REF# MH6800 General Surgery Kit Includes

Qty.	REF	Description	Length
1	MH5-124	MAYO Scissors	6-3/4" (17.1 cm) straight
1	MH4-7	#3 Scalpel Handle	-
1	MH6008	SNOOK Ovariectomy Hook	-
3	MH7-4	HALSTED Mosquito Forceps	5" (12.7 cm) curved
2	MH7-36	KELLY Forceps	5-1/2" (14 cm) straight
1	MH5-182	METZENBAUM Scissors	7" (17.8 cm) curved
1	MH6-124	BROWN-ADSON Forceps	4-3/4" (12.1 cm) 7x7 teeth
4	MH7-172	ROCHESTER-CARMALT Forceps	6-1/4" (15.9 cm) curved
4	MH7-506	BACKHAUS Towel Clamps	5-1/4" (13.3 cm)
1	8-15TC	OLSEN-HEGAR Needle Holder	5-1/2" (14 cm)
1	3-6815	Storage Cassette	15" x 8-1/4" x 1-1/4"

Canine & Feline Spay Kit



**MH6810
MH6820**

CANINE REF# MH6810 FELINE REF# MH6820

Set includes:

Qty.	REF	Description	Length
1	MH4-7	#3 Scalpel Handle	-
1	MH5-124	MAYO Scissors	6-3/4" (17.1 cm) straight
1	MH6008	SNOOK Ovariectomy Hook	-
2	MH7-38	KELLY Hemostat	5-1/2" (14 cm) curved
1	MH5-182	METZENBAUM Scissors	7" (17.8 cm) curved
1	MH6-44	Tissue Forceps	5-1/2" (14 cm) 1x2 teeth
1	MH16-6	ALLIS Tissue Forceps	6" (15.2 cm) 4x5 teeth
4	MH7-504	BACKHAUS Towel Clamps	4" (10.2 cm)
1	MH6-124	BROWN-ADSON Forceps	4-3/4" (12.1 cm) 7x7 teeth
1	8-16TC	OLSEN-HEGAR Needle Holder	6-1/2" (16.5 cm) (canine)
1	8-15TC	OLSEN-HEGAR Needle Holder	5-1/2" (14 cm) (feline)
2	MH7-4	HALSTED Mosquito Forceps	5" (12.7 cm) curved
2	MH7-172	ROCHESTER-CARMALT Forceps	6-1/4" (15.9 cm) curved
1	3-6815	Storage Cassette	15" x 8-1/4" x 1-1/4"

Mayo Dissecting Scissors, Tungsten Carbide and SuperCut

REF	Description	Type	Length
MH5-120TC	MAYO Dissecting Scissors	straight, standard beveled blades, tungsten carbide blades	5-1/2" (14 cm)
MH5-122TC	MAYO Dissecting Scissors	curved, standard beveled blades, tungsten carbide blades	5-1/2" (14 cm)
MH5-124TC	MAYO Dissecting Scissors	straight, standard beveled blades, tungsten carbide blades	6-3/4" (17.1 cm)
MH5-126TC	MAYO Dissecting Scissors	curved, standard beveled blades, tungsten carbide blades	6-3/4" (17.1 cm)
MH5-128TC	MAYO Dissecting Scissors	straight, standard beveled blades, tungsten carbide blades	9" (22.9 cm)
MH5-130TC	MAYO Dissecting Scissors	curved, standard beveled blades, tungsten carbide blades	9" (22.9 cm)
MH5-SC-120	SuperCut MAYO Scissors	straight	5-1/2" (14 cm)
MH5-SC-122	SuperCut MAYO Scissors	curved	5-1/2" (14 cm)
MH5-SC-124	SuperCut MAYO Scissors	straight	6-3/4" (17.1 cm)
MH5-SC-126	SuperCut MAYO Scissors	curved	6-3/4" (17.1 cm)
MH5-SC-128	SuperCut MAYO Scissors	straight	9" (22.9 cm)
MH5-SC-130	SuperCut MAYO Scissors	curved	9" (22.9 cm)

*For easy identification, MeisterHand® SuperCut scissors have two black finger rings & tungsten carbide scissors have two gold-plated finger rings



MH5-120TC
MH5-124TC
MH5-128TC

MH5-122TC
MH5-126TC
MH5-130TC

MH5-SC-120
MH5-SC-124
MH5-SC-128

MH5-SC-122
MH5-SC-126
MH5-SC-130

Metzenbaum Scissors, Tungsten Carbide and SuperCut

REF	Description	Type	Tips	Length
MH5-179TC	METZENBAUM Scissors	straight, standard pattern, tungsten carbide blades	blunt	5-1/2" (14 cm)
MH5-180TC	METZENBAUM Scissors	curved, standard pattern, tungsten carbide blades	blunt	5-1/2" (14 cm)
MH5-182TC	METZENBAUM Scissors	curved, standard pattern, tungsten carbide blades	blunt	7" (17.8 cm)
MH5-182A-TC	METZENBAUM Scissors	curved, delicate pattern, tungsten carbide blades	blunt	7" (17.8 cm)
MH5-SC-180	SuperCut METZENBAUM Scissors	curved	blunt	5-1/2" (14 cm)
MH5-SC-182	SuperCut METZENBAUM Scissors	curved	blunt	7" (17.8 cm)

*For easy identification, MeisterHand® SuperCut scissors have two black finger rings & tungsten carbide scissors have two gold-plated finger rings



MH5-180TC



MH5-182TC



MH5-182ATC

MH5-179TC



MH5-SC-180



MH5-SC-182

Iris & Strabismus Scissors, Tungsten Carbide and SuperCut

REF	Description	Type	Length
MH5-304TC	Iris Scissors	straight, tungsten carbide blades	4-1/2" (11.4 cm)
MH5-SC-304	SuperCut Iris Scissors	straight	4-1/2" (11.4 cm)
MH5-306TC	Iris Scissors	curved, tungsten carbide blades	4-1/2" (11.4 cm)
MH5-SC-306	SuperCut Iris Scissors	curved	4-1/2" (11.4 cm)
MH5-312TC	Strabismus Scissors	straight, tungsten carbide blades	4-1/2" (11.4 cm)
MH5-314TC	Strabismus Scissors	curved, tungsten carbide blades	4-1/2" (11.4 cm)

*For easy identification, MeisterHand® SuperCut scissors have two black finger rings & tungsten carbide scissors have two gold-plated finger rings

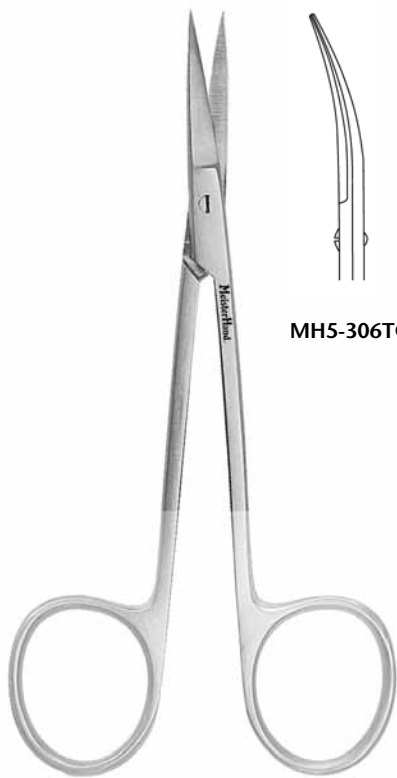

MH5-304TC

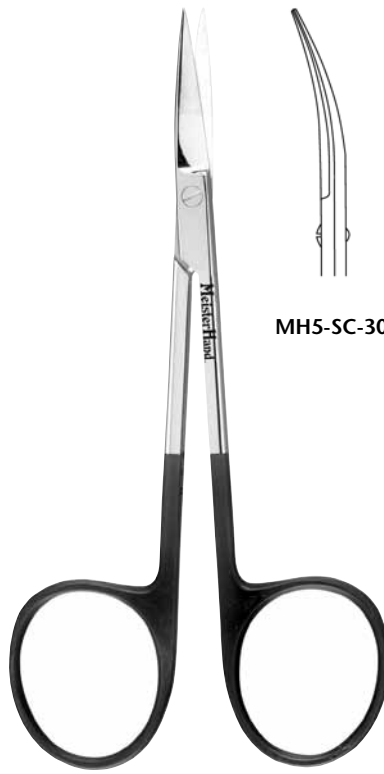

MH5-SC-304

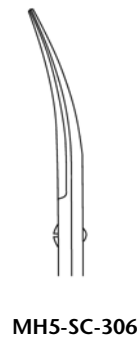

MH5-312TC

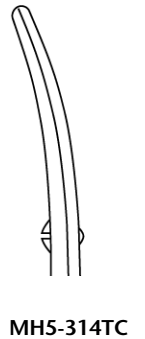

Mayo Dissecting Scissors

REF	Description	Type	Length
MH5-120	MAYO Dissecting Scissors	straight, standard beveled blades	5-1/2" (14 cm)
MH5-122	MAYO Dissecting Scissors	curved, standard beveled blades	5-1/2" (14 cm)
MH5-124	MAYO Dissecting Scissors	straight, standard beveled blades	6-3/4" (17.1 cm)
MH5-126	MAYO Dissecting Scissors	curved, standard beveled blades	6-3/4" (17.1 cm)
MH5-128	MAYO Dissecting Scissors	straight, standard beveled blades	9" (22.9 cm)
MH5-130	MAYO Dissecting Scissors	curved, standard beveled blades	9" (22.9 cm)



MH5-120
MH5-124
MH5-128



MH5-122
MH5-126
MH5-130

Metzenbaum Scissors

REF	Description	Type	Tips	Length
MH5-179	METZENBAUM (LAHEY) Scissors	standard pattern, straight	blunt	5-1/2" (14 cm)
MH5-180	METZENBAUM (LAHEY) Scissors	standard pattern, curved	blunt	5-1/2" (14 cm)
MH5-181	METZENBAUM Scissors	standard pattern, straight	blunt	7" (17.8 cm)
MH5-182	METZENBAUM Scissors	standard pattern, curved	blunt	7" (17.8 cm)
MH5-288	METZENBAUM Scissors	delicate pattern, curved	blunt	7" (17.8 cm)



MH5-180

MH5-179



MH5-182

MH5-181



MH5-288

Operating Scissors

REF	Description	Type	Tips	Length
MH5-2	Standard Pattern Operating Scissors	straight	sharp/sharp	4-1/2" (11.4 cm)
MH5-4	Standard Pattern Operating Scissors	straight	sharp/sharp	5" (12.7 cm)
MH5-6	Standard Pattern Operating Scissors	straight	sharp/sharp	5-1/2" (14 cm)
MH5-8	Standard Pattern Operating Scissors	straight	sharp/sharp	6-1/2" (16.5 cm)
MH5-12	Standard Pattern Operating Scissors	straight	sharp/blunt	4-1/2" (11.4 cm)
MH5-14	Standard Pattern Operating Scissors	straight	sharp/blunt	5" (12.7 cm)
MH5-16	Standard Pattern Operating Scissors	straight	sharp/blunt	5-1/2" (14 cm)
MH5-18	Standard Pattern Operating Scissors	straight	sharp/blunt	6-1/2" (16.5 cm)
MH5-22	Standard Pattern Operating Scissors	straight	blunt/blunt	4-1/2" (11.4 cm)
MH5-24	Standard Pattern Operating Scissors	straight	blunt/blunt	5" (12.7 cm)
MH5-26	Standard Pattern Operating Scissors	straight	blunt/blunt	5-1/2" (14 cm)
MH5-36	Standard Pattern Operating Scissors	curved	sharp/sharp	5-1/2" (14 cm)
MH5-46	Standard Pattern Operating Scissors	curved	sharp/blunt	5-1/2" (14 cm)
MH5-56	Standard Pattern Operating Scissors	curved	blunt/blunt	5-1/2" (14 cm)



MH5-2 to
MH5-8



MH5-12 to
MH5-18



MH5-22 to
MH5-26



MH5-36



MH5-46



MH5-56

Stitch Scissors

REF	Description	Type	Tips	Length
MH5-270	Delicate Scissors	straight	sharp-sharp	4-3/4" (12.1 cm)
MH5-272	Delicate Scissors	straight	sharp-blunt	4-3/4" (12.1 cm)
MH5-274	Delicate Scissors	straight	blunt-blunt	4-3/4" (12.1 cm)
MH5-276	Delicate Scissors	curved	sharp-sharp	4-3/4" (12.1 cm)
MH5-278	Delicate Scissors	curved	sharp-blunt	4-3/4" (12.1 cm)
MH5-280	Delicate Scissors	curved	blunt-blunt	4-3/4" (12.1 cm)



MH5-272



MH5-270



MH5-274



MH5-278



MH5-276



MH5-280

Stitch Scissors

REF	Description	Type	Length
MH9-98	NEW'S Suture Scissors	angled on flat	5-1/2" (14 cm)
MH9-100	SPENCER Stitch Scissors	delicate	3-1/2" (8.9 cm)
MH9-102	LITTAUER Jr. Stitch Scissors	light pattern	4-1/2" (11.4 cm)
MH9-104	LITTAUER Stitch Scissors	standard pattern	5-1/2" (14 cm)
MH9-110	O'BRIEN Stitch Scissors	angled, sharp	3-3/4" (9.5 cm)
MH18-1486	WESTCOTT Stitch Scissors	curved, sharp	4-1/2" (11.4 cm)



MH9-98



MH9-100



**MH9-102
MH9-104**



MH9-110



MH18-1486

Iris Scissors

REF	Description	Type	Length
MH5-300	Iris Scissors	straight	4" (10.2 cm)
MH5-302	Iris Scissors	curved	4" (10.2 cm)
MH5-304	Iris Scissors	straight	4-1/2" (11.4 cm)
MH5-306	Iris Scissors	curved	4-1/2" (11.4 cm)
MH18-1396	Iris Scissors	straight, with 20 mm blades, delicate	3-1/2" (8.9 cm)
MH18-1398	Iris Scissors	curved, with 20 mm blades, delicate	3-1/2" (8.9 cm)
MH18-1415	Iris Scissors	straight, standard pattern, ribbon-type	4" (10.2 cm)
MH18-1416	Iris Scissors	curved, standard pattern, ribbon-type	4" (10.2 cm)
MH18-1417	Iris Scissors	straight, miniature pattern with 14 mm blades, ribbon-type	3-3/4" (9.5 cm)
MH18-1418	Iris Scissors	curved, miniature pattern with 14 mm blades, ribbon-type	3-3/4" (9.5 cm)



MH5-302
MH5-306

MH5-300
MH5-304



MH18-1398

MH18-1396



MH18-1416

MH18-1415



MH18-1418

MH18-1417

Iris & Strabismus Scissors

REF	Description	Type	Length
MH5-312	Strabismus Scissors	straight	4" (10.2 cm)
MH5-314	Strabismus Scissors	curved	4" (10.2 cm)
MH5-264	DEAN Dissecting Scissors	blades angled on flat, one serrated blade	6-3/4" (17.1 cm)
MH18-1420	KNAPP Iris Scissors	straight, sharp/blunt	4" (10.2 cm)
MH18-1422	KNAPP Iris Scissors	straight, blunt/blunt	4" (10.2 cm)
MH18-1426	KNAPP Iris Scissors	curved, sharp/blunt	4" (10.2 cm)
MH18-1428	KNAPP Iris Scissors	curved, blunt/blunt	4" (10.2 cm)

*For easy identification, MeisterHand® SuperCut scissors have two black finger rings & tungsten carbide scissors have two gold-plated finger rings



MH5-314

MH5-312



MH5-264



MH18-1426

MH18-1420



MH18-1428

MH18-1422

STEVENS Tenotomy & Eye Scissors

REF	Description	Type	Tips	Length
MH18-1460	STEVENS Tenotomy Scissors	straight, short blades	sharp	4-1/8" (10.5 cm)
MH18-1462	STEVENS Tenotomy Scissors	straight, short blades	blunt	4-1/8" (10.5 cm)
MH18-1464	STEVENS Tenotomy Scissors	curved, short blades	sharp	4-1/8" (10.5 cm)
MH18-1466	STEVENS Tenotomy Scissors	curved, short blades	blunt	4-1/8" (10.5 cm)
MH18-1472	STEVENS Tenotomy Scissors	straight, long blades	blunt	4-1/2" (11.4 cm)
MH18-1476	STEVENS Tenotomy Scissors	curved, long blades	blunt	4-1/2" (11.4 cm)
MH18-1572	CASTROVIEJO Corneal Scissors	angled blades, 11 mm	blunt	3-3/4" (9.5 cm)
MH18-1576	CASTROVIEJO Corneal Scissors	curved	sharp	3-3/4" (9.5 cm)
MH18-1578	CASTROVIEJO Corneal Scissors	curved	blunt	3-3/4" (9.5 cm)
MH18-1620	VANNAS Capsulotomy Scissors	straight, extra delicate	sharp	3-1/4" (8.3 cm)
MH18-1622	VANNAS Capsulotomy Scissors	curved, extra delicate	sharp	3-1/4" (8.3 cm)
MH18-1652	Eye Suture (GRADLE) Scissors	slightly curved	sharp	3-3/4" (9.5 cm)
MH18-1653	Eye Suture Scissors	ribbon type, slightly curved	sharp	4" (10.2 cm)



MH18-1460



MH18-1464



MH18-1472



MH18-1572



MH18-1576



MH18-1620



MH18-1652



MH18-1653

Scissors

REF	Description	Type	Length
MH21-536	LITTLER Suture Carrying Scissors	with suture hole in blades, curved	4-5/8" (11.8 cm)
MH21-600	FOMON Scissors	saber back, slightly curved, semi-sharp outer edges	5" (12.7 cm)
MH21-602	FOMON Lower Lateral Scissors	strong curve, dissecting blades	5" (12.7 cm)
MH21-604	FOMON Dorsal Scissors	light pattern, angular shank	5-1/2" (14 cm)
MH21-610	COTTLE Dorsal Scissors	heavy pattern with rounded blades, angular shank	6-1/2" (16.5 cm)
MH21-630	JOSEPH Scissors	straight	5-3/4" (14.6 cm)
MH21-632	JOSEPH Scissors	curved	5-3/4" (14.6 cm)
MH27-1000	MARTIN Cartilage Scissors	curved, serrated non-slip cutting edge	8" (20.3 cm)



MH21-536



MH21-600

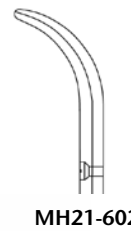

MH21-602



MH21-604



MH21-610



MH21-630



MH21-632



MH27-1000

Bandage Scissors & Cast Instruments

REF	Description	Type	Length
MH5-512	LISTER Bandage Scissors	fine	4-1/2" (11.4 cm)
MH5-514	LISTER Bandage Scissors	fine	5-1/2" (14 cm)
MH5-516	LISTER Bandage Scissors	fine	7-1/4" (18.4 cm)
MH5-550	LISTER Bandage Scissors	with one large finger ring	8" (20.3 cm)
MH5-560	KNOWLES Bandage Scissors	straight	5-1/2" (14 cm)
MH5-568	ESMARCH Heavy Duty Bandage & Cast Shears	-	8" (20.3 cm)
MH27-3070	Bruns Plaster Shears	serrated blade	9-1/4" (23.5 cm)
MH27-3100	Three Prong Cast Spreader	with spring action for one-handed operation	9" (22.9 cm)



MH5-512 to
MH5-516



MH5-550



MH5-560



MH5-568



MH27-3070



MH27-3100

Pin & Wire

REF	Description	Type	Length
MH27-160	DIAMOND Pin and Wire Cutter	cuts up to 2 mm (5/64") diameter hard wire, stainless	6-1/2" (16.5 cm)
MH9-124	Wire Cutting Scissors	angled to side, one serrated blade	4-3/4" (12.1 cm)
MH9-124TC	Wire Cutting Scissors	angled to side, one serrated blade, tungsten carbide jaws	4-3/4" (12.1 cm)



MH27-160



MH9-124
MH9-124TC

Dressing & Tissue Forceps

REF	Description	Type	Length
MH6-4	Dressing Forceps	standard pattern serrated handles, serrated tips	4-1/2" (11.4 cm)
MH6-6	Dressing Forceps	standard pattern serrated handles, serrated tips	5" (12.7 cm),
MH6-8	Dressing Forceps	standard pattern serrated handles, serrated tips	5-1/2" (14 cm)
MH6-10	Dressing Forceps	standard pattern serrated handles serrated tips	6" (15.2 cm)
MH6-14	Dressing Forceps	standard pattern serrated handles, serrated tips	8" (20.3 cm)
MH6-40	Tissue Forceps	1 x 2 teeth, standard pattern serrated handles	4-1/2" (11.4 cm)
MH6-42	Tissue Forceps	1 x 2 teeth, standard pattern serrated handles	5" (12.7 cm)
MH6-44	Tissue Forceps	1 x 2 teeth, standard pattern serrated handles	5-1/2" (14 cm)
MH6-46	Tissue Forceps	1 x 2 teeth, standard pattern serrated handles	6" (15.2 cm)
MH6-48	Tissue Forceps	1 x 2 teeth, standard pattern serrated handles	8" (20.3 cm)
MH6-104	SEMKEN Dressing Forceps	serrated	5" (12.7 cm)
MH6-106	SEMKEN Tissue Forceps	1 x 2 teeth	5" (12.7 cm)
MH6-118	ADSON Dressing Forceps	delicate, serrated	4-3/4" (12.1 cm)
MH6-118TC	ADSON Dressing Forceps	cross serrated tips, tungsten carbide blades	4-3/4" (12.1 cm)
MH6-120	ADSON Tissue Forceps	1 x 2 teeth, delicate	4-3/4" (12.1 cm)
MH6-121	ADSON Tissue Forceps	1 x 2 teeth, cross serrated tips, delicate	4-3/4" (12.1 cm)
MH6-122	ADSON Tissue Forceps	2 x 3 teeth, delicate	4-3/4" (12.1 cm)
MH6-123	ADSON Tissue & Suture Forceps	1 x 2 teeth, with tying platform	4-3/4" (12.1 cm)
MH6-124	BROWN-ADSON Tissue Forceps	7 x 7 side grasping teeth	4-3/4" (12.1 cm)

*For easy identification, MeisterHand® tungsten carbide forceps have gold-plated ends

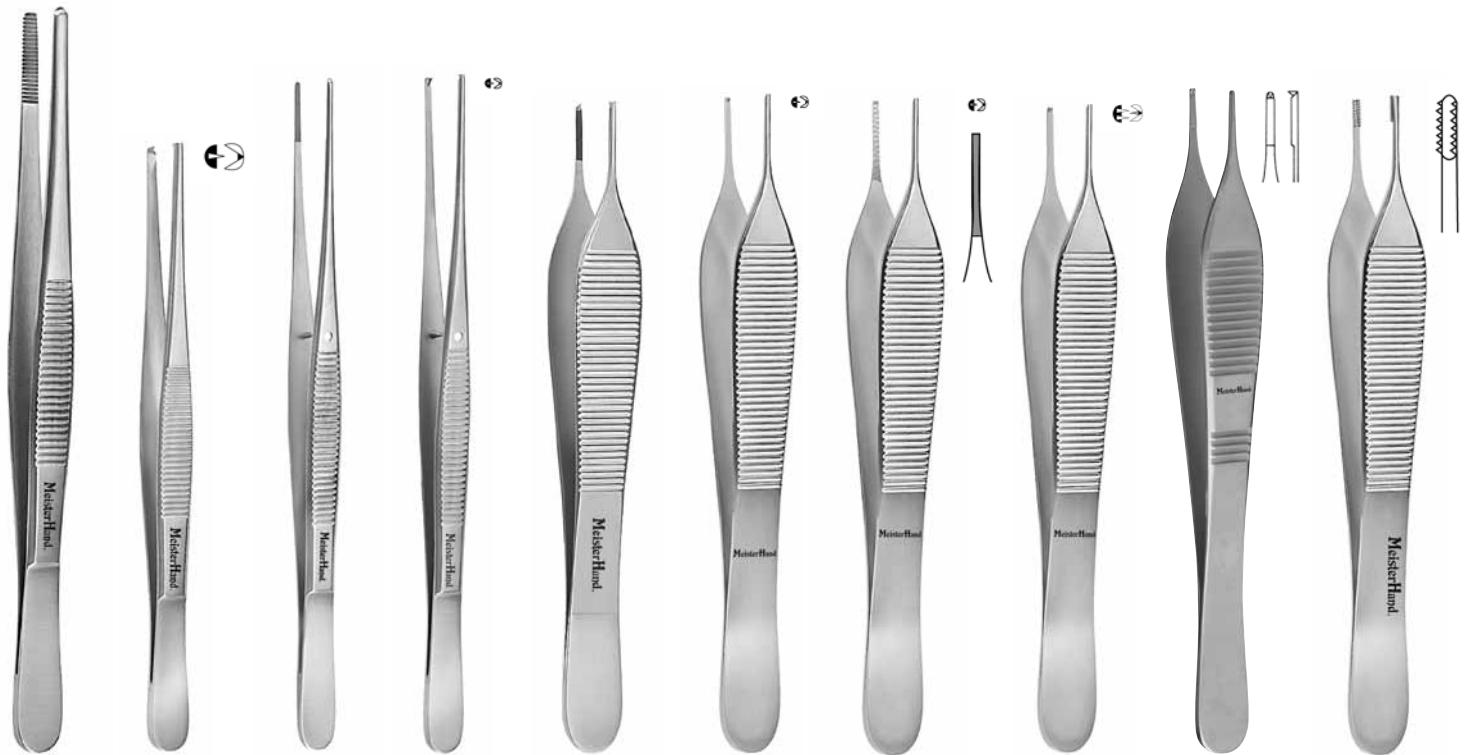

MH6-4 to
MH6-14

MH6-40 to
MH6-48

MH6-104

MH6-106

MH6-118
MH6-118TC

MH6-120

MH6-121

MH6-122

MH6-123

MH6-124

Dressing & Tissue Forceps

REF	Description	Type	Length
MH17-2500	Micro ADSON Tissue Forceps	tips 0.5 mm wide, 1 x 2 teeth	4-3/4" (12.1 cm)
MH17-2510	Micro ADSON Dressing Forceps	tips 0.5 mm wide, serrated jaws	4-3/4" (12.1 cm)
MH6-142	RUSSIAN Tissue Forceps	-	6" (15.2 cm)
MH6-144	RUSSIAN Tissue Forceps	-	8" (20.3 cm)
MH6-145	RUSSIAN Tissue Forceps	-	10" (25.4 cm)
MH6-148	BONNEY Tissue Forceps	1 x 2 teeth, serrated tips	7" (17.8 cm)
MH6-150	BONNEY Tissue Forceps	2 x 3 teeth, serrated tips	7" (17.8 cm)
MH6-154	POTTS-SMITH Dressing Forceps	serrated tips	7" (17.8 cm)
MH6-154TC	POTTS-SMITH Dressing Forceps	cross serrated tips, tungsten carbide jaws	7" (17.8 cm)
MH6-160	POTTS-SMITH Tissue Forceps	1 x 2 teeth, serrated tips	7" (17.8 cm)

*For easy identification, MeisterHand® tungsten carbide forceps have gold-plated ends



MH17-2500
MH17-2510



MH6-142 to
MH6-145



MH6-148
MH6-150



MH6-154
MH6-154TC
MH6-165TC



MH6-160

Dressing & Tissue Forceps

REF	Description	Type	Length
MH6-180	GERALD Dressing Forceps	straight, serrated	7" (17.8 cm)
MH6-182	GERALD Tissue Forceps	straight, 1 x 2 teeth	7" (17.8 cm)
MH6-190	CUSHING Dressing Forceps	bayonet, serrated, scraper end	7-1/4" (18.4 cm)
MH6-192	CUSHING Dressing Forceps	bayonet, scraper end, 1 x 2 teeth	7-1/4" (18.4 cm)
MH6-196	GRUENWALD (ADSON) Bayonet Dressing Forceps	serrated	8-1/4" (21 cm)
MH6-197	GRUENWALD (JANSEN) Bayonet Dressing Forceps	serrated	6-1/2" (16.5 cm)
MH6-198	ADSON Bayonet Dressing Forceps	serrated, delicate tips	8-1/4" (21 cm)
MH6-214	SINGLEY Tissue Forceps	fenestrated serrated jaws	9" (22.9 cm)



MH6-180



MH6-182



MH6-190
MH6-192



MH6-196
MH6-197
MH6-198



MH6-214

Dressing & Tissue Forceps

REF	Description	Type	Length
MH18-780	Eye Dressing Forceps	straight, standard pattern, 0.8 mm wide serrated tips	4" (10.2 cm)
MH18-782	Eye Dressing Forceps	half curved, standard pattern, 0.8 mm wide serrated tips	4" (10.2 cm)
MH18-784	Eye Dressing Forceps	full curved, standard pattern, 0.8 mm wide serrated tips	4" (10.2 cm)
MH18-786	Iris Tissue Forceps	1 x 2 teeth, straight, standard pattern, 0.8 mm wide tips	4" (10.2 cm)
MH18-788	Iris Tissue Forceps	1 x 2 teeth, half curved, standard pattern, 0.8 mm wide tips	4" (10.2 cm)
MH18-790	Iris Tissue Forceps	1 x 2 teeth, full curved, standard pattern, 0.8 mm wide tips	4" (10.2 cm)
MH18-835	BONN Micro Suturing Forceps	1 x 2 teeth, 0.12 mm, with tying platform	2-3/4" (7 cm)
MH18-836	BONN Micro Suturing Forceps	1 x 2 teeth, 0.12 mm, with tying platform	3-3/4" (9.5 cm)
MH18-866	BISHOP-HARMON Dressing Forceps	fine cross serrated tips, 0.5 mm wide	3-3/8" (8.6 cm)
MH18-867	BISHOP-HARMON Micro Tissue Forceps	delicate 0.3 mm, 1 x 2 teeth	3-3/8" (8.6 cm)
MH18-868	BISHOP-HARMON Tissue Forceps	standard 0.7 mm, 1 x 2 teeth	3-3/8" (8.6 cm)

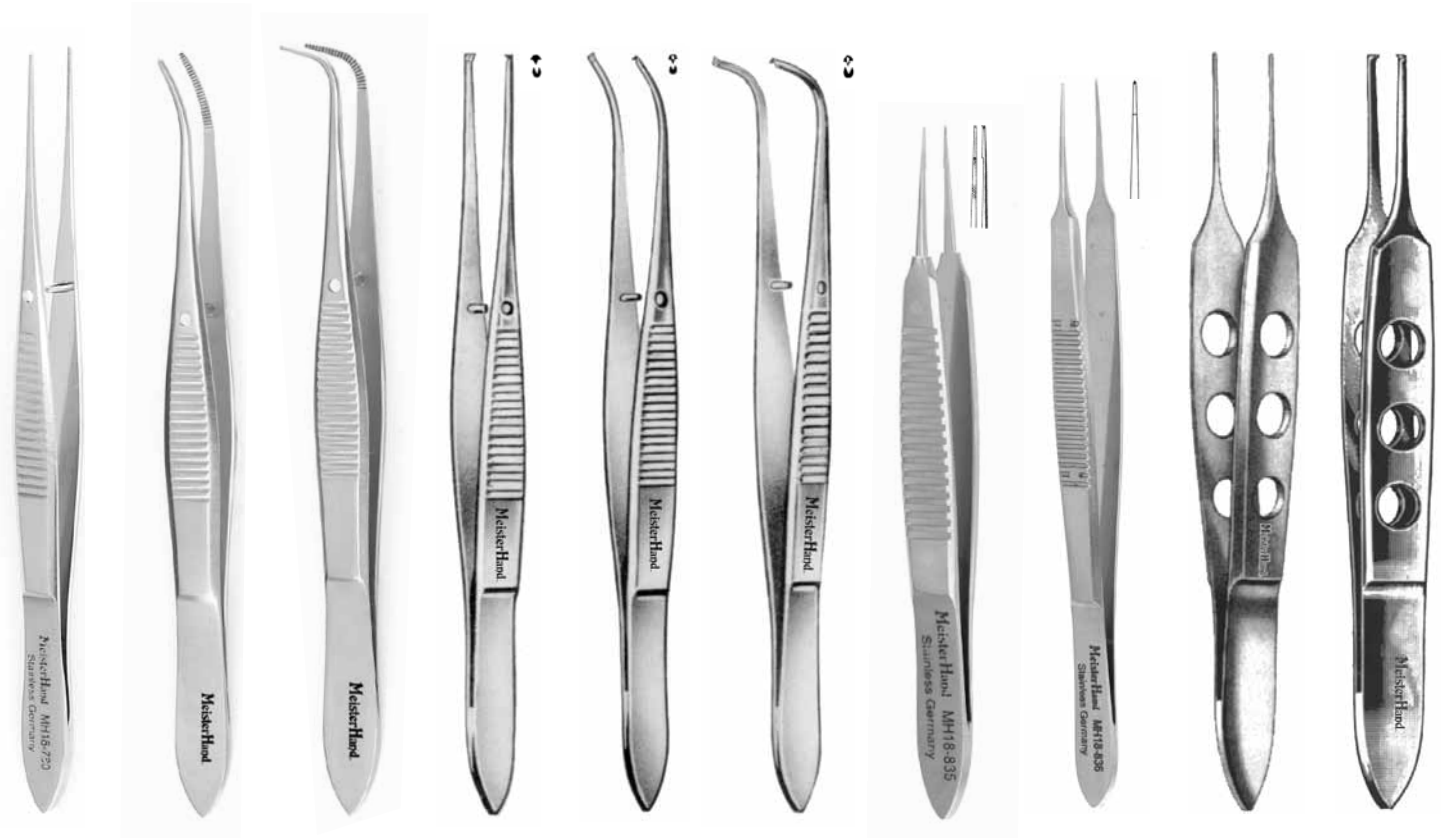

MH18-780

MH18-782

MH18-784

MH18-786

MH18-788

MH18-790

MH18-835

MH18-836

MH18-866

MH18-867
MH18-868

Dressing & Tissue Forceps

REF	Description	Type	Length
MH18-948	McPHERSON Micro Iris Suturing Forceps	straight, smooth tying platform 0.3 mm x 5 mm, no teeth	3-1/2" (8.9 cm)
MH18-949	McPHERSON Micro Iris Suturing Forceps	angled, smooth tying platform 0.3 mm x 5 mm, no teeth	3-1/2" (8.9 cm)
MH18-954	CASTROVIEJO Suturing Forceps	11 mm wide handles, 1 x 2 teeth 0.6 mm, tying platform	4" (10.2 cm)
MH18-955	CASTROVIEJO Suturing Forceps	11 mm wide handles, 1 x 2 teeth 0.9 mm, tying platform	4" (10.2 cm)
MH19-350	WILDE Dressing Forceps	angular with serrated tips	5" (12.7 cm)
MH19-370	LUCAE Dressing Forceps	bayonet shape, serrated tips	5-1/2" (14 cm)
MH26-956	FERRIS-SMITH Tissue Forceps	serrated platform tips with 1 x 2 teeth	7" (17.8 cm)
MH26-958	FERRIS-SMITH Tissue Forceps	serrated platform tips with 2 x 3 teeth	7" (17.8 cm)



MH18-948



MH18-949



MH18-954
MH18-955

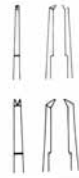

MH19-350



MH19-370



MH26-956
MH26-958



Splinter Forceps

REF	Description	Type	Length
MH6-300	Plain Splinter Forceps	-	3-1/2" (8.9 cm)
MH6-304	Plain Splinter Forceps	-	4-1/2" (11.4 cm)
MH6-316	FEILCHENFELD Splinter Forceps	-	3" (7.6 cm)
MH6-318	FEILCHENFELD Splinter Forceps	-	4-1/2" (11.4 cm)
MH6-400	Splinter Liberator	trocar point in reversible handle	5" (12.7 cm)



MH6-300
MH6-304



MH6-316
MH6-318



MH6-400

Tissue Forceps

REF	Description	Type	Length
MH16-4	Baby ALLIS Tissue Forceps	4 x 5 teeth, delicate jaws 4 mm wide	5-1/2" (14 cm)
MH16-6	ALLIS Tissue Forceps	4 x 5 teeth	6" (15.2 cm)
MH16-8	ALLIS Tissue Forceps	5 x 6 teeth	6" (15.2 cm)
MH16-10	ALLIS Tissue Forceps	5 x 6 teeth	7-1/4" (18.4 cm)
MH16-12	ALLIS Tissue Forceps	5 x 6 teeth	10" (25.4 cm)
MH16-30	ALLIS-ADAIR Tissue Forceps	9 x 10 teeth	6-1/2" (16.5 cm)
MH16-31	BOYS-ALLIS Tissue Forceps	5 x 6 teeth, heavy pattern	6" (15.2 cm)
MH16-38	THOMS-ALLIS Tissue Forceps	6 x 7 teeth	8" (20.3 cm)



MH16-4



MH16-6



MH16-8 to
MH16-12



MH16-30



MH16-31



MH16-38

Tissue Forceps

REF	Description	Type	Length
MH16-42	Baby BABCOCK Intestinal Forceps	delicate jaws 6 mm wide	5-1/2" (14 cm)
MH16-44	BABCOCK Intestinal Forceps	jaws 9 mm wide	6-1/4" (15.9 cm)
MH16-46	BABCOCK Intestinal Forceps	jaws 10 mm wide	8-1/4" (21 cm)
MH16-48	BABCOCK Intestinal Forceps	jaws 15 mm wide	9-1/2" (24.1 cm)
MH16-51	ADAIR Tissue Holding Tenaculum Forceps	-	6-1/2" (16.5 cm)
MH12-80	LAHEY Traction Forceps	3 x 3 teeth	6-1/4" (15.9 cm)



**MH16-42 to
MH16-48**



MH16-51



MH12-80

Hemostatic Forceps

REF	Description	Type	Length
MH7-2	HALSTED Mosquito Forceps	straight	5" (12.7 cm)
MH7-4	HALSTED Mosquito Forceps	curved	5" (12.7 cm)
MH7-8	HALSTED Mosquito Forceps	straight, extra delicate	5" (12.7 cm)
MH7-10	HALSTED Mosquito Forceps	curved, extra delicate	5" (12.7 cm)
MH7-24	HARTMAN Mosquito Forceps	straight	3-1/2" (8.9 cm)
MH7-26	HARTMAN Mosquito Forceps	curved	3-1/2" (8.9 cm)
MH7-36	KELLY Forceps	straight	5-1/2" (14 cm)
MH7-38	KELLY Forceps	curved	5-1/2" (14 cm)
MH7-42	CRILE Forceps	straight	5-1/2" (14 cm)
MH7-44	CRILE Forceps	curved	5-1/2" (14 cm)
MH7-46	CRILE Forceps	straight	6-1/4" (15.9 cm)
MH7-48	CRILE Forceps	curved	6-1/4" (15.9 cm)
MH7-50	Baby CRILE Forceps	extra delicate, straight	5-1/2" (14 cm)
MH7-52	Baby CRILE Forceps	extra delicate, curved	5-1/2" (14 cm)
MH7-66	KOCHER Forceps	1 x 2 teeth, straight	5-1/2" (14 cm)
MH7-68	KOCHER Forceps	1 x 2 teeth, curved	5-1/2" (14 cm)
MH7-92	RANKIN Forceps	straight	6-1/4" (15.9 cm)
MH7-94	RANKIN Forceps	curved	6-1/4" (15.9 cm)

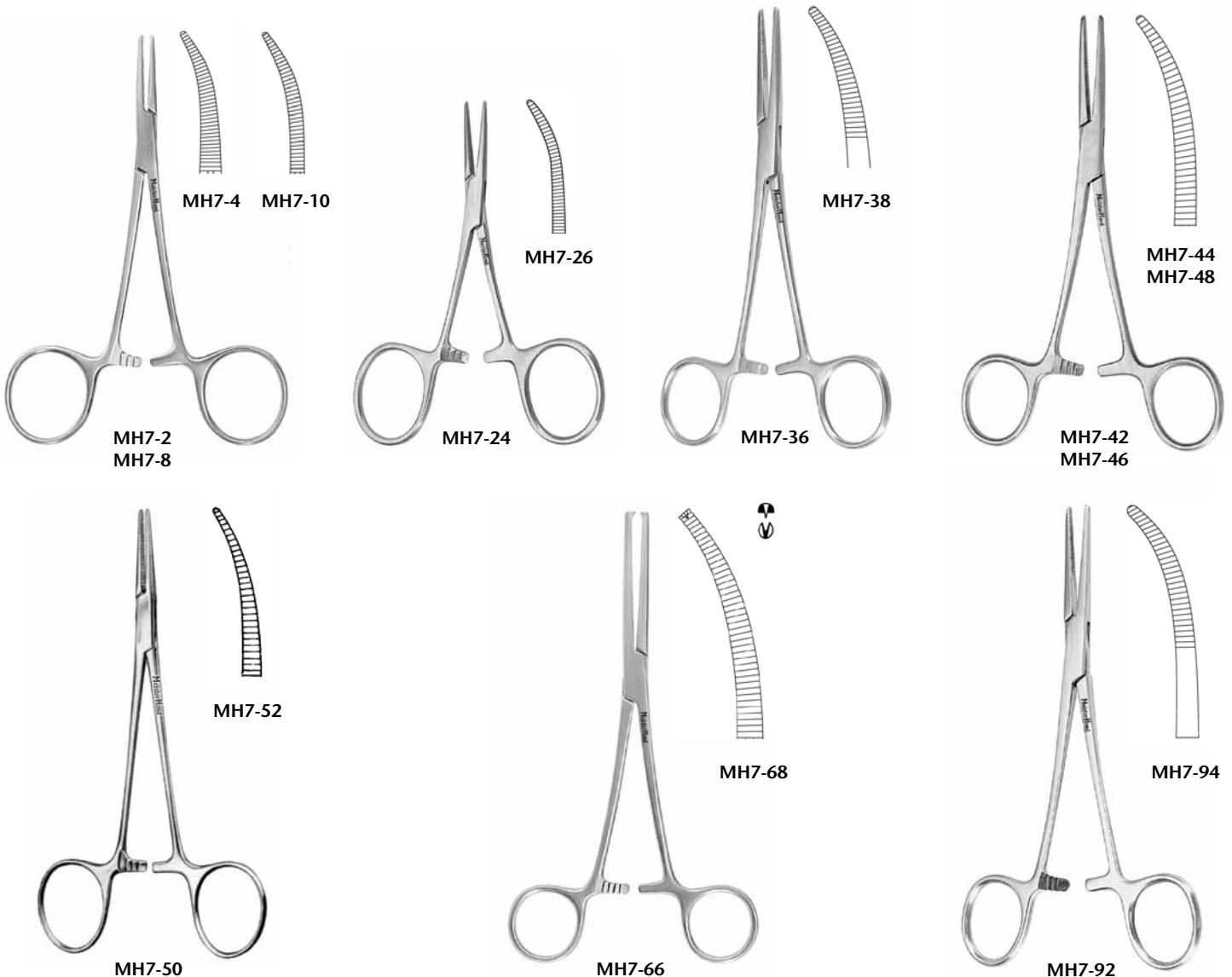

Hemostatic Forceps

REF	Description	Type	Length
MH7-102	DANDY Forceps	curved sideways	5-1/2" (14 cm)
MH7-106	PRATT T-Shape Forceps	-	6" (15.2 cm)
MH7-118	ROCHESTER-PEAN Forceps	straight	5-1/2" (14 cm)
MH7-120	ROCHESTER-PEAN Forceps	straight	6-1/4" (15.9 cm)
MH7-122	ROCHESTER-PEAN Forceps	straight	7-1/4" (18.4 cm)
MH7-124	ROCHESTER-PEAN Forceps	straight	8" (20.3 cm)
MH7-126	ROCHESTER-PEAN Forceps	straight	9" (22.9 cm)
MH7-136	ROCHESTER-PEAN Forceps	curved	5-1/2" (14 cm)
MH7-138	ROCHESTER-PEAN Forceps	curved	6-1/4" (15.9 cm)
MH7-140	ROCHESTER-PEAN Forceps	curved	7-1/4" (18.4 cm)
MH7-142	ROCHESTER-PEAN Forceps	curved	8" (20.3 cm)
MH7-144	ROCHESTER-PEAN Forceps	curved	9" (22.9 cm)



MH7-102



MH7-106



**MH7-118 to
MH7-126**

MH7-136 to MH7-144

Hemostatic Forceps

REF	Description	Type	Length
MH7-150	ROCHESTER-OCHSNER Forceps	straight	6-1/4" (15.9 cm)
MH7-152	ROCHESTER-OCHSNER Forceps	straight	7-1/4" (18.4 cm)
MH7-154	ROCHESTER-OCHSNER Forceps	straight	8" (20.3 cm)
MH7-160	ROCHESTER-OCHSNER Forceps	curved	6-1/4" (15.9 cm)
MH7-162	ROCHESTER-OCHSNER Forceps	curved	7-1/4" (18.4 cm)
MH7-164	ROCHESTER-OCHSNER Forceps	curved	8" (20.3 cm)
MH7-170	ROCHESTER-CARMALT Forceps	straight	6-1/4" (15.9 cm)
MH7-172	ROCHESTER-CARMALT Forceps	curved	6-1/4" (15.9 cm)
MH7-180	ROCHESTER-CARMALT Forceps	straight	8" (20.3 cm)
MH7-182	ROCHESTER-CARMALT Forceps	curved	8" (20.3 cm)
MH7-202	MIXTER Forceps	fully curved	7-1/4" (18.4 cm)
MH7-206	MIXTER Forceps	fully curved	9" (22.9 cm)
MH7-220	PENNINGTON Tissue Grasping Forceps	triangular jaws	6" (15.2 cm)
MH7-221	PENNINGTON Tissue Grasping Forceps	triangular jaws	8" (20.3 cm)
MH7-240	ADSON Forceps	straight	7-1/4" (18.4 cm)
MH7-242	ADSON Forceps	curved	7-1/4" (18.4 cm)



MH7-150 to
MH7-154

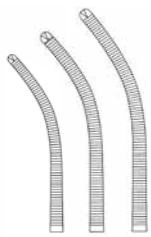

MH7-160 to
MH7-164



MH7-170
MH7-180

MH7-172
MH7-182



MH7-202
MH7-206



MH7-220
MH7-221



MH7-240
MH7-242

Hemostatic Forceps

REF	Description	Type	Length
MH7-255	GEMINI-MIXTER Hemostatic Forceps	delicate, full curved jaws	5-1/2" (14 cm)
MH7-256	GEMINI-MIXTER Hemostatic Forceps	delicate, full curved jaws	7" (17.8 cm)
MH7-257	GEMINI-MIXTER Hemostatic Forceps	delicate, full curved jaws	8" (20.3 cm)
MH7-258	GEMINI-MIXTER Hemostatic Forceps	delicate, full curved jaws	9" (22.9 cm)
MH7-259	GEMINI-MIXTER Hemostatic Forceps	delicate, full curved jaws	11" (27.9 cm)
MH14-48	LAHEY Gall Duct Forceps		7-1/2" (19.1 cm)
MH16-160	DOYEN Intestinal Forceps	straight, flexible blades with longitudinal serrations	9" (22.9 cm)
MH16-162	DOYEN Intestinal Forceps	curved, flexible blades with longitudinal serrations	9" (22.9 cm)
MH17-2600	JACOBSON Micro Mosquito Forceps	straight, extremely delicate	5" (12.7 cm)
MH17-2602	JACOBSON Micro Mosquito Forceps	curved, extremely delicate	5" (12.7 cm)
MH22-662	SCHNIDT Tonsil Hemostatic Forceps	slight curve, closed rings	7-1/2" (19.1 cm)
MH22-668	SAWTELL Tonsil Hemostatic Forceps	full curve, closed rings	7-1/2" (19.1 cm)
MH25-800	SAROT Intra-Thoracic Artery Forceps	long slightly curved jaws, 2-1/2" (6.4 cm) long	10" (25.4 cm)
MH25-814	MIXTER Thoracic Forceps	right angle jaws, longitudinal serrations	11" (27.9 cm)
MH25-836	KANTROWITZ Thoracic Forceps	delicate right angle jaws	7-1/2" (19.1 cm)
MH25-837	KANTROWITZ Thoracic Forceps	delicate right angle jaws	9-1/2" (24.1 cm)



MH7-255 to
MH7-259



MH14-48



MH16-160
MH16-162



MH17-2600



MH22-662



MH22-668



MH25-800



MH25-814



MH25-836
MH25-837

Hemostatic & Specialty Forceps

REF	Description	Type	Length
MH30-1025	JACOBS Forceps	straight, serrated jaws, 2 x 2 teeth	8-1/2" (21.6 cm)
MH30-1700	HEANEY Forceps	heavy pattern, single tooth, curved	8-1/4" (21 cm)
MH30-1710	HEANEY Forceps	heavy pattern, double tooth, curved	8-1/4" (21 cm)
MH30-1716	HEANEY-BALLENTINE Forceps	longitudinal serration, single tooth, curved	8-1/4" (21 cm)
MH30-1718	BALLENTINE Forceps	longitudinal serration, single tooth, straight	8-1/2" (21.6 cm)
MH27-990	MARTIN Cartilage Clamp	-	7" (17.8 cm)
MH27-1016	Tendon Pulling Forceps	curved shaft, alligator type	5" (12.7 cm)



MH30-1025

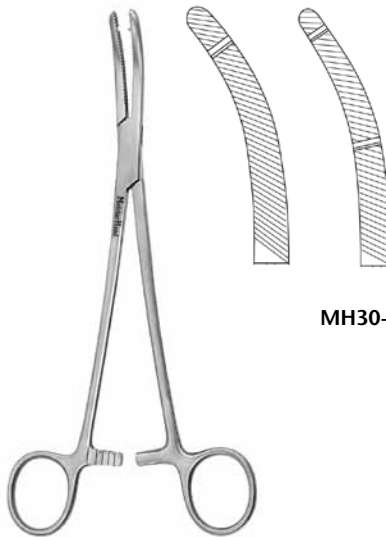

MH30-1700

MH30-1710

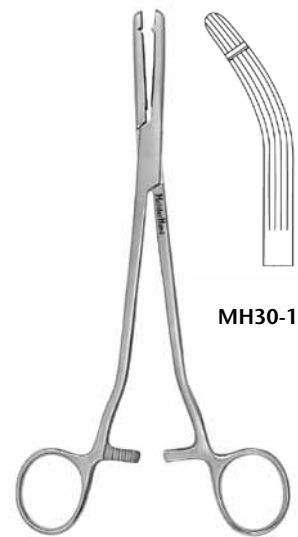

MH30-1716

MH30-1718



MH27-990



MH27-1016

Towel Clamps & Sponge Forceps

REF	Description	Type	Length
MH7-504	BACKHAUS Towel Clamp	-	4" (10.2 cm)
MH7-506	BACKHAUS Towel Clamp	-	5-1/4" (13.3 cm)
MH7-514	LORNA Non-Perforating Towel Forceps	-	4" (10.2 cm)
MH7-515	LORNA Non-Perforating Towel Forceps	-	5-1/4" (13.3 cm)
MH7-516	PEERS Towel Clamp	non-perforating jaws	5-3/4" (14.6 cm)
MH7-600	FOERSTER Sponge Forceps	straight, serrated jaws	9-1/2" (24.1 cm)
MH7-602	FOERSTER Sponge Forceps	straight, smooth jaws	9-1/2" (24.1 cm)
MH7-604	FOERSTER Sponge Forceps	straight, serrated jaws	7" (17.8 cm)
MH7-610	FOERSTER Sponge Forceps	curved, serrated jaws	9-1/2" (24.1 cm)
MH7-614	FOERSTER Sponge Forceps	curved, serrated jaws	7" (17.8 cm)
MH7-622	BOZEMAN Sponge Forceps	double curved	10-1/2" (26.7 cm)



MH7-504
MH7-506

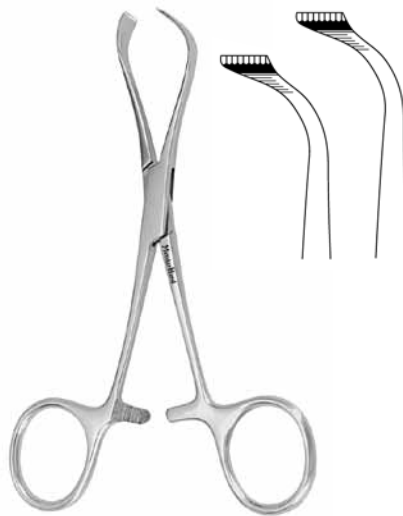

MH7-514
MH7-515



MH7-516



MH7-602

MH7-610
MH7-614

MH7-600
MH7-604

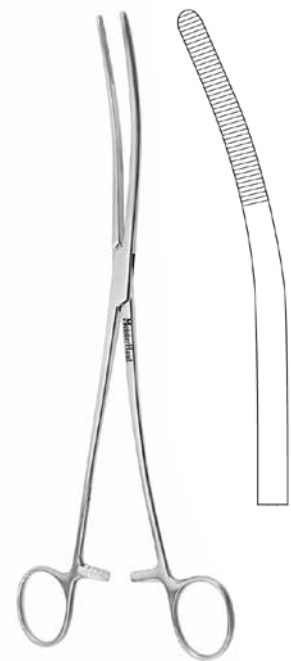

MH7-622

Needle Holders - Tungsten Carbide

REF	Description	Type	Length
MH8-4TC	DERF Needle Holder	serrated, tungsten carbide jaws	4-3/4" (12.1cm)
MH8-6TC	WEBSTER Needle Holder	with smooth jaws, standard pattern, delicate, tungsten carbide jaws	5-1/4" (13.3 cm)
MH8-8A-TC	HALSEY Needle Holder	serrated, tungsten carbide jaws	5" (12.7 cm)
MH8-15TC	OLSEN-HEGAR Needle Holder	with suture scissors, serrated, tungsten carbide jaws	5-1/2" (14 cm)
MH8-16TC	OLSEN-HEGAR Needle Holder	with suture scissors, serrated, tungsten carbide jaws	6-1/2" (16.5 cm)
MH8-17TC	OLSEN-HEGAR Needle Holder	with suture scissors, serrated, tungsten carbide jaws	7-1/2" (19.1 cm)

*For easy identification, MeisterHand® tungsten carbide needle holders have two gold-plated finger rings



MH8-4TC



MH8-6TC



MH8-8A-TC



MH8-15TC
MH8-16TC
MH8-17TC

Needle Holders - Tungsten Carbide

REF	Description	Type	Length
MH8-40TC	BAUMGARTNER Needle Holder	serrated, tungsten carbide jaws	5-1/2" (14 cm)
MH8-42TC	MAYO-HEGAR Needle Holder	serrated, tungsten carbide jaws	5" (12.7 cm)
MH8-44TC	MAYO-HEGAR Needle Holder	serrated, tungsten carbide jaws	6-1/4" (15.9 cm)
MH8-46TC	MAYO-HEGAR Needle Holder	serrated, tungsten carbide jaws	7" (17.8 cm)
MH8-48TC	MAYO-HEGAR Needle Holder	serrated, tungsten carbide jaws	8" (20.3 cm)
MH8-50TC	CRILE-WOOD Needle Holder	serrated, tungsten carbide jaws	6" (15.2 cm)
MH8-51TC	CRILE-WOOD Needle Holder	serrated, tungsten carbide jaws	7" (17.8 cm)
MH8-52TC	CRILE-WOOD Needle Holder	serrated, tungsten carbide jaws	8" (20.3 cm)

*For easy identification, MeisterHand® tungsten carbide needle holders have two gold-plated finger rings



MH8-40TC



**MH8-42TC to
MH8-48TC**



**MH8-50TC to
MH8-52TC**

Needle Holders - Tungsten Carbide

REF	Description	Type	Length
MH8-100TC	HEANEY Needle Holder	curved, serrated, tungsten carbide jaws	8-1/2" (21.6 cm)
MH8-101TC	RYDER Needle Holder	serrated, tungsten carbide jaws	5" (12.7 cm)
MH8-103TC	RYDER Needle Holder	serrated, tungsten carbide jaws	6" (15.2 cm)
MH8-104TC	RYDER Needle Holder	serrated, tungsten carbide jaws	7" (17.8 cm)
MH8-105TC	RYDER Needle Holder	serrated, tungsten carbide jaws	8" (20.3 cm)
MH8-130TC	MAYO-HEGAR (MASSON) Needle Holder	serrated, tungsten carbide jaws	10-1/2" (26.7 cm)
MH18-1828TC	CASTROVIEJO Needle Holder	smooth, straight, with lock, tungsten carbide jaws	5-1/2" (14 cm)

*For easy identification, MeisterHand® tungsten carbide needle holders have two gold-plated finger rings

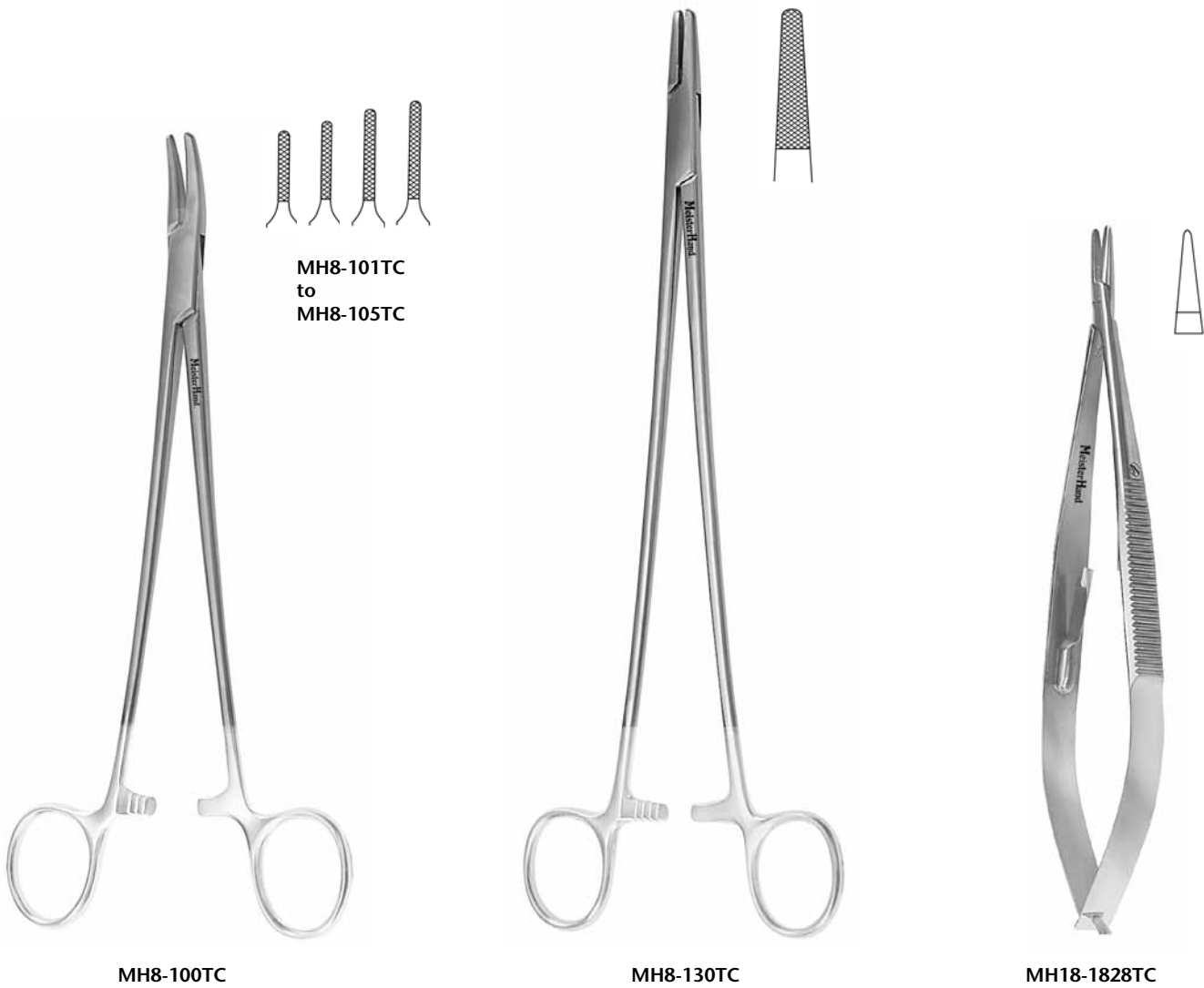

Needle Holders

REF	Description	Type	Length
MH8-2	COLLIER Needle Holder	fenestrated jaws	5" (12.7 cm)
MH8-4	DERF Needle Holder	-	4-3/4" (12.1 cm)
MH8-6	WEBSTER Needle Holder	delicate, smooth jaws, standard pattern	5" (12.7 cm)
MH8-8	HALSEY Needle Holder	smooth jaws	5" (12.7 cm)
MH8-14	OLSEN-HEGAR Needle Holder	with suture scissors, serrated jaws, extra delicate	4-3/4" (12.1 cm)
MH8-15	OLSEN-HEGAR Needle Holder	with suture scissors, serrated jaws	5-1/2" (14 cm)
MH8-16	OLSEN-HEGAR Needle Holder	with suture scissors, serrated jaws	6-1/2" (16.5 cm)
MH8-17	OLSEN-HEGAR Needle Holder	with suture scissors, serrated jaws	7-1/4" (18.4 cm)
MH8-20	CONVERSE Needle Holder	longitudinal serrations	4-1/4" (10.8 cm)
MH8-22	BROWN Needle Holder	convex jaws, fine serrations	5-1/4" (13.3 cm)



MH8-2



MH8-4



MH8-6



MH8-8



MH8-14



MH8-15
MH8-16
MH8-17

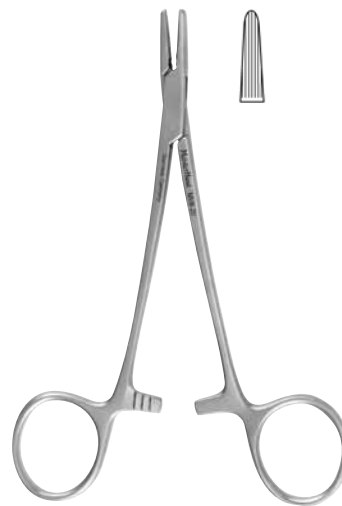

MH8-20



MH8-22

Needle Holders

REF	Description	Length
MH8-40	BAUMGARTNER Needle Holder	5-1/2" (14 cm)
MH8-42	MAYO-HEGAR Needle Holder	5" (12.7 cm)
MH8-44	MAYO-HEGAR Needle Holder	6" (15.2 cm)
MH8-46	MAYO-HEGAR Needle Holder	7" (17.8 cm)
MH8-48	MAYO-HEGAR Needle Holder	8" (20.3 cm)
MH8-50	CRILE-WOOD Needle Holder	6" (15.2 cm)
MH8-51	CRILE-WOOD Needle Holder	7" (17.8 cm)
MH8-52	CRILE-WOOD Needle Holder	8" (20.3 cm)



MH8-40

MH8-42 to
MH8-48MH8-50 to
MH8-52

Needle Holders

REF	Description	Type	Length
MH8-100	HEANEY Needle Holder	curved jaws	8-1/2" (21.6 cm)
MH8-130	MAYO-HEGAR (MASSON) Needle Holder	-	10-1/2" (26.7 cm)
MH18-1828	CASTROVIEJO Needle Holder	straight, with lock	5-1/2" (14 cm)
MH18-1832	CASTROVIEJO Needle Holder	curved, with lock	5-1/2" (14 cm)



MH8-100



MH8-130



**MH18-1828
MH18-1832**

Bone Forceps & Clamps

REF	Description	Type	Length
MH21-626	RUSKIN Bone Splitting Forceps	straight	6" (15.2 cm)
MH21-627	RUSKIN Bone Splitting Forceps	curved	6" (15.2 cm)
MH25-384	RUSKIN Bone Cutting Forceps	straight, standard blades	7-1/2" (19.1 cm)
MH25-390	STILLE-LISTON Bone Cutting Forceps	straight	10-3/4" (27.3 cm)
MH25-392	STILLE-LISTON Bone Cutting Forceps	curved	10-3/4" (27.3 cm)
MH25-396	STILLE-HORSLEY Bone Cutting Forceps	angled blades	10-1/2" (26.7 cm)
MH27-4	KERN Bone Holding Forceps	standard size, with ratchet	9-1/2" (24.1 cm)
MH27-7	KERN Bone Holding Forceps	petite size, with ratchet	6" (15.2 cm)
MH27-16	LEWIN Bone Holding Forceps	serrated jaws	7" (17.8 cm)
MH27-30	LOWMAN Bone Clamp	calibrated in 1/8" (.32 cm), 1 x 2 prong jaws 3/4" (1.9 cm) wide	5" (12.7 cm)
MH27-32	LOWMAN Bone Clamp	calibrated in 1/8" (.32 cm), 1 x 2 prong jaws 1" (2.5 cm) wide	7" (17.8 cm)
MH27-34	LOWMAN Bone Clamp	calibrated in 1/8" (.32 cm), 1 x 2 prong jaws 1-1/4" (3.2 cm) wide	8" (20.3 cm)



MH21-626



MH21-627



MH25-384



MH25-390



MH25-392



MH25-396



MH27-4
MH27-7

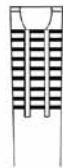

MH27-16



MH27-30 to
MH27-34

Alligator Ear Forceps

REF	Description	Type	Length
MH19-2081	Micro Alligator Ear Forceps	serrated jaws, 0.6 mm wide	3-1/4" (8.3 cm) shaft
MH19-2110	Micro Alligator Ear Forceps	oval cup jaws, 0.8 mm wide	3-1/4" (8.3 cm) shaft
MH19-410	HARTMAN Ear Forceps	delicate serrated jaws, 2.5 mm x 6 mm	5" (12.7 cm)
MH19-411	HARTMAN Alligator Ear Forceps	serrated jaws	5-1/2" (14 cm)
MH19-434	HARTMAN-NOYES Alligator Ear Forceps	serrated jaws	3-1/4" (8.3 cm) shaft
MH20-140	NOYES Alligator Forceps	serrated jaws	5-1/2" (14 cm)
MH20-142	NOYES Alligator Forceps	serrated jaws	6-1/2" (16.5 cm)



MH19-2080



MH19-2110



MH19-410



MH19-411



MH19-434

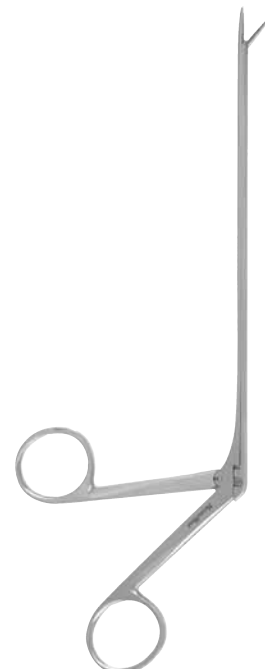

MH20-140
MH20-142

Retractors

REF	Description	Type	Length
MH11-2	JANSEN Retractor	spread 3" (7.6 cm), 3 x 3 blunt prongs 10 mm deep, standard model	4-1/4" (10.8 cm)
MH11-12	ALM Retractor	spread 2-1/4" (5.7 cm), prongs 1/8" (.32cm) deep	2-3/4" (7 cm)
MH11-13	ALM Retractor	spread 3" (7.6 cm), prongs 1/2" (1.3 cm) deep	3-7/8" (9.8 cm)
MH11-14	HEISS Self-Retaining Cross Action Retractor	sharp prongs	4" (10.2 cm)
MH11-16	HEISS Self-Retaining, Cross Action Retractor	blunt prongs	4" (10.2 cm)
MH11-22	GREEN Retractor		8-1/2" (21.6 cm)
MH11-73	RAGNELL Retractor	double end 3 mm x 8 mm and 5 mm x 15mm blades, delicate	6" (15.2 cm)
MH11-74	SENN Retractor	sharp, double end	6-3/8" (16.2 cm)
MH11-76	SENN Retractor	blunt, double end	6-3/8" (16.2 cm)
MH11-78	CRILE Retractor	double end 3 mm x 11 mm and 6 mm x 20 mm blades	4-1/2" (11.4 cm)



MH11-2



MH11-12
MH11-13



MH11-14



MH11-16



MH11-22



MH11-73

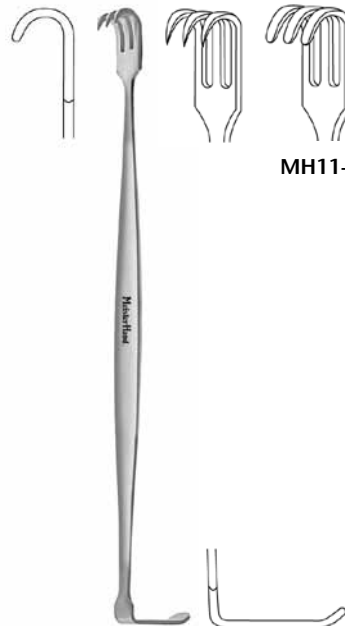

MH11-76

MH11-74



MH11-78

Retractors

REF	Description	Type	Length
MH11-102	CUSHING Vein Retractor	blade 11 mm x 13 mm	9" (22.9 cm)
MH11-110	FARABEUZ Retractor	double end, set of 2	6" (15.2 cm)
MH11-114	PARKER Retractor	double end, set of 2	5" (12.7 cm)
MH11-120	GOELET Retractor	double end	7-1/2" (19.1 cm)
MH11-122	U.S. ARMY Retractor	double end, set of 2	8-1/2" (21.6 cm)
MH11-132	Ribbon Retractor	malleable	1" (2.5 cm) x 13" (33 cm)
MH11-136	Ribbon Retractor	malleable	1-1/2" (3.8 cm) x 13" (33 cm)
MH11-140	Ribbon Retractor	malleable	2" (5.1 cm) x 13" (33 cm)
MH11-144	Ribbon Retractor	malleable, petite	5/8" (1.6 cm) x 8" (20.3 cm)
MH11-146	Ribbon Retractor	malleable, petite	1" (2.5 cm) x 8" (20.3 cm)
MH11-162	LANGENBECK Retractor	blade 3/8" (1 cm) x 1-1/2" (3.8 cm)	8" (20.3 cm)
MH11-164	LANGENBECK Retractor	blade 1/2" (1.3 cm) x 1-1/2" (3.8cm)	8" (20.3 cm)
MH11-166	LANGENBECK Retractor	blade 5/8" (1.6 cm) x 1-1/2" (3.8cm)	8" (20.3 cm)



MH11-102



MH11-110



MH11-114



MH11-120



MH11-122



MH11-132 to
MH11-146



MH11-162 to
MH11-166

Retractors

REF	Description	Type	Length
MH11-180	HEANEY Retractor	blade 1" (2.5 cm) x 1-3/4" (4.4 cm)	10-1/2" (26.7 cm)
MH11-182	HEANEY Retractor	blade 1-1/8" (2.8 cm) x 2-7/8" (7.3 cm)	10-1/2" (26.7 cm)
MH11-184	HEANEY Retractor	blade 1-1/8" (2.8 cm) x 3-1/4" (8.3 cm)	10-1/2" (26.7 cm)
MH11-185	HEANEY-SIMON Retractor	blade 1" (2.5 cm) x 4-1/2" (11.4 cm)	11-1/2" (29.2 cm)
MH11-202	DEAVER Retractor	1" (2.5 cm)	12" (30.5 cm)
MH11-206	DEAVER Retractor	1-1/2" (3.8 cm)	12" (30.5 cm)
MH11-208	DEAVER Retractor	2" (5.1 cm)	12" (30.5 cm)
MH11-210	DEAVER Retractor	3" (7.6 cm)	12" (30.5 cm)
MH11-219	DEAVER Retractor	petite, 3/4" (1.9 cm)	7" (17.8 cm)
MH11-220	DEAVER Retractor	petite, 7/8" (2.2 cm)	8" (20.3 cm)
MH11-240	MEYERDING Retractor	large blade 3-1/2" (8.9 cm) x 2" (5.1 cm)	9-1/2" (24.1 cm)
MH11-242	MEYERDING Retractor	medium blade 3" (7.6 cm) x 1" (2.5 cm)	9-1/2" (24.1 cm)
MH11-244	MEYERDING Retractor	small blade 2" (5.1 cm) x 5/8" (1.6 cm)	9-1/2" (24.1 cm)



MH11-180 to
MH11-184

MH11-185

MH11-202

MH11-206 to
MH11-220

MH11-240 to
MH11-244

Retractors

REF	Description	Type	Length
MH11-246	RICHARDSON Retractor	loop handle, 1" (2.5 cm) x 3/4" (1.9 cm)	10" (25.4 cm)
MH11-247	RICHARDSON Retractor	loop handle, 1-1/4" (3 cm) x 1" (2.5 cm)	10" (25.4 cm)
MH11-248	RICHARDSON Retractor	loop handle, 1-1/2" (3 cm) x 1-1/2" (3.8 cm)	10" (25.4 cm)
MH11-249	RICHARDSON Retractor	loop handle, 2" (5.1 cm) x 3/4" (1.9 cm)	10" (25.4 cm)
MH11-260	RICHARDSON-EASTMAN Retractor	double end, set of 2	
MH11-260-A	RICHARDSON-EASTMAN Retractor	large size, double end	11" (27.9 cm)
MH11-260-B	RICHARDSON-EASTMAN Retractor	small size, double end	10" (25.4 cm)
MH11-266	KELLY Retractor	loop handle, 2" (5.1 cm) x 1-1/2" (3.8 cm)	9-3/4" (24.8 cm)
MH11-268	KELLY Retractor	loop handle, 3" (7.6 cm) x 2-1/2" (6.4 cm)	9-3/4" (24.8 cm)
MH11-269	KELLY Retractor	loop handle, 3-1/2" (8.9 cm) x 2-3/4" (7 cm)	9-3/4" (24.8 cm)
MH11-314	HARRINGTON Retractor	blade 2-1/2" (6.4 cm) wide	12" (30.5 cm)
MH11-316	HARRINGTON Retractor	blade 1-1/2" (3.8 cm) wide	12" (30.5 cm)



MH11-246 to
MH11-249



MH11-260 to
MH11-260-B



MH11-266 to
MH11-269



MH11-314
MH11-316

Retractors

REF	Description	Type	Length
MH11-530	VOLKMAN Retractor	2 prongs, sharp, ring handle	8-1/2" (21.6 cm)
MH11-532	VOLKMAN Retractor	3 prongs, sharp, ring handle	8-1/2" (21.6 cm)
MH11-534	VOLKMAN Retractor	4 prongs, sharp, ring handle	8-1/2" (21.6 cm)
MH11-536	VOLKMAN Retractor	6 prongs, sharp, ring handle	8-1/2" (21.6 cm)
MH11-538	VOLKMAN Retractor	2 prongs, blunt, ring handle	8-1/2" (21.6 cm)
MH11-540	VOLKMAN Retractor	3 prongs, blunt, ring handle	8-1/2" (21.6 cm)
MH11-542	VOLKMAN Retractor	4 prongs, blunt, ring handle	8-1/2" (21.6 cm)
MH11-544	VOLKMAN Retractor	6 prongs, blunt, ring handle	8-1/2" (21.6 cm)
MH11-580	BENNETT Tibia Retractor	blade 1-3/4" (4.4 cm) wide	8-1/2" (21.6 cm)
MH11-582	BENNETT Tibia Retractor	blade 2-1/2" (6.4 cm) wide	9-1/2" (24.1 cm)
MH11-590	HIBBS Retractor	blade 1" (2.5 cm) x 3" (7.6 cm) deep	9-1/4" (23.5 cm)

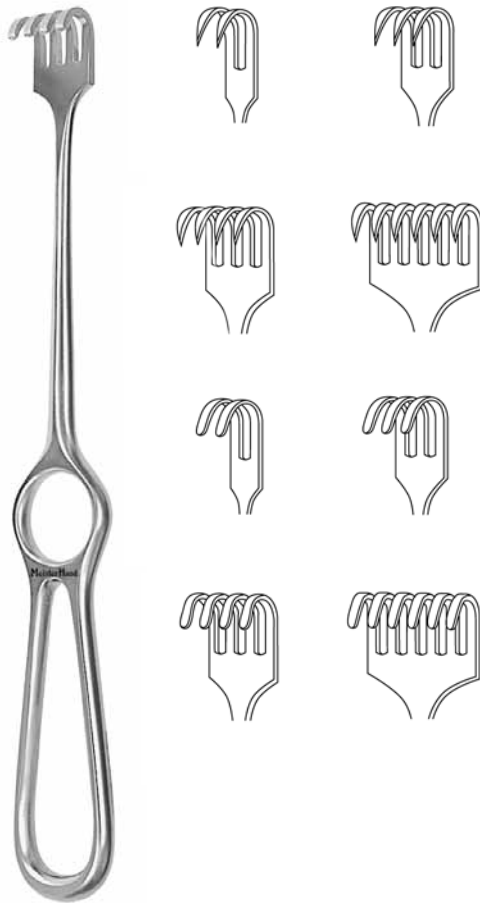

MH11-530 to
MH11-544



MH11-580
MH11-582



MH11-590

Retractors

REF	Description	Type	Length
MH11-364	GELPI Retractor	mini, with grip lock	3-1/2" (8.9cm)
MH11-365	GELPI Retractor	petite, with grip lock	5-1/2" (14 cm)
MH11-366	GELPI Retractor	with grip lock	7-1/2" (19.1 cm)
MH11-600	WEITLANER Retractor	sharp, 2 x 3 teeth	4" (10.2 cm)
MH11-602	WEITLANER Retractor	blunt, 2 x 3 teeth	4" (10.2 cm)
MH11-608	WEITLANER Retractor	sharp, 3 x 4 teeth	5-1/2" (14 cm)
MH11-610	WEITLANER Retractor	blunt, 3 x 4 teeth	5-1/2" (14 cm)
MH11-614	WEITLANER Retractor	sharp, 3 x 4 teeth	6-1/2" (16.5 cm)
MH11-616	WEITLANER Retractor	blunt, 3 x 4 teeth	6-1/2" (16.5 cm)
MH11-630-BL	BECKMAN-WEITLANER Retractor	blunt, 3 x 4 teeth with hinge blades	5-1/2" (14 cm)
MH11-630-SH	BECKMAN-WEITLANER Retractor	sharp, 3 x 4 teeth with hinge blades	5-1/2" (14 cm)
MH11-684	BECKMAN-ADSON Retractor	hinged, sharp, 4 x 4 teeth, 3/4" (1.9 cm) x 1" (2.5cm)	12-1/2" (31.8 cm)
MH11-700	ADSON Retractor	straight arms, sharp, 4 x 4 teeth 3/4" (1.9cm) x 3/4" (1.9 cm)	7-1/2" (19.1 cm)
MH11-702	ADSON Retractor	angled arms, sharp, 4 x 4 teeth 3/4" (1.9cm) x 3/4" (1.9 cm)	7-1/2" (19.1 cm)



MH11-364 to
MH11-366



MH11-600 to
MH11-602



MH11-608 to
MH11-610



MH11-614
MH11-616



MH11-630-BL
MH11-630-SH



MH11-684



MH11-700
MH11-702

Retractors

REF	Description	Type	Length
MH18-100	KNAPP (ROLLET) Retractor	with 4 sharp prongs	5-1/4" (13.3 cm)
MH18-102	KNAPP Retractor	with 4 blunt prongs	5-1/4" (13.3 cm)
MH18-110	DESMARRES Lid Retractor	size 1, 11 mm	5-1/2" (14 cm)
MH18-112	DESMARRES Lid Retractor	size 2, 13 mm	5-1/2" (14 cm)
MH18-114	DESMARRES Lid Retractor	size 3, 15 mm	5-1/2" (14 cm)
MH18-116	DESMARRES Lid Retractor	size 4, 17 mm	5-1/2" (14 cm)
MH21-145	COTTLE Retractor	right ball tip	6-1/2" (16.5 cm)
MH21-146	COTTLE Retractor	left ball tip	6-1/2" (16.5 cm)
MH21-148	FOMON Retractor	two prongs with ball tips, 11 mm wide	6-1/2" (16.5 cm)
MH21-165	COTTLE Knife Guide and Retractor	double ended, ball tip prongs, 10 mm wide, slotted hook, 5 mm wide	8" (20.3 cm)
MH21-188	AUFRICHT Retractor-Speculum	solid blade, 45 mm long	6-1/2" (16.5 cm)
MH22-854	HURD Dissector & Pillar Retractor	standard pattern, 10.2 mm x 13.9 mm blade	9" (22.9 cm)
MH23-1049	JACKSON Retractor	double ended, 2 blunt prongs, 5/16" (2.4 cm) wide and solid blade 3/8" (1 cm) wide	7" (17.8 cm)

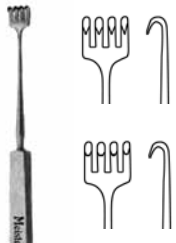

MH18-102

MH18-100

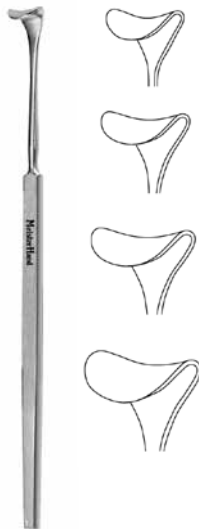

MH18-110
MH18-116

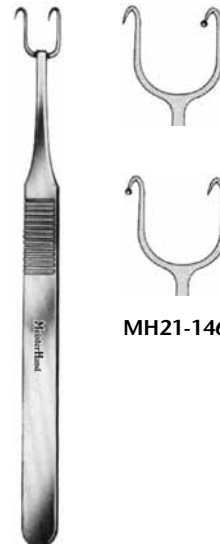

MH21-146

MH21-145

MH21-148



MH21-165



MH21-188



MH22-854



MH23-1049

Retractors

REF	Description	Type	Length
MH27-213	MINI-HOHMANN Retractor	blade 6 mm wide	6-1/4" (15.9 cm)
MH27-214	MINI-HOHMANN Retractor	blade 8 mm wide	6-1/4" (15.9 cm)
MH27-215	HOHMANN Retractor	blade 10 mm wide	9-1/4" (23.5 cm)
MH27-216	HOHMANN Retractor	blade 18 mm wide	9-1/4" (23.5 cm)
MH27-217	HOHMANN Retractor	blade 25 mm wide	9-1/4" (23.5 cm)
MH27-218	HOHMANN Retractor	blade 43 mm wide	9-1/4" (23.5 cm)
MH27-219	HOHMANN Retractor	blade 70 mm wide	9-3/4" (24.8 cm)
MH28-68	HILL-FERGUSON Retractor	small blade 2.2 cm x 6.4 cm	8-1/2" (21.6 cm)
MH28-69	HILL-FERGUSON Retractor	large blade 3 cm x 7.6 cm	8-3/4" (22.3 cm)
MH30-395	DOYEN Retractor	blade 1-3/4" (4.4 cm) x 2-1/2" (6.4 cm)	9" (22.9 cm)
MH30-406	DOYEN Retractor	blade 2-1/8" (5.4 cm) x 3" (7.6 cm)	9" (22.9 cm)
MH30-415	DOYEN Retractor	blade 2-1/4" (5.7 cm) x 3-1/2" (8.9 cm)	9" (22.9 cm)



MH27-213
MH27-214

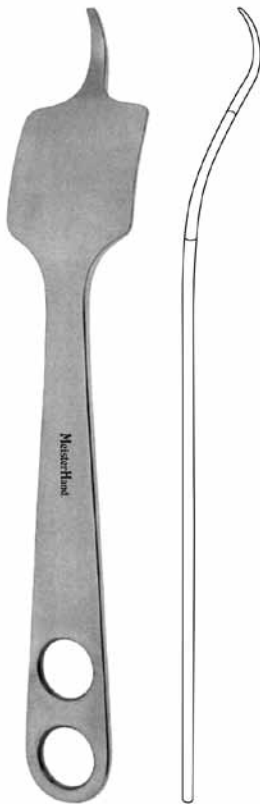

MH27-215 to
MH27-219



MH28-68



MH28-69



MH30-395
MH30-406
MH30-415

Specula

REF	Description	Type	Length
MH18-35	BARRAQUER Eye Speculum	large blades 15 mm wide	1-3/4" (4.4 cm)
MH18-36	BARRAQUER Eye Speculum	small blades 10 mm wide	1-3/4" (4.4 cm)
MH20-2	VIENNA Speculum	large size, standard pattern	5-3/4" (14.6 cm)
MH20-3	VIENNA Speculum	medium size, standard pattern	5-3/4" (14.6 cm)
MH20-4	VIENNA Speculum	small size, standard pattern	5-3/4" (14.6 cm)
MH20-12	TIECK-HALLE Small Speculum	small size	5-1/2" (14 cm)
MH20-24	BECKMAN Speculum	angled on side	6" (15.2 cm)
MH20-28	KILLIAN Speculum	2" (5.2 cm) long blades, with set screw	6" (15.2 cm)
MH20-29	KILLIAN Speculum	2-1/2" (6.4 cm) long blades, with set screw	6" (15.2 cm)
MH20-30	KILLIAN Speculum	3" (7.6 cm) long blades, with set screw	6" (15.2 cm)
MH20-32	KILLIAN Speculum	3-1/2" (8.9 cm) long blades, with set screw	6" (15.2 cm)

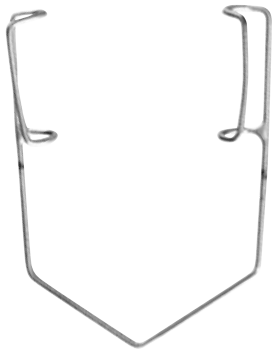

MH18-35



MH20-2



MH20-3



MH20-4



MH18-36



MH20-12



MH20-24



MH20-28 to
MH20-32

Hooks

REF	Description	Type	Length
MH18-412	TYRELL Hook	sharp	5" (12.7 cm)
MH18-414	TYRELL Hook	blunt	5" (12.7 cm)
MH18-416	GUTHRIE Fixation Hook	sharp double prongs 1.5 mm wide	5" (12.7 cm)
MH18-440	STEVENS Tenotomy Hook	right angle 5 mm deep	5" (12.7 cm)
MH18-446	JAMESON Strabismus Hook	10 mm deep	5" (12.7 cm)
MH18-450	VON GRAEFE Strabismus Hook	small size 8 mm long	5-1/4" (13.3 cm)
MH18-452	VON GRAEFE Strabismus Hook	medium size 10 mm long	5-1/2" (14 cm)
MH18-454	VON GRAEFE Strabismus Hook	large size 11 mm long	5-3/4" (14.6 cm)
MH19-220	DAY Ear Hook	small size	6-1/2" (16.5 cm)
MH19-222	DAY Ear Hook	large size	6-1/2" (16.5 cm)
MH21-88	GILLIES (CONVERSE) Skin Hook	large	7" (17.8 cm)
MH21-89	GILLIES (CONVERSE) Skin Hook	small	7" (17.8 cm)
MH21-90	COTTLE Skin Hook	small, shallow curve	5-1/2" (14 cm)
MH21-92	COTTLE Skin Hook	small, deep curve	5-1/2" (14 cm)
MH21-94	COTTLE Skin Hook	large, deep curve	5-1/2" (14 cm)

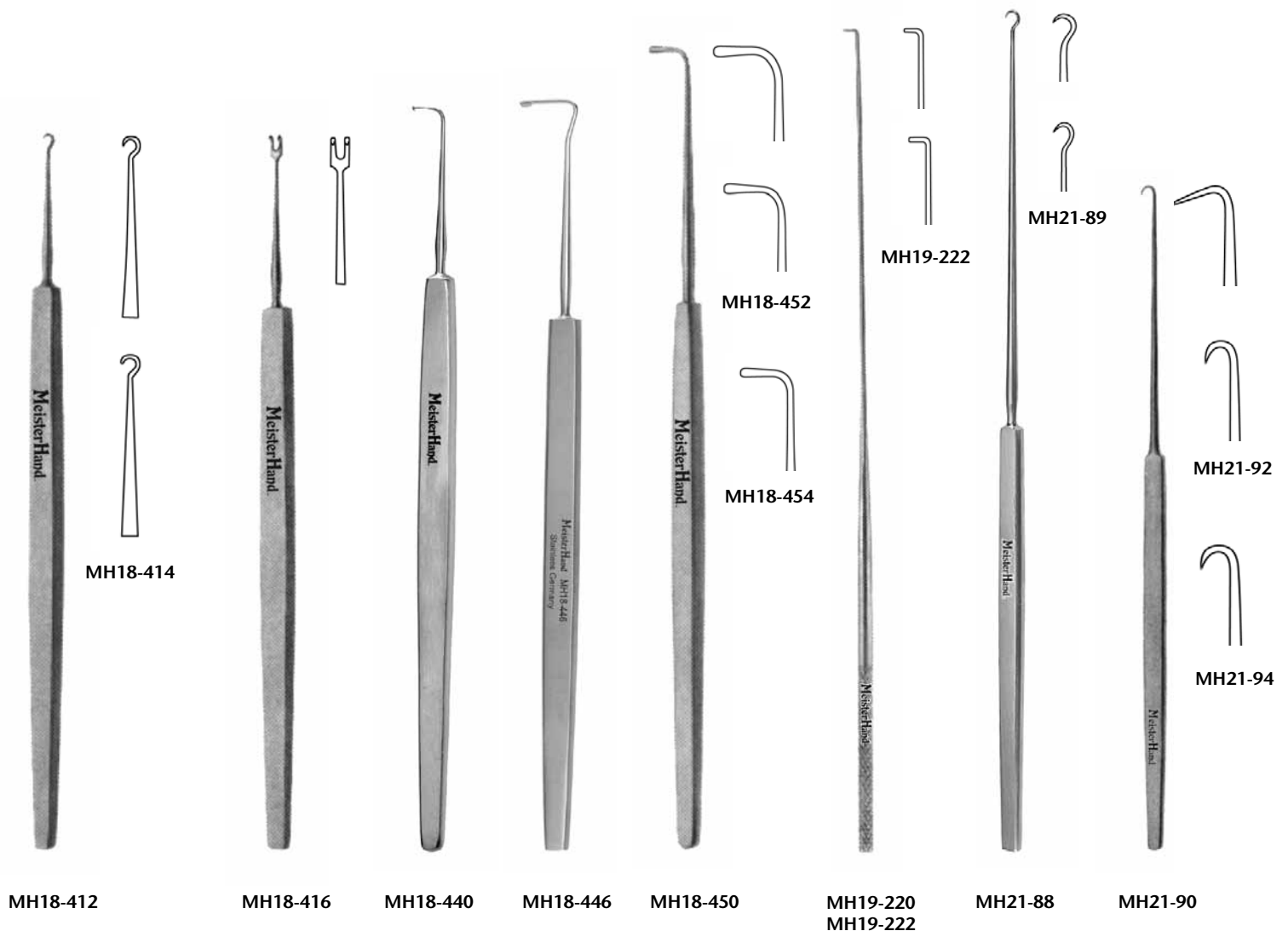

Hooks

REF	Description	Type	Length
MH21-144	COTTLE Double Hook	two sharp prongs, 12 mm wide	5-1/2" (14 cm)
MH21-145	COTTLE Double Hook	right ball tip	5-1/2" (14 cm)
MH21-146	COTTLE Double Hook	left ball tip	5-1/2" (14 cm)
MH21-152	Skin Hook	sharp prong, 2 mm diameter	4-3/4" (12.1 cm)
MH21-153	JOSEPH Hook	one sharp prong	6-1/4" (15.9 cm)
MH21-154	JOSEPH Double Hook	two sharp prongs, 2 mm wide	6-1/4" (15.9 cm)
MH21-156	JOSEPH Double Hook	two sharp prongs, 5 mm wide	6-1/4" (15.9 cm)
MH21-158	JOSEPH Double Hook	two sharp prongs, 7 mm wide	6-1/4" (15.9 cm)
MH21-160	JOSEPH Double Hook	two sharp prongs, 10 mm wide	6-1/4" (15.9 cm)
MH23-1050	JACKSON Tenaculum Hook & Retractor	sharp points	5-3/4" (14.6 cm)
MH23-1051	NEWS Hook	single sharp prong	6" (15.2 cm)

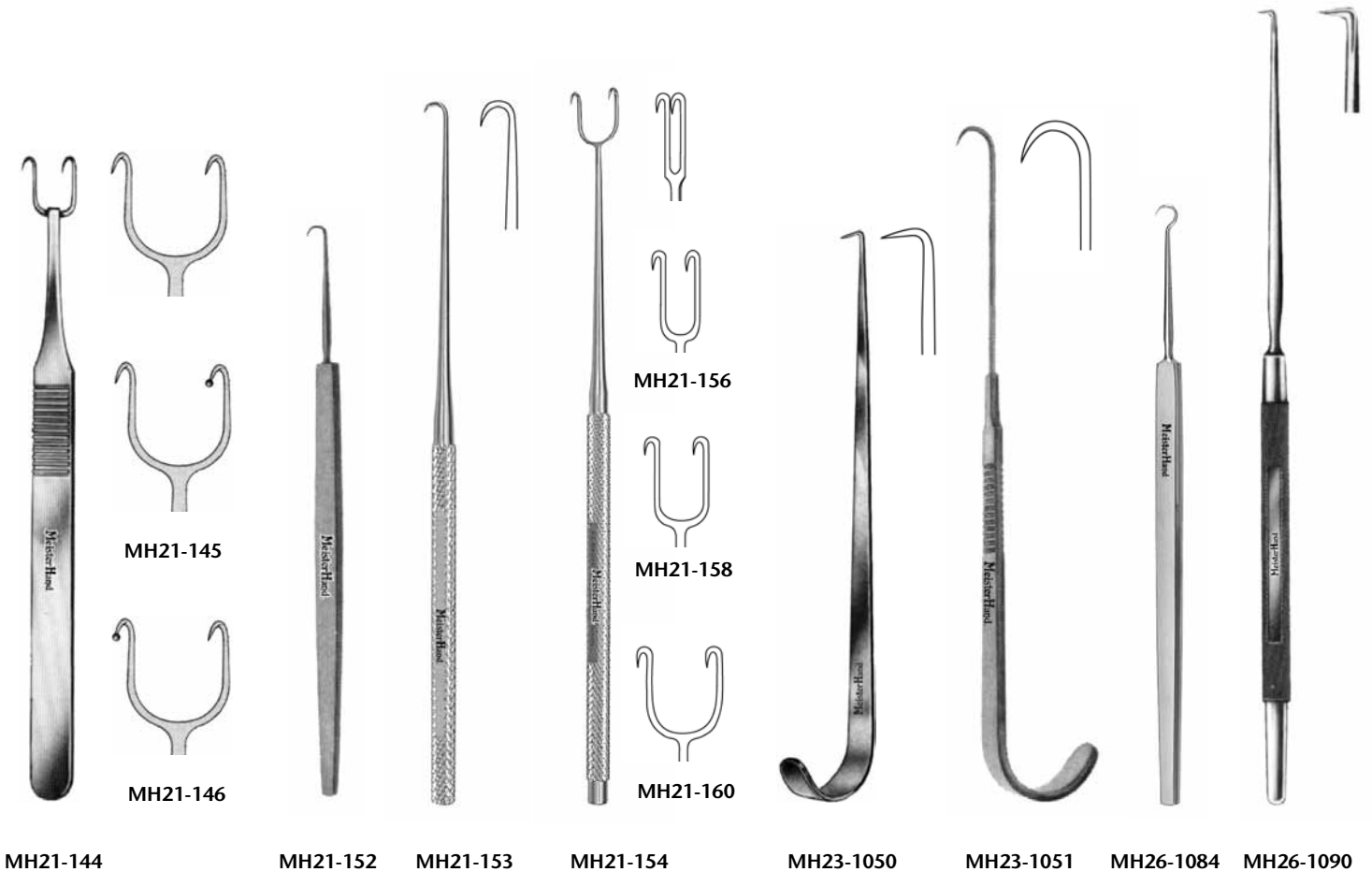

Rasps

REF	Description	Type	Length
MH21-330	JOSEPH Rasp	fine cross serrations	6-1/4" (15.9 cm)
MH21-338	COTTLE Rasp	backward cutting	8" (20.3 cm)
MH21-342	MALTZ Nasal Rasp	backward cutting	7" (17.8 cm)
MH21-346	AUFRICHT Glabella Rasp	curved blade, forward cutting	8-1/4" (21 cm)
MH21-348	AUFRICHT Glabella Rasp	curved blade, backward cutting	8-1/4" (21 cm)
MH21-368	FOMON Rasp	double ended, 4-sided, fine & coarse, both in flat & convex	8-1/4" (21 cm)
MH21-369	FOMON Rasp	double ended, coarse teeth, flat & convex	8-1/4" (21 cm)
MH21-370	FOMON Rasp	double ended, fine teeth, flat & convex	8-1/4" (21 cm)
MH27-700	PUTTI Bone Rasp	flat ends, one side curved on flat, other one curved sideways	10-1/2" (26.7 cm)
MH27-702	PUTTI Bone Rasp	round and half-round tapered curved ends	12" (30.5 cm)



MH21-330



MH21-338



MH21-342

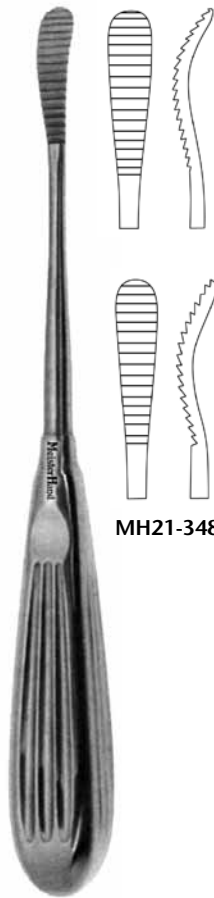

MH21-346

MH21-348



MH21-368 to
MH21-370



MH27-700



MH27-702

Suction Tubes

REF	Description	Type	Length
MH2-104SS	YANKAUER Suction Tube	with removable tip and tubing connection	11-3/4" (29.8 cm)
MH2-106SS	YANKAUER Suction Tube Tip only	Suction Tube (MH2-104SS)	-
MH2-109	YANKAUER Petite Suction Tube	with removable tip, delicate pattern	8-1/2" (21.6 cm)
MH2-110SS	ANDREWS-PYNCHON Suction Tube	delicate pattern	10" (25.4 cm)
MH10-310	POOLE Suction Tube	curved	23 French (7.6 mm)
MH10-312	POOLE Suction Tube	straight	30 French (9.9 mm)
MH19-570	FRAZIER Suction Tube	with finger cut-off, angled	6 French (2 mm)
MH19-572	FRAZIER Suction Tube	with finger cut-off, angled	7 French (2.3 mm)
MH19-573	FRAZIER Suction Tube	with finger cut-off, angled	8 French (2.6 mm)
MH19-574	FRAZIER Suction Tube	with finger cut-off, angled	9 French (3 mm)
MH19-575	FRAZIER Suction Tube	with finger cut-off, angled	10 French (3.3 mm)
MH19-576	FRAZIER Suction Tube	with finger cut-off, angled	11 French (3.6 mm)
MH19-577	FRAZIER Suction Tube	with finger cut-off, angled	12 French (4 mm)
MH19-580	BARON Suction Tube	with finger cut-off, working length 7.5 cm	3 French (1 mm)
MH19-582	BARON Suction Tube	with finger cut-off, working length 7.5 cm	5 French (1.7 mm)
MH19-584	BARON Suction Tube	with finger cut-off, working length 7.5 cm	7 French (2.3 mm)

Please refer to the reference section on page 536 for French conversions.

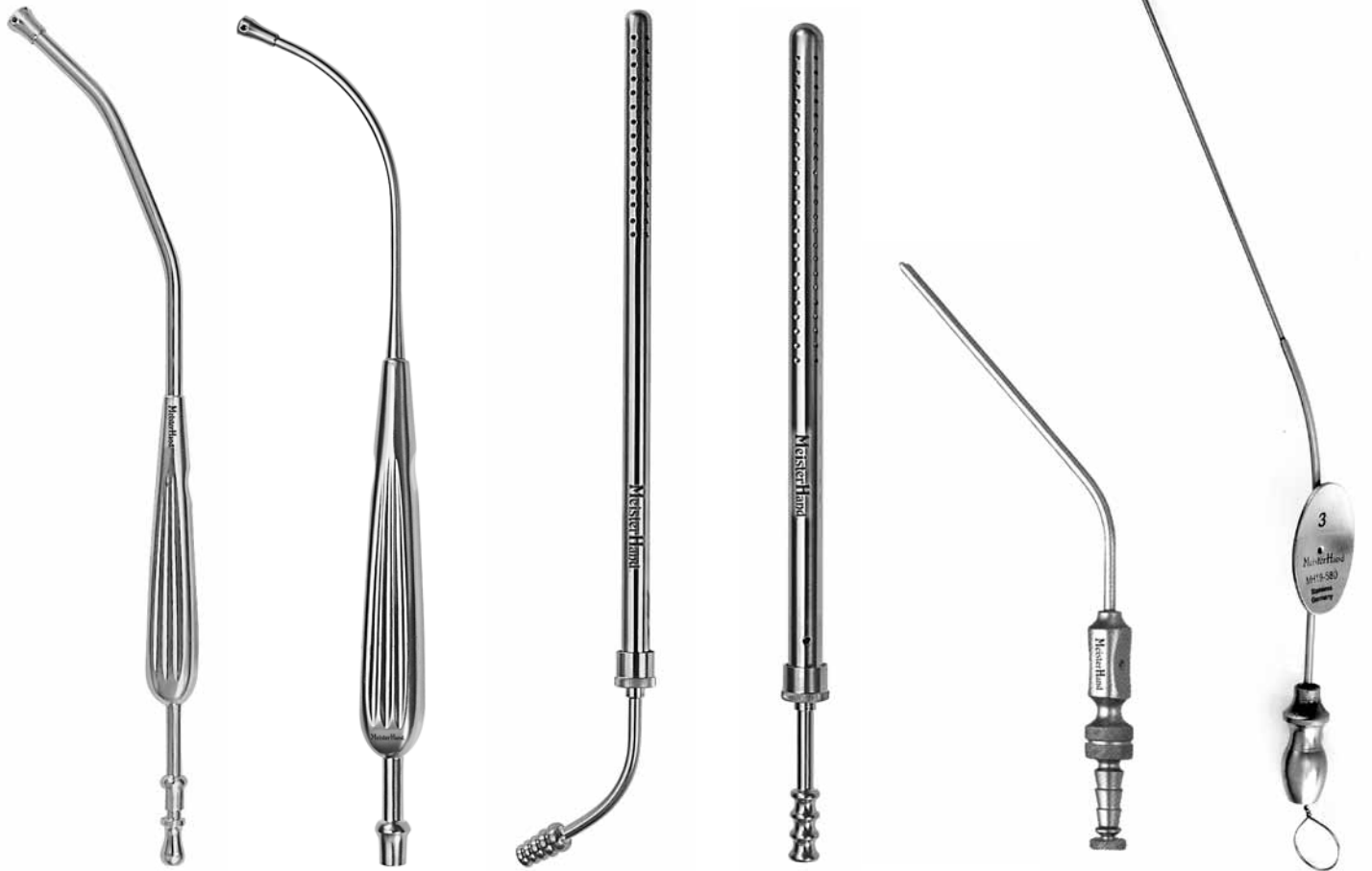

MH2-104SS
MH2-109

MH2-110SS

MH10-310

MH10-312

MH19-570 to
MH19-577

MH19-580 to
MH19-584

Ear Currettes & Loops

REF	Description	Type	Length
MH19-280	BUCK Ear Curette	straight, blunt, size 00	6-1/2" (16.5 cm)
MH19-282	BUCK Ear Curette	straight, blunt, size 0	6-1/2" (16.5 cm)
MH19-284	BUCK Ear Curette	straight, blunt, size 1	6-1/2" (16.5 cm)
MH19-286	BUCK Ear Curette	straight, blunt, size 2	6-1/2" (16.5 cm)
MH19-288	BUCK Ear Curette	straight, blunt, size 3	6-1/2" (16.5 cm)
MH19-290	BUCK Ear Curette	angled, blunt, size 00	6-1/2" (16.5 cm)
MH19-292	BUCK Ear Curette	angled, blunt, size 0	6-1/2" (16.5 cm)
MH19-294	BUCK Ear Curette	angled, blunt, size 1	6-1/2" (16.5 cm)
MH19-296	BUCK Ear Curette	angled, blunt, size 2	6-1/2" (16.5 cm)
MH19-298	BUCK Ear Curette	angled, blunt, size 3	6-1/2" (16.5 cm)
MH19-314	BILLEAU Flexible Ear Loop	small size no. 1	6-1/2" (16.5 cm)
MH19-316	BILLEAU Flexible Ear Loop	medium size no. 2	6-1/2" (16.5 cm)
MH19-318	BILLEAU Flexible Ear Loop	large size no. 3	6-1/2" (16.5 cm)



MH19-280 to
MH19-288



MH19-290 to
MH19-298



MH19-314



MH19-316



MH19-318

Curettes

REF	Description	Type	Length
MH19-700	SPRATT Curette	size 5/0	6-1/2" (16.5 cm)
MH19-702	SPRATT Curette	size 4/0	6-1/2" (16.5 cm)
MH19-704	SPRATT Curette	size 3/0	6-1/2" (16.5 cm)
MH19-706	SPRATT Curette	size 2/0	6-1/2" (16.5 cm)
MH19-708	SPRATT Curette	size 0	6-1/2" (16.5 cm)
MH19-710	SPRATT Curette	size 1	6-1/2" (16.5 cm)
MH19-712	SPRATT Curette	size 2	6-1/2" (16.5 cm)
MH19-714	SPRATT Curette	size 3	6-1/2" (16.5 cm)
MH19-716	SPRATT Curette	size 4	6-1/2" (16.5 cm)
MH19-718	SPRATT Curette	size 5	6-1/2" (16.5 cm)
MH19-720	SPRATT Curette	size 6	6-1/2" (16.5 cm)
MH26-1627	HIBBS SPRATT Curette	oval cup, size 3/0	9" (22.9 cm)
MH26-1628	HIBBS SPRATT Curette	oval cup, size 2/0	9" (22.9 cm)
MH26-1629	HIBBS SPRATT Curette	oval cup, size 0	9" (22.9 cm)
MH26-1630	HIBBS SPRATT Curette	oval cup, size 1	9" (22.9 cm)
MH26-1632	HIBBS SPRATT Curette	oval cup, size 2	9" (22.9 cm)
MH26-1634	HIBBS SPRATT Curette	oval cup, size 3	9" (22.9 cm)
MH26-1636	HIBBS SPRATT Curette	oval cup, size 4	9" (22.9 cm)
MH26-1638	HIBBS SPRATT Curette	oval cup, size 5	9" (22.9 cm)
MH26-1640	HIBBS SPRATT Curette	oval cup, size 6	9" (22.9 cm)

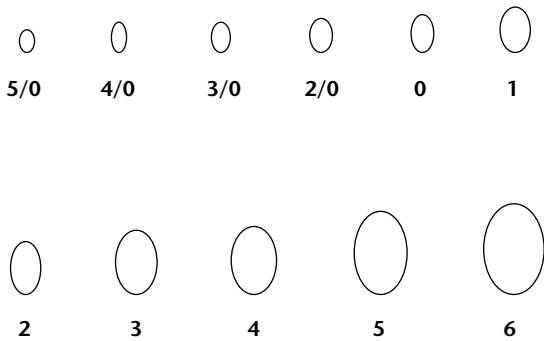

MH19-700 to
MH19-720

MH26-1627 to
MH26-1640

Rongeurs

REF	Description	Type	Length
MH19-844	BEYER Rongeur	double action, slightly curved jaws 3.5 mm wide	7" (17.8 cm)
MH19-848	RUSKIN Rongeur	double action, straight 3 mm bite jaws	6" (15.2 cm)
MH19-849	RUSKIN Rongeur	double action, curved 3 mm bite jaws	6" (15.2 cm)
MH19-850	RUSKIN Rongeur	double action, straight 5 mm bite jaws	7-1/4" (18.4 cm)
MH19-852	RUSKIN Rongeur	double action, curved 5 mm bite jaws	7-1/4" (18.4 cm)
MH19-1230	LEMPERT Rongeur	straight, delicate, 2.5 mm bite	6-1/4" (15.9 cm)
MH19-1232	LEMPERT Rongeur	curved, delicate, 2.5 mm bite	6-1/4" (15.9 cm)
MH25-454	STILLE-LUER Rongeur	straight jaws 9 mm x 15 mm	8-3/4" (22.2 cm)
MH25-456	STILLE-LUER Rongeur	curved jaws 9 mm x 15 mm	8-3/4" (22.2 cm)
MH25-458	STILLE-LUER Duckbill Rongeur	angled on side jaws 6 mm x 12mm	9" (22.9 cm)
MH25-480	SAUERBRUCH Rongeur	straight, square jaws 17 mm wide	12" (30.5 cm)
MH25-510	LEKSELL Rongeur	standard curve, 3 mm bite	9-1/2" (24.1 cm)
MH25-511	LEKSELL Rongeur	standard curve, 8 mm bite	9-1/2" (24.1 cm)



MH19-844

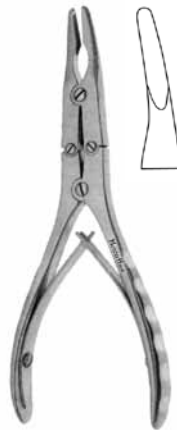

MH19-848
MH19-849



MH19-850
MH19-852

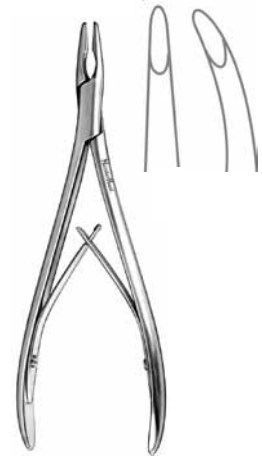

MH19-1230 to
MH19-1232



MH25-454
MH25-456



MH25-458



MH25-480



MH25-510
MH25-511

Mallets

REF	Description	Type	Length
MH19-793	Mallet	lightweight 7.5 oz. (213 g), stainless head 1" (2.5 cm) diameter with 2 replaceable nylon caps	7-1/2" (19.1 cm)
MH19-796	MEAD Mallet	head 8 oz. (227 g), with 2 replaceable nylon caps	7-1/2" (19.1 cm)



MH19-793



MH19-796

Osteotomes

REF	Description	Type	Length
MH21-205-2	SHEEHAN Osteotome	2 mm wide	6-1/4" (15.9 cm)
MH21-205-4	SHEEHAN Osteotome	4 mm wide	6-1/4" (15.9 cm)
MH21-205-6	SHEEHAN Osteotome	6 mm wide	6-1/4" (15.9 cm)
MH21-205-8	SHEEHAN Osteotome	8 mm wide	6-1/4" (15.9 cm)
MH21-205-10	SHEEHAN Osteotome	10 mm wide	6-1/4" (15.9 cm)
MH21-205-12	SHEEHAN Osteotome	12 mm wide	6-1/4" (15.9 cm)
MH21-206-4	COTTLE Osteotome	4 mm wide, rounded corners	7" (17.8 cm)
MH21-206-7	COTTLE Osteotome	7 mm wide, rounded corners	7" (17.8 cm)
MH21-206-9	COTTLE Osteotome	9 mm wide, rounded corners	7" (17.8 cm)
MH21-206-12	COTTLE Osteotome	12 mm wide, rounded corners	7" (17.8 cm)
MH21-232	NEIVERT Osteotome	straight, with single guard	8" (20.3 cm)
MH21-233	NEIVERT-ANDERSON Osteotome	curved right, with single guard	8" (20.3 cm)
MH21-234	NEIVERT-ANDERSON Osteotome	curved left, with single guard	8" (20.3 cm)
MH27-438	HIBBS Osteotome	straight, 1/4" (.64 cm)	9" (22.9 cm)
MH27-438C	HIBBS Osteotome	curved, 1/4" (.64 cm)	9" (22.9 cm)
MH27-440	HIBBS Osteotome	straight, 3/8" (.95 cm)	9" (22.9 cm)
MH27-440C	HIBBS Osteotome	curved, 3/8" (.95 cm)	9" (22.9 cm)
MH27-442	HIBBS Osteotome	straight, 1/2" (1.3 cm)	9" (22.9 cm)
MH27-442C	HIBBS Osteotome	curved, 1/2" (1.3 cm)	9" (22.9 cm)



MH21-205-2 to
MH21-205-12



MH21-206-4 to
MH21-206-12



MH21-232



MH21-233



MH21-234



MH27-438 to
MH27-442C

Osteotomes

REF	Description	Type	Length
MH27-444	HIBBS Osteotome	straight, 5/8" (1.6 cm)	9" (22.9 cm)
MH27-444C	HIBBS Osteotome	curved, 5/8" (1.6 cm)	9" (22.9 cm)
MH27-446	HIBBS Osteotome	straight, 3/4" (1.9 cm)	9" (22.9 cm)
MH27-446C	HIBBS Osteotome	curved, 3/4" (1.9 cm)	9" (22.9 cm)
MH27-447	HIBBS Osteotome	straight, 7/8" (2.2 cm)	9" (22.9 cm)
MH27-447C	HIBBS Osteotome	curved, 7/8" (2.2 cm)	9" (22.9 cm)
MH27-448	HIBBS Osteotome	straight, 1" (2.5 cm)	9" (22.9 cm)
MH27-448C	HIBBS Osteotome	curved, 1" (2.5 cm)	9" (22.9 cm)
MH27-488	LAMBOTTE Osteotome	straight, 1/4" (6 mm)	9" (22.9 cm)
MH27-490	LAMBOTTE Osteotome	straight, 1/2" (13 mm)	9" (22.9 cm)
MH27-492	LAMBOTTE Osteotome	straight, 3/4" (19 mm)	9" (22.9 cm)
MH27-494	LAMBOTTE Osteotome	straight, 1" (25 mm)	9" (22.9 cm)
MH27-496	LAMBOTTE Osteotome	straight, 1-1/4" (32 mm)	9" (22.9 cm)
MH27-498	LAMBOTTE Osteotome	straight, 1-1/2" (38 mm)	9" (22.9 cm)
MH27-499	LAMBOTTE Osteotome	curved, 1/4" (6 mm)	9" (22.9 cm)
MH27-500	LAMBOTTE Osteotome	curved, 1/2" (13 mm)	9" (22.9 cm)
MH27-502	LAMBOTTE Osteotome	curved, 3/4" (19 mm)	9" (22.9 cm)
MH27-504	LAMBOTTE Osteotome	curved, 1" (25 mm)	9" (22.9 cm)
MH27-506	LAMBOTTE Osteotome	curved, 1-1/4" (32 mm)	9" (22.9 cm)
MH27-508	LAMBOTTE Osteotome	curved, 1-1/2" (38 mm)	9" (22.9 cm)



MH27-444 to
MH27-448



MH27-444C to
MH27-448C



MH27-488 to
MH27-498



MH27-499 to
MH27-508

Elevators

REF	Description	Type	Length
MH18-1968	FREER Elevator	double end, sharp & blunt blades 5 mm wide	7" (17.8 cm)
MH21-60	COTTLE Septum Elevator	double end, graduated in cm	9" (22.9 cm)
MH21-64	JOSEPH Periosteal Elevator	strong curved blade 6.5 mm wide	7" (17.8 cm)
MH21-72	COTTLE Skin Elevator	slightly curved blade 9 mm wide	7-1/2" (19.1 cm)
MH26-1410	LANGENBECK Periosteal Elevator	narrow model, 7 mm wide blunt blade	7-1/2" (19.1 cm)
MH26-1412	LANGENBECK Periosteal Elevator	wide model, 17 mm wide sharp blade	7-1/2" (19.1 cm)
MH27-820	KEY Periosteal Elevator	1/4" (.64 cm) wide	7" (17.8 cm)
MH27-822	KEY Periosteal Elevator	1/2" (1.3 cm) wide	7-1/2" (19.1 cm)
MH27-824	KEY Periosteal Elevator	3/4" (1.9 cm) wide	8" (20.3 cm)
MH27-826	KEY Periosteal Elevator	1" (2.5 cm) wide	8-1/4" (21 cm)



MH18-1968

MH21-60

MH21-64

MH21-72

MH26-1410

MH26-1412

MH27-820 to
MH27-826

Biopsy Forceps

REF	Description	Type	Length
MH30-1405	THOMS-GAYLOR Uterine Biopsy Forceps	angled shank, curved jaws, 5 mm bite, interfitted cups	8-1/2" (21.6 cm)
MH30-1442	TISCHLER Cervical Biopsy Punch Forceps	7 mm x 3 mm x 1.5 mm bite	8" (20.3 cm) shaft
MH30-1443	BURKE (Modified Baby TISCHLER) Cervical Biopsy Punch Forceps	4.5 mm x 3 mm x 1.5 mm bite	7-3/4" (19.7 cm) shaft
MH30-1482	KEVORKIAN-YOUNGE Uterine Biopsy Forceps	3.5 mm x 8 mm bite, teeth on lower jaw	9-1/2" (24.1 cm) shaft
MH30-1485	EPPENDORFER Uterine Biopsy Forceps	-	8-1/2" (21.6 cm) shaft



MH30-1405

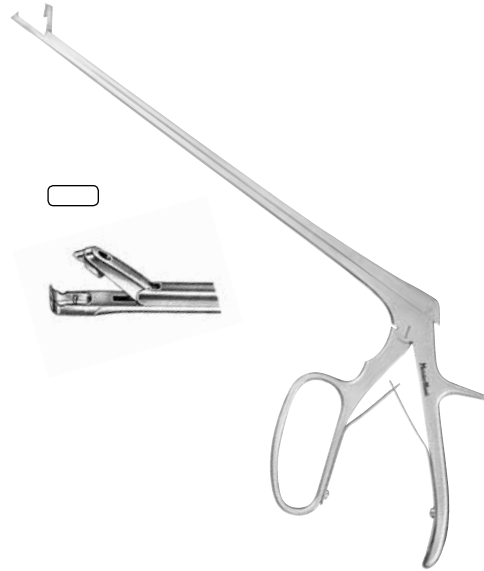

MH30-1442

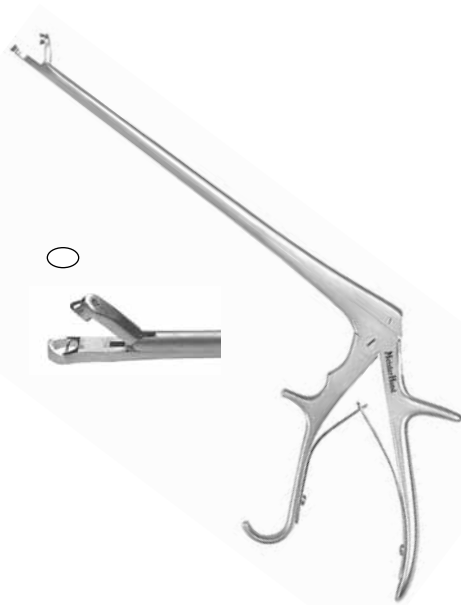

MH30-1443

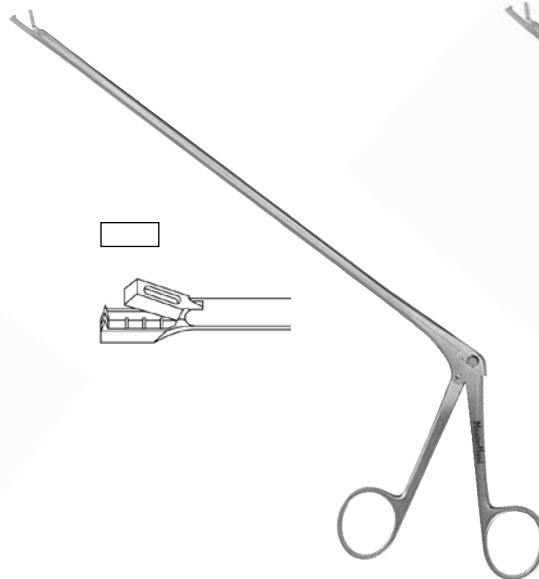

MH30-1482

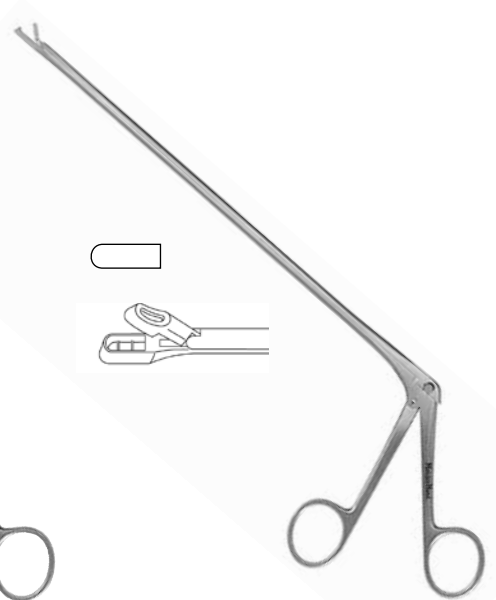

MH30-1485

Scalpel Handles

REF	Description	Type
MH4-7*	Knife Handle	no. 3, fitting surgical blades nos. 10 through 15c, extra fine
MH4-8*	Knife Handle	no. 4, fitting surgical blades nos. 20 through 25, extra fine
MH4-9	Knife Handle	no. 7, fitting surgical blades nos. 10 through 15c, extra fine
MH4-10	Knife Handle	no. 3L, for deep surgery, fitting surgical blades nos. 10 thru 15c, extra fine

* Handles have mm & cm graduations



MH4-7



MH4-8



MH4-9



MH4-10

Saws

REF	Description	Type	Size
MH26-119	GIGLI Saw Handle	standard pattern, T-shaped, turnable	-
MH26-124	GIGLI-STRULLY Saw Handle	standard pattern, loop grip, rigid, with snap lock	-
MH33-140	Finger Ring Cutter	with circular saw blade, chrome	6-1/2" (16.5 cm)
MH33-142	Replacement Blade	fits Finger Ring Cutter MH33-140, chrome	-

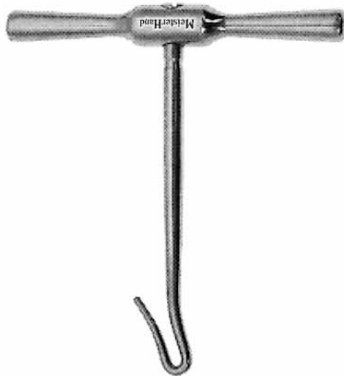

MH26-119

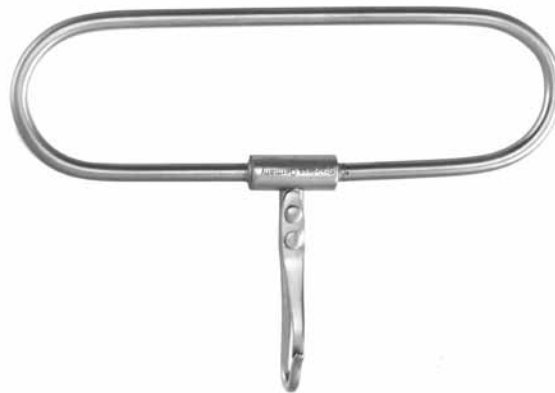

MH26-124

MH33-140
MH33-142

MILTEX® VANTAGE® INSTRUMENTS

Scissors	490
Forceps	491-493
Needle Holders.....	493
Towel Clamps	493
Kits.....	494
Retractors, Currettes, Dermal	494
Dental Instruments.....	495-496

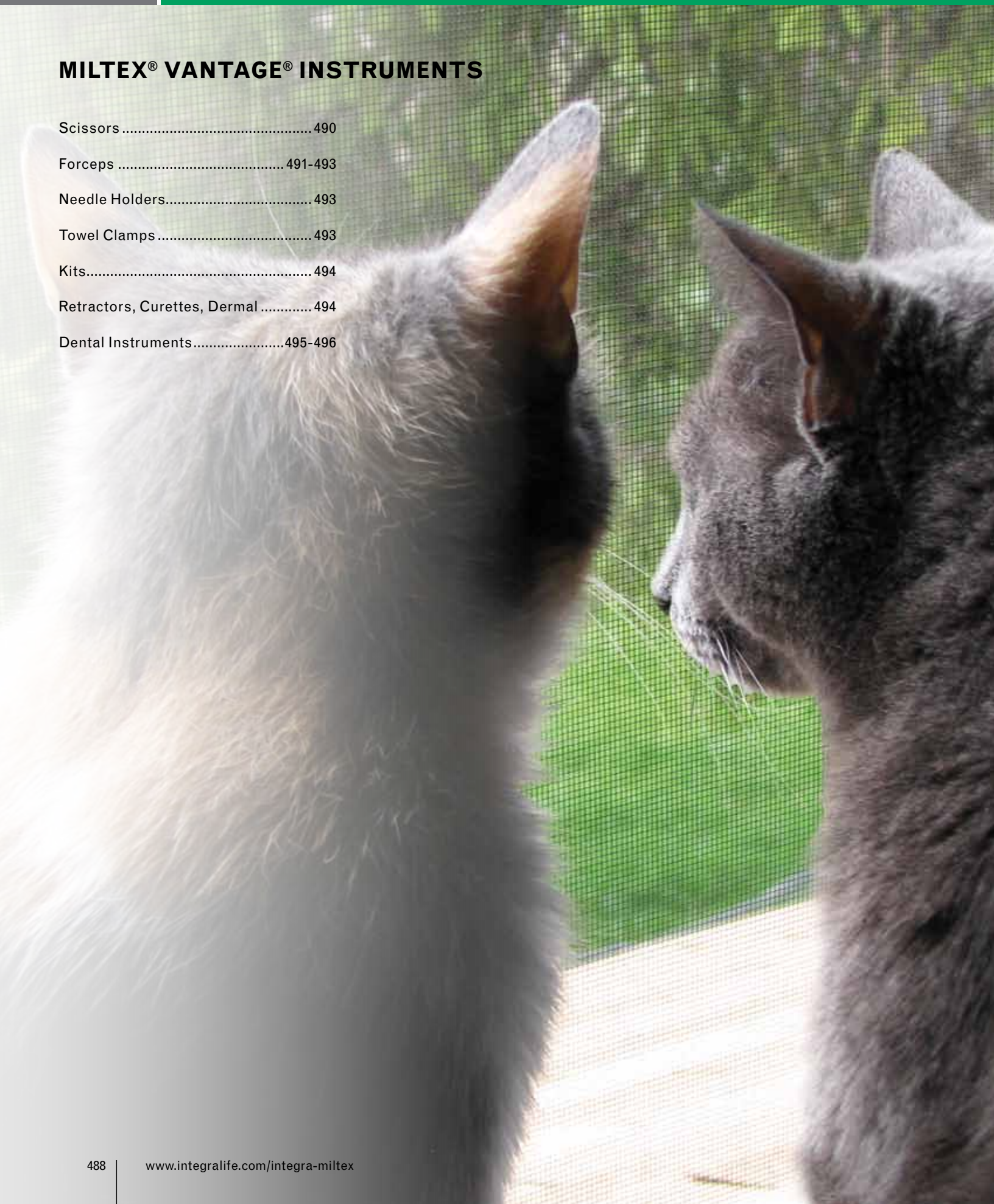



I N T R O D U C T I O N

Vantage® Instruments are forged from high quality Japanese stainless steel and then “finished” at low cost manufacturing facilities carefully selected by Miltex to ensure a quality instrument available to our customers at a cost competitive price.

This combination offers a high quality product at a “mid-grade” price and ensures a pattern consistency throughout the Vantage® product line.

The unique “Advantage” from Miltex is to provide positive choices to the Professional when confronted with important budgetary considerations.

Scissors

REF	Description	Type	Length
V1718	VANTAGE White Dog Nail Scissors	-	
V95-2	VANTAGE Operating Scissors	straight, sharp/sharp	4-1/2" (11.4 cm)
V95-4	VANTAGE Operating Scissors	straight, sharp/sharp	5" (12.7 cm)
V95-6	VANTAGE Operating Scissors	straight, sharp/sharp	5-1/2" (14 cm)
V95-8	VANTAGE Operating Scissors	straight, sharp/sharp	6-1/2" (16.5 cm)
V95-9	VANTAGE Operating Scissors	straight, sharp/sharp	7-1/2" (19.1 cm)
V95-12	VANTAGE Operating Scissors	straight, sharp/blunt	4-1/2" (11.4 cm)
V95-16	VANTAGE Operating Scissors	straight, sharp/blunt	5-1/2" (14 cm)
V95-18	VANTAGE Operating Scissors	straight, sharp/blunt	6-1/2" (16.5 cm)
V95-19	VANTAGE Operating Scissors	straight, sharp/blunt	7-1/2" (19.1 cm)
V95-22	VANTAGE Operating Scissors	straight, blunt/blunt	4-1/2" (11.4 cm)
V95-26	VANTAGE Operating Scissors	straight, blunt/blunt	5-1/2" (14 cm)
V95-28	VANTAGE Operating Scissors	straight, blunt/blunt	6-1/2" (16.5 cm)
V95-29	VANTAGE Operating Scissors	straight, sharp/blunt	7-1/2" (19.1 cm)
V95-32	VANTAGE Operating Scissors	curved, sharp/sharp	4-1/2" (11.4 cm)
V95-36	VANTAGE Operating Scissors	curved sharp/sharp	5-1/2" (14 cm)
V95-38	VANTAGE Operating Scissors	curved, sharp/sharp	6-1/2" (16.5 cm)
V95-42	VANTAGE Operating Scissors	curved, sharp/blunt	4-1/2" (11.4 cm)
V95-46	VANTAGE Operating Scissors	curved, sharp/blunt	5-1/2" (14 cm)
V95-48	VANTAGE Operating Scissors	curved, sharp/blunt	6-1/2" (16.5 cm)
V95-52	VANTAGE Operating Scissors	curved, blunt/blunt	4-1/2" (11.4 cm)
V95-56	VANTAGE Operating Scissors	curved, blunt/blunt	5-1/2" (14 cm)
V95-58	VANTAGE Operating Scissors	curved, blunt/blunt	6-1/2" (16.5 cm)
V95-120	VANTAGE MAYO Dissecting Scissors	straight	5-1/2" (14 cm)
V95-122	VANTAGE MAYO Dissecting Scissors	curved	5-1/2" (14 cm)
V95-124	VANTAGE MAYO Dissecting Scissors	straight	6-3/4" (17.1 cm)
V95-126	VANTAGE MAYO Dissecting Scissors	curved	6-3/4" (17.1 cm)
V95-180	VANTAGE METZENBAUM Scissors	curved	5-1/2" (14 cm)
V95-182	VANTAGE METZENBAUM Scissors	curved	7" (17.8 cm)
V95-304	VANTAGE Iris Scissors	straight	4-1/8" (10.5 cm)
V95-306	VANTAGE Iris Scissors	curved	4-1/8" (10.5 cm)
V95-312	VANTAGE Strabismus Scissors	straight	4" (10.2 cm)
V95-314	VANTAGE Strabismus Scissors	curved	4" (10.2 cm)
V95-500SS	VANTAGE LISTER Bandage Scissors	-	3-1/2" (8.9 cm)
V95-502SS	VANTAGE LISTER Bandage Scissors	-	4-1/2" (11.4 cm)
V95-504SS	VANTAGE LISTER Bandage Scissors	-	5-1/2" (14 cm)
V95-506SS	VANTAGE LISTER Bandage Scissors	-	7-1/4" (18.4 cm)
V95-524	VANTAGE LISTER Bandage Scissors	gold plated	5-1/2" (14 cm)
V95-532	VANTAGE LISTER Bandage Scissors	with pocket clip	5-1/2" (14 cm)
V95-550	VANTAGE LISTER Bandage Scissors	one large finger ring	8" (20.3 cm)
V95-560	VANTAGE KNOWLES Bandage Scissors	-	5-1/2" (14 cm)
V95-568	VANTAGE ESMARCH Plaster Shears	-	8" (20.3 cm)
V95-600	VANTAGE First Aid Shears	with wire cutter, one serrated blade	8-1/2" (21.5 cm)
V95-1000	VANTAGE Universal Scissors	black handle	7-1/2" (19.1 cm)
V95-1025	VANTAGE Universal Scissors	red handle	7-1/2" (19.1 cm)
V95-1026	VANTAGE Universal Scissors	orange handle	7-1/2" (19.1 cm)
V95-1027	VANTAGE Universal Scissors	blue handle	7-1/2" (19.1 cm)
V95-1028	VANTAGE Universal Scissors	purple handle	7-1/2" (19.1 cm)
V95-1029	VANTAGE Universal Scissors	green handle	7-1/2" (19.1 cm)
V95-1030	VANTAGE Universal Scissors	yellow handle	7-1/2" (19.1 cm)
V99-100	VANTAGE SPENCER Stitch Scissors	delicate	3-1/2" (9.5 cm)
V99-102	VANTAGE LITTAUER JUNIOR Stitch Scissors	standard pattern	4-1/2" (11.4 cm)
V99-104	VANTAGE LITTAUER Stitch Scissors	standard pattern	5-1/2" (14 cm)
V99-124	VANTAGE Universal Wire Cutting Scissors	angular, one serrated blade	4-3/4" (12.1 cm)
V99D-133	VANTAGE Collar Crown Scissors	straight	4" (10.2 cm)
V99D-135	VANTAGE Collar Crown Scissors	curved	4" (10.2 cm)
V918-1462	VANTAGE STEVENS Tenotomy Scissors	straight/blunt	4-1/8" (10.5 cm)
V918-1466	VANTAGE STEVENS Tenotomy Scissors	curved/blunt	4-1/8" (10.5 cm)
V918-1652	VANTAGE Eye Suture Scissors	curved	3-3/4" (9.5 cm)

Forceps

REF	Description	Type	Length
V92-70	VANTAGE MAGILL Catheter Forceps	large	9" (22.8 cm)
V92-72	VANTAGE MAGILL Catheter Forceps	petite	7" (17.7 cm)
V93-10	VANTAGE Sterilizer Forceps	3-prong	8" (20.3 cm)
V96-1	VANTAGE Dressing Forceps	serrated tips	3-1/2" (8.9 cm)
V96-4	VANTAGE Dressing Forceps	serrated tips	4-1/2" (11.4 cm)
V96-6	VANTAGE Dressing Forceps	serrated tips	5" (12.7 cm)
V96-8	VANTAGE Dressing Forceps	serrated tips	5-1/2" (14 cm)
V96-10	VANTAGE Dressing Forceps,	serrated tips	6" (15.2cm)
V96-14	VANTAGE Dressing Forceps	serrated tips	8" (20.3 cm)
V96-16	VANTAGE Dressing Forceps	serrated tips	10" (25.4 cm)
V96-18	VANTAGE Dressing Forceps	serrated tips	12" (30.5 cm)
V96-40	VANTAGE Tissue Forceps	1 x 2 teeth	4-1/2" (11.4 cm)
V96-42	VANTAGE Tissue Forceps	1 x 2 teeth	5" (12.7 cm)
V96-44	VANTAGE Tissue Forceps	1 x 2 teeth	5-1/2" (14 cm)
V96-46	VANTAGE Tissue Forceps	1 x 2 teeth	6" (15.2 cm)
V96-104	VANTAGE SEMKEN Dressing Forceps	serrated	5" (12.7 cm)
V96-106	VANTAGE SEMKEN Tissue Forceps	1 x 2 teeth	5" (12.7 cm)
V96-118	VANTAGE ADSON Dressing Forceps	serrated tips	4-3/4" (12.1 cm)
V96-120	VANTAGE ADSON Tissue Forceps	1 x 2 teeth	4-3/4" (12.1 cm)
V96-124	VANTAGE BROWN-ADSON Tissue Forceps	7 x 7 teeth	4-3/4" (12.1 cm)
V96-142	VANTAGE RUSSIAN Tissue Forceps	-	6" (15.2 cm)
V96-197	VANTAGE JANSEN Bayonet Dressing Forceps	-	6-1/4" (15.9 cm)
V96-300	VANTAGE Splinter Forceps	fine serrated points	3-1/2" (8.9 cm)
V96-304	VANTAGE Splinter Forceps	fine serrated points	4-1/2" (11.4 cm)
V96-312	VANTAGE WALTER Splinter Forceps	straight	4-1/2" (11.4 cm)
V96-314	VANTAGE WALTER Splinter Forceps	curved	4-1/2" (11.4 cm)
V96-316	VANTAGE FEILCHENFELD Splinter Forceps	-	3" (7.6 cm)
V96-318	VANTAGE FEILCHENFELD Splinter Forceps	-	4-1/2" (11.4 cm)
V96-329	VANTAGE Splinter Forceps	magnifier, in black plastic case	3" (7.6 cm)
V96-336	VANTAGE VIRTUS Splinter Forceps	-	6" (15.2 cm)
V96-400	VANTAGE Splinter Liberators	reversible handle with needle sharp tips	5" (12.7 cm)
V96-410	VANTAGE Professional Splinter Removal Kit	V96-312 & V96-400 in case	-

Hemostatic Forceps

REF	Description	Type	Length
V97-2	VANTAGE HALSTED Mosquito Forceps	straight	5" (12.7 cm)
V97-4	VANTAGE HALSTED Mosquito Forceps	curved	5" (12.7 cm)
V97-24	VANTAGE HARTMAN Mosquito Forceps	straight	3-1/2" (8.9 cm)
V97-26	VANTAGE HARTMAN Mosquito Forceps	curved	3-1/2" (8.9 cm)
V97-30	VANTAGE PROVIDENCE HOSPITAL Forceps	straight	5-1/2" (14 cm)
V97-32	VANTAGE PROVIDENCE HOSPITAL Forceps	curved	5-1/2" (14 cm)
V97-36	VANTAGE KELLY Forceps	straight	5-1/2" (14 cm)
V97-38	VANTAGE KELLY Forceps	curved	5-1/2" (14 cm)
V97-42	VANTAGE CRILE Forceps	straight	5-1/2" (14 cm)
V97-44	VANTAGE CRILE Forceps	curved	5-1/2" (14 cm)
V97-46	VANTAGE CRILE Forceps	straight	6-1/4" (15.9 cm)
V97-48	VANTAGE CRILE Forceps	curved	6-1/4" (15.9 cm)
V97-66	VANTAGE KOCHER Forceps	straight, 1 x 2 teeth	5-1/2" (14 cm)
V97-68	VANTAGE KOCHER Forceps	curved, 1 x 2 teeth	5-1/2" (14 cm)
V97-92	VANTAGE RANKIN Forceps	straight	6-1/4" (15.9 cm)
V97-94	VANTAGE RANKIN Forceps	curved	6-1/4" (15.9 cm)
V97-118	VANTAGE ROCHESTER-PEAN Forceps	straight	5-1/2" (14 cm)
V97-120	VANTAGE ROCHESTER-PEAN Forceps	straight	6-1/4" (15.9 cm)
V97-122	VANTAGE ROCHESTER-PEAN Forceps	straight	7-1/4" (19.1 cm)
V97-124	VANTAGE ROCHESTER-PEAN Forceps	straight	8" (20.3 cm)
V97-126	VANTAGE ROCHESTER-PEAN Forceps	straight	9" (22.9 cm)
V97-128	VANTAGE ROCHESTER-PEAN Forceps	straight	10-1/4" (26 cm)
V97-136	VANTAGE ROCHESTER-PEAN Forceps	curved	5-1/2" (14 cm)

Hemostatic Forceps, continued

REF	Description	Type	Length
V97-138	VANTAGE ROCHESTER-PEAN Forceps	curved	6-1/4" (15.9 cm)
V97-140	VANTAGE ROCHESTER-PEAN Forceps	curved	7-1/4" (19.1 cm)
V97-142	VANTAGE ROCHESTER-PEAN Forceps	curved	8" (20.3 cm)
V97-144	VANTAGE ROCHESTER-PEAN Forceps	curved	9" (22.9 cm)
V97-146	VANTAGE ROCHESTER-PEAN Forceps	curved	10-1/4" (26 cm)
V97-150	VANTAGE ROCHESTER-OCHSNER Forceps	straight, 1 x 2 teeth	6-1/4" (15.9 cm)
V97-152	VANTAGE ROCHESTER-OCHSNER Forceps	straight, 1 x 2 teeth	7-1/4" (19.1 cm)
V97-154	VANTAGE ROCHESTER-OCHSNER Forceps	straight, 1 x 2 teeth	8" (20.3 cm)
V97-156	VANTAGE ROCHESTER-OCHSNER Forceps	straight, 1 x 2 teeth	9" (22.9 cm)
V97-157	VANTAGE ROCHESTER-OCHSNER Forceps	straight, 1 x 2 teeth	10" (25.4 cm)
V97-160	VANTAGE ROCHESTER-OCHSNER Forceps	curved, 1 x 2 teeth	6-1/4" (15.9 cm)
V97-162	VANTAGE ROCHESTER-OCHSNER Forceps	curved, 1 x 2 teeth	7-1/4" (19.1 cm)
V97-164	VANTAGE ROCHESTER-OCHSNER Forceps	curved, 1 x 2 teeth	8" (20.3 cm)
V97-166	VANTAGE ROCHESTER-OCHSNER Forceps	curved, 1 x 2 teeth	9" (22.9 cm)
V97-167	VANTAGE ROCHESTER-OCHSNER Forceps	curved, 1 x 2 teeth	10" (25.4 cm)
V97-170	VANTAGE ROCHESTER-CARMALT Forceps	straight	6-1/4" (15.9 cm)
V97-172	VANTAGE ROCHESTER-CARMALT Forceps	curved	6-1/4" (15.9 cm)
V97-180	VANTAGE ROCHESTER-CARMALT Forceps	straight	8" (20.3 cm)
V97-182	VANTAGE ROCHESTER-CARMALT Forceps	curved	8" (20.3 cm)
V97-584	VANTAGE ST. VINCENT Tube Occluding Forceps	curved, smooth jaws	6-1/2" (16.5 cm)
V97-585	VANTAGE Tube Occluding Forceps, U.S. Pattern	straight, serrated jaws with stop	5-3/4" (14.6 cm)
V97-588	VANTAGE Presbyterian Hospital Tube Occluding Forceps, English Pattern	straight, smooth jaws	4-1/2" (11.4 cm)
V97-590	VANTAGE Presbyterian Hospital Tube Occluding Forceps	straight, smooth jaws, heavy pattern	7" (17.8 cm)
V97-591	VANTAGE Presbyterian Hospital Tube Occluding Forceps, U.S. Pattern	straight serrated jaws with stop	7-1/2" (19.1 cm)
V97-600	VANTAGE FOERSTER Sponge Forceps	straight, serrated jaws	9-1/2" (24.1 cm)
V97-604	VANTAGE FOERSTER Sponge Forceps	straight, serrated jaws	7" (17.8 cm)
V97-610	VANTAGE FOERSTER Sponge Forceps	curved, serrated jaws	9-1/2" (24.1 cm)
V97-622	VANTAGE BOZEMAN Dressing Forceps	double curved	10-1/2" (26.7 cm)
V99-60	VANTAGE MICHEL Clip Applying Removing Forceps	double-end	5" (12.7 cm)
V916-6	VANTAGE ALLIS Tissue Forceps	4 x 5 teeth	6" (15.2 cm)
V916-8	VANTAGE ALLIS Tissue Forceps	5 x 6 teeth	6" (15.2cm)
V916-10	VANTAGE ALLIS Tissue Forceps	5 x 6 teeth	7-1/4" (18.4 cm)
V916-44	VANTAGE BABCOCK Tissue Forceps	8 mm wide jaws	6-1/4" (15.9 cm)
V916-160	VANTAGE DOYEN Intestinal Forceps	straight, longitudinal serrations	9" (22.9 cm)
V916-162	VANTAGE DOYEN Intestinal Forceps	curved, longitudinal serrations	9" (22.9 cm)

Tissue Forceps

REF	Description	Type	Length
V918-780	VANTAGE Eye Dressing Forceps	straight, serrated	4" (10.2 cm)
V918-782	VANTAGE Eye Dressing Forceps	half curved, serrated	4" (10.2 cm)
V918-784	VANTAGE Eye Dressing Forceps	full curved, serrated	4" (10.2 cm)
V918-786	VANTAGE Iris Forceps	straight, 1 x 2 teeth	4" (10.2 cm)
V918-788	VANTAGE Iris Forceps	half curved, 1 x 2 teeth	4" (10.2 cm)
V918-790	VANTAGE Iris Forceps	full curved, 1 x 2 teeth	4" (10.2 cm)
V918-850	VANTAGE GRAEFE Tissue Forceps	fine teeth	4-3/8" (11.2 cm)
V918-866	VANTAGE BISHOP-HARMON Dressing Forceps	serrated	3-3/8" (8.6 cm)
V918-868	VANTAGE BISHOP-HARMON Tissue Forceps	1 x 2 teeth	3-3/8" (8.6 cm)
V918-1110	VANTAGE BERGH Cilia Forceps	fine serrated jaws	3-1/2" (8.9 cm)
V919-350	VANTAGE WILDE Ear Forceps	angular, serrated tips	5" (12.7 cm)
V919-370	VANTAGE LUCAE Ear Forceps	bayonet shape, serrated tips	5-1/2" (14 cm)



Towel Clamps

REF	Description	Type	Length
V97-500	VANTAGE JONES Towel Clamp	-	3-1/2" (8.9 cm)
V97-504	VANTAGE BACKHAUS Towel Clamp	-	3-1/2" (8.9 cm)
V97-506	VANTAGE BACKHAUS Towel Clamp	-	5-1/4" (14 cm)
V97-510	VANTAGE ROEDER Towel Clamp	with ball stops	5-1/4" (14 cm)
V97-514	VANTAGE LORNA Non-Perforating Towel Forceps	-	3-3/4" (9.5 cm)
V97-515	VANTAGE LORNA Non-Perforating Towel Forceps	-	5-1/4" (14 cm)
V97-520	VANTAGE PEERS Non-Perforating Towel Clamp	-	5-3/4" (14.6 cm)

Alligator Forceps

REF	Description	Type	Length
V919-434	VANTAGE HARTMAN NOYES Alligator Forceps	serrated jaws	3-1/4" (8.3 cm) shaft
V919-434A	VANTAGE HARTMAN NOYES Alligator Forceps	serrated jaws extra delicate pattern	3-1/4" (8.3 cm) shaft
V920-140	VANTAGE NOYES Alligator Forceps	serrated jaws	5-1/2" (14 cm)
V920-142	VANTAGE NOYES Alligator Forceps	shaft, serrated jaws	6-1/2" (16.5 cm)

Bone Cutting Forceps

REF	Description	Type	Length
V927-4	VANTAGE KERN Bone Forceps	with ratchet	9-1/2" (24.1 cm)
V927-7	VANTAGE KERN Bone Forceps	with ratchet	6-1/2" (16.5 cm)
V927-1390	VANTAGE LISTON Bone Cutting Forceps	straight	5-1/2" (14 cm)
V927-3100	VANTAGE Cast Spreader	3-prong, with spring	9" (22.9 cm)

Needle Holders

REF	Description	Type	Length
V98-2	VANTAGE COLLIER Needle Holder	fenestrated jaws	5" (12.7 cm)
V98-4	VANTAGE DERF Needle Holder	-	4-3/4" (12.1 cm)
V98-6	VANTAGE WEBSTER Needle Holder	smooth jaws	5" (12.7 cm)
V98-8	VANTAGE HALSEY Needle Holder	smooth jaws	5" (12.7 cm)
V98-15	VANTAGE OLSEN-HEGAR Needle Holder	with suture scissors	5-1/2" (14 cm)
V98-16	VANTAGE OLSEN-HEGAR Needle Holder	with suture scissors	6-1/2" (16.5 cm)
V98-17	VANTAGE OLSEN-HEGAR Needle Holder	with suture scissors	7-1/2" (19.1 cm)
V98-28	VANTAGE MATHIEU Needle Holder	spring handles	5-1/2" (14 cm)
V98-40	VANTAGE BAUMGARTNER Needle Holder	-	5-1/2" (14 cm)
V98-42	VANTAGE MAYO-HEGAR Needle Holder	-	5" (12.7 cm)
V98-44	VANTAGE MAYO-HEGAR Needle Holder	-	6" (15.2 cm)
V98-46	VANTAGE MAYO-HEGAR Needle Holder	-	7" (17.8 cm)
V98-48	VANTAGE MAYO-HEGAR Needle Holder	-	8" (20.3 cm)
V98-50	VANTAGE CRILE-WOOD Needle Holder	delicate jaws	6" (15.2 cm)
V918-1828	VANTAGE CASTROVIEJO Needle Holder	straight, with catch	5-1/2" (14 cm)

Retractors

REF	Description	Type	Length
V911-366	VANTAGE GELPI Retractor	grip lock ratchet	6-3/4" (17.1 cm)
V911-600	VANTAGE WEITLANER Retractor	sharp 2 x 3 teeth, grip lock ratchet	4" (10.2 cm)
V911-602	VANTAGE WEITLANER Retractor	blunt 2 x 3 teeth, grip lock ratchet	4" (10.2 cm)
V911-608	VANTAGE WEITLANER Retractor	sharp 3 x 4 teeth, grip lock ratchet	5-1/2" (14 cm)
V911-610	VANTAGE WEITLANER Retractor	blunt 3 x 4 teeth, grip lock ratchet	5-1/2" (14 cm)
V911-614	VANTAGE WEITLANER Retractor	sharp 3 x 4 teeth, grip lock ratchet	6-1/2" (16.5 cm)
V911-616	VANTAGE WEITLANER Retractor	blunt 3 x 4 teeth, grip lock ratchet	6 1/2" (16.5cm)
V911-74	VANTAGE SENN Retractor	double ended, 3 sharp prongs	6-3/8" (16.2 cm)
V96006	VANTAGE Covault Hook	octagon handle	-
V96008	VANTAGE Snook Hook	flat handle	8" (20.3 cm)
V918-412	VANTAGE TYRELL Hook	sharp	-

Ear Curettes & Syringes

REF	Description	Type	Length
V919-280	VANTAGE BUCK Ear Curette	straight/blunt	size 00
V919-282	VANTAGE BUCK Ear Curette	straight/blunt	size 0
V919-284	VANTAGE BUCK Ear Curette	straight/blunt	size 1
V919-286	VANTAGE BUCK Ear Curette	straight/blunt	size 2
V919-288	VANTAGE BUCK Ear Curette	straight/blunt	size 3
V919-381	VANTAGE Metal Ear Syringe	2-ounce capacity	-
V919-383	VANTAGE Metal Ear Syringe	3-ounce capacity	-
V919-385	VANTAGE Metal Ear Syringe	4-ounce capacity	-
V919-390	VANTAGE short bulbous tip	-	-
V919-394	VANTAGE tapered tip for Metal Ear Syringes	-	-
V919-396	VANTAGE shield for Metal Ear Syringes	-	-

Dermal Instruments & Hooks

REF	Description	Type	Length
V91-226	VANTAGE WARTENBERG Pinwheel	-	-
V933-140	VANTAGE Finger Ring Cutter	chrome plated, tool steel saw blade	6-1/4" (15.9 cm)
V933-142	VANTAGE Finger Ring Cutter Blades	tool steel saw blade	-
V933-200	VANTAGE Comedone Extractor	open ends	-
V933-201	VANTAGE SCHAMBERG Comedone Extractor	small end crimped	-
V966-317	VANTAGE College Pliers	with pin, serrated tips	6" (15.2 cm)
V966-652	VANTAGE Self-Locking College Pliers	serrated tips	6" (15.2 cm)

Instrument Kits

REF	Description	Type	Length
V96800	VANTAGE General Surgery Kit	-	-
V96810	VANTAGE Canine Spay Kit	-	-
V96820	VANTAGE Feline Spay Kit	-	-

Dental Carriers, Carvers, Pliers & Scrapers

REF	Description	Type
V971-50	VANTAGE Amalgam Carrier	single ended, medium stainless barrel
V971-51	VANTAGE Amalgam Carrier	single ended, medium barrel
V971-52	VANTAGE Amalgam Carrier	single ended, large stainless barrel
V971-53	VANTAGE Amalgam Carrier	single ended, large barrel
V971-54	VANTAGE Amalgam Carrier	single ended, jumbo stainless barrel
V971-55	VANTAGE Amalgam Carrier	single ended, jumbo barrel
V971-62	VANTAGE Amalgam Carrier	double ended, medium/large stainless barrel
V971-63	VANTAGE Amalgam Carrier	double ended, medium/large barrel
V971-64	VANTAGE Amalgam Carrier	double ended, medium/jumbo stainless barrel
V971-65	VANTAGE Amalgam Carrier	double ended, medium/jumbo barrel
V971-66	VANTAGE Amalgam Carrier	double ended, large/jumbo stainless barrel
V971-67	VANTAGE Amalgam Carrier	double ended, large/jumbo barrel
V971-68	VANTAGE Amalgam Carrier	double ended, jumbo/jumbo stainless barrel
V971-69	VANTAGE Amalgam Carrier	double ended, jumbo/jumbo barrel
V973-48	VANTAGE No. 5 LECRON Inlay Carver	-
V973-52	VANTAGE ROACH Wax Carver	-
V973-54	VANTAGE VEHE Wax Carver	-
V973-62	VANTAGE No. 7 Wax Spatula	-
V973-70	VANTAGE No. 24 Cement Spatula	flexible blade
V973-72	VANTAGE No. 24A Cement Spatula	rigid blade
V974-20	VANTAGE No. 110 Pliers	-
V974-30	VANTAGE No. 114 Pliers	-
V974-40	VANTAGE No. 118 Pliers	-
V974-45	VANTAGE No. 121 Pliers	-
V974-50	VANTAGE No. 137 Pliers	-
V974-55	VANTAGE No. 139 Pliers	-
V974-75	VANTAGE No. 200 Pliers	-
V96050/1	VANTAGE Tartar Scraper	single ended
V96050/6	VANTAGE Tartar Scraper	double ended

Dental Extracting Forceps

REF	Description	Type	Length
V90-1STD	VANTAGE 1 STD Extracting Forceps	-	7-1/4" (18.4 cm)
V90-1STD-CG	VANTAGE CERAM-A-GRIP 1 STD Extracting Forceps	-	7-1/4" (18.4 cm)
V90-1STD-SG	VANTAGE 1 STD Extracting Forceps	serrated	7-1/4" (18.4 cm)
V90-10S	VANTAGE 10S Extracting Forceps	-	7-1/4" (18.4 cm)
V90-10S-CG	VANTAGE CERAM-A-GRIP 10S Extracting Forceps	-	7-1/4" (18.4 cm)
V90-10S-SG	VANTAGE 10S Extracting Forceps	serrated	7-1/4" (18.4 cm)
V90-16	VANTAGE 16 Extracting Forceps	-	7-1/4" (18.4 cm)
V90-16-CG	VANTAGE CERAM-A-GRIP 16 Extracting Forceps	-	7-1/4" (18.4 cm)
V90-16-SG	VANTAGE 16 Extracting Forceps	serrated	7-1/4" (18.4 cm)
V90-17	VANTAGE 17 Extracting Forceps	-	7-1/4" (18.4 cm)
V90-17-CG	VANTAGE CERAM-A-GRIP 17 Extracting Forceps	-	7-1/4" (18.4 cm)
V90-17-SG	VANTAGE 17 Extracting Forceps	serrated	7-1/4" (18.4 cm)
V90-23	VANTAGE 23 Extracting Forceps	-	7-1/4" (18.4 cm)
V90-23-CG	VANTAGE CERAM-A-GRIP 23 Extracting Forceps	-	7-1/4" (18.4 cm)
V90-23-SG	VANTAGE 23 Extracting Forceps	serrated	7-1/4" (18.4 cm)
V90-53L	VANTAGE 53L Extracting Forceps	-	7-1/4" (18.4 cm)
V90-53L-CG	VANTAGE CERAM-A-GRIP 53L Extracting Forceps	-	7-1/4" (18.4 cm)
V90-53L-SG	VANTAGE 53L Extracting Forceps	serrated	7-1/4" (18.4 cm)
V90-53R	VANTAGE 53R Extracting Forceps	-	7-1/4" (18.4 cm)
V90-53R-CG	VANTAGE CERAM-A-GRIP 53R Extracting Forceps	-	7-1/4" (18.4 cm)
V90-53R-SG	VANTAGE 53R Extracting Forceps	serrated	7-1/4" (18.4 cm)

Dental Extracting Forceps, continued

REF	Description	Type	Length
V90-62	VANTAGE 62 Extracting Forceps	-	7-1/4" (18.4 cm)
V90-62-CG	VANTAGE 62 Extracting Forceps	serrated	7-1/4" (18.4 cm)
V90-62-SG	VANTAGE 62 Extracting Forceps	serrated	7-1/4" (18.4 cm)
V90-65	VANTAGE 65 Extracting Forceps	-	7-1/4" (18.4 cm)
V90-65-CG	VANTAGE CERAM-A-GRIP 65 Extracting Forceps	-	7-1/4" (18.4 cm)
V90-65-SG	VANTAGE 65 Extracting Forceps	serrated	7-1/4" (18.4 cm)
V90-69	VANTAGE 69 Extracting Forceps	-	7-1/4" (18.4 cm)
V90-69-CG	VANTAGE CERAM-A-GRIP 69 Extracting Forceps	-	7-1/4" (18.4 cm)
V90-69-SG	VANTAGE 69 Extracting Forceps	serrated	7-1/4" (18.4 cm)
V90-88L	VANTAGE 88L Extracting Forceps	-	7-1/4" (18.4 cm)
V90-88L-CG	VANTAGE CERAM-A-GRIP 88L Extracting Forceps	-	7-1/4" (18.4 cm)
V90-88L-SG	VANTAGE 88L Extracting Forceps	serrated	7-1/4" (18.4 cm)
V90-88R	VANTAGE 88R Extracting Forceps	-	7-1/4" (18.4 cm)
V90-88R-CG	VANTAGE CERAM-A-GRIP 88R Extracting Forceps	-	7-1/4" (18.4 cm)
V90-88R-SG	VANTAGE 88R Extracting Forceps	serrated	7-1/4" (18.4 cm)
V90-150	VANTAGE 150 Extracting Forceps	-	7-1/4" (18.4 cm)
V90-150-CG	VANTAGE CERAM-A-GRIP 150 Extracting Forceps	-	7-1/4" (18.4 cm)
V90-150-SG	VANTAGE 150 Extracting Forceps	serrated	7-1/4" (18.4 cm)
V90-150S	VANTAGE 150S Extracting Forceps	-	7-1/4" (18.4 cm)
V90-150S-CG	VANTAGE CERAM-A-GRIP 150S Extracting Forceps	-	7-1/4" (18.4 cm)
V90-150S-SG	VANTAGE 150S Extracting Forceps	serrated	7-1/4" (18.4 cm)
V90-151	VANTAGE 151 Extracting Forceps	-	7-1/4" (18.4 cm)
V90-151-CG	VANTAGE CERAM-A-GRIP 151 Extracting Forceps	-	7-1/4" (18.4 cm)
V90-151-SG	VANTAGE 151 Extracting Forceps	serrated	7-1/4" (18.4 cm)
V90-151S	VANTAGE 151S Extracting Forceps	-	7-1/4" (18.4 cm)
V90-151S-CG	VANTAGE CERAM-A-GRIP 151S Extracting Forceps	-	7-1/4" (18.4 cm)
V90-151S-SG	VANTAGE 151S Extracting Forceps	serrated	7-1/4" (18.4 cm)

CG - Ceram-A-Grip®

SG - Serrated

MILTEX® DISPOSABLE PRODUCTS

Biopsy Punches	498
Short Handle Biopsy Punch	498
BiopBlade™ and Curettes	499
Standard and Safety Scalpels	500
Surgical Blades & Scalpel Handles	501
Sparta™ Products	502



Biopsy Punch, Sterile

Now you can have the convenience of disposable punches along with the quality you expect from Miltex. Miltex offers an extensive product line of sterile disposable biopsy punches that are manufactured from the finest grade surgical steel to ensure superior cutting every time.

- Seamless, stainless steel, razor-sharp cutting edges eliminate torn or pulled biopsies
- Ribbed handle provides comfort and control
- Convenience of disposables, single-use
- Sterile, 5-year shelf life
- Sizes clearly marked on each punch
- Individual color-coded blister packs

Biopsy Punch with Plunger System

- Effortless ejection of lodged specimens
- Available in boxes of 25
- Color-coded by size; 5 sizes available



REF	Size
33-31AA-P/25	1.0 mm w/plunger
33-31A-P/25	1.5 mm w/plunger
33-31-P/25	2.0 mm w/plunger
33-32-P/25	3.0 mm w/plunger
33-34-P/25	4.0 mm w/plunger

Biopsy Punch, Standard

- Each dispenser box contains 50 punches
- 10 sizes for a wide range of applications
- Assortment box contains 10 each of the following: 2 mm, 3 mm, 4 mm, 5 mm and 6 mm

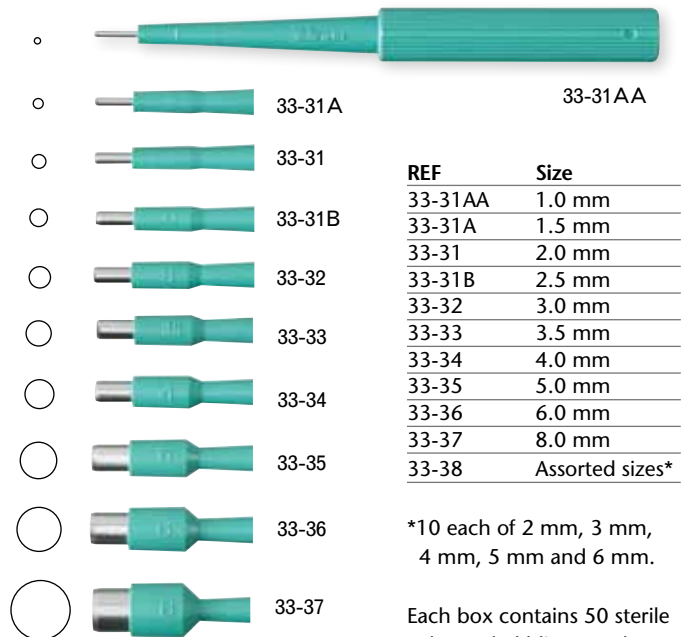

Each box contains 50 sterile color-coded blister packs.

Short Handled Biopsy Punch, Sterile

The Short Handled Biopsy Punch is designed to take tissue samples in all areas of the mouth. The Short Handled Biopsy Punch features the same razor-sharp blade as the original Miltex® biopsy punches, but the handle has been shortened to allow access in the hard to reach posterior areas of the mouth. The total length of the instrument is 1-1/16 inch!

This product is provided in sterile, individually wrapped packets for easy use and is available in the four most common sizes: 3.5 mm, 4 mm, 5 mm and 6 mm.

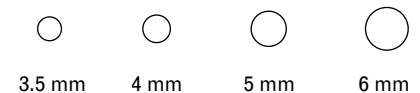

REF	Description	Size	Quantity
33-33-SH	Short Handled Biopsy Punch	3.5 mm	50/box
33-34-SH	Short Handled Biopsy Punch	4 mm	50/box
33-35-SH	Short Handled Biopsy Punch	5 mm	50/box
33-36-SH	Short Handled Biopsy Punch	6 mm	50/box

Items in **bold** represent the most popular patterns.

Miltex® BiopBlade™, Sterile

- Ideal for tissue saucerization and shave biopsy
- Incorporates a super sharp blade with rear Finger Guard
- Flexible design allows the blade to be positioned at any angle for the intended procedure
- Disposable, one-time use only
- Sterile, 5-year shelf life



REF	Description
33-100	Miltex BiopBlade 50 per box

Dermal Curettes, Sterile

- Seamless, stainless steel, semi-sharp cutting edge featuring a unique symmetrically ground beveled edge
- Textured handle provides better comfort and control
- Sterile, 3-year shelf life
- Individually packaged in peel-apart pouches
- Convenience of disposables, single-use
- Sizes clearly marked on each curette
- Each dispenser box contains 50 curettes
- 5 sizes available for a wide range of applications

REF	Size
33-52	2.0 mm
33-53	3.0 mm
33-54	4.0 mm
33-55	5.0 mm
33-57	7.0 mm

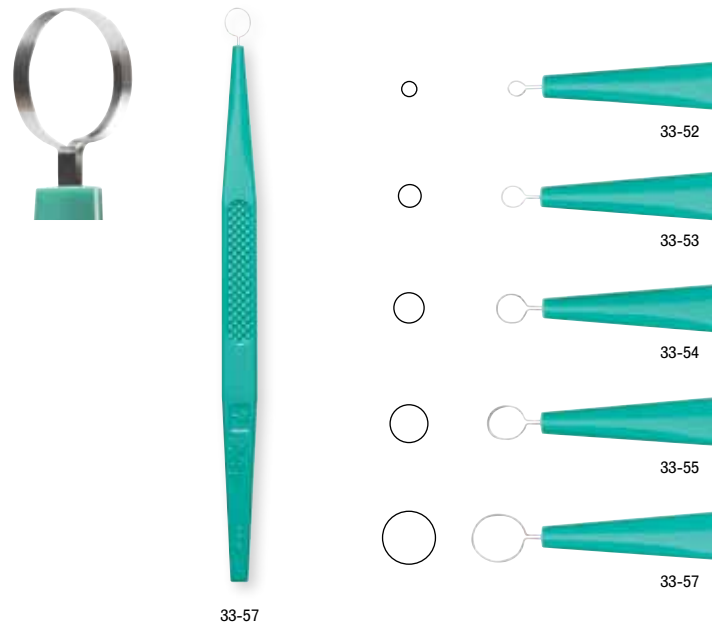

Ear Curettes, Disposable

- Each curette is individually wrapped, non-sterile
- Available in boxes of 50
- Color-coded and available in 4 tip configurations

REF	Description
19-320	Ring Tip, Pink
19-321	Loop Tip, White
19-322	Small Spoon Tip, Gray
19-323	Large Spoon Tip, Peach



Items in **bold** represent the most popular patterns.

Safety Scalpels, Sterile

- Complies with OSHA directive for the Needlestick Safety & Prevention Act
- Stainless steel, razor-sharp cutting edge for superior cutting and clean incisions
- Pre-assembled, fully retractable scalpel blade is user activated
- Individually packaged in sealed peel-apart pouches
- Metric ruler on each scalpel to assist in determining incision length
- Each dispenser box contains 10 safety scalpels

REF	Size
4-510	10
4-511	11
4-512	12
4-515	15
4-515C	15C Angled Blade
4-522	22

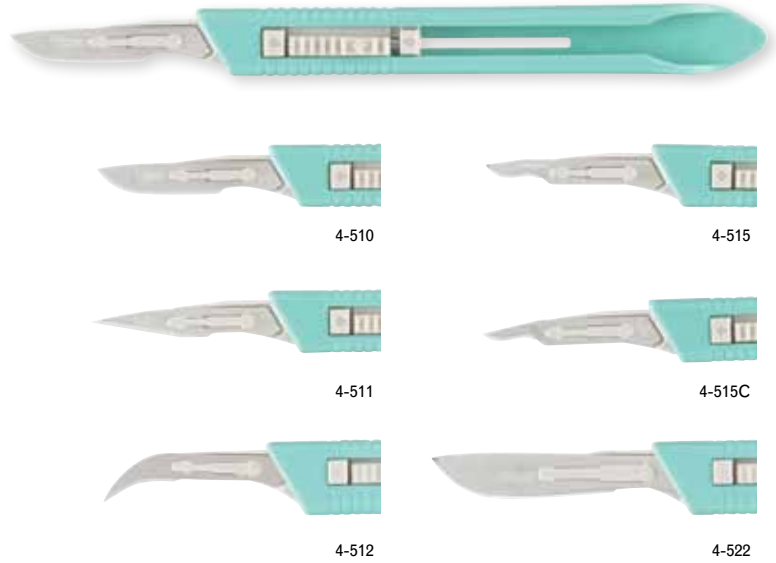

Directions For Use

Gently push slider to right and completely forward in one simple motion. Blade locks into place with audible confirmation. To retract blade, push slider to right and back to return blade to original protected position.

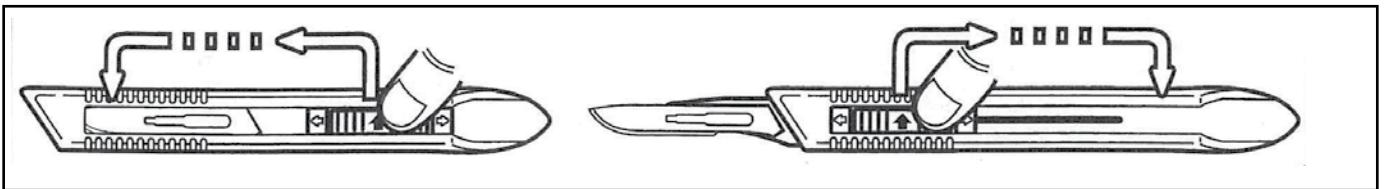

Scalpels, Standard, Sterile

- Stainless steel, razor-sharp cutting edge for superior cutting and clean incisions
- Safety sleeve for blade protects you and the blade
- Individually packaged in sealed peel-apart pouches
- Each dispenser box contains 10 scalpels

REF	Size
4-410	10
4-411	11
4-412	12
4-415	15
4-420	20
4-421	21
4-422	22
4-423	23

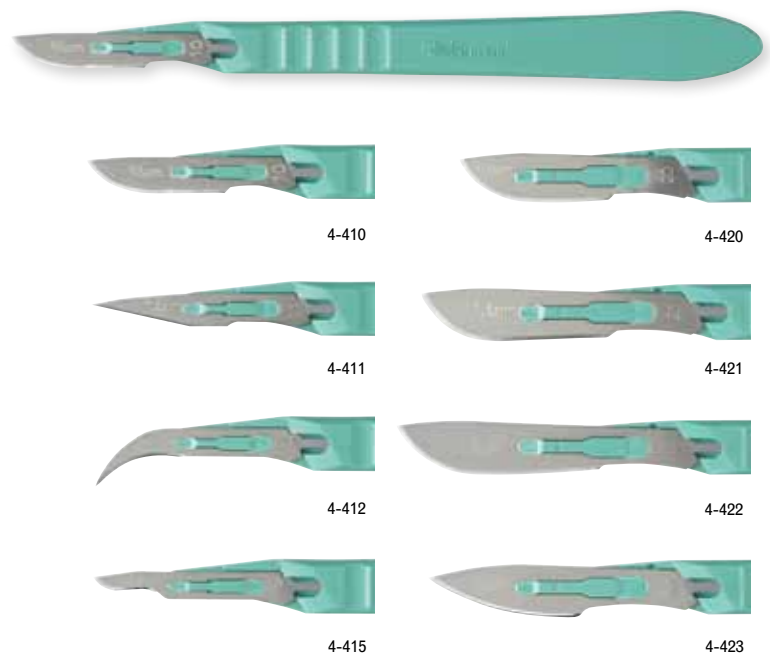

Items in **bold** represent the most popular patterns.

Surgical Blades, Sterile

Carbon, Stainless Steel or Silicone Coated

- Razor-sharp cutting edge for superior cutting and clean incisions
- Sterile, 5-year shelf life
- Individually packaged in foil peel packs
- Convenience of disposables, single-use
- Sizes clearly marked on each blade
- Available in carbon and stainless steel
- Each dispenser box contains 100 blades
- 11 sizes available

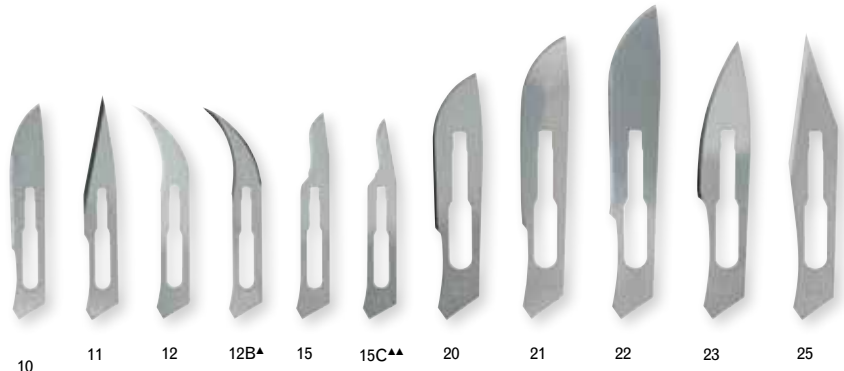

CS* REF	SS** REF	SC*** REF	Size	CS* REF	SS** REF	SC*** REF	Size
4-110	4-310	4610	10	4-120	4-320	-	20
4-111	4-311	4611	11	4-121	4-321	-	21
4-112	4-312	-	12	4-122	4-322	-	22
4-112B ^Δ	4-312B ^Δ	-	12B ^Δ	4-123	4-323	-	23
4-115	4-315	4615	15	4-125	4-325	-	25
4-115C ^{ΔΔ}	4-315C ^{ΔΔ}	-	15C ^{ΔΔ}				

*Carbon Steel **Stainless Steel ***Silicone Coated

^ΔB is a double edged blade ^{ΔΔ}C is an angled blade

Scalpel Handles

Miltex offers an array of scalpel blade handles. The Miltex® Blade Safe Remover affords protection against accidental cuts and punctures.

REF	Description	Fits Blades 10-15C	Fits Blades 20-25
4-7	No. 3, stainless steel 5" graduated in mm and cm	✓	
4-7R	No. 3, 5" graduated in mm and cm	✓	
4-8	No. 4, stainless steel 5.375" graduated in mm and cm		✓
4-8R	No. 4, Nickel 5.375" graduated in mm and cm		✓
4-9	No. 7, stainless steel 6.5"	✓	
4-10*	No. 3L, stainless steel 8.5"	✓	
4-11*	No. 4L, stainless steel 8.5"		✓
4-12*	No. 3LA, stainless steel, angled 8.5"	✓	
4-16	No. 9, stainless steel 4.5"	✓	
4-17	Siegel, stainless steel, round handle 5.75"	✓	
4-18	No. 5, plastic handle 5", green	✓	
4-20	No. 6, plastic handle 5.25", red		✓
4-30**	No. 3, fitting blades 5.5", grey	✓	
4-31**	No. 4, fitting blades 5.5", blue		✓
4-400***	Miniature Blade Handle w/chuck 3-3/4", round knurled (3K type)		✓
4-401***	Miniature Blade Handle w/self- locking chuck, 3-3/4", round knurled (3K type)		✓
4-405***	Self-locking chisel blade handle, stainless steel 5.31"		
4-100	Blade Safe surgical blade remover for any style handle		

* For deep surgery

** EZ-OFF reusable plastic knife handles, autoclavable, permitting quick and safe removal of blade, 10/box

*** Fits Mini Blade (blades not available from Miltex, Inc.)



Items in **bold** represent the most popular patterns.

Nasostat™ Treatment of Epistaxis

- Nasostat™ may be used in conjunction with anterior packing
- Will control bleeding while minimizing patient discomfort associated with nasal packs
- Is a safe and easily tolerated alternative to other treatments for Epistaxis. (e.g. cautery)
- Sterile, 1-year shelf life

REF	Description
41900	Nasostat Regular, Sterile 5/Bx
41901	Nasostat Slimline, Sterile 5/Bx
41902	Nasostat Large, Sterile 5/Bx
41903	Nasostat Small, Sterile 5/Bx



Surgi-Clamp, Plastic

- Non-sterile operatory clamp
- Multi-functional
- Safe for steam sterilization
- Designed for reuse
- No rust or stain problems

REF	Description
374201	Surgi-Clamp, Plastic 100/bx
374202	Surgi-Clamp, Plastic 25/bx



Surgi-Prep, Depilatory

- Fast-acting removal of body hair; dissolves unwanted hair below skin surface
- Lasts days longer than shaving
- Pain free formula; removes even coarse, stubborn hair
- No nicks, cuts or prickly stubble compared to shave prep
- Works in 10 minutes

REF	Description
600900	Surgi-Prep Depilatory 12/bx



Surgi-Brush, Sterile

- Sterile brush used for cleaning surgical instruments in the operating room
- Double-ended nylon bristle brush
- One end of brush has 3 rows of bristles for general decontamination
- One end contains a single row of bristles for fine, delicate cleaning
- Disposable, one-time use only
- Sterile, 1-year shelf life

REF	Description
405043	Surgi-Brush, Sterile 20/bx

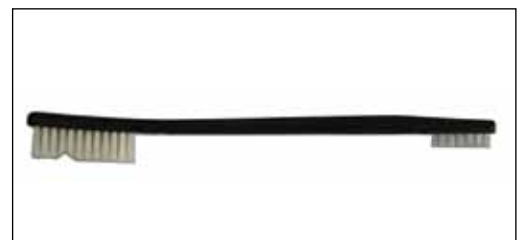

MILTEX® INSTRUMENT MAINTENANCE & CARE PRODUCTS

Cleaning & Sterilizing Steps	505-506
Instrument Stain Guide.....	507
Cleaning Products	508-511
Cleaning Brushes	511
Sharpening Stones	512
Instrument Sharpeners	513
Silitone™ Color Bands.....	513
Tip-It™ Instrument Guards.....	514
Instrument Cassettes.....	514-523
Instrument Stringers	524
Sterilization Products	525
Miltex® Sterilization and Storage Container System.....	526
Forceps	527
Sterilizing Aids.....	528

PROTECT YOUR OFFICE STAFF, YOUR PATIENTS & YOUR INVESTMENT

The cleaning and sterilization process protects your office staff and your patients. By utilizing proper instrument care and cleaning products specifically designed for your surgical instruments, you can protect your instrument investment.

Key Terms:

- Sterile - free from all living organisms.
- Sterilization - a process that destroys all forms of microorganisms, including spores, from inanimate objects.
- Disinfection - a process that eliminates many or all disease producing microorganisms, except spores, from inanimate objects.
- Cleaning - the most important step in the instrument care process. Cleaning involves the removal of adherent visible soil (blood and tissue debris) from the surface of instruments.

Key Points:

- Always follow manufacturer's directions for use for instrument processing products and equipment.
- Never process dissimilar metals together (e.g. chrome, copper, stainless steel).
- Always process instruments with box locks or hinges (e.g. scissors, needle holders, hemostats, etc.) in the open and unlocked position. Failure to do so can result in fracturing the box locks and in instrument failure.
- Always lubricate areas with "metal to metal" action after cleaning instruments. Include hinges, box locks, screws and jaws. Use a non-silicone, water-soluble surgical lubricant. Never use industrial oils or lubricants.
- Never use bleach to clean your instruments; bleach is corrosive and will void all instrument warranties.
- Chemical / cold sterilization solutions are not recommended for instruments.
- Steam (autoclaving) is the preferred method for sterilizing metal instruments.

Recommended Steps in Cleaning, Sterilization & Maintenance of Miltex® Surgical Instruments

1. HOLDING/PRESOAK

Never hold instruments in a dry container. Doing so allows blood and debris to dry onto instrument surfaces and makes cleaning more difficult. If rinsing and decontamination processes are not immediately available, pre-treat instruments or hold them in a neutral pH holding/presoak enzymatic solution after patient use but before actual cleaning. Miltex® Instrument Prep Enzyme Foam (3-760) is a ready to use foaming spray for pre-cleaning soiled instruments and scopes. Simply spray the foam on instruments until they are ready for processing. Also, Miltex® EZ-Zyme® (3-750 and 3-755) neutral pH all purpose multi-enzyme concentrate is ideal for instrument presoaking and pre-cleaning. As soon as possible, rinse and clean as follows:

2. RINSING

Always wear safety protection gear.

Immediately after surgery, remove organic materials by rinsing instruments under warm (not hot) running water. Rinse should remove most blood, fluids and tissue. Do not process dissimilar metals (stainless, copper, chrome plated, etc.) together.

Note: *Disinfection can be included to protect medical personnel from contamination during cleaning; however, protection also can be accomplished by following standard precautions by wearing appropriate PPE as promulgated by OSHA & AORN.*

3. CLEANING

All blood, dried body fluids and tissue should be completely removed from instruments prior to sterilization. Several methods for removing these materials are available.

- A. **Soak:** An enzymatic cleaner bath (soak) such as Miltex® EZ-Zyme® (3-750 and 3-755) or a solution of water and neutral pH (7) detergent such as Miltex® Surgical Instrument Cleaner (3-720, 3-725) is effective in removing organic material from instruments. Use distilled (demineralized) water, if possible. Instruments should be fully submerged for at least 10 minutes. Do not let "sharps" (scissors, knives, osteotomes, etc.) touch each other. Ensure that dissimilar metal instruments are separated. Rinse instruments under running water to remove solutions and change solutions frequently.
- B. **Ultrasonic Cleaning:** Most instrument manufacturers recommend ultrasonic cleaning as the most effective way to clean surgical instruments, particularly instruments with hinges, box locks and other moving parts.
 - All instruments must be fully submerged in an open position using distilled (demineralized) water, if possible. To prevent possible surface scratching make sure that "sharps" do not touch other instruments. Also, separate instruments of dissimilar metals.
 - Process instruments for the full recommended ultrasonic cleaning cycle. Change solution frequently or as often as the manufacturer recommends.

- Rinse instruments with water to remove the cleaning solution. Miltex® EZ-Zyme® (3-750 and 3-755) or Miltex® Surgical Instrument Cleaner (3-720, 3-725) can be safely used with all ultrasonic units.

C. **Automatic Washer Sterilizers:** Following manufacturers' recommendations, ensure that instruments are lubricated before the sterilization cycle and after the last rinse cycle.

CAUTION: Needle holders and forceps may crack if sterilized with ratchet in closed position.

D. **Manual Cleaning:** If ultrasonic cleaning is not available, observe the following steps:

- Use stiff nylon cleaning brushes (3-1000). Do not use steel wool or wire brushes except stainless steel wire brushes (3-1001) specially recommended for instrument serrated areas, bone files, burs or on stained areas of knurled handles.
- Use only neutral pH (7) detergents such as Miltex® Surgical Instrument Cleaner (3-720, 3-725). If not rinsed off properly, low pH (acidic - less than 6 pH) detergents break down the stainless protective surface resulting in pitting and/or black staining on instruments. High pH detergents (alkaline - more than 8 pH) can cause brown stains (phosphate surface deposit) which can also interfere with the smooth operation of instruments. Most brown stains are not rust and are easily removed with Miltex® Surgical Instrument Stain Remover (3-740).
- Brush delicate instruments carefully, and if possible, separate them from general instruments.
- Make sure instrument surfaces are visibly clean and are free from stains and tissue. Miltex® Surgical Instrument Stain Remover (3-740) can help remove residue stains. This is also a good time to inspect each instrument for proper function and condition.
- Check scissors' blades to ensure proper function. Blades should open and close smoothly. Test cutting performance at 3/4 length of the blade with the materials recommended below. Scissors should cut all the way to the tips. Recommended cutting test materials:
 - Fine/Delicate scissors: Surgical glove
 - Medium scissors: Single layer of stocking/cast netting
 - Large/Utility scissors: Double layer of stocking/cast netting
- Check forceps (pickups) for proper jaw alignment. Teeth must meet properly without catching.
- Check hemostats and needle holders to ensure jaw tips close in first ratchet position and that the entire jaw closes in third ratchet position. Check instruments for loose hinges and verify that they lock and unlock easily. Also check instruments for wear on jaw surfaces.

Recommended Steps in Cleaning, Sterilization & Maintenance of Miltex® Surgical Instruments

- Suction tubes should be clean inside.
- Test Biopsy Punches by punching a clean hole in 3-6 mil thick poly-bag material. If poly-bag material is not available, use tissue paper.
- Retractors should function properly.
- Cutting edge instruments and knives should be sharp and free of damage.
- After scrubbing, rinse instruments thoroughly under running water. While rinsing, open and close scissors, hemostats, needle holders and other hinged instruments to ensure that hinged areas are rinsed out and that no debris remains.

4. AFTER CLEANING

Separate dissimilar metals prior to sterilizing/autoclaving. If instruments will be stored, allow them to air-dry and store them in a clean and dry environment.

5. AUTOCLAVING

- A. **Lubricate all hinged instruments** which have any "metal to metal" action at the screw or box lock. A non-silicone, water-soluble surgical lubricant such as Miltex® Lube (3-700 or 3-705) is recommended. Do not use industrial oils or lubricants.
- B. **Sterilize instruments** either individually or in sets.
- **Individual Instruments:** Disposable paper or plastic pouches are ideal. Make sure to use a wide enough pouch for instruments with ratchet locks so instruments can be sterilized in an open (unlocked) position. Instruments locked during autoclaving can develop cracked hinges (box locks) or other problems because of heat expansion. If wrapping instruments, make sure the towel does not contain detergent residue which can stain instruments.
 - **Instrument Sets:** Unlock all instruments and sterilize in an open position. Place heavy instruments on the bottom of set (when two layers are required). Do not overload the chamber because an air pocket that hinders steam penetration may form.

CAUTION: With most portable tabletop autoclaves, unlock the door and open it no more than a crack, about 1/4" (6.4 mm). (at the end of the autoclave cycle and before the drying cycle) Then run the dry cycle for the period recommended by the autoclave manufacturer. If the autoclave door is fully opened before the drying cycle, cold air will rush into the chamber and will cause condensation on the instruments, potentially resulting in water stains or causing wet packs. Make sure autoclave filters and chambers are cleaned as recommended by the manufacturer. Miltex® Surgical Instrument Stain Remover (3-740) is effective in removing stains and in cleaning the autoclave chamber. If you have any unusual staining on your instruments after sterilization, obtain our Instrument Care DVD (3-810) or contact your local Miltex® representative.

6. CHEMICAL/COLD STERILIZATION

Most chemical/cold sterilization solutions render instruments sterile only after 10-hour immersion. This prolonged chemical action can be more detrimental to instruments than the usual 20-minute autoclave cycle. If the instruments need to be "disinfected" only, a chemical/cold sterilization soak is acceptable, as disinfection will take approximately 10 minutes or more. Check manufacturers' specifications. Also see our warning in using bleach (paragraph 3).

Keep in mind the difference between:

- Sterile - an absolute term (no living organism survives); and
- Disinfected - basically clean. Some organisms may survive. Always use the proper sterilization/cleaning technique to render the instrument in the required condition for use.

CAUTION: For instruments with tungsten carbide insert jaws, the use of chemical/cold sterilization solutions is not recommended as it may deteriorate the instrument's jaw.

We recommend these Miltex products to properly safeguard and care for your quality instruments.

REF	Description	Use During
3-760	Instrument Prep Enzyme Foam 24 oz. spray	• Holding & presoak
3-750	EZ-Zyme®, All Purpose Enzyme Cleaner Box 32 - 3/4 oz. packets	• Holding & presoak • Soak cleaning • Ultrasonic cleaning
3-755	EZ-Zyme®, All Purpose Enzyme Cleaner 1-gallon pump bottle	• Manual cleaning • Laundry presoak
3-700	Spray Lube 8 oz. spray bottle	• Before autoclaving
3-705	Surgical Instrument Lubricant 1-gallon pump bottle	
3-710	Surgical Instrument Cleaner & Lubricant 1-gallon pump bottle	• Manual cleaning • Washer/decontaminator • Ultrasonic cleaning
3-720	Surgical Instrument Cleaner 8 oz. spray bottle	• Soak cleaning • Ultrasonic cleaning • Manual cleaning
3-725	Surgical Instrument Cleaner 1-gallon pump bottle	
3-740	Surgical Instrument Stain Remover 3 oz. jar	• Stain removal
3-1000	Nylon Instrument Cleaning Brushes 3-pack	• Manual cleaning of instruments
3-1001	Stainless Steel Instrument Cleaning Brushes 3-pack	
3-800	Instrument Care System	• Complete instrument care
3-810	Instrument Care DVD	• Training personnel in the care of instruments

Instrument Stain Guide

Color	Cause of Stain	What to do
Orange-Brown to Reddish stain (looks like rust)	<p>Perform eraser test. If the stain rubs off and no pitting exists, problem is most likely from:</p> <ul style="list-style-type: none"> • Detergent residue on towels or high alkaline >8 pH detergent which leaves a phosphate surface deposit • Dried blood • Iodine or Betadine residue 	<ul style="list-style-type: none"> • Change to neutral pH detergent. We recommend Miltex® Surgical Instrument Cleaner. • Check pH of towels with litmus to verify if detergent residues are present. • Rinse the instruments in warm water for at least 30 seconds • Use a stain remover on both the instruments and autoclaves • If problem persists, consider changing to distilled or demineralized water, particularly if the local water supply is high in iron or other minerals.
Black, Brown & Pitting	<p>Subjected to an Acidic Low <6 pH substance such as:</p> <ul style="list-style-type: none"> • Low pH detergent residues on instrument surface or from towels • Exposure to other chemical compounds from "cold soaking" • Exposure to bleach 	<ul style="list-style-type: none"> • Change to neutral pH detergent. We recommend Miltex® Surgical Instrument Cleaner. • Check pH of towels with litmus to verify if detergent residues are present. • Eliminate exposure to chemicals or bleach • Rinse instruments thoroughly and consider using distilled or demineralized water, particularly if the local water supply is high in iron or other minerals. • Use stain remover on both the instruments and on autoclaves. • Eliminate any use of bleach. • If pitting remains, send the instrument back to the manufacturer for evaluation.
Rainbow or Multi-Color	<ul style="list-style-type: none"> • Heat compromised, tensile strength is compromised 	<ul style="list-style-type: none"> • Check the autoclave for proper temperature.
Bluish-Green Bluish-Black	<ul style="list-style-type: none"> • Cross contamination between dissimilar metals 	<ul style="list-style-type: none"> • Separate instruments by metal type before cleaning or autoclaving instruments.
Bluish-Gray (w/possible pitting)	<ul style="list-style-type: none"> • Improper preparation of cold sterilization solutions 	<ul style="list-style-type: none"> • Follow solution manufacturer's directions closely, particularly temperature and soak times. • Use distilled or demineralized water. • Change solution per manufacturer's instructions.
Rust	<ul style="list-style-type: none"> • Sterilizing instruments of dissimilar metals in the same cycle. • Chemicals in detergents or excess amounts of iron or other minerals from local water supply. • New instruments may be slightly magnetized during the manufacturing process. 	<ul style="list-style-type: none"> • Separate instruments by metal type prior to sterilization. • Use neutral pH detergents and change to distilled or demineralized water, particularly if the local water supply is known to contain iron or other minerals. • Wipe off as much residue as possible, leaving shiny metal underneath. Use a stain remover on both the instruments and autoclaves. • The instruments lose their magnetic property after several autoclaving sequences
Spotting Light or Dark colored	<ul style="list-style-type: none"> • Slow evaporation of water drops with mineral content • Instrument wraps and towels may contain detergent residue. 	<ul style="list-style-type: none"> • Eliminate water droplets and moisture by adhering to autoclave manufacturer's operating instructions. • Use Miltex® Stain Remover on both the instruments and autoclaves • Change to distilled or demineralized water, particularly if the local water supply is known to contain iron or other minerals. • Thoroughly wash and rinse wraps and towels with a neutral pH detergent.

MILTEX® Instrument Prep Enzyme Foam

Ready to use foaming spray for pre-cleaning soiled instruments. Ideal for applications where instrument cleaning is not immediately available. Simply spray on instruments until ready for decontamination and cleaning.

REF	Description
3-760	Instrument Prep Enzyme Foam, 24 oz. (0.71 liter) spray bottles (case of 12)



MILTEX® EZ-Zyme® All Purpose Enzyme Cleaner

Neutral pH multi-enzyme liquid concentrate ideal for instrument presoak, ultrasonic cleaning, laundry presoak and evacuation system cleaner. Ideal for cleaning hard to remove proteinaceous (mucus and tissue) and lipid (fatty) materials from the surfaces of surgical/dental instruments, linen, water submersible equipment or where mechanical scrubbing is impractical.

REF	Description
3-750	EZ-Zyme All Purpose Enzyme Cleaner, 3/4 oz. (22 ml) packets (dispenser box of 32). Contents of 1-box makes 32 gallons of solution.
3-755	EZ-Zyme All Purpose Enzyme Cleaner, 1-gallon bottle (3.78 liter). Contents of 1-gallon container makes 170 gallons of solution.



MILTEX® Surgical Instrument Cleaner

Super concentrated formula for manual and ultrasonic cleaning or for soaking of surgical instruments, accessories and glassware.

- Neutral pH
- Biodegradable
- Rinses free, leaves no residue
- Phosphate-free
- Concentrated

REF	Description
3-720	Surgical Instrument Cleaner, 8 fl. oz. (0.24 liter) bottles (case of 12). Contents of one 8 oz. bottle makes 32 gallons of solution.
3-725	Surgical Instrument Cleaner, 1-gallon bottle (3.79 liter). Contents of 1-gallon container makes 512 gallons of solution.

(Contact Distributor for availability)



MILTEX® Surgical Instrument Cleaner & Lubricant

A dual-purpose instrument cleaner and lubricant. Chemically engineered for use as a presoak or for manual cleaning, washer/decontaminators, ultrasonic cleaners and cart washers.

- Cleaner & Brighter Instruments
- Removes Stains, Blood and Mineral Deposits
- Biodegradable
- Concentrate, Lower Cost Per Use

REF	Description
3-710	1 Gallon, 128 fl. oz. (3.79 liter) (see label for concentration rates)



MILTEX® Instrument Lubricant

A water emulsible soaking agent works to extend the life of surgical instruments. Concentrated non-silicone lubricant and rust inhibitor. Use daily to keep moving parts operating smoothly.

REF	Description
3-705	1 Gallon, 128 fl. oz. (3.79 liter) (see label for concentration rates)



MILTEX® Spray Lube (Surgical Instrument Lubricant)

Pre-mixed, non-silicone and anti-corrosive formula in a ready to use 8 oz. spray pump bottle. Steam permeable and water soluble. Helps prevent spotting, staining and rusting. Lubricates instrument box locks, screw locks, scissor blades and any other metal on metal moving parts.

REF	Description
3-700	Spray Lube, 8 fl. oz. (0.24 liter) bottles (case of 12)

(Contact Distributor for availability)



MILTEX® Surgical Instrument Stain Remover

Powder formula removes stains, tarnish and restores luster to surgical instruments, autoclaves, ultrasonic cleaners, stainless steel countertops and other surfaces. Ideal for use on stainless steel, chrome, nickel, brass, copper and silver.

- Effective on instruments, autoclaves, ultrasonic cleaners or any stainless steel, tile or plated surface
- Will not harm instrument surfaces
- Easy, fast, convenient to use
- Economical - a little goes a long way



REF	Description
3-740	MILTEX Surgical Instrument Stain Remover, 3 oz. (85 grams), (case of 12)

MILTEX® Instrument Care Kit System

REF	Description
3-800	Spray Lube (3-700), Surgical Instrument Cleaner (3-720), Surgical Instrument Stain Remover (3-740), Instrument Care DVD (3-810), Nylon & Stainless Steel Brushes



MILTEX® Instrument Care Training

25-minute Instructional DVD assists practitioners and staff to properly care for instruments and to keep them in top working condition. DVD offers step-by-step guidance on handling, cleaning, rinsing, inspecting, lubricating and sterilizing surgical instruments.

Step-by-step poster provides easy instructions to clean and prepare instruments for sterilization.

Try a variety of our popular cleaning products with a H.I.P. sample box.

3-810



REF	Description
3-810	MILTEX Instrument Care DVD
SURGHIPPOST	H.I.P. Poster
SURGHIPBOX	H.I.P. Sample Box

SURGHIPBOX



SURGHIPPOST

MILTEX® Instrument Care Training DVD

25-minute Instructional DVD assists practitioners and staff to properly care for instruments and to keep them in top working condition. DVD offers step-by-step guidance on handling, cleaning, rinsing, inspecting, lubricating and sterilizing surgical instruments



REF	Description
3-810	MILTEX Instrument Care DVD

MILTEX® Nylon & Stainless Steel Brushes

- Nylon bristles for cleaning instrument box locks
- Stainless steel bristles for cleaning serrations



3-1000



3-1001



21-379

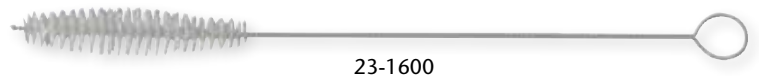

23-1600

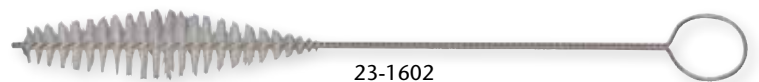

23-1602

REF	Description
3-1000	MILTEX Instrument Cleaning Brushes 7-1/4" (18.4 cm), Nylon Bristles (Set of 3)
3-1001	MILTEX Instrument Cleaning Brushes 7-1/4" (18.4 cm), Stainless Steel Bristles (Set of 3)
21-379	Stainless Wire Brush, 6-1/4" (15.9 cm)
23-1600	Cleaning Brushes for Trachea and Laryngectomy Tubes, small brush for tubes sizes 2 To 5
23-1602	Cleaning Brushes for Trachea and Laryngectomy Tubes, large brush for tubes sizes 6 To 12

Visit www.miltex.com/prodinfo/msds.aspx for Material Safety Data Sheets

Sharpening Stones

MILTEX® sharpening stones and honing oil provide clinicians with the proper tools for re-establishing an instrument's proper cutting edge. The sharpening stones are available in the most popular types and shapes: Arkansas No. 4 fine flat stone, Arkansas fine conical stone, India No. 1 fine flat stone, India No. 6 medium wedge, India No. 309 fine stone and a variety of Thompson™ Precision™ synthetic stones.

MILTEX® honing oil should be used in conjunction with the Arkansas and India stones. The honing oil helps facilitate movement across the stone, reducing friction and the problem of metallic particles embedding into the stone surface. The Thompson™ Precision™ synthetic stones do not require any lubrication. All stones should be sterilized after use.

Ref	Description	Key
STN-ARK-FLT-4	Stone, Arkansas No. 4 Flat	1
STN-ARK-CON	Stone, Arkansas Conical	2
STN-IND-FLT-1	Stone, India No. 1 Flat, Fine Grit	3
STN-IND-CON-309	Stone, India No. 309 Fine Grit	4
STN-IND-WDG-6	Stone, India No. 6 Wedge, Medium Grit	5
SP2	THOMPSON Precision Double Grit	6
SPC	THOMPSON Precision Synthetic-Coarse	7
SPM	THOMPSON Precision Synthetic-Medium	8
SPF	THOMPSON Precision Synthetic-Fine	9
DTS	Test sticks - Black	-
DTST	Test sticks - Clear	10
STN-OIL	Sharpening Oil	11



THOMPSON™ PRECISION™ Sharpeners

Thompson™ Precision™ Sharpeners do not require lubricant and may be sterilized by any method.

REF	Description
SP2	DOUBLE GRIT Precision synthetic stone
SPC	COARSE Precision synthetic stone
SPF	FINE Precision synthetic stone
SPM	MEDIUM Precision synthetic stone

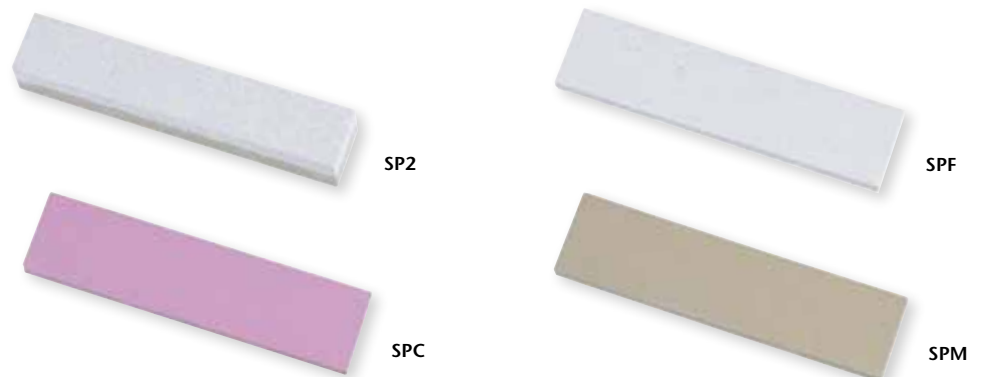

MOYCO® Instrument Sharpeners

REF	Description
560-26490	Instrument Sharpener #5 3/16"
560-26510	Instrument Sharpener #7 1/4"
560-26530	Instrument Sharpener #9 5/16"
560-26550	Instrument Sharpener #11 7/16"
560-26570	Instrument Sharpener #14 9/16"
560-26590	Instrument Sharpener #17 5/8"
560-26610	Instrument Sharpener 6/Set (one of each number)



MILTEX® Edge Scissor Sharpener

REF	Description
5-5000	MILTEX Edge Scissors Sharpener, not intended for serrated or SuperCut scissors

Ideal to freshen the blade; not intended to restore blade to new condition. For like-new sharpness, return instrument to Miltex for evaluation and maintenance. See reference section page 544 for instrument repair and sharpening information.



SILITONE™ Color Bands

- Color bands are expandable from 4 mm to 12 mm.
- Withstands temperatures up to 450° F.
- Medical grade silicone

REF	Description
VSTSA	Grey - Pack of 50 bands
VSTSB	Blue - Pack of 50 bands
VSTSD	Gold - Pack of 50 bands
VSTSG	Green - Pack of 50 bands
VSTSK	Black - Pack of 50 bands
VSTSL	Lt Blue - Pack of 50 bands
VSTSN	Brown - Pack of 50 bands
VSTSP	Pink - Pack of 50 bands
VSTSR	Red - Pack of 50 bands
VSTSU	Purple - Pack of 50 bands
VSTSW	White - Pack of 50 bands
VSTSY	Yellow - Pack of 50 bands
VST	Kit of 12 colors - 480 pieces
VSTA	Kit of 12 colors - 120 pieces (10 of each color)



Will work with ring-handled instruments!



(Exercise caution when applying color bands to instruments with sharp points.)

TIP-IT™ Instrument Guards

MILTEX® Tip-It™ Instrument Guards protect instrument tips and edges from damage during handling.

- PVC medical grade plastic
- Latex-free material
- Large holes (vented styles) to reduce vacuum and moisture build up for easy removal from instrument



REF	REF	REF	Dimension	Size Code	Color
Clear	Tinted	Solid			
Vented	Vented	Vented			
3-2501C	3-2501T	3-2501V	1/16" x 3/4" (1.6 mm x 19 mm)	1	White*
3-2502C	3-2502T	3-2502V	5/64" x 3/4" (2 mm x 19 mm)	2	Blue*
3-2503C	3-2503T	3-2503V	7/64" x 3/4" (2.8 mm x 19 mm)	3	Green*
3-2504C	3-2504T	3-2504V	1/8" x 1" (3.2 mm x 25.4 mm)	4	Red*
3-2505C	3-2505T	3-2505V	3/16" x 1" (4.8 mm x 25.4 mm)	5	Yellow*
3-2506C	3-2506T	3-2506V	13/32" x 3/4" (10.3 mm x 19 mm)	6	Maroon*
3-2507C	3-2507T	3-2507V	1/16" x 3/8" x 1" (1.6 mm x 9.5 mm x 25.4 mm)	7	Orange*
3-2508C	3-2508T	3-2508V	5/64" x 5/8" x 1" (2 mm x 16 mm x 25.4 mm)	8	Brown*
3-2509C	3-2509T	3-2509V	1/8" x 1" x 1" (3.2 mm x 25.4 mm x 25.4 mm)	9	Black*
3-2510C	3-2510T	3-2510V	Assorted, equal number of sizes plus 5	-	-

* Color does not apply to clear vented pattern

Instrument Storage Trays with Silicone Mats

REF	Description	Replacement Mats
3-200100	7" x 11" (17.8 x 27.9 cm), single layer	3200100A
3-200200	7" x 11" (17.8 x 27.9 cm), double layer	3200100A
3-200300	4" x 8" (10.2 x 20.3 cm), single layer	3200300A



3-200100



3-200200



3-200300

Instrument Storage System & Latex-Free Silicone Mats

Miltex® Instrument Storage System featuring The “Tuck-Away™” Lid

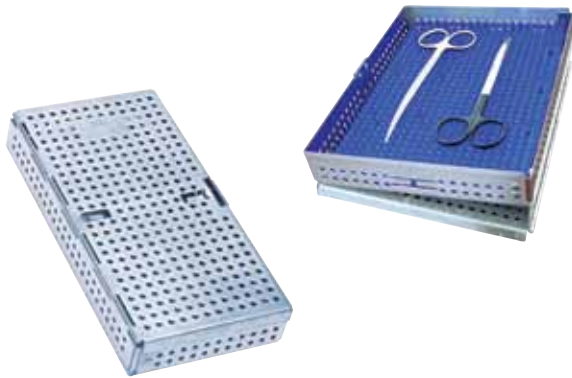

1. Unique flow-through design.
2. Medical grade silicone provides instrument retention when lid is closed.
3. Full length hinge provides stable and secure attachment to cassette.
4. Quick and easy push button release provides a positive lock when closed.
5. Pre-stamped tabs allow for custom coding of cassettes.
6. Double-hinged lid folds under for easy storage during use.
7. Self-lubricating plastic hinge pin will not corrode and provides smooth mechanical movement.
8. Passivated Stainless Steel provides corrosion protection and an aesthetic finish.

UNIVERSAL CASSETTE WITHOUT MAT

REF	Size
4-6835	6-1/2" x 6-1/4" x 1-3/16"
4-083000	8" x 3-13/16" x 1-3/16"
4-084000	8" x 4-7/8" x 1-3/16"
4-085000	8" x 6" x 1-3/16"
4-089100	8" x 9" x 1-3/16"
4-008122	8" x 11" x 1-3/16"
4-008115	8" x 11" x 2"
4-009126	9-1/8" x 13" x 1-3/16"
4-6815	15" x 8-1/4" x 1-3/16"

Latex-Free Silicone Mats

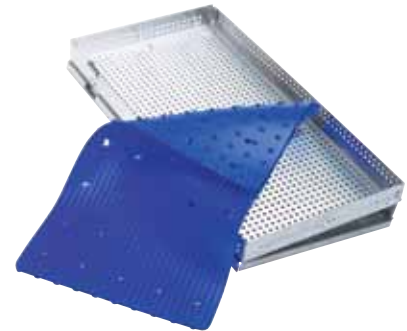

1. The raised mat (or feet) assures adhesion of the mat to the tray surface.
2. Holes positioned on mat for proper drainage.
3. Soft, cushion fingers protect your instrument investment.
4. Customized to fit perfectly into the Miltex® Cassettes.

MAT ONLY

REF	Size	Description
4-6835MAT	6-1/2" x 6-1/4"	for Cassette 4-6835
4-083000MAT	8" x 3-13/16"	for Cassette 4-083000
4-084000MAT	8" x 4-7/8"	for Cassette 4-084000
4-085000MAT	8" x 6"	for Cassette 4-085000
4-089100MAT	8" x 9"	for Cassette 4-089100
4-008122MAT	8" x 11"	for Cassette 4-008122 & 4-008115
4-009126MAT	9-1/8" x 13"	for Cassette 4-009126
4-6815MAT	15" x 8-1/4"	for Cassette 4-6815

* Please check autoclave type/chamber dimensions before choosing cassette size.

THOMPSON™ Cassettes

Thompson™ cassettes are manufactured with passivated stainless steel, feature the Thompson Tuck-Away lid* and are available in a variety of sizes and configurations to meet all storage needs.

Thompson™ cassettes are available in several options:

Single Rack Cassettes—Cassette contains a single riveted rack to accommodate various hand instruments. Several sizes are available and hold 5 to 26 instruments.

Double Rack Cassettes—Cassette contains additional removable rack for double stacking instruments.

Utility Cassettes—Cassette does not contain an instrument rack, making it ideal for ring-handled and larger sized instrumentation.

* Thompson 5 cassette features single-hinged lid.

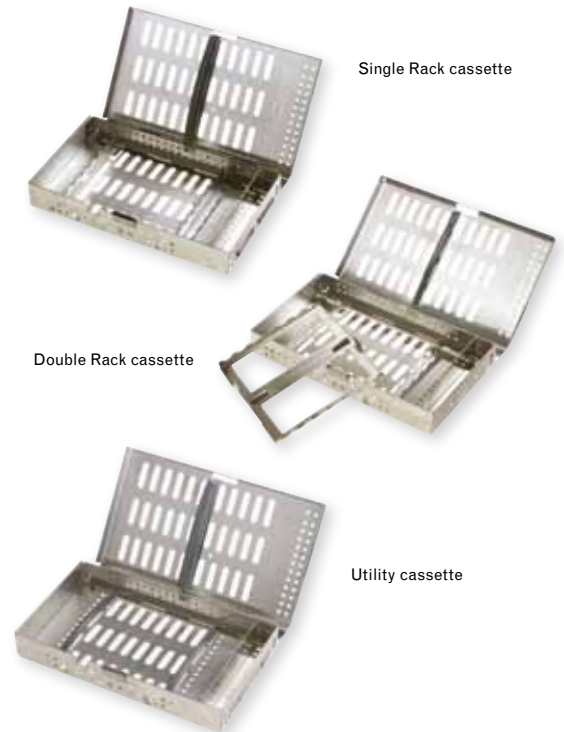

Thompson™ 5 Cassette

The Thompson™ 5 Cassette is perfect for simple procedures requiring few instruments. Its compact size features a single hinged lid, and it can hold up to 10 hand instruments with the double rack.

REF	Description	Dimensions	
		Inches	Millimeters
3-083005*	Thompson 5 Utility	8" x 3-13/16" x 1-1/8"	204 x 81 x 30
3-083105*	Thompson 5 Single Rack	8" x 3-13/16" x 1-1/8"	204 x 81 x 30
3-083210*	Thompson 5 Double Rack	8" x 3-13/16" x 1-1/8"	204 x 81 x 30

* Thompson 5 cassette features single-hinged lid.



Thompson™ 7 Cassette

The Thompson™ 7 Cassette features the double-hinged, tuck-away lid for easy storage during procedures. It can hold 7 instruments with a single rack, 14 instruments with the double rack, or larger instruments without racks.

REF	Description	Dimensions	
		Inches	Millimeters
3-084007	Thompson 7 Utility	8" x 4-7/8" x 1-1/8"	204 x 124 x 28.5
3-084107	Thompson 7 Single Rack	8" x 4-7/8" x 1-1/8"	204 x 124 x 28.5
3-084214	Thompson 7 Double Rack	8" x 4-7/8" x 1-1/8"	204 x 124 x 28.5

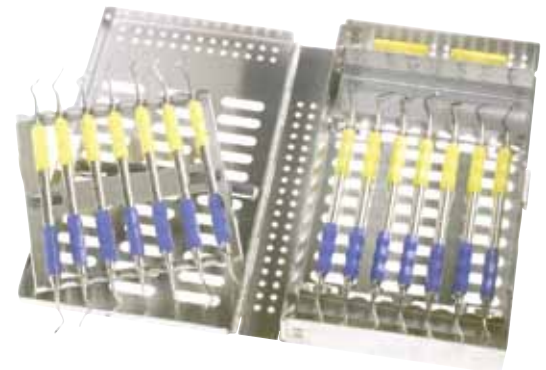

Thompson™ 9 Cassette

The Thompson™ 9 Cassette features the double-hinged, tuck-away lid for easy storage during procedures. It can hold 9 instruments with a single rack, 18 instruments with the double rack, or larger instruments without racks.

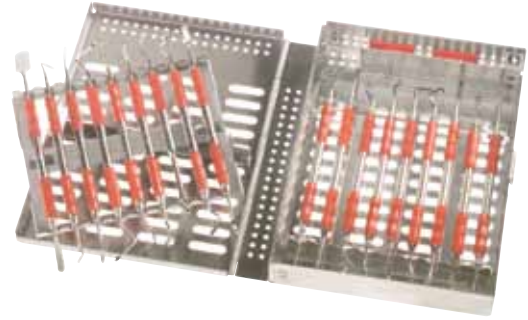

REF	Description	Dimensions	
		Inches	Millimeters
3-085009	Thompson 9 Utility	8" x 6" x 1-3/16"	204 x 154 x 30
3-085109	Thompson 9 Single Rack	8" x 6" x 1-3/16"	204 x 154 x 30
3-085218	Thompson 9 Double Rack	8" x 6" x 1-3/16"	204 x 154 x 30

Thompson™ 10 Cassette

The Thompson™ 10 Cassette can hold 10 instruments and features the double-hinged, tuck-away lid for easy storage during procedures. This Cassette is also available with lid and/or stone clips.



REF	Description	Dimensions	
		Inches	Millimeters
3-089110	Thompson 10	8" x 9" x 1-1/8"	204 x 229 x 28.5
3-089110L	Thompson 10 w/lid clips	8" x 9" x 1-1/8"	204 x 229 x 28.5
3-089110S	Thompson 10 w/ stone clip	8" x 9" x 1-1/8"	204 x 229 x 28.5
3-089110A	Thompson 10 w/ lid and stone clips	8" x 9" x 1-1/8"	204 x 229 x 28.5

Thompson™ 14 Cassette

The Thompson™ 14 Cassette can hold up to 14 instruments and features the double-hinged, tuck-away lid for easy storage during procedures. This Cassette is also available with lid and/or stone clips.



REF	Description	Dimensions	
		Inches	Millimeters
3-118114	Thompson 14	8" x 10-7/8" x 1-3/16"	204 x 276.5 x 30
3-118114L	Thompson 14 w/lid clips	8" x 10-7/8" x 1-3/16"	204 x 276.5 x 30
3-118114S	Thompson 14 w/ stone clip	8" x 10-7/8" x 1-3/16"	204 x 276.5 x 30
3-118114A	Thompson 14 w/ lid and stone clips	8" x 10-7/8" x 1-3/16"	204 x 276.5 x 30

Thompson™ 16 Cassette

The Thompson™ 16 Cassette can hold up to 16 hand instruments and features the double-hinged, tuck-away lid for easy storage during procedures. This Cassette is also available with lid and/or stone clips.

REF	Description	Dimensions	
		Inches	Millimeters
3-118116	Thompson 16	8" x 10-7/8" x 1 3/16"	204 x 276.5 x 30
3-118116L	Thompson 16 w/lid clip	8" x 10-7/8" x 1 3/16"	204 x 276.5 x 30
3-118116S	Thompson 16 w/stone clip	8" x 10-7/8" x 1 3/16"	204 x 276.5 x 30
3-118116A	Thompson 16 w/lid and stone clips	8" x 10-7/8" x 1 3/16"	204 x 276.5 x 30



Thompson™ 22 Cassette

The Thompson™ 22 Cassette is ideal for large set ups as it features individual spaces for up to 22 hand instruments. This cassette features the double-hinged, tuck-away lid for easy storage during procedures and is also available with stone and lid clips.

REF	Description	Dimensions	
		Inches	Millimeters
3-118122	Thompson 22	8" x 10-7/8" x 1 3/16"	204 x 276.5 x 30



Thompson™ 26 Cassette

The Thompson™ 26 Cassette is the largest cassette that Miltex offers and is ideal for large set ups, with individual spaces for up to 26 hand instruments. This cassette features the double-hinged, tuck-away lid for easy storage during procedures and is also available with stone and lid clips.

REF	Description	Dimensions	
		Inches	Millimeters
3-139126	Thompson 26	9-1/8" x 13" x 1-3/16"	232 x 330 x 30



SLIMLINE CASSETTES

The Thompson™ Slimline cassettes feature a single-hinged lid and reduced profile. All Slimline cassettes are manufactured from passivated stainless steel that provides an aesthetic finish and corrosion protection.

Slimline 7

The seven instrument capacity of the Slimline 7 cassette meets small cleaning and equipment requirements. Also available in extended length and deeper versions.

REF	Description	Dimensions	
		Inches	Millimeters
3-072007	Slimline 7	7" x 2-5/8" x 11/16"	178 x 67 x 17
3-082008	Slimline 7 extended	8" x 2-5/8" x 11/16"	203 x 127 x 17
STD27	Deep Slimline 7	7" x 2-5/8" x 1"	178 x 67 x 25



Slimline 14

The Slimline 14 cassette is ideal for exam, pedodontic prophylaxis/sealant, small prophylaxis and suture removal instruments. The Slimline 14 will hold up to 14 instruments, and the extended width allows ring-handled instruments to be stored along with hand instruments.

REF	Description	Dimensions	
		Inches	Millimeters
3-072014	Slimline 14	7" x 4-5/8" x 11/16"	178 x 115 x 17



SPECIALTY CASSETTES

In addition to the Slimline and Thompson™ series cassettes, Miltex also offers a variety of specialty cassettes designed for various applications.

Standard Cassette

Designed for use with Statim™ sterilizer units, the Standard cassette stores up to 14 hand instruments and also contains an instrument bin for storing large and ring-handled instruments. The Standard cassette also features a break-away lid.

REF	Description	Dimensions	
		Inches	Millimeters
STDSTAT	Standard Cassette	7" x 10-5/8" x 1-1/2"	178 x 270 x 38



Standard 8 Cassette

Designed for use with Statim™ sterilizer units, the Standard 8 cassette can store 8 hand instruments and also contains an instrument bin for storing large and ring-handled instruments. The Standard 8 cassette features the double-hinged lid.

REF	Description	Dimensions	
		Inches	Millimeters
STDSTAT8	Standard 8 Cassette	6-3/4" x 8-1/8" x 1-1/8"	171 x 206 x 29



Standard 814 Cassette

Designed for use with Statim™ sterilizer units, the Standard 814 cassette can store 14 hand instruments and also contains an instrument bin for storing large and ring-handled instruments. The Standard 814 cassette features the double-hinged lid.

REF	Description	Dimensions	
		Inches	Millimeters
STDSTAT814	Standard 814 Cassette with 14 Rack	6-3/4" x 8-1/8" x 1-1/8"	171 x 206 x 29



Small Surgical Cassette

For use with any type of customized setups. Three small surgical cassettes will fit in a Statim® autoclave.

REF	Description	Dimensions	
		Inches	Millimeters
STDBOS	Small Surgical Cassette	7" x 3" x 1-3/8"	178 x 76 x 35



Medium Surgical Cassette

This cassette is ideal for general surgery setups and can store large handled instruments that require a two inch depth. The Medium Surgical cassette features two breakaway lids, and the two compartments are hinged together for easy processing and storing various sized instruments.

REF	Description	Dimensions	
		Inches	Millimeters
STDBOM	Medium Surgical Cassette	10" x 5-1/2" x 4"	254 x 140 x 102



Large Surgical Cassette

Our largest surgical cassette has a maximum depth of two inches. The Large Surgical cassette features two breakaway lids and the two compartments are hinged together for ease of processing and storing various sized instruments.

REF	Description	Dimensions	
		Inches	Millimeters
STDBOL	Large Surgical Cassette	11" x 8" x 4"	279 x 203 x 102



Twenty-Two Instrument Cassette

This 22 instrument cassette is ideal for storing large quantities of hand instruments and additional larger instruments.

REF	Description	Dimensions	
		Inches	Millimeters
STD222	22 Instrument Cassette	8" x 10-7/8" x 1-3/16"	204 x 276.5 x 30



Orthodontic Cassette

The upright box design of the Thompson™ Orthodontic Cassettes is perfect for storing orthodontic pliers, wire cutters, scissors and wire bending instruments.

REF	Description	Dimensions	
		Inches	Millimeters
STDORTHO	Ortho Cassette	5" x 7" x 2"	127 x 178 x 51
STDORTHOS	Small Ortho Cassette	6-1/2" x 2-1/4" x 2"	165 x 57 x 51



Handpiece/Accessory Cassette

This cassette is excellent for small specialized setups, handpieces and smaller handled instruments.

REF	Description	Dimensions	
		Inches	Millimeters
3-080205	Handpiece/Accessory Cassette	8" x 2-3/16" x 1-7/16"	204 x 71 x 37



Cassette Accessories

These accessories can be used as stand-alone items or in conjunction with the Thompson™ cassettes.

Bur Holders

A bur holder can be added to hold both short and long shank burs and diamonds.

REF	Description
STDBH	12 hole bur holder
STDBH6	6 hole bur holder
STDBHS	6 hole surgical bur holder



Small Parts Box

Holds small items such as ortho brackets, long shank or lab carbide burs and rubber dam clamps. Features a hinged lid.

REF	Description	Dimensions	
		Inches	Millimeters
STDPB	Small Parts Box	1-2/3" x 1-1/3" x 1"	42 x 33 x 26



Endodontic Stands

Available in 60 and 72 hole configurations, the endodontic stand is ideal for storing all styles of hand files and rotary nickel titanium files. Can be used in conjunction with all standard Thompson™ cassettes.

REF	Description
STDES60	Endo Stand, 60 hole
STDES72	Endo Stand, 72 hole



Sterilizing Tray

REF	Description
3-499	Instrument Sterilizing Tray 10" X 6-1/2" X 2-1/2" (25.4 X 16.5 X 6.4 cm)



Mesh Bur & Diamond Holder

REF	Description
65-28	Mesh Bur and Diamond Holder, large
65-29	Mesh Bur and Diamond Holder, small



Surgical Instrument Stringers

Stainless steel MILTEX® Surgical Instrument Stringers are available in various lengths and shapes. All closed styles offer a secure locking mechanism with smooth edges designed for effortless opening and closing.

REF	Description	Length
3-60	BUNT Forceps Holder	-
3-70	Wide Side Lock Stringer 2-1/2" wide	8" (20.3 cm)
3-71	Wide Side Lock Stringer 2-1/2" wide	10" (25.4 cm)
3-72	Wide Side Lock Stringer 2-1/2" wide	12" (30.5 cm)
3-74	Wide Side Lock Stringer 2-1/2" wide	16" (40.6 cm)
3-75	Side Lock Stringer 2-1/2" wide	6" (15.2 cm)
3-76	Side Lock Stringer 2-1/2" wide	8" (20.3 cm)
3-77	Side Lock Stringer 2-1/2" wide	10" (25.4 cm)
3-78	Side Lock Stringer 2-1/2" wide	12" (30.5 cm)
3-79	Side Lock Stringer 2-1/2" wide	16" (40.6 cm)
3-80	Side Lock Stringer 2-1/2" wide	18" (45.7 cm)
3-81	Side Lock Stringer 5" wide	8" (20.3 cm)
3-82	Side Lock Stringer 5" wide	10" (25.4 cm)
3-83	Side Lock Stringer 5" wide	12" (30.5 cm)
3-84	Side Lock Stringer 5" wide	16" (40.6 cm)
3-85	Side Lock Stringer 5" wide	18" (45.7 cm)
3-86	Open U Stringer 2-1/2" wide	6" (15.2 cm)
3-87	Open U Stringer 2-1/2" wide	8" (20.3 cm)
3-88	Open U Stringer 2-1/2" wide	10" (25.4 cm)
3-89	Open U Stringer 2-1/2" wide	12" (30.5 cm)
3-90	Center Lock Stringer 2-1/2" wide	6" (15.2 cm)
3-91	Center Lock Stringer 2-1/2" wide	8" (20.3 cm)
3-92	Center Lock Stringer 2-1/2" wide	10" (25.4 cm)
3-93	Center Lock Stringer 2-1/2" wide	12" (30.5 cm)
3-94	Center Lock Stringer 2-1/2" wide	16" (40.6 cm)
3-95	Center Lock Stringer 2-1/2" wide	18" (45.7 cm)
3-96	Closed U Stringer 2-1/2" wide	6" (15.2 cm)
3-97	Closed U Stringer 2-1/2" wide	8" (20.3 cm)
3-98	Closed U Stringer 2-1/2" wide	10" (25.4 cm)
3-99	Closed U Stringer 2-1/2" wide	12" (30.5 cm)

*Items in **bold** represent the most popular patterns.

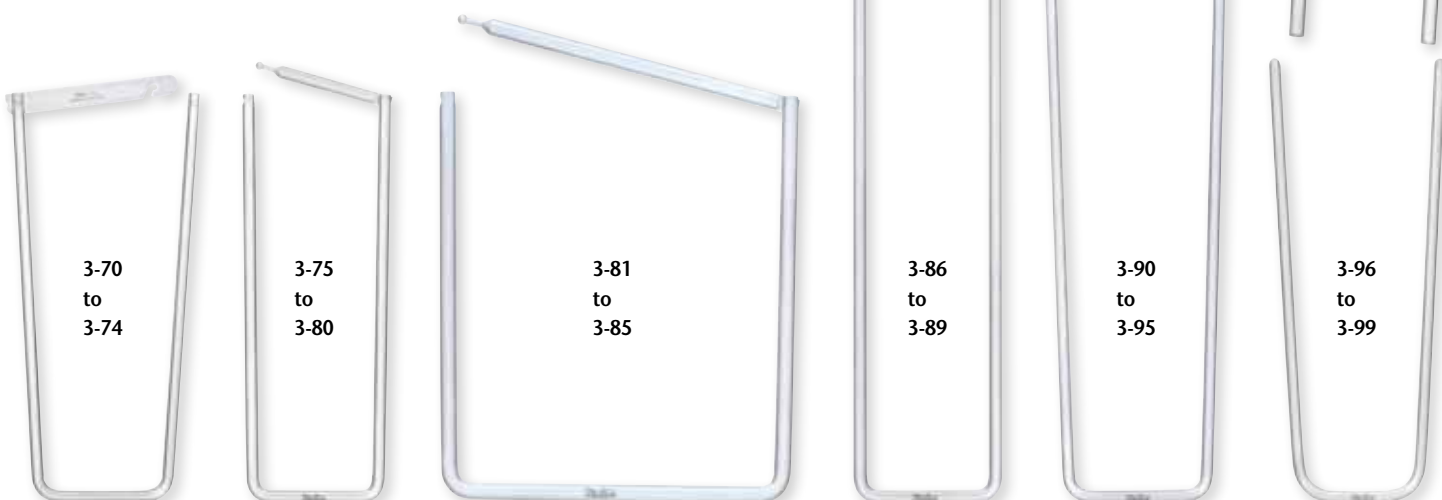
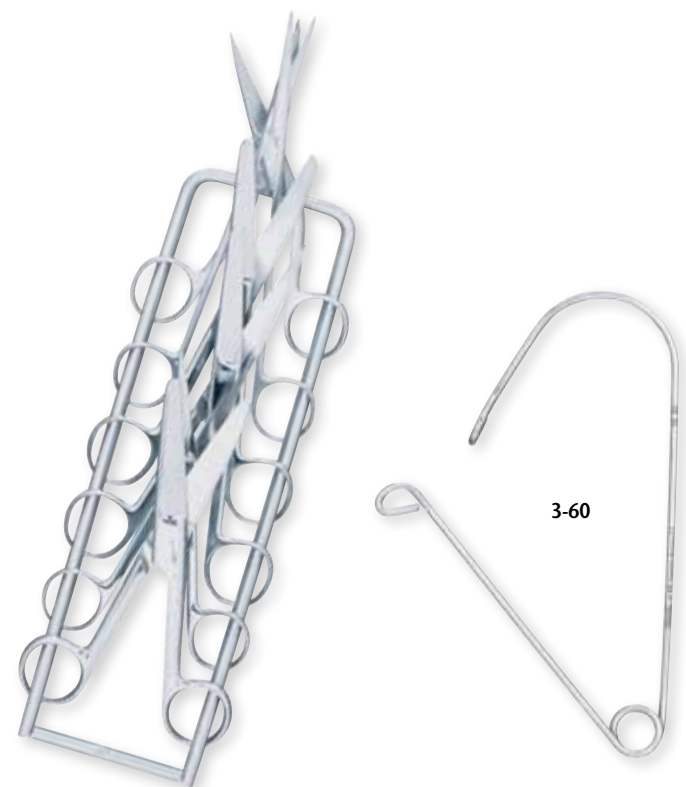

Sterilization Products

CSR Wrap

A suitable CSR wrap for steam, ETO gas and radiation sterilization processes. CSR wraps are electronically inspected for defects such as pin holes and are monitored for thickness consistency. CSR wraps are one of the lowest linting products available on the market.

Features include:

- Resists memory
- Allows steam penetration faster than muslin
- Repels water and operating room fluids
- Low linting
- Meets established standards for tensile strength and tear resistance
- Excellent barrier to airborne bacteria
- Accepts sterilization tape and labels
- Biodegradable

REF	Dimensions	Case quantity
STD1515	15" x 15"	1000/case
STD2020	20" x 20"	500/case
STD2424	24" x 24"	500/case

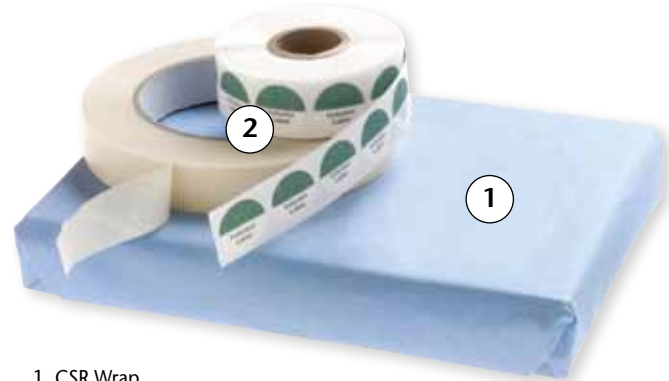

1. CSR Wrap
2. Indicator Tapes

Indicator Tapes

Indicator tapes are used to visually identify processed from unprocessed packs of instruments. MILTEX® Indicator tapes are manufactured from a specially treated crêpe paper and are coated with a high performance, pressure-sensitive adhesive that will not come undone when subjected to wet or dry heat.

Features include:

- Adheres to any kind of material
- Distinctive color-change
- Accommodates pack expansion during sterilization
- Accepts labels and writing

REF	Description
STDSTEAM	3/4" Steam, 60 yd.
STDCHEM	1/2" Chemical Vapor, 60 yd.
STDDRY	1" Dry Heat, 60 yd.

Steam Indicator Strips

Per CDC guidelines, a chemical indicator should be used with each load in conjunction with routine spore testing. The MILTEX® Steam Indicator Strip turns brown when sterilization conditions have been met and is certified for use with all steam sterilization processes. Steam Indicator strips may be maintained as a permanent record of sterilization

REF	Description
STDIND	Steam Indicator Strips, 250/bx

MILTEX® Storage Container System

Miltex has solicited the help and experience of our Customers, Surgical Distributor Partners and the finest European Manufacturers to design and construct the very best Sterilization Container available today.

We have included all of the necessary features while streamlining the selection to offer not only the best Container but one that is economical and well suited for your facility budget, instrument sterilization and storage requirements.

- Lid and bottom of container are both one-piece construction and have a uniform, anodized aluminum alloy finish
- Containers are lightweight yet durable enough to accommodate acceptable weight loads of surgical instrumentation
- Handles stop at 90° to aid lifting; low profile latch allows simple and secure lid closing
- Retention plate employs an easy “click and lock” closure over disposable, quick-to-change filter
- Dual silicone gaskets within retention plate and around perimeter ensure complete container and filter seal
- Baskets are constructed with solid wire mesh to allow for maximum ultrasonic cleaning; handles can be positioned to assist with secure and comfortable grasp for removal under sterile conditions

Wire and Perforated Baskets



Tamper Evident Locks



Identification Tags



Indicator Cards



Filters



Endoscopic Instrument Rack



Contact a Miltex Customer Service Representative at 866.854.8300 for more information on our Sterilization Containers and Accessories

Grasping & Utility Forceps

REF	Description	Type	Size
3-2	DAVIS Forceps	-	6" (15.2 cm)
3-4	DAVIS Forceps	-	10" (25.4 cm)
65-25	Grasping Forceps	non-magnetic, gold plated ends	6-1/4" (15.9 cm)
3-14	CHEATLE Forceps	-	11" (27.9 cm)
3-20	Utility Forceps	straight	8" (20.3 cm)
3-24	Utility Forceps	straight	11" (27.9 cm)



3-2
3-4



65-25



3-14



3-20
3-24

Sterilizing Aids

REF	Description	Type	Length
3-22	Utility Forceps	curved	8" (20.3 cm)
3-26	Utility Forceps	curved	11" (27.9 cm)
3-50	Spiral Rack for Surgical Needles	-	-
65-28	Mesh Bur and Diamond Holder	securely holds small items, basket 2-1/8" (5.4 cm)	6-3/4" (17.1 cm)



3-22
3-26



3-50



65-28

MILTEX® STAINLESS STEELWARE PRODUCTS

- Iodine/Medicine Cup 530
- Solution Basins..... 530
- Sponge Bowls 530
- Tumbler 530
- Cath Trays and Covers 531
- Dressing Jars and Covers 531
- Emesis Basins 531
- Forceps Jars..... 531
- Instrument Trays..... 531
- Perforated and Non-Perforated Mayo Trays 531
- Instrument Trays & Covers..... 532



STAINLESS STEELWARE

Sponge Bowls

REF	Size
3-900	4-5/16" x 2-13/64" (12 oz)
3-901	4-1/4" x 2" (16 oz)
3-902	5-5/8" x 2-9/32" (22 oz)
3-903	6-27/64" x 2-1/4" (30 oz)
3-904	6-27/64" x 2-3/4" (36 oz)
3-905	7-9/16" x 3-3/16" (47 oz)
3-906	8-3/16" x 3-5/16" (64 oz)



Iodine & Medicine Cups

REF	Description	Size
3-912	Iodine Cup	3-5/16" x 2" (6 oz)
3-913	Iodine Cup	5-1/32" x 2-23/64" (14 oz)
3-914	Medicine Cup, Graduated	2-5/32" x 2-5/32" (2 oz)



Tumbler

REF	Size
3-907	2-7/8" x 3-1/8" (7 oz)



Solution Basins

REF	Size
3-908	12-33/64" x 3-35/64" (4-1/2 qt)
3-909	13-25/32" x 4-17/32" (6 qt)
3-910	13-25/32" x 4-59/64" (7 qt)



Items in **bold** represent the most popular patterns.

STAINLESS STEELWARE

Forceps Jars

REF	Size
3-915	1-19/64" x 3-5/32"
3-916	2-3/16" x 4-21/64"
3-917	2-3/16" x 7-5/64"



Dressing Jars with Covers

REF	Size
3-953	4" x 2-5/8" (1/2 qt)
3-954	5" x 6-3/8" (2 qt)
3-955	5-7/8" x 7-5/64" (3 qt)

*cover included



Emesis Basins

REF	Size
3-918	7-7/8" x 3-3/4" x 1-19/64" (10 oz)
3-919	8-5/32" x 3-55/64" x 1-17/32" (12 oz)
3-920	9-23/32" x 4-51/64" x 1-11/16" (20 oz)



Instrument Trays

REF	Size
3-934	10" x 6-1/2" x 23/32", rolled edge
3-935	14" x 10" x 5/8", rolled edge
3-936	21-11/32" x 16-7/16" x 7/8", rolled edge



Perforated Mayo Trays

REF	Size
3-921	10" x 6-1/2" x 23/32"
3-922	14" x 10" x 5/8"
3-924	17" x 11-5/8" x 3/4"
3-925	19-11/64" x 12-23/32" x 33/64"



Non-Perforated Mayo Trays

REF	Size
3-926	10" x 6-1/2" x 23/32"
3-927	14" x 10" x 5/8"
3-929	17" x 11-5/8" x 3/4"
3-930	19-11/64" x 12-23/32" x 33/64"

Items in **bold** represent the most popular patterns.

STAINLESS STEELWARE

Instrument Trays & Covers (cover sold separately)

REF	Description	Size
3-945	Instrument Tray, Solid	12-23/32" x 10-27/64" x 2-1/2"
3-946	Instrument Tray, Solid	12-23/32" x 10-27/64" x 3-3/4"
3-947	Flat Cover, fits 3-945 & 3-946	12-29/32" x 10-35/64" x 7/16"
3-948	Instrument Tray, Solid	10-25/64" x 6-49/64" x 1-27/32"
3-949	Flat Cover, fits 3-948	10-15/32" x 6-61/64" x 7/16"

*covers sold separately



Cath Trays & Covers (cover sold separately)

REF	Description	Size
3-937	Cath Tray	8-25/32" x 4-61/64" x 1-49/64"
3-938	Cath Tray	8-7/8" x 5" x 3"
3-939	Flat Cath Cover, fits 3-937 & 3-938	8" x 5" x 7/16"
3-940	Dome Cath Cover, fits 3-937 & 3-938	8" x 5" x 7/16"
3-941	Cath Tray	8-35/64" x 3-5/64" x 1-1/2"
3-942	Dome Cath Cover, fits 3-941	8-21/32" x 3-5/16" x 19/32"
3-943	Cath Tray	15-3/4" x 2-3/4" x 2"
3-944	Dome Cath Cover, fits 3-943	15-13/16" x 3-1/32" x 29/32"

*covers sold separately



3-939 Flat Cath Cover

3-940 Dome Cath Cover

Items in **bold** represent the most popular patterns.

MILTEX® REFERENCE GUIDES

Needle Holder/Suture Guide	534-535
Fahrenheit and Centigrade Scales	536
French Catheter Scale.....	536
Autoclaving	537
Measurement Scale	537
Storage Cassette Autoclave and Ultrasonic Compatibility Chart	538-539
Dental Instrument Hand Sharpening Instructions	540-541
Instrument Warranty	542
Terms and Conditions	543
Instrument Service, Repair and Return Instructions.....	544



Recommended Suture Sizes For Miltex® Carb-N-Sert® Needle Holders

REF	DESCRIPTION	Suture Sizes														
		Smallest												Largest		
		11/0	10/0	9/0	8/0	7/0	6/0	5/0	4/0	3/0	2/0	0	1	2	3	4
8-3TC	PAR NH DEL SER JAW TC 5"	-	-	-	-	X	X	X	X	-	-	-	-	-	-	-
8-4TC	C-N-S DERF NH 4-3/4	-	-	-	-	-	X	X	X	X	-	-	-	-	-	-
8-5TC	PAR NH DEL SER JAW TC 7"	-	-	-	-	X	X	X	X	X	-	-	-	-	-	-
8-6TC	C-N-S WEBSTER NH 5	X	X	X	X	X	X	X	-	-	-	-	-	-	-	-
8-7A-TC	C-N-S WEBSTER NH 4-3/4	-	-	-	-	-	X	X	X	X	-	-	-	-	-	-
8-7TC	C-N-S WEBSTER NH 4-3/4	X	X	X	X	X	X	X	-	-	-	-	-	-	-	-
8-8A-TC	C-N-S HALSEY NH 5 SERR	-	-	-	-	X	X	X	X	-	-	-	-	-	-	-
8-8TC	C-N-S HALSEY NH 5 SMOOTH	X	X	X	X	X	X	X	-	-	-	-	-	-	-	-
8-14A-TC	C-N-S OLSEN-HEGAR NH SMTH	X	X	X	X	X	X	X	X	-	-	-	-	-	-	-
8-14TC	C-N-S OLSEN-HEGAR NH SERR	-	-	-	-	-	X	X	X	X	-	-	-	-	-	-
8-15TC	C-N-S OLSEN-HEGAR NH 5.5	-	-	-	-	-	-	X	X	X	X	X	X	X	X	X
8-16TC	C-N-S OLSEN-HEGAR NH 6.5	-	-	-	-	-	-	-	X	X	X	X	X	X	X	X
8-17TC	C-N-S OLSEN-HEGAR NH 7.5	-	-	-	-	-	-	-	X	X	X	X	X	X	X	X
8-28TC	C-N-S MATHIEU NH 5.5	-	-	-	-	-	-	-	X	X	X	X	X	X	X	X
8-30TC	C-N-S MATHIEU NH 6-1/4	-	-	-	-	-	-	-	X	X	X	X	X	X	X	X
8-40TC	C-N-S BAUMGARTNER NH 5.5	-	-	-	-	-	-	X	X	X	-	-	-	-	-	-
8-42TC	C-N-S MAYO-HEGAR NH 5	-	-	-	-	-	-	-	X	X	X	X	X	X	X	X
8-44TC	C-N-S MAYO-HEGAR NH 6	-	-	-	-	-	-	-	X	X	X	X	X	X	X	X
8-46TC	C-N-S MAYO-HEGAR NH 7	-	-	-	-	-	-	-	X	X	X	X	X	X	X	X
8-48TC	C-N-S MAYO-HEGAR NH 8	-	-	-	-	-	-	-	X	X	X	X	X	X	X	X
8-49TC	C-N-S MAYO-HEGAR NH 12	-	-	-	-	-	-	-	X	X	X	X	X	X	X	X
8-50A-TC	C-N-S CRILE-WOOD NH 6 SMT	X	X	X	X	X	X	X	-	-	-	-	-	-	-	-
8-50TC	C-N-S CRILE-WOOD NH 6 SER	-	-	-	-	-	X	X	X	X	-	-	-	-	-	-
8-51TC	C-N-S CRILE-WOOD NH 7	-	-	-	-	-	X	X	X	X	-	-	-	-	-	-
8-52TC	C-N-S CRILE-WOOD NH 8	-	-	-	-	-	-	-	X	X	X	X	X	X	X	X
8-53TC	C-N-S CRILE-WOOD NH 9	-	-	-	-	-	-	-	X	X	X	X	X	X	X	X
8-55TC	C-N-S CRILE-WOOD NH 10-1/	-	-	-	-	-	-	-	X	X	X	X	X	X	X	X
8-57TC	C-N-S CRILE-WOOD NH 12	-	-	-	-	-	-	-	X	X	X	X	X	X	X	X
8-62TC	C-N-S COOLEY NH X-DEL 6	-	-	-	-	-	X	X	X	X	-	-	-	-	-	-
8-63TC	C-N-S COOLEY NH XDEL 6-3/	-	-	-	-	-	X	X	X	X	-	-	-	-	-	-
8-65TC	C-N-S INTRACARD NH 5 DEL	-	-	-	-	-	X	X	X	X	-	-	-	-	-	-
8-66TC	C-N-S INTRACARD NH 6 DEL	-	-	-	-	-	X	X	X	X	-	-	-	-	-	-
8-67TC	C-N-S INTRACARD NH 7 DEL	-	-	-	-	-	X	X	X	X	-	-	-	-	-	-
8-69TC	C-N-S INTRACARD NH 9 DEL	-	-	-	-	-	X	X	X	X	-	-	-	-	-	-
8-81TC	C-N-S NEW ORLEANS NH 7	-	-	-	-	-	-	-	X	X	X	X	X	X	X	X
8-82TC	C-N-S JULIAN N.H. STR	-	-	-	-	-	-	-	X	X	X	X	X	X	X	-
8-83TC	C-N-S JULIAN N.H. CVD	-	-	-	-	-	-	-	X	X	X	X	X	X	X	-
8-96TC	C-N-S SAROT NH 7-1/8	-	-	-	-	-	-	-	X	X	X	X	X	X	X	X
8-100TC	C-N-S HEANEY NH 8.5	-	-	-	-	-	-	-	X	X	X	X	X	X	X	X
8-101TC	C-N-S RYDER NH 5	-	-	-	-	-	X	X	X	X	-	-	-	-	-	-
8-102TC	C-N-S STRATTE NH 9	-	-	-	-	-	-	-	X	X	X	X	X	X	X	X
8-103TC	C-N-S RYDER NH 6	-	-	-	-	-	X	X	X	X	-	-	-	-	-	-
8-104TC	C-N-S RYDER NH 7	-	-	-	-	-	X	X	X	X	-	-	-	-	-	-
8-105TC	C-N-S RYDER NH 8	-	-	-	-	-	X	X	X	X	-	-	-	-	-	-
8-106TC	C-N-S RYDER NH 9	-	-	-	-	-	X	X	X	X	-	-	-	-	-	-
8-107TC	C-N-S RYDER NH 10-1/4	-	-	-	-	-	X	X	X	X	-	-	-	-	-	-
8-114TC	C-N-S SAROT NH 10-1/2	-	-	-	-	-	-	-	X	X	X	X	X	X	X	X
8-130TC	C-N-S MASSON NH 10-1/2	-	-	-	-	-	-	-	X	X	X	X	X	X	X	X
8-134TC	C-N-S WANGENSTEEN NH 103/	-	-	-	-	-	-	-	X	X	X	X	X	X	X	X
8-706TC	C-N-S WEBSTER NH QUICK-RE	X	X	X	X	X	X	-	-	-	-	-	-	-	-	-
8-744TC	C-N-S MAYO-HEG NH QUICK-R	-	-	-	-	-	-	-	X	X	X	X	X	X	X	X
8-746TC	C-N-S MAYO-HEG NH QUICK-R	-	-	-	-	-	-	-	X	X	X	X	X	X	X	X
8-748TC	C-N-S MAYO-HEG NH QUICK-R	-	-	-	-	-	-	-	X	X	X	X	X	X	X	X
8-750TC	C-N-S CRILE-WD NH QUICK-R	-	-	-	-	-	X	X	X	X	-	-	-	-	-	-
8-751TC	C-N-S CRILE-WD NH QUICK-R	-	-	-	-	-	-	-	X	X	X	X	X	X	X	X
8-752TC	C-N-S CRILE-WD NH QUICK-R	-	-	-	-	-	-	-	X	X	X	X	X	X	X	X
8-753TC	C-N-S CRILE-WD NH QUICK-R	-	-	-	-	-	-	-	X	X	X	X	X	X	X	X
18-1816TC	C-N-S CASTR-VJO NH RND	X	X	X	X	X	X	-	-	-	-	-	-	-	-	-
18-1828A-TC	C-N-S CASTR-VJO NH SERR	X	X	X	X	X	X	-	-	-	-	-	-	-	-	-
18-1828TC	C-N-S CASTR-VJO NH SMTH	X	X	X	X	X	X	-	-	-	-	-	-	-	-	-
18-1832A-TC	C-N-S CASTROV NH CVD SERR	X	X	X	X	X	X	-	-	-	-	-	-	-	-	-
18-1832TC	C-N-S CASTROV NH CVD SMTH	X	X	X	X	X	X	-	-	-	-	-	-	-	-	-
17-1090TC	C-N-S JACOBSON NH 7 STR	X	X	X	X	X	-	-	-	-	-	-	-	-	-	-
17-1091TC	C-N-S JACOBSON 7 CVD	X	X	X	X	X	-	-	-	-	-	-	-	-	-	-
17-1092TC	C-N-S JACOBSON NH 8.5 STR	X	X	X	X	X	-	-	-	-	-	-	-	-	-	-

Recommended Suture Sizes For Miltex® Stainless Steel Needle Holders

REF	DESCRIPTION	Suture Sizes														
		Smallest		9/0	8/0	7/0	6/0	5/0	4/0	3/0	2/0	0	1	2	3	Largest
		11/0	10/0													
8D-36	GARDNER (HALSEY) NH 5 SER	-	-	-	-	-	-	-	X	X	X	X	-	-	-	-
8-96	SAROT NH 7-1/8	-	-	-	-	-	-	-	X	X	X	X	X	X	X	X
8-94	CRILE NH 6	-	-	-	-	-	-	-	X	X	X	X	X	X	X	X
8-80	NEW ORLEANS NH 7	-	-	-	-	-	-	-	-	-	X	X	X	X	X	X
8-8	HALSEY NH 5	X	X	X	X	X	X	-	-	-	-	-	-	-	-	-
8-7	WEBSTER NH 4-3/4 DEL.	X	X	X	X	X	X	-	-	-	-	-	-	-	-	-
8-6	WEBSTER NH 5	X	X	X	X	X	X	-	-	-	-	-	-	-	-	-
8-53	CRILE-WOOD NH 9	-	-	-	-	-	-	-	X	X	X	X	X	X	X	X
8-52	CRILE-WOOD NH 8	-	-	-	-	-	-	-	X	X	X	X	X	X	X	X
8-51	CRILE-WOOD NH 7	-	-	-	-	-	-	-	X	X	X	X	X	X	X	X
8-50	CRILE-WOOD NH 6	-	-	-	-	-	-	-	X	X	X	X	X	X	X	X
8-48	MAYO-HEGAR NH 8	-	-	-	-	-	-	-	X	X	X	X	X	X	X	X
8-46	MAYO-HEGAR NH 7	-	-	-	-	-	-	-	X	X	X	X	X	X	X	X
8-44	MAYO-HEGAR NH 6	-	-	-	-	-	-	-	X	X	X	X	X	X	X	X
8-42	MAYO-HEGAR NH 5	-	-	-	-	-	-	-	X	X	X	X	X	X	X	X
8-40	BAUMGARTNER NH 5.5	-	-	-	-	-	-	X	X	X	X	-	-	-	-	-
8-4	DERF NH 4-3/4	-	-	-	-	-	-	X	X	X	X	-	-	-	-	-
8-32	MATHIEU NH 7.5	-	-	-	-	-	-	-	X	X	X	X	X	X	-	-
8-30	MATHIEU NH 6-1/4	-	-	-	-	-	-	-	X	X	X	X	X	X	-	-
8-28	MATHIEU NH 5.5	-	-	-	-	-	-	-	X	X	X	X	X	X	-	-
8-26	BOYNTON NH 5 DEL.	-	X	X	X	-	-	-	-	-	-	-	-	-	-	-
8-2	COLLIER NH 5	-	-	-	-	-	X	X	X	X	-	-	-	-	-	-
8-17	OLSEN-HEGAR N.H. 7-1/4	-	-	-	-	-	-	-	X	X	X	X	X	X	X	X
8-16	OLSEN-HEGAR NH 6.5	-	-	-	-	-	-	-	X	X	X	X	X	X	X	-
8-15	OLSEN-HEGAR NH 5.5	-	-	-	-	-	-	-	X	X	X	X	X	X	-	-
8-14A	OLSEN-HEGAR NH 4-3/4 SMTH	-	-	-	-	-	X	X	X	-	-	-	-	-	-	-
8-14	OLSEN-HEGAR NH 4-3/4 SERR	-	-	-	-	-	X	X	X	-	-	-	-	-	-	-
8-136	WANGENSTEEN NH 10-1/2	-	-	-	-	-	-	-	X	X	X	X	X	X	X	X
8-134	WANGENSTEEN NH 10-3/4	-	-	-	-	-	-	-	X	X	X	X	X	X	X	X
8-130	MASSON NH 10-1/2	-	-	-	-	-	-	-	X	X	X	X	X	X	X	X
8-122	FINO NH 10-1/2	-	-	-	-	-	-	-	-	-	X	X	X	X	X	X
8-12	NEIVERT NH 5	X	X	X	X	X	X	-	-	-	-	-	-	-	-	-
8-114	SAROT NH 10-1/2	-	-	-	-	-	-	-	X	X	X	X	X	X	X	X
8-102	STRATTE NH 9	-	-	-	-	-	-	-	X	X	X	X	X	X	X	X
8-100	HEANEY NH 8-1/4	-	-	-	-	-	-	-	X	X	X	X	X	X	X	X
18-1833	CASTR-VJO NH CVD W/LOCK D	-	-	-	-	X	X	X	X	X	X	X	X	X	X	-
18-1832	CASTR-VJO NH CVD W/LOCK	-	-	-	-	X	X	X	X	X	X	X	X	X	X	-
18-1831	CASTR-VJO NH STR W/LOCK D	-	-	-	-	X	X	X	X	X	X	X	X	X	X	-
18-1828	CASTR-VJO NH STR W/LOCK	-	-	-	-	X	X	X	X	X	X	X	X	X	X	-
18-1824	CASTR-VJO NH CVD WO LOCK	-	-	-	-	X	X	X	X	X	X	X	X	X	X	-
18-1820	CASTR-VJO NH STR WO LOCK	-	-	-	-	X	X	X	X	X	X	X	X	X	X	-
17-980	MICRO NH 71/8 STR JAW W/0	-	-	-	X	X	X	X	X	-	-	-	-	-	-	-
17-1025	MICRO NH 71/8 CVD JAW W/L	-	-	-	X	X	X	X	X	-	-	-	-	-	-	-
17-1024	MICRO NH 7-1/8 STR JAW W/	-	-	-	X	X	X	X	X	-	-	-	-	-	-	-
17-1020	MICRO NH 51/8 CVD JAW W/L	-	-	-	X	X	X	X	X	-	-	-	-	-	-	-
17-1010	MICRO NH 71/8 CVD JAW WO	-	-	-	X	X	X	X	X	-	-	-	-	-	-	-
17-1000	MICRO NH 51/8 CVD JAW WO	-	-	-	X	X	X	X	X	-	-	-	-	-	-	-











Recommended Suture Sizes For Miltex® Ceram-A-Grip® Needle Holders

REF	DESCRIPTION	Suture Sizes														
		Smallest		9/0	8/0	7/0	6/0	5/0	4/0	3/0	2/0	0	1	2	3	Largest
		11/0	10/0													
8-4CG	C-A-G DERF NH 4-3/4	-	-	-	-	-	X	X	X	X	-	-	-	-	-	-
8-6CG	C-A-G WEBSTER NH 5	X	X	X	X	X	X	-	-	-	-	-	-	-	-	-
8-7CG	C-A-G WEBSTER NH 4-3/4	X	X	X	X	X	X	-	-	-	-	-	-	-	-	-
8-8CG	C-A-G HALSEY NH SMTH	X	X	X	X	X	X	-	-	-	-	-	-	-	-	-
8-15CG	C-A-G OLSEN-HEGAR 5.5	-	-	-	-	-	-	-	X	X	X	X	X	X	-	-
8-16CG	C-A-G OLSEN-HEGAR 6.5	-	-	-	-	-	-	-	X	X	X	X	X	X	X	-
8-40CG	C-A-G BAUMGARTNER 5.5	-	-	-	-	-	X	X	X	X	-	-	-	-	-	-
8-42CG	C-A-G MAYO-HEGAR NH 5	-	-	-	-	-	-	-	X	X	X	X	X	X	X	X
8-44CG	C-A-G MAYO-HEGAR NH 6	-	-	-	-	-	-	-	X	X	X	X	X	X	X	X
8-46CG	C-A-G MAYO-HEGAR NH 7	-	-	-	-	-	-	-	X	X	X	X	X	X	X	X
8-48CG	C-A-G MAYO-HEGAR NH 8	-	-	-	-	-	-	-	X	X	X	X	X	X	X	X
8-50CG	C-A-G CRILE-WOOD NH 6	-	-	-	-	-	X	X	X	X	-	-	-	-	-	-
8-51CG	C-A-G CRILE-WOOD NH 7	-	-	-	-	-	X	X	X	X	-	-	-	-	-	-
8-52CG	C-A-G CRILE-WOOD NH 8	-	-	-	-	-	-	-	X	X	X	X	X	X	X	X



Conversion Charts

French measurement refers to a unit of distance used for measuring the diameters of small tubes such as catheters, sounds, bougies, suction tubes and uterine dilators. One French is equal to 1/3 millimeter (about 13.123 mils).

French Catheter Scale							
MM	INCH		FR	MM	INCH	FR	
1	.039	◦	3	5.7	.223		17
1.35	.053	◦	4	6.0	.236		18
1.67	.066	◦	5	6.3	.249		19
2.0	.079	◦	6	6.7	.263		20
2.3	.092	◦	7	7.3	.288		22
2.7	.105	◦	8	8.0	.315		24
3.0	.118	◦	9	8.7	.341		26
3.3	.131	◦	10	9.3	.367		28
3.7	.144	◦	11	10.0	.393		30
4.0	.158	◦	12	10.7	.419		32
4.3	.170	◦	13	11.3	.445		34
4.7	.184	◦	14				
5.0	.197	◦	15				
5.3	.210	◦	16				

Fahrenheit and Centigrade Scales	
F.	C.
500	260
401	205
392	200
383	195
374	190
356	180
347	175
338	170
329	165
320	160
311	155
302	150
284	140
275	135
266	130
248	120
239	115
230	110
212	100
203	95
194	90
176	80
167	75
140	60
122	50
113	45
105	40.56
104	40
100	37.8
98.5	36.9
95	35
86	30
77	25
68	20
50	10
41	5
32	0
23	-5
14	-10
+5	-15
-4	-20
-13	-25
-22	-30
-4	-40
-76	-60

1° F. = 5/9 ° C.
 1.8° F. = 1° C.
 3.6° F. = 2° C.
 4.5° F. = 2.5° C.
 5.4° F. = 3° C.



Measurement Conversion Scale

Conversion Scale		
To Convert From	To	Multiply By
Ounces (AVDP.)	Grams	28.349523
Ounces (APOTH.)	Grams	31.103486
Grains	Grams	0.06479891
Pounds (AVDP.)	Kilograms	0.45359237
Inches	Centimeters	2.54
Feet	Meters	0.3048
Yards	Meters	0.9144
Ounces (U.S. Fluid)	Cubic Centimeters	29.573730
Ounces (British Fluid)	Cubic Centimeters	28.41305
Quarts (U.S. Fluid)	Liters	0.9463264
Cubic Inches	Cubic Centimeters	16.387064
Grams	Grains	15.432358
Grams	Ounces (AVDP.)	0.35273962
Grams	Ounces (APOTH.)	0.32150737
Kilograms	Pounds (AVDP.)	2.2046226
Millimeters	Inches	0.039370079
Centimeters	Inches	0.39370079
Meters	Feet	3.2808399
Cubic Centimeters	Cubic Inches	0.61023744
Cubic Centimeters (Fluid)	Ounces (U.S. Fluid)	0.33814023
Liters	Quarts (U.S. Fluid)	1.056718

Autoclaving

Instruments are normally autoclaved with saturated steam at 134° Celsius, although a temperature of 121° Celsius may be used in conjunction with a longer exposure time on instruments with limited thermostability.

The sterilization procedure used on your instruments must be in compliance with sterilization standards and must be appropriate for the instruments to be sterilized. The packing materials used in the sterilization procedure must also be suitable for the procedure selected and must comply with all relevant quality sterilization standards.

Dental instruments can be treated similarly to surgical instruments in the sterilization process.

Steam Autoclave Guide

Temperature	121-134° C
Pressure	30 PSI
Cycle Time	Approximately 30 minutes; must maintain noted temperature & pressure level for 15 minutes
Sterilant	Steam
Sterilization Range	Stainless steel, glassware, Selected rigid materials

Be sure to refer to your autoclave manual or autoclave manufacturer for proper usage instructions.

Dental Hand Instrument Sharpening Instructions

How to sharpen instruments?

The sharpening stone moves while the instrument is held stationary.

1. Place 1 drop of Miltex® Honing Oil on the Arkansas or India sharpening stone. No lubrication is required on ceramic stones. (Apply oil only if it was not previously applied to stone or if more lubrication is needed).
2. Hold the instrument in one hand while applying the stone to the lateral surface of the point of the instrument, forming a 110° angle with the face of the blade of the instrument.
3. Position the sharpening stone to contact the heel of the instrument blade and work toward the tip, keeping the stone in contact with the blade throughout the sharpening procedure
4. Move the sharpening stone up and down along the instrument with short strokes, placing more pressure on the down stroke. (Continue to keep the instrument still).
5. Finish sharpening the instrument with a down stroke, which prevents a rough edge from forming on the instrument.
 - a) Metal particles and lubricant will accumulate on the blade and can be wiped off with sterile gauze. (This accumulation is also an indication that the proper angulation was maintained during the sharpening process).
6. For sickle scalars, continue sharpening to the point of the scaler. For curettes, continue around the toe to maintain its curved shape.
7. Test for sharpness with a plastic Miltex® test stick. If the blade of the instrument is sharp, it will grab into the stick. If the blade is dull, it will slide over the stick without grabbing. If the blade of the instrument is still dull after sharpening, re-evaluate the angle of the stone and repeat the sharpening procedure (steps 2-6).
8. Repeat the procedure to sharpen the other side of sickle scalars and universal curettes.



STEP 1



STEPS 2 & 4



STEP 7

Dental Hand Instrument Sharpening Instructions



ROUNDING THE TOE
CURVED SICKLE



ROUNDING THE TOE
STRAIGHT SICKLE

Rounding the toe of currettes

1. Place 1 drop of Miltex® Honing Oil on the Arkansas or India sharpening stone. No lubrication is required on ceramic stones. (Apply oil only if it was not previously applied to stone or if more lubrication is needed).
2. Place the sharpening stone at a 45° angle to the face of the instrument.
3. Using downward strokes, rotate the sharpening stone around the toe of the instrument.

Sharpening the face of dental instruments

Sharpening the face of periodontal instruments is only recommended for removing a roughened edge. Extraneous grinding of the face can weaken the instrument blade.

For currettes and curved sickles, use a conical or cylindrical sharpening stone (Arkansas Conical, part number: STN-ARK-CON or India No. 309 part number: STN-IND-CON-309)

1. Place 1 drop of Miltex® Honing Oil on the Arkansas or India sharpening stone. No lubrication is required on ceramic stones.

(Apply oil only if it was not previously applied to stone or if more lubrication is needed).

2. Place the stone at the junction between the face of the instrument and the shank of the instrument.
3. Roll the sharpening stone across the face of the instrument, moving toward the toe of the instrument.
4. Use as few strokes as possible and light, even pressure.

For straight sickle instruments, use a flat sharpening stone (Arkansas No. 4 flat, part number: STN-ARK-FLT-4 or India No.1, part number STN-IND-FLT-1).

1. Place 1 drop of Miltex® Honing Oil on the Arkansas or India sharpening stone. No lubrication is required on ceramic stones.

(Apply oil only if it was not previously applied to stone or if more lubrication is needed).

2. Place the stone on the entire facial surface of the instrument.
3. Move the stone across the facial surface of the instrument in a back and forth motion.
4. Use as few strokes as possible and light, even pressure.

INSTRUMENT WARRANTY

Miltex® and Padgett® Instruments are guaranteed to be free from material defects. Our Guarantee also includes a commitment to the very highest standards of quality craftsmanship which will be employed in the manufacture of each and every Instrument. If either of these high standards are not met by Miltex, our customer may return the Instrument to be repaired or replaced at our discretion and at no charge to the customer.

PRODUCT WARRANTY

Miltex also offers to our customers an array of complementary surgical and dental products. These are held to the same high standards of material and workmanship as our instruments. However, all of these quality products are also provided with a limited one-year warranty.

- Chiropractic and Auto-Surgical Mallets
- Laparoscopic Instruments and Scopes
- Instrument Containers and Cassettes
- Chrome Instruments
- Electrosurgical Instrumentation
- Electrical Devices
- Podiatry Nipper/Splitter Springs
- Fiber Optic Instruments / Accessories

REPAIR WARRANTY

If for any reason a customer is dissatisfied with a Miltex® repair, we guarantee to replace or again repair the product at no charge if the instrument is returned within 30 days. We request that our customers assist us in protecting our employees by returning cleaned and sterilized instruments for repair.

WARRANTY STIPULATIONS

Our Warranty is effective from the date-of-purchase only from either Miltex or an Authorized Miltex Distributor. The warranty remains in effect if the Instrument or Product is used for its intended surgical or dental purpose as well as continuous and proper care of the Instrument or Product is maintained.

OTHER WARRANTY INFORMATION FOR OUR CUSTOMERS

- We ask our customers to use only the Miltex® Repair Services for our products so the warranty remains in effect.
- We love to meet your unique or special needs with custom produced products. However, these are not returnable.
- Miltex offers excellent Care and Cleaning products for our instruments. Please use these products or other appropriate cleaning products to properly maintain your instrument as a valuable asset. Proper care and cleaning of your instruments is also a requirement to maintain the instrument warranty.
- We strongly recommend that you use the appropriate instrument for the identified clinical need. Misuse of instruments can cause damage to the instrument or product and will void the warranty.
- Hurricanes, fires or other disasters will void the warranty of your instruments.

A FINAL & REQUISITE STATEMENT

As set forth in these Terms, Conditions, Policy and Warranty, Miltex makes no other representations, either expressed or implied, which supersede the above descriptions. In no event will Miltex be liable for any incident, special or exemplary damages or loss of profits in connection with the use of a Miltex® Instrument or Product.

TERMS & CONDITIONS

ORDERS AND QUOTATIONS

Contact Miltex, Inc., 589 Davies Drive, York, PA 17402 or call toll free 1-866-854-8300 to place orders and for formal quotations. Orders may also be placed via toll-free fax 1-866-854-8400, on our web site at www.miltex.com (registered authorized distributors only) or through Electronic Data Interchange (EDI).

TERMS

All invoices are payable net 30 days from date of invoice.

FREIGHT

Prices quoted are FOB factory. Prices are subject to change without notice.

Orders will be shipped via the carrier of Miltex's choice unless the distributor requests a particular service. If a special request is made, an additional handling charge will be included on the invoice to cover the resulting processing and carrier charges.

ACCEPTANCE

All orders are subject to approval by Miltex.

Miltex herewith reserves the right to alter the design or form of any product or to discontinue any product prior to the date of delivery without incurring any obligation to make such changes in any items previously purchased, whether or not delivered.

CREDIT

Miltex reserves the right to refuse orders, suspend credit and cancel unfulfilled orders when credit conditions of a customer warrant such action.

SHIPMENTS, DAMAGES, & SHORTAGES IN TRANSIT

Shipment schedules are approximate and are as accurate as conditions permit on the date the schedules are provided. Miltex assumes no responsibility or liability for unforeseen delays in making delivery. When signing for receipt of goods, all visible damage and/or shortages to cartons must be indicated on the carrier delivery receipt so that a claim may be filed with the carrier. The customer shall inspect all items upon arrival and give written notice to Miltex of any claim for a shortage or non-conformance within 7 days after receipt of shipment.

Miltex may make partial shipments, which the distributor shall accept and pay for at the prices specified on maturity of the invoice involved.

RETURN MATERIALS POLICY

A Returned Materials Authorization number (RMA) must be obtained prior to returning product to Miltex. Product returned without an RMA number will be returned directly to the distributor, at our cost, with a letter of explanation. Returns can only be granted and authorized by obtaining an RMA number from Miltex customer service at toll free 1-866-854-8300.

Issue of an RMA number should not be interpreted as a final credit to your customer account. Miltex reserves the right to evaluate incoming returns prior to issuing any customer credit.

There will be a 15% restocking charge for product returned after 60 days but before 120 days after receipt of shipment. Product must be returned unused in its original packaging. No returns will be accepted after 120 days after receipt of shipment. Non-returnable products received by Miltex will be returned directly to the distributor, at our cost, with a letter of explanation. Sterile products which have been opened, returned out of the original package or returned after the sterile expiration date are not returnable.

Discontinued products, medicament products, private labeled, custom made, custom etched or neutralized products are not returnable.

Broken instruments noted as 'Sharps' have special handling and return requirements. Call customer service toll free 1-866-854-8300 for information regarding special shipping and handling requirements.

INSTRUMENT SERVICE, REPAIR AND RETURN INSTRUCTIONS

Miltex, Inc. offers you the expertise and convenience of operating its own in-house Service and Repair Department. Please follow our simple return instructions to ensure all returns and repairs are processed correctly and in a timely manner. Your instruments are as important to us as they are to you.

Please contact our Customer Service Department at 1.866.854.8300 or repairs@miltex.com to obtain a Return Material Authorization (RMA) number. The RMA number is required before instruments are returned for repair.

Be prepared to provide the following information:

- Customer account number
- Customer purchase order number

IMPORTANT: Any instrument sent to Miltex, Inc. without an RMA number will be returned to sender without being evaluated or repaired.

Once you have received your RMA number, repairs should be sent to:

Miltex, Inc.
Repair Department
589 Davies Drive
York, PA 17402 USA
RMA #: _____ (needed on outside of shipping box)

How to Package and Ship Instruments:

- Miltex, Inc. cannot accept instruments that have not been properly cleaned and sterilized.
- Include the RMA number, customer account number, customer purchase order number and reason for repair.
- Include all contact information (name, address, phone number, email address).
- Wrap instruments to protect them during transit.
- Use a common carrier (FedEx, UPS).
- Insure the package, and keep a record of the tracking number.

NOTE: We cannot accept instruments for repair at conventions or trade shows. Miltex, Inc. representatives cannot accept instruments for repair. Please follow the instructions above.

If you have questions or comments, contact Customer Service at 1.866.854.8300 or repairs@miltex.com.





10% OFF

REPAIR 5 INSTRUMENTS, RECEIVE A 10% DISCOUNT

Send in 5 or more repairable instruments and receive 10% off the total price of the repair!

For end-users only. Does not apply to government, institutional, or dealer repairs. To obtain your 10% discount, mail this voucher along with product (5 or more repairable instruments) for repair to Miltex, Inc. Attn: Return/Repair Department, 589 Davies Drive, York, PA 17402 (1-866-854-8300). Call for RMA. **Discount void if not accompanied by this voucher and 5 or more repairable instruments.**



10% OFF

10% OFF

10% OFF

A

ABBEY Needle Holder.....	118
Abdominal Retractor.....	149
Abdominal Scissors.....	23
ADSON Bayonet Dressing Forceps 55, 66, 328	
ADSON Dressing Forceps.....	54, 61
ADSON Dressing/Tissue Suture Forceps.....	62
ADSON Dura & Dissecting Hook.....	156
ADSON Dura Hook.....	156
ADSON Forceps.....	93
ADSON Needle Holder.....	121
ADSON Periosteal Elevator.....	402
ADSON Suction Tube.....	189
ADSON Tissue & Suture.....	54
ADSON Tissue and Suture Forceps.....	55
ADSON Tissue Forceps.....	62
AEBLI Corneal Scissors.....	41
AGRICOLA Lacrimal Sac Retractor.....	146, 355
ALEXANDER Chisel.....	394
ALLEN Intestinal Forceps.....	94
Alligator Forceps.....	321-323, 351
Alligator Forceps, Meisterhand.....	464
Alligator Forceps, Vantage.....	493
Alligator Scissors.....	46, 323
ALLIS Tissue Forceps.....	94, 334, 424
ALLPORT Mastoid Searcher.....	154
ALLPORT Retractor.....	147
ALM Retractor.....	147
Amalgam Carriers.....	229, 231
Amalgam Carriers, Vantage.....	495
Amalgam Condensers.....	230
Amalgam Pluggers.....	230, 231
Amalgam Wells.....	231
ANDREWS-PYNCHON Suction Tube.....	188
Anesthesia Instruments.....	182, 183
Aneurysm Needle.....	421
Angiotribe Hemostatic Forceps.....	96
ANTHONY Mastoid Suction Tube.....	189
ANTHONY Suction Tubes.....	188
Apical Dental Elevators.....	264
Applying Forceps for Micro Clips.....	347
Articodent.....	221
Articulating Paper.....	221
Aspirating Syringe.....	196, 258
AUFRIEHT Glabella Rasp.....	162
Aufricht Retractor Fiber Optic, Solid Blade.....	179
Autoclavable U Contra-Angle, 20,000 rpm.....	220
Automatic Dosing Syringe.....	197
Avian Oral Speculum.....	181
Awls.....	132
AYER Chalazion Forceps.....	370

B

Babcock Stainless Steel Suture Wire.....	133, 336, 384
Baby ALLEN Intestinal Clamp.....	94
Baby ALLIS Tissue Forceps.....	94
Baby BABCOCK Intestinal Forceps.....	94
Baby CRILE Forceps.....	86
Baby DOYEN Intestinal Forceps.....	94
Baby FARABEUF Retractor.....	140
Baby MIXTER Forceps.....	90
Baby MOLT Periosteal Elevator.....	257, 268
Baby OCHSNER Forceps.....	86
Baby PEAN Forceps.....	98
BABCOCK Intestinal Forceps.....	94
BACKHAUS Towel Clamp.....	101, 334, 424
BADGLEY Retractor.....	151
BAILEY-GIGLI Saw Guide.....	417
BAINBRIDGE Forceps.....	93
BAKES Common Duct Dilator.....	168

BALFOUR Abdominal Retractor.....	149
BALFOUR Center Blade.....	149
BALLENTINE Hysterectomy Forceps.....	88, 359
Bandage and Utility Scissors.....	49
Bandage and Utility Scissors, Meisterhand	441
Bandage Scissors, Vantage.....	490
BANE Rongeur.....	411
BARON Suction Tube.....	189
BARR double ended Probe.....	167
BARR Fistula Probe.....	355
BARRAQUER Cilia Suture Forceps.....	74
BARRAQUER Eye Speculum.....	145, 354, 372
BARRAQUER Needle Holder.....	126, 371
BARRAQUER Wire Eye Speculum.....	362, 372
BAUMBARTNER Needle Holder... 107, 116, 119	
Bayonet Dressing Forceps, Vantage.....	491
BEAUPRE Cilia Forceps.....	74
BECKMAN-WEITLANER Retractor.....	150
BEER Cilia Forceps.....	73, 370
BELLUCCI Alligator Scissors.....	46, 321, 323
BELLUCCI Micro Ear Scissors.....	321, 351
BENNETT Cilia Forceps.....	74, 370
BERGH Cilia Forceps.....	74
BEYER Rongeur.....	412
BIHRLE Needle Holder/Clamp.....	111
BILLEAU Flexible Ear Loop.....	324
BiopBlade.....	499
Biopsy Forceps, Meisterhand.....	485
Biopsy Punches, Disposable.....	498
BIRO Dermal Naevus Scissors.....	33
BISHOP-HARMON Forceps.....	70, 368
Blade Handle.....	501
Blade Remover.....	501
Blades.....	501
Blades for Finger Ring Cutter, Vantage.....	494
BLAKE Ear Forceps.....	75, 328
BLUMENTHAL Oral Surgery Rongeur.....	289, 411
BLUMENTHAL Rongeur.....	411
BOETTCHER Dissecting Scissors.....	25
BOLEY Gauge.....	223
Bone Chisels.....	283, 393, 394, 395
Bone Clamp.....	379
Bone Clamp, Meisterhand.....	463
Bone Curettes.....	269, 270, 405-407
Bone Cutting Forceps.....	288, 290, 336, 376,415, 416, 421
Bone Cutting Forceps, Meisterhand.....	463
Bone Cutting Forceps, Vantage.....	493
Bone Elevator.....	401, 402, 403
Bone File.. 163, 164, 281, 282, 398, 399, 400	
Bone Forceps, Meisterhand.....	463
Bone Forceps, Vantage.....	493
Bone Holding Clamp.....	380
Bone Holding Forceps 336, 376, 377, 378, 380	
Bone Holding Forceps, Meisterhand.....	463
Bone Reduction Forceps.....	380
Bone Saws.....	417, 418
Bone Wire Guide.....	132, 383
BONN Micro Suturing Forceps.....	69, 70, 348, 368
BONN Miniature Iris Scissors.....	38
BONNACOLTS Utility Forceps.....	73
BONNEY Tissue Forceps.....	64
BOTVIN Iris Forceps.....	69
Bovine Cervical Forceps.....	360
BOWMAN Lacrimal Probe.....	167
BOYNTON Needle Holder.....	119, 371
BOZEMAN Sponge Forceps.....	103, 358
BRACKEN Iris Forceps.....	68
BRIDGE Deep Surgery Forceps.....	89
BROPHY Scissors.....	39
BROWN Needle Holder.....	119
BROWN Tissue Forceps.....	64

BROWN-ADSON Forceps.....	55, 56, 62, 63,
--------------------------	-----------------

.....	257, 338, 424
BRUN Bone Curette.....	407
BRUNS Plaster & Cast Shears.....	51
Brushes.....	186, 318, 503, 510, 511
BUCK (SPENCER) Ear Probe.....	167
BUCK Ear Curette.....	324
BUCK Neurological Hammer.....	177
BUIE Fistula Probe.....	167
BUIE Suction Tube.....	189
Bulbous tip for Ear Syringe, Vantage.....	494
Bulldog Clamp.....	100
BUNNELL Bone Holding Forceps.....	380
BUNT Forceps Holder.....	524
Bur Blocks.....	219
Burnishers.....	201
Burs.....	210-218

C

Calcium Hydroxide Placer.....	227
Calipers.....	175
Canine & Feline Spay Kit.....	334, 424, 428
Canine & Feline Spay Kit, Meisterhand....	428
Canine Mouth Gag.....	181, 228
Canine Spay Kit, Vantage.....	494
Cannulas.....	185
CARB-N-SERT, See Tungsten Carbide	
Carbide Burs.....	210, 211, 212
Care and Cleaning Instructions.....	505
CARMALT Splinter Forceps.....	77
Cartilage & Tendon Instruments.....	408-410
Cartilage Scissors, Meisterhand.....	440
Carvers.....	202, 207
Carvers, Vantage.....	495
Cassette.....	515-523
Cast Scissors, Meisterhand.....	441
Cast Shears.....	48, 51
Cast Spreader, Vantage.....	493
CASTROVIEJO Caliper.....	175, 364
CASTROVIEJO Colibri Type Corneal Forceps.....	71
CASTROVIEJO Corneal Scissors.....	42, 44
CASTROVIEJO Corneal Section Scissors.....	44
CASTROVIEJO Corneoscleral Scissors.....	366
CASTROVIEJO Eye Speculum.....	144, 354
CASTROVIEJO Keratoplasty Scissors.....	44
CASTROVIEJO Micro Suturing Forceps.....	72
CASTROVIEJO Needle Holder.....	112, 125, 362
CASTROVIEJO Suturing Forceps.....	72
CASTROVIEJO Universal Corneal Scissors....	366
Cataract Knife.....	367
Cath Tray.....	532
Catheter Forceps, Vantage.....	491
Catheters.....	169
Cement Spatula, Vantage.....	495
Center Lock Stringer 2-1/2" wide.....	524
CERAM-A-GRIP Extracting Forceps, Vantage.....	495, 496
CERAM-A-GRIP Needle Holders.....	115, 116
Chalazion Forceps.....	370
CHANDLER Bone Elevator.....	403
CHARRIERE Bone Saw.....	418
Cheatle Forceps.....	527
Chisels.....	203, 283, 284, 327, 393, 394, 395
Chlorhexidine Juniors.....	306
CHRISTENSEN Teat Scissors.....	191
Cilia Forceps.....	73, 74, 370
Cleaning & Sterilizing Steps.....	505
Cleaning Brushes.....	186, 502, 511
Cleaning Brushes for Trachea Tubes... 186, 511	
Cleaning Products.....	508-510
CLEVELAND Oral Surgery Rongeur....	288, 289

Clip Applying Removing Forceps, Vantage.....	492
---	-----

Clips & Accessories 128
 CLODIUS Dissecting Scissors 27
 Closed U Stringer 2-1/2" wide 524
 COARSE Precision synthetic stone 512
 COBB Curette 405
 Collagen Products 294
 Collar Crown Scissors, Vantage 490
 College Pliers 292
 College Pliers, non-pinch 292
 College Pliers, Vantage 494
 COLLIER Forceps 87
 COLLIER Needle Holder 117
 COLLIN Tongue Seizing Forceps 183
 Color Bands 503, 513
 Combo Neuro Diagnostic Set 177
 Comedone Extractor, Vantage 494
 Composite Placement 204
 Condensers 230, 310
 Cone Socket Front Surface Mirror, 1 mirror 342
 Conical Arkansas Sharpening Stone, 1 stone 512
 Containers 526
 Contra Angles 220, 249
 CONVERSE (WILMER) Scissors 16
 CONVERSE Needle Holder 118
 COOK Eye Speculum 145, 355, 373
 COOLEY Needle Holder 109
 COOLEY Vascular Tissue Forceps 76
 CORN Suture Pliers 293
 Corneal Dissector 367
 Corneal Forceps 71, 368
 Corneal Knife 367
 Corneal Scissors 41, 42, 44, 366
 Corneal Scissors, Meisterhand 439
 Corneal Shield 364
 Corneal Utility Forceps 69, 368
 CORNELL Curette 191
 CORNELL Teat Curette 191
 CORWIN Wire Twister 131, 381
 COTTLE Double Hook 154
 COTTLE Rasp 162, 399
 COTTLE Retractor 139
 COTTLE Septum Elevator 401
 COTTLE Skin Elevator 401
 Cotton (College) Pliers 292
 COUPLAND Suction Tube 187
 Covault Hook, Vantage 494
 Covault Ovariohysterectomy Hook 425
 CRANE Pick Elevator 266
 CREGO Periosteal Elevator 403
 CRILE Forceps 86
 CRILE Forceps, Meisterhand 451
 CRILE Forceps, Vantage 491
 CRILE Needle Holder 121
 CRILE Retractor 139
 CRILE-WOOD (DeBakey) Needle Holder 109
 CRILE-WOOD Needle Holder 108, 116, 120
 CRILE-WOOD Quick-Release Needle Holder 114
 Crow Coagulating Forceps 56
 Crown Collar Scissors, Vantage 490
 Crown Gauge 223
 CRYER Elevator 265
 CryoSolutions 341
 CSR Wrap 525
 Curette, Sinus 286
 Curettes 240-246, 269, 270, 324, 325, 405-407
 Curettes, Meisterhand 478-479
 Curettes, Vantage 494
 Curved Endo Blocks 318
 CUSHING Forceps 65
 CUSHING Dura Hook 156
 CUSHING Vein Retractor 140
 Cuticle Scissors 45

D

DANDY Forceps 87
 DANDY Nerve Hook 156
 Danish Model Teat Knife 191
 Dappen Dishes 198, 226
 DAVIS Forceps 527
 DAVIS Foreign Body Spud 367
 DAVIS Retractor 147
 DAVIS Tissue Forceps 67
 DAY Ear Hook 153
 DEAN (BLUMENTHAL) Oral Surgery Rongeur 411
 DEAN Dissecting Scissors 26
 DEAYER Retractor 141
 DEAYER Retractor Fiber Optic, Delicate 179
 DEAYER Scissors 20
 DEBAKEY Needle Holder 109
 DEBAKEY Forceps 76
 DeBAKEY-ADSON Forceps 63
 DEBAKEY-POTTS Scissors 33
 Deep Slimline 7 519
 DENHARDT Mouth Gag 181, 228
 DenLite Charger Set 251
 DenLite Disposable Mirror, 110V, 3 boxes of 251
 DenLite Disposable Mirrors, single use 251
 DenLite Handle Set 251
 DenLite Handpiece Collet Assembly 251
 DenLite Illuminated Mirror 251
 DenLite Illuminator Tip 251
 DenLite Lamp for DP1000 251
 DenLite Lamp for DP1500 251
 DenLite LED Kit 251
 DenLite LED Light Cartridge 251
 DENNIS Anastomosis Clamp 94
 Dental Curettes 240-246
 Dental Elevators 261-266, 339
 Dental Extracting Forceps, Vantage 495, 496
 Dental Handpiece Prophylaxis Lube 220
 Depilatory Cream 502
 DERF Needle Holder 106, 117, 337, 344
 Dermal Curettes 499
 Dermal Punch 498
 Dermatology Spatula 208
 DESCHAMPS Ligature Carrier 132
 DESJARDIN Gall Stone Scoop 171
 DESMARRES Chalazion Forceps 370
 DESMARRES Corneal Dissector 367
 DESMARRES Lid Retractor 373
 DESMARRES Retractor 138
 DESMARRES-CHALAZION Forceps 362
 DeWECKER Iris Scissors 42

Diagnostics

Calipers 175
 Fiber Optic Instruments 179
 Gauges 175, 223
 Hammers 177
 Mallets 177, 396, 397
 Mouth Gag 181, 228
 Restraints 181, 228
 Retractors 137-151, 181, 228, 354, 355, 373, 385-387
 Ruler 175, 318
 Specula 180, 372, 373
 Tonometers 176, 363
 Tuning Forks 178

Diamond Burs 214-218
 Diamond Discs 219

Dilators

Catheters 169
 Dilators 168
 Director 166

Lacrimal Probe 167
 Probes 166-168, 355
 Scoops 171
 Sounds 170

Disposable Products

BiopBlade 499
 Biopsy Punch 485, 498
 Dermal Curettes 499
 Knife Handles 501
 Short Handled Biopsy Punch 498
 Sparta Products 502
 Standard and Safety Scalpels 500
 Surgical Blades 501

DIAMOND Pin & Wire Cutter 381
 DIEFFENBACH Serrefine 100
 DIETHRICH Micro Bulldog Clamp 100
 DINGMAN Bone Holding Clamp 380
 DINGMAN Small Bone & Cartilage Clamp 379
 Dissecting Scissors 14, 20, 21, 23-27
 Dissecting Scissors, Meisterhand 438
 Dissecting Scissors, Vantage 490
 Dissecting Tenaculum 421
 Dividers 223
 DIX Foreign Body Spud 367
 Dome Cath Cover, fits 3-937 & 3-938 532
 Dome Cath Cover, fits 3-937 & 3-938 532
 Dome Cath Cover, fits 3-941 532
 Dome Cath Cover, fits 3-943 532
 Dosing Syringe 197
 Double Action Parallel Pliers & Wire Cutter 131, 381
 Double Action Pin Cutter 382
 DOUBLE GRIT Precision synthetic stone 512
 DOUGLAS Cilia Forceps 74
 DOWNING Cartilage Knife 408
 DOYEN Abdominal Scissors 23
 Dressing Forceps 54, 55, 57, 60-76, 328, 331, 337, 348, 362, 368, 369
 Dressing Forceps, Meisterhand 443-447
 Dressing Forceps, Vantage 491
 DUBOIS Scissors 420
 Duckbill Ear Alligator Forceps 322
 DUKE Trocar and Cannula with 173
 DUPUYS-WEISS Ligature Carrier 132

E

Ear Curettes, Vantage 494
 Ear Forceps, Vantage 492

Ear Instruments

Alligator Ear Forceps 321, 322, 351
 Chisels 283, 284, 327, 393-395
 Dressing & Tissue Forceps 54-76
 Ear Curettes 325
 Ear Forceps 75, 321-323, 328, 351
 Ear Loops 324
 Hook 137, 139, 153-157, 327, 331, 334, 335, 360, 385, 424, 425
 Knives 233, 248, 319, 327, 361, 367
 Picks 267, 326

Ear Suction Tube 189
 Ear Syringes, Vantage 494
 ECHLIN Duckbill Rongeur 413
 EKG Caliper 175

Electrosurgical Instruments

Dressing & Tissue Forceps 331
 Schroeder-Braun Tenaculum Forceps 330
 Sterile Disposable Electrodes 332

Elevator, No. B1	286
Elevator, No. B2	286
Elevator, No. B3	286
Elevator, Sinus, Lift No. 1	286
Elevator, Sinus, Lift No. 2	286
Elevator, Sinus, Lift No. 3	286
Elevators 261-268, 286, 327, 339, 401-404	
Elevators, Meisterhand	484
ELSCHNIG Fixation Forceps	71
Emasculator	425
Emasculator	425
Emesis Basins	529, 531
EMMETT Tenaculum Hook	331
Endo block, aluminum	314
Endo Stand, 60 hole	523
Endo Stand, 72 hole	523
Endo-Klean Juniors	306
Endodilator Juniors	306
Endodontic Instruments	
Condensers	230, 310
Endo Block	314
Endodilator	306
Endodontic Forceps	313
Endodontic Spreaders	311
Endo-Klean	306
Gates Glidden Drills	297
Gutta Box	315
Gutta Percha	307
Juniors	306
Liberator Endodontic Files	296
Miltex Files	303-304
Miltex Reamers	305
Paper Points	307
Paste Carriers	309
Pluggers	230, 231, 310, 311
Root Canal Cabinets	316
Slide - File Lubrication	306
The Sprint TCM - Torque controlled electric endodontic motor	298
Tri-R Post System	308
Union Broach Barbed Broaches	304
Union Broach Files	299-302
Union Broach Reamers	305
Endodontic Pliers	293
Endodontic Pliers with lock	293
Enterotomy Scissors	33, 420
Enucleation Scissors	40
Enzyme Foam	508
ESMARCH Heavy Duty Bandage & Cast Shears	48
EVANS Pelvic Tissue Forceps	55
Excavators	199
Explorers	236, 237
Extension Cannula for Universal Handle	185
Extracting Forceps	257
Extracting Forceps	257, 271-279, 338
Extracting Forceps, Grip Deep 1 Standard	271
Extracting Forceps, Grip Deep 150	271
Extracting Forceps, Grip Deep 150A	271
Extracting Forceps, Grip Deep 151	271
Extracting Forceps, Grip Deep 210S	271
Extracting Forceps, Grip Deep 222	271
Extracting Forceps, Grip Deep 65	271
Extracting Forceps, Grip Deep 845	271
Extracting Forceps, Grip Deep 99C	271
Extracting Forceps, Grip Deep MD3	271
Extracting Forceps, Grip Deep MD4	271
Extracting Forceps, Petite	273
Extracting Forceps, Tungsten Carbide	279
Extracting Forceps, Vantage	495, 496
Extraction Instrument Kit	257, 338
Eye Dressing Forceps	57, 369

Eye Dressing Forceps, Vantage	492
Eye Forceps	369
Eye Kit	337, 362
Eye Scissors	30, 39
Eye Scissors with probe points	39
Eye Shield	364
Eye Speculum	144, 145, 337, 354, 355,362, 372, 373
Eye Suture (GRADLE) Scissors	44, 129
Eye Suture Scissors	44, 129
EZ-Zyme Cleaner	508

F

F Petite Tooth Extracting Forceps	273
Fahrenheit and Centigrade Scales	536
FARABEUF Retractor	140
FARABEUF-LAMBOTTE Bone Holding Forceps	377
FEASTER Wire Speculum	145
FEILCHENFELD Splinter Forceps	77
Feline Mouth Gag	181, 228
Feline Spay Kit, Vantage	494
Female Catheter	169
FERGUSON Angiotribe Hemostatic Forceps	96
FERGUSON Gall Stone Scoop	171
FERRIS-SMITH Tissue Forceps	76
Fetlock Clipper	194
FG Bur Removing-Inserting Tool	220
FG Bur Removing-Inserting Tool (Inserters)	220
FG Contra-Angle, Push-In Type, 20,000 rpm, autoclavable	220
FG to HP Converter (Friction Type)	220
FG to RA Adaptor Kit	220
FG to RA Adaptor only	220
Fiber Optic Cable, Autoclavable, with Olympus	179
Fiber Optic Instruments	179
Files	160-164, 247, 281, 282, 296,
FINE Precision synthetic stone	512
Finger Held Retractors	137
Finger Pluggers	311
Finger Ring Cutter Blades, Vantage	494
Finger Ring Cutter, Vantage	494
Finger Spreaders	312
Finishing Burs	213
FINOCHIETTO Needle Holder	123
FINOCHIETTO Thoracic Forceps	90
First Aid Shears, Vantage	490
Fixation Forceps	70, 71, 72, 368, 369
FLAGG Pliers	292
Flat Arkansas Sharpening Stone, 1 stone	512
Flat Cath Cover, fits 3-937 & 3-938	532
Flat Cover, fits 3-945 & 3-946	532
Flat Cover, fits 3-948	532
FLETCHER Sponge Forceps	103
Flexible Neck Rake Retractor	138
Flexible Stainless Ruler	175
Fluoride Coated Scissors	49
FOERSTER Eye Dressing Forceps	68
FOERSTER Sponge Forceps	357
FOMAN Rasp	160, 163, 376, 398
FOMON Dorsal Scissors	16
FOMON Lower Lateral Scissors	41
FOMON Periosteal Elevator	401
FOMON Saber-Back Scissors	16, 41
Foot Rot Shears	194

Forceps

Angiotribe Hemostatic Forceps	96
Bulldog	100
Clip Applying	128
Corneal Forceps .. 69, 70, 71, 81, 348, 368	
Dressing & Tissue Forceps	54-76

Dressing & Tissue Forceps,

Meisterhand	443, 444, 445, 446, 447
Fixation	70, 71, 72, 368, 369
Hemostatic Clamps	100
Hemostatic Forceps	83-99
Hysterectomy	88, 98, 359
Intestinal	94, 95, 97, 450
Jeweler	56, 80, 81, 337, 344, 349, 350
Microsurgical Forceps	80-81, 349-350
Mosquito	84, 85, 291, 313, 334,335, 348, 369, 424
Premium Dressing & Tissue Forceps	53-56
Splinter Forceps	77, 78, 79, 81, 291, 313
Sponge Forceps	102, 103, 357, 358,456, 492
Towel Clamps	101, 334, 335, 424, 428,456, 488, 493
Towel Clamps, Meisterhand	428, 456
Towel Clamps, Vantage	493
Towel Forceps	101, 456, 493

Foreign Body Needle	367
FOWLER Aluminum Mallet	397
FRANCIS Chalazion Forceps	370
FRANK Emasculator	425
FRAZIER Dura Hook	156
FRAZIER Suction Tube	187
FREER Elevator	268, 376, 401
FREER Skin Hook	154
French Catheter Scale	536
French Pattern Lacrimal Probe	167
FRIEDMAN Oral Surgery Rongeur	290
Front & Side Pin Wire Cutter	382

G

Gall Stone Scoop	171
GALLAHER Rasp	163, 398
GARDNER Oral Surgery Rongeur	290
GARLAND Hysterectomy Forceps	88
Gates Glidden Drills	297
Gauges	175, 223
GELPI Retractor	148, 470
GEMINI-MIXTER Hemostatic Forceps	95

General Dentistry Instruments

Amalgam Carriers	229, 231
Amalgam Pluggers & Condensers	230
Amalgam Wells	231
Applicators	200
Articulating Paper	221
Bur Blocks	219
Burnishers	201
Calcium Hydroxide Placer	227
Carbide Burs	210, 211, 212, 213
Carvers	202, 207
Chisels	203, 283, 284
Composite Placement	204
Dappen Dishes	226
Diamond Burs	214, 215, 216, 217, 218
Diamond Discs	219
Dividers	223
Excavators	199
Gauges	175, 223
Hatchets	205
Hoes	206
Lightning Strips	222
Low Speed Contra Angles	220
Messing Root Canal Gun	232
Mouth Gag	181, 228
Porcelain & Cement Carvers	207
Spatulas	208
Trimming & Finishing Burs	213
Wax	224, 225

General Surgery Kit

General Surgery Kit, Meisterhand428
 General Surgery Kit, Vantage494
 GERALD Forceps65
 GERZOG Mallet396
 GIGLI Saw.....417
 GIGLI Saw Handle.....417
 GIGLI-STRULLY Saw Handle417
 GIGLI-STRULLY Saw376
 GIGLI-STRULLY Saw Handle376
 GILL (Chandler) Iris Forceps69
 GILL Corneal Knife.....367
 GILL Iris Forceps.....69
 GILL-HESS Iris Forceps.....69
 GILLIES (CONVERSE) Skin Hook154
 GILLIES-SHEEHAN Needle Holder
 with Suture Scissors120
 GLABELLA Rasp161, 399
 GLOVER Patent Ductus Forceps97
 GOELET Retractor140
 GOLDMAN-FOX Wound
 Debridement Scissors.....31
 GOLDSTEIN Lacrimal Sac Retractor146, 355
 GOODHILL Ear Forceps.....323
 GORNEY Facelift Scissors, Saber-Back.....32
 Gorney Platysma Scissors12
 Gorney Rhytidectomy Scissors12
 Gorney Septal Morselizer.....410
 Gorney-Adson Forceps.....56
 Gorney-Freeman Scissors13
 GOSSET Retractor148
 Gracey Curettes.....240-245
 GRADLE Cilia Forceps.....74
 GRADLE Scissors11
 GRAEFE Eye Dressing Forceps.....69, 368
 GRAEFE Fixation Forceps.....70, 368
 GRAEFE Iris Forceps.....69, 368
 GRAHAM Nerve Hook.....156
 Grasping Forceps.....527
 GRAVES Vaginal Speculum180, 359
 GRAY Cystic Duct Forceps.....91
 GREEN Fixation Forceps.....71
 GREEN Needle Holder & Suturing Forceps.125
 GREVEN Ear Forceps323
 Grip Deep Extracting Forceps271, 272
 GripLite S6 #23 Explorer/
 18 mm Probe, double-ended....235, 342, 236
 GripLite S6 Barnhart 1/2
 Universal Curette235, 342, 246
 GripLite S6 Columbia 13/14
 Universal Curette235, 342, 246
 GripLite S6 J33/H5
 (Jacquette 33/1YS Scaler).....235, 342, 246
 GripLite S6 Mirror Handle,
 single-ended, cone-socket235, 342, 252
 GripLite S6 Morse 0-00 Scaler....235, 342, 238
 Grooming.....193-194
 GROSS Ear Hook & Spoon154
 GRUENWALD (JANSEN) Bayonet
 Dressing Forceps.....66
 Guenthers Embryotomy Knife360
 Gum Scissors31, 257, 338
 Gunter Lower Lateral Morselizer410
 GUTHRIE Fixation Hook153
 Guillotine Nail Scissors.....193
 Gutta Percha.....307
 Gynecological and
 Obstetrical Instruments.....357-360

H

Petite Tooth Extracting Forceps.....273
 HALSEY Needle Holder.....115, 117
 HALSTED Mosquito Forceps...84, 85, 291, 313, 424
 Hand Held Retractors.....138-143, 386, 387
 Handles, Knife501

Handpiece Lube 1/2 fl. oz bottle.....220
 HARMS Suturing Forceps72, 368
 HARRINGTON Scissors.....29
 HARTMAN LEE Mosquito Forceps85
 HARTMAN Mosquito Forceps.....85, 369
 HARTMAN Rongeur411
 HARTMAN-NOYES Alligator Ear Forceps....322
 Hatchets205
 HATT Spoon407
 HAYS Hand & Finger Retractor.....142, 385
 HEANEY Hysterectomy Forceps.....88
 HEANEY Needle Holder.....122
 HEANEY Tissue Forceps63
 HEANEY-BALLENTINE
 Hysterectomy Forceps.....88
 HEANY Needle Holder110
 HEATH Chalazion Forceps370
 HEATH Suture Scissors34, 129
 Heavy Utility Scissors.....320
 Hedstrom Files.....301, 302, 303
 HEGENBARTH Clip Applying Forceps128
 HEIDBRINK Root Tip Pick, delicate,
 double ended267
 HEIDBRINK Root Tip Pick, delicate, right...267
 HeliCote294
 HeliPlug294
 HeliTape294
 Hemostatic Forceps.....84-99
 Hemostatic Forceps, Miesterhand451-455
 Hemostatic Forceps, Vantage491, 492
 HERCULES Heavy Duty Bandage &
 Plaster Shears47
 HIBBS Chisel395
 HIBBS Gouge.....395
 HIBBS Osteotome390
 HIBBS Retractor139
 HIBBS SPRATT Spinal Fusion Curette406
 Hoes.....206
 HOFFMAN Alligator Ear Forceps.....322
 HOHMANN Retractor142
 HOKE Osteotome388
 Honing Oil.....512
 Hood Micro Stitch Scissors.....345
 Hoof Knife194
 Hoof Pick194
 Hoof Tester194
 Hoof Tester, Heavy Duty194

Hooks

Ear Hook153, 154, 474
 Nerve Hook.....156
 Skin Hook.....153, 154, 474, 475

Hooks, Meisterhand.....474-475
 Hooks, Vantage.....494
 HOUSE Alligator and Crimper Forceps323
 HOUSE Barbara Pick326
 HOUSE Curette.....325
 HOUSE Elevator327
 HOUSE Elevator & Chisel327
 HOUSE Forceps.....323
 HOUSE Hook327
 HOUSE Incudostapedial Joint Knife327
 HOUSE Lancet Knife.....327
 HOUSE Micro Strut Forceps321, 351
 HOUSE Forceps.....323
 HOUSE Myringotomy Knife327
 HOUSE Needle327
 HOUSE Obtuse Pick326
 HOUSE Oval Cup Forceps.....323
 HOUSE Oval Window Pick326
 HOUSE Sickle Knife327
 HOUSE Stapes Curette.....325
 HOUSE Strut Caliper326

HOUSE Strut Pick326
 HOUSE Tympanoplasty Knife327
 House-Bellucci Alligator Scissors.....46, 323
 HOUSE-DIETERS Malleus Nipper323
 HOUSE-Sheehy Knife Curette.....325
 HUDSON (EWALD) Dressing Forceps61
 HUDSON (EWALD) Tissue Forceps61
 HUGHES Hoof Groover194
 HUGHES Hoof Curette194
 HUGS Teat Knife, stainless steel.....191
 HUPP Hook155
 Hysterectomy Forceps.....98

I

IM Pins383
 Indicator Tapes525
 INGE Laminectomy spreader.....385
 Instrument Care Kit System.....510
 Instrument Care Training DVD.....511
 Instrument Cleaner508-510
 Instrument Guards.....514
 Instrument Lubricant509
 Instrument Prep Enzyme Foam508
 Instrument Sharpener513
 Instrument Stain Remover.....510
 Instrument Storage Trays with
 Silicone Mats514-515
 Instrument Sterilizing Tray523
 Instrument Stringers524
 Instrument Tray, Solid532
 Intestinal Forceps.....94, 95, 97, 450, 454
 Intestinal Forceps, Vantage492
 Iodine Cup530
 Iris Forceps, Vantage492
 Iris Operating Scissors.....39
 Iris Scissors....5, 38, 39, 42, 44, 337, 344-346
 Iris Scissors, Meisterhand431, 437,438
 Iris Scissors, Vantage490
 Iris Tissue Forceps59, 68, 69, 368, 369
 Iris Utility Scissors.....38
 ISRAEL Retractor142, 386

J

JACOBS Uterine Vulsellum Forceps.....96
 JACOBSON Hemostatic Forceps.....93
 JACOBSON Micro
 Mosquito Forceps84, 348, 369
 JACOBSON Microvascular
 Needle Holder352, 112
 Jaeger Lid Plate364
 JAMESON Caliper175
 JANSEN Ear Forceps75, 328
 JANSEN Retractor.....146
 JANSEN-WAGNER Retractor147
 Jeweler Style Forceps....80, 81, 337, 344, 349, 350
 JOHN HOPKINS Bulldog Clamp100
 JOHN HOPKINS Gall Bladder Forceps.....91
 JONES Forceps.....87
 JONES Towel Clamp101
 JORGENSON Scissors29
 JOSEPH Hook155
 JOSEPH Periosteal Elevator401
 JOSEPH Rasp162
 JULIAN Pattern Needle Holder110
 Juniors295, 306

K

K-Files.....303
 K-WIRE.....384
 KAHN Dissecting Scissors.....26
 KALT Needle Holder125
 KANTROWITZ Thoracic Forceps.....90
 KAYE Fine Dissecting Scissors25

KAYE Rhytidectomy & Dissecting Scissors	14
KAYE-Freeman Scissors	15
KELLY Forceps	86
Kelly Hemostat	424
KELLY Scissors	25
KELLY Sponge or Placenta Forceps	102, 357
KELLY Tissue Forceps	66
KERN Bone Holding Forceps	377
KERN Bone Holding Forceps, Large	376
KERN Bone Holding Forceps, Small	376
KERRISON Rongeur	414
KEY Periosteal Elevator	404
KILLIAN Septum Speculum	180
Killian Septum Speculum Fiber Optic	179
KIRBY Cornea-Scleral Forceps	68
KIRBY Fixation Forceps	369
KIRBY Iris Forceps	68
Kirschner Wires	384
Kits, Meisterhand	428

Kits, Surgical and Dental

Canine & Feline Spay Kit	334, 424, 428
Eye Kit	337, 362
General Surgery Kit	335, 428, 494
Luxating Dental Elevator Kit	260, 340
Microsurgical Instrument Kit	337, 344
Niemiec Veterinary Extraction Instrument Kit	257, 338
Orthopedic Kit	336, 376
Osteotome Kit	336, 376
Periotome Kit	259, 341
WELDIN Veterinary Periodontal Instrument Kit	235, 342
Winged Dental Elevator Kits	262, 339
Kits, Vantage	494
KLEINERT-KUTZ Rongeur	412
KLEINERT-KUTZ Synovectomy Rongeur	412
KLEINERT-KUTZ Tenotomy Scissors	41
KNAPP (ROLLET) Retractor	138
KNAPP Eye Speculum	144, 354
KNAPP Iris Scissors	38
KNAPP Retractor	138
Knives	248, 327, 367
KNOWLES Bandage Scissors	48
KOCHER Forceps	97
KOCHER Intestinal Forceps	97
KOGAN	330
KRATZ-BARRAQUER Wire Speculum	372
KREY Hook	360

L

LA GRANGE Scissors	31, 257, 338
Lacrimal Probe	167
LAHEY Forceps	87
LAHEY Gall Duct Forceps	91
LAMBERT-LOWMAN Bone Clamp	379
LAMBOTTE Osteotome	389
LANCASTER Eye Speculum	144, 354
LANE Bone Holding Forceps	378
LANGENBECK Metacarpal Saw	418
LANGENBECK Periosteal Elevator	402
LANGENBECK Retractor	141
Large Spoon, Peach	499
LARRY Probe & Grooved Director	166
Laschal Suture Cutter	34, 129
Laser Eye Shield	364
Laser Eye Shield Kit	364
LEKSELL Laminectomy Rongeur	413
LEMPERT Rongeur	414
LESTER Fixation Forceps	71
LEWIN Bone Holding Forceps	378
LEWIS Nasal Rasp	162
Liberator Endodontic Files	296

LICHTWICZ Antrum Trocar Needle	185
LICHTY Teat Knife	191
Lid Plate	364
Lid Retractor	373
Ligature Carrier	90, 132
Light Cable Adapter for Storz & Male ACMI	179
Lightning Strips	222
Lightweight Operating Scissors	19
LILLY Dissecting & Tonsil Scissors, Saber-Back	32
LINDES Embryotomy Knife	360
LISTER Bandage Scissors	47
LISTON Bone Cutting Forceps	416, 376, 421
LITTAUER Cilia Forceps	73
LITTAUER JR. Stitch Scissors	130
LITTAUER Stitch Scissors	35
LITTNER Suture Carrying Scissors	129
LOCKE Phalangeal Clamp	409
LONG Hysterectomy Forceps	88, 359
LONG Oral Surgery Stitch Scissors	130
LORNA Non-Perforating Towel Forceps	101
Loupes and LED Light System	179
LOVELACE Forceps	87
LOVELACE Gall Bladder Forceps	92
Low Speed Contra Angles	220
LOWE-BRECK Cartilage Knife	408
Lower Gall Duct Forceps	91
Lower Lateral Cartilage Morselizer	410
LOWMAN Bone Clamp	379
LOWMAN-HOGLUND Bone Clamp	379
Lubricant	509
LUCAE Ear Forceps	75, 328
LUCAE Mallet	396, 376
LUCAS Currettes	270
Luer Rongeur	411
LUER SYRINGE	258
Luxating Dental Elevator Kit	260, 340

M

M.G.H. Needle Holder	121
MAGILL Endotracheal Catheter	
Introducing Forceps	183
Magnetic Bur Block, autoclavable	219

Maintenance and Care Products

Cleaning Brushes	186, 511
Cleaning Products	508-510
Cleaning & Sterilizing Steps	505
Instrument Cassettes	515-523
Instrument Sharpeners	513
Instrument Stain Guide	507
Instrument Stringers	524
MILTEX Storage Container System	526
Sharpening Stones	512
Silitone Color Bands	513
Sterilization Products	514-528
Tip-It Instrument Guards	514

Mallets	177, 396, 397
Mallets, Meisterhand	481
MALTZ Nasal Rasp	162
MALTZ Rasp	162
MANHATTAN EYE & EAR Suturing Forceps	73
Marker for MICHELE Trepphine	417
MARTIN Cartilage Clamp	408
MARTIN Cartilage Scissors	33, 409
MARTIN Tissue Forceps	63
MARTINI Bone Curette	407
MATHIEU Needle Holder	107, 119
MATHIEU Retractor	139
Mats, see Cassettes	
MAUMENEÉ-PARK Eye Speculum	144
MAYO Common Duct Probe,	

malleable shaft	168
MAYO Common Duct Scoop	171
MAYO Dissecting Scissors	21
MAYO Dissecting Scissors, Vantage	490
MAYO Gall Stone Scoop	171
MAYO Operating Scissors	21
MAYO RUSSIAN tissue Forceps	66
MAYO Scissors	6, 7
Mayo Scissors, Meisterhand	429, 432
Mayo Scissors, Vantage	490
MAYO-HEGAR (MASSON) Needle Holder	108, 116, 120
MAYO-HEGAR Quick-Release Needle Holder	114
MAYO-NOBLE Dissecting Scissors	23
MAYO-ROBSON Intestinal Forceps	94
McCLURE Iris Scissors	42
McCREA Extra Small Urethral Sound	170
McCULLOUGH Suturing Forceps	73
McCULLOUGH Utility Forceps	73
McGANNON Retractor	138
MCGEE Crimper/Wire Closure Forceps	323
McGUIRE Corneal Scissors	41
MCKENTY Elevator	401
MCKENZIE Brain Clip Holding Rack	128
MCLEAN Whelping Forceps	360
MCPHERSON Micro Corneal Suturing Forceps	348, 70
McPHERSON Micro Iris Suturing Forceps	72, 337, 344, 350
McPHERSON Microsurgery Needle Holder	126, 371
McPHERSON Needle Holder	126
McPHERSON-VANNAS Micro Iris Scissors	44, 337, 344, 345
MCPHERSON-WESTCOTT Stitch Scissors	366
MEAD Extracting Forceps	275
MEAD Mallet	397
MEAD Rongeur	411
Meade Wire Cutting Pliers	381
Measurement Scale	537
Measuring Tape	175
Medicine Cup, Graduated	530
MEDIUM Precision synthetic stone	512

Meisterhand Instruments

Alligator Ear Forceps	464
Bandage & Cast Scissors	441
Biopsy Forceps	485
Bone Forceps	463
Currettes	478-479
Dressing & Tissue Forceps	443-447
Elevators	484
Hemostatic Forceps	451-455
Hooks	474-475
Instrument Kits	428
Iris and Strabismus Scissors	437-438
Mallets	481
Metzenbaum Scissors	433
Mouth Gags	473-474
Needle Holders	457-462
Operating Scissors	434
Osteotomes	482
Pin & Wire Instruments	442
Rasps	476
Retractors	465-472
Rongeurs	480
Saws	487
Scalpel Handles	486
Specula	473
Splinter Forceps	448
Stevens Scissors	439-440
Stitch Scissors	435-436
Suction Tubes	477

TC and SuperCut Iris Scissors431

TC and SuperCut Mayo
Dissecting Scissors.....429, 432
TC and SuperCut Metzenbaum Scissors.....430
Tissue Forceps449-450
Towel Clamps.....456

MELLER Lacrimal Sac Retractor.....146, 355
MELLINGER Eye Speculum.....145, 355, 373
Meniscus Retractor142
MERIAM Pliers292
Mesh Bur & Diamond Holders.....523, 528
METZENBAUM (Lahey) Scissors8, 22
METZENBAUM (Nelson) Scissors.....22
METZENBAUM Needle Holder.....121
METZENBAUM Scissors.....22, 10, 9, 19, 424
METZENBAUM Scissors.....22, 430, 433, 490
METZENBAUM Scissors, Vantage490
METZENBAUM, Meisterhand430, 433
MEYERDING Finger Retractor.....137
MEYERDING Retractor141
MEYERDING Skin Hook & Retractor...139, 153
MICHEL Clip Applying - Removing Forceps...128
MICHEL Wound Clips128
MICHELE Trephine.....417
Micro ADSON Forceps.....61, 348
Micro Alligator Ear Forceps351, 321
Micro BOLEY Gauge223
Micro Clip Approximator Set347
Micro FRIEDMAN Rongeur.....353, 414, 287

Microsurgical Instruments
Microsurgery Alligator Ear Forceps .. 321, 351
Microsurgery Forceps.....348, 349, 350
Microsurgery Retractors354, 355
Microsurgery Rongeurs353
Microsurgery Scissors 42, 43, 44, 345, 346
Microsurgical Instrument Kit337, 344
Microsurgical Needle Holders 124, 125, 126

MICULICZ Peritoneal Forceps.....97
MILLARD Thimble Hook Retractor.....137
MILLER Curette270
MILTEX 3-Prong Cast Spreader51
MILTEX Artery & Undermining Forceps.....89
MILTEX Ball Bearing Deluxe U Contra-Angle.....220
MILTEX Blepharoplasty Scissors.....16
MILTEX Cannulated Pin & Wire Cutter.....381
MILTEX Cross Action Retractor.....147
MILTEX Depilatory Forceps76
MILTEX Ear Forceps.....323
MILTEX Edge Scissors Sharpener.....513
MILTEX Fiberglass Tape Measure.....175
MILTEX First Aid and Utility Shears.....49
MILTEX Instrument Care DVD.....511
MILTEX Instrument Care Training.....510
MILTEX Nurse's Bandage Scissors.....49
MILTEX Pin & Wire Gauge175, 383
MILTEX Pin Cutter382
MILTEX Rhytidectomy Scissors, Saber-Back..32
MILTEX Skin Hook154
MILTEX Splinter Liberator78
MILTEX Tendon Pulling Forceps409
MILTEX Tissue Twist Hook.....155
MILTEX Tuning Forks178
MILTEX Wire Cutting Scissors.....37
MILTEX Luxators.....340
MILTEX Storage Cassettes515
MILTEX Disposable Ear Curette.....324, 499
MILTEX Grooving Director166
MILTEX Luxating Elevator257, 338
MILTEX POOLE Suction Tube187
MILTEX Probe166, 337, 344

MILTEX Skin Staple Removing Forceps128
MILTEX Winged Dental Elevator.....339
Mini Osteotome392
MINI-HOHMANN Retractor142, 386
Miniature Blade Handle501
Mirror Handles.....252
Mirrors251, 252, 253, 254, 255
Mixing Slabs226
MIXTER Forceps.....89
MIXTER Forceps LEE Modified.....90
MIXTER Irrigating Dilating Probe168
MIXTER Scissors.....20
MIXTER Thoracic Forceps.....89
Moleskin & Felt Scissors.....33
MOLT 2-4 Curette270
MOLT 9 Periosteal Elevator268
MOLT Mouth Gag181, 228
MOSQUITO Forceps84, 85
Mosquito Hemostatic Forceps, Vantage491
Mouth Gags181, 228
MOYNIHAN Gall Duct Forceps.....91
MURDOCK Eye Speculum.....145, 354, 373
MUSEUX Uterine Vulsellum Forceps96
Mx Esonic Scaler.....250

N

Nail and Hoof, Grooming

Cat Claw Scissors194
Foot Rot Shears194
Small Animal Toenail Nipper45, 193

Nail Scissors.....45, 46
Nail Scissors, Vantage490
Nasal Scissors46
Nasostat502

Needle Holders

CARB-N-SERT Needle Holders.....106-114
CERAM-A-GRIP Needle Holders115, 116
Microsurgical Needle Holders.....124-126
Needle Holders, Meisterhand456

Needle Holders, Meisterhand.....457-462
Needle Holders, Vantage493
Needles134, 135
NEIVERT Needle Holder113, 118
Neoprene Cord for 32" Tourniquet.....228
NESTED Trocar, Set of 4.....173
Neuter & Emasculation Instruments.....425
NEW ORLEANS Needle Holder.....109, 121
NEW'S Suture Scissors.....34, 129
NEWS Hook.....155
NIEMIEC Veterinary Extraction
Instrument Kit.....257, 338
NORTHBENT Stitch Scissors.....35, 130
NOYES Alligator Forceps322, 464
NOYES (ROSS) Iris Scissors.....42
NOYES Iris Scissors.....42
NUGENT Utility Forceps.....72
Nurse's Bandage Scissors49
Nylon Cap Replacement396, 397

O

O'BRIEN Fixation Forceps.....71
O'CONNOR Iris Forceps68
O'BRIEN Stitch Scissors130
Obstetrical Caesarean Forceps360
Obstetrical Forceps360
Obstetrical Instruments.....359
OBWEGESER Mandibular Awl for
Wire Suturing132
Occluding Forceps, Vantage492
OCHSENBEIN Chisel Tactile Tone

double end283
OCHSNER Trocar, Philadelphia pattern173
OHL Periosteal Elevator.....268
Oil512
OLSEN-HEGAR Needle Holder...107, 115, 118,
.....257, 338, 352, 424, 428
Open U Stringer 2-1/2" wide.....524
Operating Scissors1, 4, 18, 19, 21, 23,
.....39, 257, 338, 426, 434, 490
Operating Scissors, Meisterhand434
Operating Scissors, Vantage.....490

Ophthalmic Instruments

Knives367
Laser Eye Shield.....364
Ophthalmic Forceps368-370
Ophthalmic Needle Holders371
Ophthalmic Scissors365, 366
Ophthalmic Specula.....372, 373
Tonometers363
Veterinary Eye Kit337, 362

Oral Surgery Instruments

Apical Dental Elevators.....264
Bone Chisels.....283, 284
Bone Curettes269, 270
Bone Files.....281, 282
College Pliers.....292
CORN Suture Pliers293
Extracting Forceps.....277-280
Extracting Forceps, Petite273
Extracting Forceps,
Tungsten Carbide279, 280
Grip Deep Extracting Forceps.....271, 272
Local Anesthesia.....258
Luxating Dental Elevators.....260, 261
Miltex Niemic Veterinary
Extraction Instrument Kit.....257, 338
Osteotome.....285
Periosteal Elevators.....268
Periotome Kit259
Pig Tooth Nippers290
Rongeurs.....287-290
Root Tip Elevators & Picks267
Root Tip Forceps291
Sinus Lift Instruments.....286
Winged Dental Elevators262, 263, 339
Wound Dressing Products294

Orthopedic Instruments

Bone Curettes405-407
Bone Cutting Forceps.....415, 416
Bone Files.....398-400
Bone Holding Clamps377-380
Bone Holding Forceps377, 378, 380
Bone Saws.....417, 418
Cartilage & Tendon Instruments . 408, 409, 410
Chisels.....393-395
Elevators.....401-404
Gouges393-395
Mallets396, 397
Orthopedic Kit376
Osteotomes.....388-392
Periosteals401-404
Pin & Wire Instruments381-384
Rasps.....398-400
Retractors.....385-387
Rongeurs.....411-414

Oral Surgery Rongeur289
Ortho Cassette.....522
Osteotome Kit336, 376
Osteotome285, 388-390, 392
Osteotomes, Meisterhand.....482

OSTERTAGS Blunt Eye Hook.....360

P

PACKER Mosquito Forceps84
 Packs333
 Padgett-RUBIN Morselizer.....410
 PANTZER Hi-Level Bandage Scissors48
 PAPARELLA-WEITLANER Retractor.....150
 Paper Points.....307
 PAR Dissecting & Tissue Scissors.....16
 PAR Needle Holder.....106
 PARKER Retractor140
 PARKES Rasp160
 PARKHOUSE Needle Holder/Scissors113
 PATTERSON Trocar.....173
 PATTON Needle Holder126
 PEAN Hysterectomy Forceps98, 359
 PEDERSON Vaginal Speculum180
 PEET (COTTLE) Rasp161, 399
 PEET Splinter Forceps.....78, 291, 313
 Pencil-Type Micro Surgery Scissors.....346
 PENNINGTON Tissue Grasping Forceps.....92
 Periodontal Instrument Kit235, 342
 Periosteal Elevators268, 402, 403, 404
 Periostomes259, 335
 Periostome Kit.....259, 335
 Petite Aspirating Syringe.....196, 258
 Petite BALFOUR Abdominal Retractor.....149
 Petite GELPI Retractor148
 Petite GOSSET Retractor148
 Petite Mouth Gag181,228
 Petite Tooth Extracting Forceps.....273
 PHANEUF Uterine Artery Forceps88
 Physicians' Splinter Forceps.....78
 Picks267
 PIERCE Double End Elevator.....401
 PIERSE Colibri Type Corneal Forceps71
 Pig Tooth Nippers.....290
 Pin & Wire Instrumentation131, 382
 Pin and Wire, Meisterhand.....442
 Pin Cutter376
 Pinwheel, Vantage494
 Plain Emasculator.....425
 Plain Splinter Forceps.....77
 Plain Wire Eye Speculum....144, 372, 337, 344
 Plaster Shears.....51
 Plaster Shears, Vantage490
 Plastic Bur Block.....219
 Plastic Surgery Scissors.....11, 28
 Pliers, Vantage494, 495
 Pluggers230, 231, 310, 311
 POLOKOFF Bone File164, 282, 400
 Posigrp Articulating Paper Forceps221

Post Mortem Instruments

Post Mortem Hammer.....421
 VIRCHOW Brain Sectioning Knife420
 POTTS Elevator266
 POTTS-SMITH Forceps.....55,64
 POTTS-SMITH Scissors24
 PRATT Rectal Probe.....167, 355
 PRATT T-Shape Forceps.....87
 Premium Rasps, Tungsten Carbide159-161
 PRICHARD Periosteal Elevator.....268
 PRINCE Trachoma Forceps370
 Probes167, 337, 344, 355

Prophylaxis Instruments

DenLite Illuminated Mirror251
 Esonic Scaler250
 Explorers236, 237
 Files247
 Gracey Curettes240-245

Gracey Curettes - Rigid Shank241
 Gracey Curettes - Root Plane... 242, 243, 245
 Gracey Curettes -Root Plane Petite244
 Gracey Curettes -
 Root Plane Petite Rigid Shank245
 Gracey Curettes -
 Root Plane Rigid Shank.....243
 Knives248
 Miltex WELDIN Veterinary
 Periodontal Instrument Kit.....235, 342
 Mirrors252, 253, 254, 255
 Probes.....236, 237, 355
 Prophylaxis Angles249
 Scalers.....238, 239
 Universal Curettes246

PROVIDENCE HOSPITAL Forceps.....86
 Pumice249
 Punches, Disposable498
 PUTTI Bone Rasp.....163, 398

Q

Quick-Lock Tourniquet.....181, 228
 Quick-Release Needle Holder114

R

RA Matrix Scissors.....36
 RAGNELL Dissecting Scissors.....26
 RANKIN Forceps87
 Rasps160-164, 398-400
 Rasps, Meisterhand.....476
 Rats Tooth, See Forceps
 Reamers.....297,305
 Red Rubber Bulb 211A no Valve.....209
 Redundant Wall Retractor330
 REEH Stitch Scissors36
 REES Bayonet Forceps56

Reference Guides

Autoclaving.....537
 Dental Instrument Hand
 Sharpening Instructions.....540-541
 Fahrenheit and Centigrade Scales.....536
 French Catheter Scale.....536
 Instrument Service, Repair and
 Return Instructions544
 Instrument Warranty542
 Measurement Scale.....537
 Needle Holder/Suture Guide534
 Storage Cassette Autoclave and
 Ultrasonic Compatibility Chart538
 Terms and Conditions544

REIMER Emasculator425
 Replacement Slip On Clip.....410
 Restraints.....181, 228

Retractors

Finger Held Retractors.....137
 Hand Held Retractors . 138, 139, 140, 141,
142, 143, 386, 387
 Self-Retaining Retractors.....144, 145, 146,
147, 148, 149, 150, 151
 Specula144

Retractors, Meisterhand465-472
 Retractors, Vantage.....494
 REYNOLDS Dissecting Scissors24
 RHOTON Micro Forceps67, 350
 Rib Shears.....50, 421
 Ribbon Retractor.....140
 RICH Corneal Transplant Scissors366
 RICHARDSON Retractor141

RICHTER Dissecting Scissors27, 420
 RICHTER-HEATH Clip Removing Forceps128
 RIGBY Appendectomy Retractor.....148
 Rigid Neck Rake Retractor.....138
 Ring Cutter.....45, 487, 494
 Ring Cutter, replacement blade45
 Ring Handle Forceps, see Hemostats
 ROCHESTER-CARMALT Forceps.....99
 ROCHESTER-OCHSNER Forceps.....99, 424
 ROCHESTER-PEAN Forceps.....98
 ROEDER Clamp.....379
 ROEDER Towel Clamp.....101
 Rongeurs287-290, 353, 411-414
 Rongeurs, Meisterhand480
 Root Canal Cabinets316
 Root Canal Gun232
 Root Tip Elevators & Picks.....267
 Root Tip Forceps.....291
 ROSEN Knife Curette325
 ROSEN Pick.....326
 ROSENBLUM Sesamoidectomy Clamp....409
 ROSSER Crypt Hook.....157
 ROUX Automatic Revolver Syringe.....197
 ROUX Retractor140
 Rubber Dam Punch355
 Rubber jaw replacements for YOUNG
 Tongue Forceps183
 RUGGEBERGS obstetrical
 double eye hook.....360
 Rulers175
 RUMEL Thoracic Forceps.....95
 RUSKIN Antrum Trocar Needle.....185
 RUSKIN Bone Cutting Forceps415
 RUSKIN Rongeur.....412
 RUSSIAN Tissue Forceps.....64
 RYDER -Type Intracardiac Needle Holder...109
 RYDER Needle Holder111

S

SAROT Intra-Thoracic Artery Forceps.....96
 SAROT Needle Holder.....110, 122
 SATTERLEE Bone Saw418
 SAUER Eye Speculum145, 354, 373
 Saws417, 418
 Saws, Meisterhand487
 SAWTELL Tonsil Hemostatic Forceps.....92
 SAYRE Periosteal Elevator402
 Scalers238, 239-245
 Scalpel Handle, Meisterhand.....486
 Scalpel Handles.....501
 Scalpels500
 SCHAAF Foreign Forceps.....73
 SCHINK Metatarsal Spreader151
 SCHIOTZ Tonometers363
 SCHNIDT Tonsil Hemostatic Forceps.....92
 SCHROEDER-BRAUN Tenaculum Forceps ...330

Scissors

Premium Scissors, Tungsten Carbide &
 SuperCut2-17
 Alligator & Nasal Scissors46, 323
 Bandage & Utility Scissors47, 48, 49
 Cast Instruments51
 Dissecting Scissors.. 14, 20, 21, 23-27, 420
 Eye Scissors30, 39
 Fluoride Coated Scissors.....49
 General Surgery Scissors 29, 30, 31, 32, 33
 GORNEY Scissors.....12
 Iris Scissors5, 11, 38, 39, 42, 44,
337, 344-346
 Iris Scissors, Meisterhand437, 438
 Kaye Scissors14
 MAYO Scissors.....6, 7

Metzenbaum Scissors . 8-10, 334, 335, 424
 Microsurgery Scissors 42-44, 345, 346
 Operating Scissors..... 4, 18-21, 23-27,
257, 338
 Plastic Surgery Scissors 11, 28
 Rib Shears 50, 421
 Specialty Scissors..... 11, 16, 17, 45, 320
 Specialty Scissors &
 Cutting Instruments 1, 45
 Suture Scissors..... 34, 44, 129
 Suture Scissors, Meisterhand436,440
 STEVENS Scissors, Meisterhand439
 Stitch and Wire Scissors130
 Stitch Scissors, Meisterhand435-436
 Strabismus Scissors, Meisterhand ...431,438
 Tenotomy Scissors..... 5, 30, 41, 43, 337,
362, 365
 Tenotomy Scissors, Meisterhand439

Scoops..... 171
 SCOVILLE Clip Applying Forceps.....128
 SCUDDER Intestinal Forceps.....95
 SEDILLOT Periosteal Elevator.....401
 SEILER Turbinate Scissors.....41
 SELDIN Periosteal Elevator268, 404
 Self-Retaining Retractors 144-151
 SEMKEN Forceps.....60
 SENN Retractor.....139, 376
 Serrate Operating Scissors.....19
 Serratex-MAYO Dissecting Scissors.....21
 Serrefine Clamp 100
 Service, Repair and Return Instructions544
 SHALLCROSS Cystic Duct Forceps.....91
 Sharpening Stones..... 512
 Shears, First Aid, Vantage.....490
 Shield for Ear Syringe, Vantage494
 Short Handled Biopsy Punch.....498
 SHORTBENT Stitch Scissors.....35, 130, 365
 Side Lock Stringer.....524
 Silicone Mats 515
 Silitone Color Bands..... 513
 Silver Point Holding Forceps291, 313
 SIMS Scissors29
 SINGLEY Tissue Forceps67
 SISTRUNK Operating Scissors.....23
 SKILLERN Sinus Probe167
 Skin Hooks.....153
 Slide Juniors.....306
 Slimline Casette.....519
 Small Animal Toenail Nipper.....45, 193
 Small WHITE Emasculator425
 SMILLIE Meniscus Hook Retractor142, 385
 SMILLIE Meniscus Knife.....408
 SMITH Corneal Shield364
 SMITH Eye Speculum354
 SMITH-PETERSON Gouge395
 SMITH-PETERSON Osteotome389
 SMITHWICK Nerve Hook156
 Snook Hook, Vantage494
 Snook Ovariohysterectomy Hook.....425
 Sonic Scaler.....250
 Sounds 170
 Spare Suction Handle364
 Sparta Products502
 Spatulas..... 208
 Spatulas, Vantage495
 Spay Kit 334, 424
 Spay Kit, Meisterhand.....428
 Spay Kits, Vantage494

**Spay, Neuter and
 Castration Instruments**
 Canine & Feline Spay Kit 334, 424
 Neuter & Emasculation Instruments 425

Specula.....144, 145, 180, 372, 373
 Specula, Meisterhand473
 SPENCER Stitch Scissors35, 130, 365
 Spiral Rack for Surgical Needles133, 528
 Splinter Forceps 77-79, 291, 313
 Splinter Forceps, Meisterhand448
 Splinter Forceps, Vantage.....491
 Splinter Liberators, Vantage491
 Splinter Removal Kit, Vantage491
 Sponge Forceps..... 52, 102, 103, 356-358,
456, 492
 Sponge Forceps, Meisterhand456
 Sponge Forceps, Vantage.....492
 SPRATT (Brun) Curette.....406
 Spratt Bone Curette376
 SPRATT Curette405
 Spray Lube 509, 510
 Spring Bow Divider.....223
 Spring Wire Retractor.....147
 Sprint TCM and Tardie 10.....298
 Stain Remover 510

Stainless Steelware Products

Emesis Basins..... 531
 Instrument Trays & Covers 532
 Sponge Bowls 530

Stainless Steelware..... 530, 531, 532
 Stainless Wire Brush511
 Steam Indicator Strips..... 525
 Steimann Pins383
 Sterilization and Storage Container System 526
 Sterilizer Forceps, Vantage491
 STEVENS Iris Forceps.....68
 STEVENS Tenotomy Scissors30, 362, 5, 365
 STEVENSON Lacrimal Sac Retractor146
 STILLE Pattern Rib Shears.....50, 421
 STILLE Pattern Tissue Forceps61
 STILLE Plaster & Cast Shears51
 STILLE-Giertz Rib Shears.....50
 STILLE-HORSLEY Bone Cutting Forceps416
 STILLE-LUER Rongeur.....413
 Stitch Scissors..... 35, 36, 43, 130, 345, 365, 366
 Stitch Scissors, Meisterhand436
 Stitch Scissors, Vantage.....490
 STONE Tissue Forceps.....63
 Strabismus Scissors 11, 30, 39, 365
 Strabismus Scissors, Meisterhand431, 438
 Strabismus Scissors, Vantage490
 Strabismus Tissue Forceps70
 Straight Endo Blocks318
 STRATTE Needle Holder110, 122
 Stringers 524
 Strip Holding Forceps222
 STRUEMPEL Alligator Ear Forceps.....322
 STRULLY Dissecting Scissors25

Suction and Aspiration Instruments

Cannulas and Needles.....185
 Suction Tubes.....187, 188, 189
 Tracheal Tubes.....186

Suction Tubes, Meisterhand477
 SuperCut Scissors..... 4-6, 8-16
 Supercut Scissors, Meisterhand 429-431
 Surgery Kits, Vantage.....494
 Surgi-Brush, Sterile502
 Surgi-Clamp, Plastic.....502
 Surgi-Prep Depilatory.....502
 Surgical Instrument Cleaner..... 508-510

Suturing

Awls132

Clips & Accessories..... 128
 Guides 132
 Ligature Carriers..... 132
 Pin & Wire Instrumentation 131
 Stitch Scissors... 35, 36, 43, 130, 345, 365, 366
 Surgical Needles..... 134, 135
 Suture Scissors..... 34, 44, 129
 Suture Wire 133, 336, 376, 384

Suture/Wire Cutting Scissors.....16, 35-37, 131
 Swedish Model Curette.....191
 Swedish Needle Holder.....113
 SWISS Cilia and Suture Forceps.....74, 370
 SWISS Jeweler Style Forceps...80, 81, 349, 350
 Swiss Pattern Osteotomes.....376, 388

Syringes

Aspirating..... 196, 258
 Automatic Dosing Syringe..... 197
 Local Anesthesia 196, 258

Syringe, Water209

T

Tape Measure 175
 Tardie Complete System
 (Airmotor, adapter and angle)298
 Tartar Removal Forceps280
 Tartar Scraper, Vantage495
 TAYLOR Dural Scissors (ideal for feline)48
 TAYLOR Percussion Hammer177
 Teat Instruments 191
 Temporal Approach Wire Speculum ..145, 372
 Tenotomy Scissors 5, 30, 41, 43, 337, 362, 365
 Tenotomy Scissors, Meisterhand439
 Tenotomy Scissors, Vantage.....490
 Terms and Conditions544
 Test sticks - Black512
 THEOBALD (FISH) Sinus Probe167
 Thompson516-518
 THOREK Scissors29
 THORPE Caliper.....175
 THORPE Corneal and Splinter Forceps.....81
 Three Prong Forceps527
 TIECK-HALLE Infant Speculum359
 Tip for ANDREWS-PYNCHON188
 Tip for Ear Syringe, Vantage494
 Tip for YANKAUER Suction Tube.....188
 Tip-It Instrument Guards..... 514
 Tissue & Cuticle Nipper193
 Tissue Forceps..... 54-76, 257, 331, 334,
338, 348, 368, 369, 424
 Tissue Forceps, Meisterhand428, 443-450,
491, 492
 Tissue Forceps, Vantage491, 492
 Tissue Twist Hook 155
 Tongue Seizing Forceps 183
 Tonometers 176, 363
 TOOKE Corneal Knife..... 367
 Towel Clamp 101
 Towel Clamp/Forceps, Vantage493
 Towel Clamps, Meisterhand456
 Tracheal Tubes 186
 Trays & Covers..... 532
 Trephine 417
 Trocars..... 173
 TROUTMAN-BARRAQUER Colibri368
 TROUTMAN-BARRAQUER Colibri Type
 Corneal Utility Forceps.....69, 368
 Tube Occluding Forceps, Vantage.....492
 TUFFIER Retractor151
 Tungsten Carbide Instruments
 Tungsten Carbide Needle Holders..... 106-114
 Tungsten Carbide Forceps.....54-56

Tungsten Carbide Rasps 160, 161
 Tungsten Carbide Scissors 4-17
 Tuning Forks 178
 TYRELL Hook 153

U

U Contra-Angle, 20,000 rpm, autoclavable 220
 U-63 Box 317, 318
 UDALL BISTOURI Teat 191
 U.S. ARMY Pattern Chisel 394
 U.S. ARMY Pattern Gouge 394
 U.S. ARMY Pattern Osteotome 388
 U.S. ARMY Retractor 140
 U.S.A. Gauze Scissors 48
 Union Broach Files 48, 299
 Universal Scissors 49
 Universal Scissors, Vantage 490
 University of Oregon Fixott-Everett Grid,
 Small Anterior 227
 Urethral Sound 170
 Utility Forceps 527, 528
 Utility Scissors 43, 45, 49, 320

V

Vaginal Speculum 180, 359
 VAN BUREN Catheter Guide 169
 VAN BUREN Urethral Sound 170
 VANNAS Capsulotomy Scissors 41

Vantage Instruments

Dental Instruments 495-496
 Forceps 491-493
 Kits 494
 Needle Holders 493
 Retractors, Curettes, Dermal 494
 Scissors 490
 Towel Clamps 493

VANTAGE Articulating Paper Forceps 221
 VANTAGE Economy PROPHY Angle 249
 VERBRUGGE Bone Forceps 380
 Vessel Clips 347
 Video, Instrument Care 511
 VIENNA Nasal Speculum 180
 VIRCHOW Brain Sectioning Knife 420
 VIRCHOW Skull Breaker 421
 VIRTUS Splinter Forceps 78
 VOLKMAN Double Ended Curette 407
 VOLKMAN Finger Retractor 137
 VOLKMAN Hook 157
 VOLKMAN Hook Retractor 157, 385
 VOLKMAN Retractor 143, 387
 VON GRAEFE Strabismus Hook 153

W

WACHENFELD Applying - Removing Forceps 128
 WALDEAU Fixation Forceps 70
 WALTER Splinter Forceps 77
 WALTHER Female Dilator-Catheter 169
 WALTON Foreign Body Gouge 367
 WANGENSTEEN Needle Holder 111, 123
 Warranty 542
 Wax 224, 225
 Wax Carver, Vantage 495
 Wax Spatula 208, 404
 Wax Spatula, Vantage 495
 WEBSTER Needle Holder 106, 115, 117
 WEBSTER Quick-Release Needle Holder 114
 WEINGARTNER Alligator Ear Forceps 322
 WEITLANER Retractor 150, 376
 WERTHEIM-CULLEN Pedicle Clamp 89
 WERTHIEM Pedicle Clamp 89

WESTCOTT Stitch Scissors 43, 130
 WESTCOTT Tenotomy Scissors 43
 WESTCOTT Utility Scissors 43
 White Dog Nail Scissors, Vantage 490
 WHITE Improved Emasculator 425
 WHITE Toenail Scissors 45, 193
 WIENER Corneal Hook 153
 WILDE Forceps 75, 328
 WILLIAM HOUSE Suction-Irrigation Tube 187
 WILLIAMS Eye Speculum 144, 354
 WILLIAMS Splinter Forceps 78, 291, 313
 WILLIGER Bone Curette 407
 WILLS HOSPITAL Utility Forceps 73
 WILMER (Converse) Conjunctival and
 Utility Scissors 30
 Winged Dental Elevator Kits 262, 339
 WINTER Placenta Forceps 359
 Wire Brush 511
 Wire Cutting Pliers 381
 Wire Cutter 376
 Wire Cutting Scissors, Meisterhand 442
 Wire Cutting Scissors, Vantage 490
 Wire Saws 417
 Wire Twister 110, 131, 376, 381
 Wire, Kirshner 384
 Wire, Suture 384
 WITZEL Root Splinter Forceps 278
 Work-Utility Box 317
 Wound Dressing Products 256, 294
 YANKAUER Suction Tube 188
 YOUNG Tongue Seizing Forceps 183

Z

Z-Type Scissors 17
 ZAUFEL-JANSEN Rongeur 412
 ZIEGLER Cilia Forceps 73

011-24500	253	012-10075	300	012-11186	301	012-12403	308
011-24501	253	012-10076	300	012-11187	301	012-12404	308
011-24502	252	012-10076	300	012-11188	301	012-12501	308
011-24503	252	012-10077	300	012-11189	301	012-12502	308
011-24504	253	012-10078	300	012-11190	301	012-12503	308
011-24505	253	012-10079	300	012-11191	301	012-12504	308
011-24506	252	012-10180	300	012-11192	301	012-13001	304
011-24507	252	012-10181	300	012-11193	301	012-13002	304
011-24508	253	012-10182	300	012-11194	301	012-13003	304
011-24509	252	012-10183	300	012-11195	301	012-13004	304
011-24510	253	012-10184	300	012-11196	301	012-13005	304
011-24511	252	012-10185	300	012-11197	301	012-13006	304
011-24512	253	012-10186	300	012-11198	301	012-13007	304
011-24513	252	012-10187	300	012-11199	301	012-13008	304
011-24514	253	012-10188	300	012-11200	301	012-14002	299
011-24515	252	012-10189	300	012-11201	301	012-14003	299
011-24673	252	012-10190	300	012-11202	301	012-14004	299
011-24674	252	012-10191	300	012-12002	305	012-14005	299
011-24677	252	012-10192	300	012-12003	305	012-14006	299
011-24678	252	012-10193	300	012-12004	305	012-14007	299
011-24679	252	012-10194	300	012-12005	305	012-14008	299
011-24680	252	012-10195	300	012-12006	305	012-14009	299
011-24692	252	012-10196	300	012-12007	305	012-14010	299
011-24693	252	012-10197	300	012-12008	305	012-14011	299
011-24694	252	012-10198	300	012-12009	305	012-14012	299
011-24695	252	012-10199	300	012-12010	305	012-14013	299
011-24700	252	012-10201	300	012-12011	305	012-14014	299
011-24701	252	012-10202	300	012-12012	305	012-14015	299
011-24702	252	012-10203	300	012-12013	305	012-14016	299
011-24703	252	012-10204	300	012-12014	305	012-14017	299
011-24804	254	012-10205	300	012-12015	305	012-14061	299
011-24805	254	012-11000	301	012-12016	305	012-14062	299
011-24806	254	012-11001	301	012-12017	305	012-14063	299
011-26422	252	012-11002	301	012-12061	305	012-14064	299
011-26423	252	012-11003	301	012-12062	305	012-14065	299
011-26424	252	012-11004	301	012-12063	305	012-14066	299
011-26425	252	012-11005	301	012-12064	305	012-14067	299
011-26472	252	012-11006	301	012-12065	305	012-14068	299
011-26473	252	012-11007	301	012-12066	305	012-14069	299
011-26474	252	012-11008	301	012-12067	305	012-14070	299
011-26475	252	012-11009	301	012-12068	305	012-14071	299
011-26821	254	012-11010	301	012-12069	305	012-14072	299
012-10001	300	012-11011	301	012-12070	305	012-14073	299
012-10002	300	012-11012	301	012-12071	305	012-14074	299
012-10003	300	012-11013	301	012-12072	305	012-14075	299
012-10004	300	012-11014	301	012-12073	305	012-14076	299
012-10005	300	012-11015	301	012-12074	305	012-14077	299
012-10006	300	012-11016	301	012-12075	305	012-14078	299
012-10007	300	012-11059	301	012-12076	305	012-14079	299
012-10008	300	012-11060	301	012-12181	305	012-14080	299
012-10009	300	012-11061	301	012-12182	305	012-14081	299
012-10010	300	012-11062	301	012-12183	305	012-14082	299
012-10011	300	012-11063	301	012-12184	305	012-14083	299
012-10012	300	012-11064	301	012-12185	305	012-14181	299
012-10013	300	012-11065	301	012-12186	305	012-14182	299
012-10014	300	012-11066	301	012-12187	305	012-14183	299
012-10015	300	012-11067	301	012-12188	305	012-14184	299
012-10016	300	012-11068	301	012-12189	305	012-14185	299
012-10017	300	012-11069	301	012-12190	305	012-14186	299
012-10060	300	012-11070	301	012-12191	305	012-14187	299
012-10061	300	012-11071	301	012-12192	305	012-14188	299
012-10062	300	012-11072	301	012-12193	305	012-14189	299
012-10063	300	012-11073	301	012-12194	305	012-14190	299
012-10064	300	012-11074	301	012-12195	305	012-14191	299
012-10065	300	012-11075	301	012-12196	305	012-14192	299
012-10066	300	012-11076	301	012-12197	305	012-14193	299
012-10067	300	012-11077	301	012-12198	305	012-14194	299
012-10068	300	012-11179	301	012-12199	305	012-14195	299
012-10069	300	012-11180	301	012-12201	305	012-14196	299
012-10070	300	012-11181	301	012-12202	305	012-14197	299
012-10071	300	012-11182	301	012-12203	305	012-14198	299
012-10072	300	012-11183	301	012-12400	308	012-14199	299
012-10073	300	012-11184	301	012-12401	308	012-14200	299
012-10074	300	012-11185	301	012-12402	308	012-14201	299

012-14202	299	012-23001	311	012-28022	296	012-S0069	300
012-14203	299	012-23002	311	012-28023	296	012-S0076	300
012-14204	299	012-23003	311	012-28024	296	012-S0080	300
012-14205	299	012-23004	311	012-28025	296	012-S0180	300
012-14900	312	012-23005	311	012-28026	296	012-S0181	300
012-14901	312	012-23006	311	012-28027	296	012-S0182	300
012-14902	312	012-23007	311	012-28028	296	012-S0183	300
012-14903	312	012-23010	311	012-28101	296	012-S0184	300
012-14904	312	012-23011	311	012-28102	296	012-S0185	300
012-14905	312	012-23012	311	012-28103	296	012-S0186	300
012-14906	312	012-23013	311	012-28104	296	012-S0189	300
012-15001	302	012-23014	311	012-28105	296	012-S0196	300
012-15002	302	012-23015	311	012-28106	296	012-S1000	301
012-15003	302	012-23016	311	012-28107	296	012-S1001	301
012-15004	302	012-23018	308	012-28108	296	012-S1002	301
012-15005	302	012-23033	312	012-28109	296	012-S1003	301
012-15006	302	012-23034	312	012-28110	296	012-S1004	301
012-15007	302	012-23035	312	012-28111	296	012-S1005	301
012-15008	302	012-23036	312	012-28112	296	012-S1006	301
012-15009	302	012-23037	312	012-28113	296	012-S1007	301
012-15010	302	012-23038	312	012-28114	296	012-S1014	301
012-15011	302	012-23039	312	012-28115	296	012-S1059	301
012-15012	302	012-23040	312	012-28116	296	012-S1060	301
012-15013	302	012-23041	312	012-28117	296	012-S1061	301
012-15014	302	012-23042	312	012-28118	296	012-S1062	301
012-15061	302	012-23043	312	012-28119	296	012-S1063	301
012-15062	302	012-23044	312	012-28201	296	012-S1064	301
012-15063	302	012-23045	312	012-28202	296	012-S1065	301
012-15064	302	012-23046	312	012-28203	296	012-S1073	301
012-15065	302	012-23160	312	012-28204	296	012-S1186	301
012-15066	302	012-23161	312	012-28205	296	012-S1193	301
012-15067	302	012-23162	312	012-28206	296	012-S14012	299
012-15068	302	012-23163	312	012-28207	296	012-S14013	299
012-15069	302	012-23164	312	012-28208	296	012-S2076	305
012-15070	302	012-23165	312	012-28209	296	012-S4002	299
012-15071	302	012-23166	312	012-28210	296	012-S4003	299
012-15072	302	012-23170	312	012-28211	296	012-S4004	299
012-15073	302	012-23171	312	012-28212	296	012-S4005	299
012-15074	302	012-23172	312	012-28213	296	012-S4006	299
012-15080	302	012-23173	312	012-28214	296	012-S4007	299
012-15081	302	012-23174	312	012-28215	296	012-S4008	299
012-15082	302	012-23175	312	012-28216	296	012-S4009	299
012-15083	302	012-23176	312	012-28217	296	012-S4010	299
012-15084	302	012-26001	304	012-28218	296	012-S4061	299
012-15085	302	012-26002	304	012-28219	296	012-S4062	299
012-15086	302	012-26003	304	012-28401	297	012-S4063	299
012-15087	302	012-26004	304	012-28402	297	012-S4064	299
012-15088	302	012-26005	304	012-28403	297	012-S4065	299
012-15089	302	012-26006	304	012-28405	297	012-S4066	299
012-15090	302	012-26007	304	012-S0001	300	012-S4067	299
012-15091	302	012-26008	304	012-S0002	300	012-S4068	299
012-15092	302	012-26009	304	012-S0003	300	012-S4069	299
012-15093	302	012-26010	304	012-S0004	300	012-S4070	299
012-15100	302	012-28001	296	012-S0005	300	012-S4076	299
012-15101	302	012-28002	296	012-S0006	300	012-S4189	299
012-15102	302	012-28003	296	012-S0007	300	012-S4196	299
012-15103	302	012-28004	296	012-S0008	300	012-S5001	302
012-15104	302	012-28005	296	012-S0009	300	012-S5002	302
012-15105	302	012-28006	296	012-S0010	300	012-S5003	302
012-15106	302	012-28007	296	012-S0011	300	012-S5004	302
012-15107	302	012-28008	296	012-S0012	300	012-S5005	302
012-15108	302	012-28009	296	012-S0013	300	012-S5006	302
012-15109	302	012-28010	296	012-S0014	300	012-S5007	302
012-15110	302	012-28011	296	012-S0015	300	012-S5014	302
012-15111	302	012-28012	296	012-S0016	300	012-S5061	302
012-15112	302	012-28013	296	012-S0060	300	012-S5062	302
012-15113	302	012-28014	296	012-S0061	300	012-S5063	302
012-19601	309	012-28015	296	012-S0062	300	012-S5064	302
012-19602	309	012-28016	296	012-S0063	300	012-S5065	302
012-19603	309	012-28017	296	012-S0064	300	012-S5066	302
012-19604	309	012-28018	296	012-S0065	300	012-S5067	302
012-19605	309	012-28019	296	012-S0066	300	012-S5068	302
012-19606	309	012-28020	296	012-S0067	300	012-S5074	302
012-19607	309	012-28021	296	012-S0068	300	012-S0070	300

012-S0071.....	300	017-24451.....	311	017-47275.....	316	017-51201.....	307
012-S0072.....	300	017-24480.....	311	017-47450.....	317	017-51202.....	307
012-S0073.....	300	017-24600.....	311	017-4750.....	317	017-51203.....	307
012-S0074.....	300	017-24601.....	311	017-4751.....	317	017-51204.....	307
012-S0075.....	300	017-24602.....	311	017-47510.....	317	017-51205.....	307
012-S1066.....	301	017-24603.....	311	017-47575.....	317	017-51206.....	307
013-24820.....	231	017-24620.....	310	017-47576.....	317	017-51207.....	307
013-24821.....	231	017-24621.....	310	017-47650.....	318	017-51208.....	307
013-25600.....	314	017-24622.....	310	017-48002.....	226	017-51209.....	307
013-25710.....	318	017-24623.....	310	017-48011.....	226	017-51210.....	307
013-25711.....	318	017-24630.....	310	017-48020.....	226	017-51211.....	307
013-25712.....	318	017-24631.....	310	017-48021.....	226	017-51212.....	307
013-25713.....	318	017-24632.....	310	017-48022.....	226	017-51213.....	307
013-29001.....	209	017-24633.....	310	017-48023.....	226	017-51214.....	307
013-29030.....	209	017-24800.....	254	017-48600.....	315	017-51220.....	307
013-29060.....	209	017-24801.....	254	017-48601.....	315	017-51221.....	307
013-33810.....	219	017-24802.....	254	017-48602.....	315	017-51222.....	307
013-38630.....	221	017-24803.....	254	017-48609.....	314	017-51223.....	307
013-38801.....	221	017-24840.....	231	017-48628.....	314	017-51224.....	307
013-38802.....	221	017-24841.....	231	017-48634.....	314	017-51225.....	307
013-38803.....	221	017-25504.....	318	017-48640.....	315	017-51226.....	307
013-38804.....	221	017-25505.....	318	017-48641.....	315	017-51227.....	307
013-97200.....	209	017-26805.....	255	017-48642.....	315	017-51228.....	307
013-97210.....	209	017-26806.....	255	017-48650.....	315	017-51229.....	307
017-19300.....	297	017-26807.....	255	017-48651.....	315	017-51230.....	307
017-19301.....	297	017-26808.....	255	017-48652.....	315	017-51231.....	307
017-19302.....	297	017-26810.....	255	017-48655.....	315	017-51232.....	307
017-19303.....	297	017-26811.....	255	017-48656.....	315	017-51240.....	307
017-19304.....	297	017-26842.....	254	017-48657.....	315	017-51241.....	307
017-19305.....	297	017-26844.....	254	017-51100.....	307	017-51242.....	307
017-19306.....	297	017-27541.....	292	017-51101.....	307	017-51243.....	307
017-19350.....	297	017-29310.....	209	017-51102.....	307	017-51244.....	307
017-19351.....	297	017-29320.....	196, 209, 258	017-51103.....	307	017-51245.....	307
017-19352.....	297	017-29321.....	209	017-51104.....	307	017-51246.....	307
017-19353.....	297	017-29330.....	209	017-51105.....	307	017-51247.....	307
017-19354.....	297	017-29331.....	209	017-51106.....	307	017-51248.....	307
017-19355.....	297	017-29340.....	209	017-51107.....	307	017-51249.....	307
017-19356.....	297	017-29341.....	209	017-51108.....	307	017-51250.....	307
017-19400.....	297	017-33700.....	212	017-51109.....	307	017-51260.....	307
017-19401.....	297	017-33701.....	212	017-51110.....	307	017-51261.....	307
017-19402.....	297	017-33702.....	212	017-51111.....	307	017-51262.....	307
017-19403.....	297	017-33703.....	212	017-51112.....	307	017-51263.....	307
017-19404.....	297	017-33820.....	219	017-51113.....	307	017-51264.....	307
017-19405.....	297	017-33825.....	219	017-51114.....	307	017-51265.....	307
017-19406.....	297	017-33830.....	219	017-51120.....	307	017-51266.....	307
017-19510.....	309	017-33835.....	219	017-51121.....	307	017-97204.....	209
017-19511.....	309	017-36295.....	298	017-51122.....	307	033-39210.....	306
017-19512.....	309	017-36296.....	298	017-51123.....	307	033-39210P.....	306
017-19513.....	309	017-36300.....	298	017-51124.....	307	033-39211P.....	306
017-19514.....	309	017-36307.....	298	017-51125.....	307	033-39214.....	306
017-19515.....	309	017-36308.....	298	017-51126.....	307	033-39214P.....	306
017-19516.....	309	017-36309.....	309	017-51127.....	307	033-39215P.....	306
017-19517.....	309	017-36352.....	297	017-51128.....	307	1-200.....	177
017-19518.....	309	017-36400.....	298	017-51129.....	307	1-202.....	177
017-19519.....	309	017-36401.....	298	017-51130.....	307	1-208.....	177
017-23400.....	318	017-36402.....	298	017-51131.....	307	1-212.....	177
017-23500.....	232	017-36403.....	298	017-51132.....	307	1-213.....	177
017-23501.....	232	017-36404.....	298	017-51133.....	307	1-214.....	177
017-23502.....	232	017-36406.....	298	017-51134.....	307	1-220.....	177
017-23503.....	232	017-37100.....	318	017-51140.....	307	1-3015.....	175
017-23550.....	232	017-37101.....	318	017-51141.....	307	1-3200.....	175
017-23551.....	232	017-38640.....	221	017-51142.....	307	1-5000.....	179
017-23552.....	232	017-38811.....	221	017-51143.....	307	1-5001.....	179
017-23553.....	232	017-38812.....	221	017-51144.....	307	1-5002.....	179
017-24200.....	293	017-38813.....	221	017-51145.....	307	1-5003.....	179
017-24204.....	293	017-38814.....	221	017-51146.....	307	1-5004.....	179
017-24205.....	293	017-39211.....	306	017-51160.....	307	1-5005.....	179
017-24211.....	293	017-39211P.....	306	017-51161.....	307	1-5006.....	179
017-24212.....	293	017-39960.....	227	017-51162.....	307	1-5007.....	179
017-24440.....	311	017-41710.....	226	017-51163.....	307	1-5008.....	179
017-24441.....	311	017-41730.....	226	017-51164.....	307	1-5009.....	179
017-24442.....	311	017-47150.....	316	017-51165.....	307	1-5010.....	179
017-24445.....	311	017-47160.....	316	017-51166.....	307	1-5011.....	179
017-24450.....	311	017-47270.....	316	017-51200.....	307	1-5012.....	179

1-5013	179	3-902	530	3-2507V	514	4-310	501
1-5014	179	3-903	530	3-2508	514	4-311	501
1-5015	179	3-904	530	3-2508C	514	4-312	501
1-5016	179	3-905	530	3-2508T	514	4-312B	501
1-5017	179	3-906	530	3-2508V	514	4-315	501
1-5018	179	3-907	530	3-2509	514	4-315C	501
1-5019	179	3-908	530	3-2509C	514	4-320	501
1-5020	179	3-909	530	3-2509T	514	4-321	501
1-5021	179	3-910	530	3-2509V	514	4-322	501
2-50	183	3-912	530	3-2510	514	4-323	501
2-60	183	3-913	530	3-2510C	514	4-325	501
2-62	183	3-914	530	3-2510T	514	4-400	501
2-70	183	3-915	531	3-2510V	514	4-401	501
2-72	183	3-916	531	3-6815	424, 428	4-405	501
2-104SS	188	3-917	531	3-6835	337, 362	4-410	500
2-106SS	188	3-918	531	3-6845	376	4-411	500
2-109	188	3-919	531	3-072007	259, 335, 519	4-412	500
2-110SS	188	3-920	531	3-072014	519	4-415	500
2-111SS	188	3-921	531	3-080205	522	4-420	500
2-154	18, 228	3-922	531	3-082008	519	4-421	500
3-2	527	3-924	531	3-083005	262, 339, 516	4-422	500
3-4	527	3-925	531	3-083105	516	4-423	500
3-10	527	3-926	531	3-083210	516	4-510	500
3-14	527	3-927	531	3-084007	260, 262, 339, 340, 516	4-511	500
3-20	527	3-929	531	3-084107	235, 342, 516	4-512	500
3-22	528	3-930	531	3-084214	516	4-515	500
3-24	527	3-934	531	3-085009	257, 338, 517	4-515C	500
3-26	528	3-935	531	3-085109	517	4-522	500
3-50	133, 528	3-936	531	3-085218	517	4-6815	515
3-60	524	3-937	532	3-089110	517	4-6815MAT	515
3-70	524	3-938	532	3-089110A	517	4-6835	337, 344, 515
3-71	524	3-939	532	3-089110L	517	4-6835MAT	337, 344, 515
3-72	524	3-940	532	3-089110S	517	4-008115	515
3-74	524	3-941	532	3-118114	517	4-008122	515
3-75	524	3-942	532	3-118114A	517	4-008122MAT	515
3-76	524	3-943	532	3-118114A	517	4-009126	515
3-77	524	3-944	532	3-118114L	517	4-009126MAT	515
3-78	524	3-945	532	3-118114S	517	4-083000	515
3-79	524	3-946	532	3-118116	518	4-083000MAT	515
3-80	524	3-947	532	3-118116A	518	4-084000	515
3-81	524	3-948	532	3-118116L	518	4-084000MAT	515
3-82	524	3-949	532	3-118116S	518	4-085000	515
3-83	524	3-953	531	3-118122	518	4-085000MAT	515
3-84	524	3-954	531	3-139126	518	4-089100	515
3-85	524	3-955	531	3-200100	514	4-089100MAT	515
3-86	524	3-1000	511	3-200200	514	5-2	18
3-87	524	3-1001	511	3-200300	514	5-4	18
3-88	524	3-2501	514	4-7	257, 337, 338, 362, 424, 501	5-6	18
3-89	524	3-2501C	514	4-7R	501	5-6TC	4
3-90	524	3-2501T	514	4-8	501	5-7	18
3-91	524	3-2501V	514	4-8R	501	5-8	18
3-92	524	3-2502	514	4-9	501	5-12	18
3-93	524	3-2502C	514	4-10	501	5-14	18
3-94	524	3-2502T	514	4-11	501	5-16	18, 257, 338
3-95	524	3-2502V	514	4-12	501	5-17	18
3-96	524	3-2503	514	4-16	501	5-18	18
3-97	524	3-2503C	514	4-17	501	5-19	18
3-98	524	3-2503T	514	4-18	501	5-22	18
3-99	524	3-2503V	514	4-20	501	5-24	18
3-499	523	3-2504	514	4-30	501	5-26	18
3-700	509	3-2504C	514	4-31	501	5-26TC	4
3-705	509	3-2504T	514	4-100	501	5-27	18
3-710	509	3-2504V	514	4-110	501	5-28	18
3-720	508	3-2505	514	4-111	501	5-32	18
3-725	508	3-2505C	514	4-112	501	5-34	18
3-726	508	3-2505T	514	4-112B	501	5-36	18
3-740	510	3-2505V	514	4-115	501	5-36TC	4
3-750	508	3-2506	514	4-115C	501	5-37	18
3-755	508	3-2506C	514	4-120	501	5-38	18
3-760	508	3-2506T	514	4-121	501	5-42	18
3-800	510	3-2506V	514	4-122	501	5-44	18
3-810	510-511	3-2507	514	4-123	501	5-46	18
3-900	530	3-2507C	514	4-125	501	5-46TC	4
3-901	530	3-2507T	514			5-48	18

5-49	18	5-180B-TC	10	5-300	39, 337, 344	6-14	57
5-52	18	5-180TC	8	5-302	39	6-16	57
5-54	18	5-181	22	5-304	39	6-18	57
5-56	18	5-181A-TC	10	5-304TC	5	6-24	57
5-56TC	4	5-181B-TC	10	5-306	39	6-26	57
5-58	18	5-181TC	9	5-306TC	5	6-28	57
5-60	19	5-182	22, 424	5-308	39	6-28XL	57
5-61	19	5-182A-TC	10	5-310	39	6-30	57
5-62	19	5-182B-TC	10	5-312	39, 365	6-40	58
5-63	19	5-182TC	9	5-312TC	11	6-42	58
5-64	19	5-183	22	5-314	39	6-44	58, 424
5-65	19	5-184	22	5-314TC	11	6-44XL	58
5-70	19	5-184TC	9	5-316	39	6-46	58
5-72	19	5-185	22	5-318	39	6-47	58
5-73	19	5-186	22	5-320	31	6-48	58
5-74	19	5-186TC	9	5-320TC	11	6-50	58
5-76	19	5-187	22	5-510	47	6-52	58
5-77	19	5-187TC	10	5-512	47	6-60	58
5-80	19	5-188	22	5-514	47	6-62	58
5-82	19	5-188TC	9	5-516	47	6-64	58
5-84	19	5-189	22	5-547	47	6-66	58
5-86	19	5-189A-TC	9	5-550	47	6-72	58
5-88	19	5-189TC	10	5-560	48	6-74	58
5-90	19	5-190	22	5-561	48	6-76	58
5-100	20	5-192	22	5-564	48	6-82	58
5-102	20	5-192TC	9	5-568	48	6-84	58
5-104	20	5-193	22	5-600	49	6-86	58
5-106	20	5-193A-TC	9	5-700	49	6-8XL	57
5-108	20	5-194	22	5-702	49	6-90	58
5-112	20	5-196	22	5-800	49	6-92	58
5-114	20	5-200	29	5-998	49	6-94	58
5-115	21	5-202	29	5-1000	49	6-96	58
5-116	21	5-220	29	5-1025	49	6-100	60
5-120	21	5-222	29	5-1026	49	6-104	60
5-120TC	6	5-226	29	5-1027	49	6-106	60
5-122	21	5-243	29	5-1028	49	6-107	60
5-122TC	6	5-244	29	5-1029	49	6-108	60
5-124	21, 424	5-245	29	5-1030	49	6-109	60
5-124TC	6	5-246	24	5-5000	513	6-109A	60
5-126	21	5-247	24	5D-251	25	6-110	61
5-126TC	6	5-248	24	5D-253	25	6-112	61
5-128	21	5-249A	24	5D-255	25	6-113TC	54
5-128TC	6	5-249B	24	5D-303	39	6-114	61
5-130	21	5-249C	24	5D-322	31	6-115TC	54
5-130TC	6	5-250	25	5D-324	31, 257, 338	6-118	61
5-132	21	5-252	25	5-SC-16	4	6-118A	61
5-134	21	5-254	25	5-SC-46	4	6-118TC	54
5-136	21	5-256	25	5-SC-120	6	6-118XL	61
5-136TC	7	5-262	25	5-SC-122	6	6-120	62
5-138	21	5-263	25	5-SC-124	6	6-120A	62
5-138TC	7	5-264	26	5-SC-126	6	6-120XL	62
5-140	21	5-265	26	5-SC-128	6	6-121	62
5-140TC	7	5-266	26	5-SC-130	6	6-122	62
5-142	21	5-267	26	5-SC-179	8	6-123	62
5-142TC	7	5-268	26	5-SC-180	8	6-123TC	54
5-144	23	5-269TC	14	5-SC-182	9	6-123XL	62
5-146	23	5-270	28	5-SC-182TC	9	6-124	62, 257, 338, 424
5-148	23	5-271	28	5-SC-188	9	6-124TC	55
5-150	23	5-272	28	5-SC-270	11	6-124XL	62
5-152	23	5-273	28	5-SC-276	11	6-125	63
5-154	23	5-274	28	5-SC-283	8	6-126	63
5-160	23	5-275	28	5-SC-284	8	6-128	63
5-162	23	5-276	28	5-SC-290	11	6-129TC	54
5-16TC	4	5-277	28	5-SC-304	5	6-130TC	55
5-172	24	5-278	28	5-SC-304TC	5	6-132	63
5-174	24	5-279	28	5-SC-306	5	6-134	63
5-176	24	5-280	28	5-SC-306TC	5	6-136	63
5-178	24	5-281	28	5-SC-320	11	6-138	64
5-179	22	5-283	22	6-2	57	6-140	64
5-179A-TC	10	5-284	22	6-4	57	6-141	64
5-179B-TC	10	5-286	22	6-6	57	6-142	64
5-179TC	8	5-288	22	6-8	57	6-144	64
5-180	22	5-290	26	6-10	57	6-145	64
5-180A-TC	10	5-291	26	6-12	57	6-148	64

6-150	64	7-66	97	7-292	100	8-15	118
6-154	64	7-68	97	7-294	100	8-15CG	115
6-154TC	55	7-70	86	7-296	100	8-15TC	107, 257, 338, 424
6-156	64	7-72	86	7-298	100	8-16CG	115
6-156TC	55	7-82	87	7-300	100	8-16TC	107, 424, 428
6-158	64	7-84	87	7-302	100	8-20	118
6-158TC	55	7-90	87	7-304	100	8-22	119
6-159	64	7-91	87	7-305	100	8-23	119
6-160	64	7-92	87	7-310	100	8-26	119, 371
6-162	64	7-94	87	7-315	100	8-28	119
6-164	64	7-98	87	7-500	101	8-28TC	107
6-164A	64	7-102	87	7-501	101	8-30	119
6-165TC	55	7-106	87	7-504	101, 424	8-30TC	107
6-166	65	7-110	98	7-506	101	8-32	119
6-166TC	55	7-112	98	7-510	101, 379	8-40	119
6-168	65	7-118	98	7-514	101	8-40CG	116
6-180	65	7-120	98	7-515	101	8-40TC	107
6-182	65	7-122	98	7-600	102, 357	8-42	120
6-184	65	7-124	98	7-602	102, 357	8-42CG	116
6-186	65	7-126	98	7-604	102, 357	8-42TC	108
6-188	65	7-128	98	7-606	102, 357	8-44	120
6-189	65	7-130	98	7-610	102, 357	8-44CG	116
6-190	66	7-136	98	7-612	102, 357	8-44TC	108
6-192	66	7-138	98	7-614	102, 357	8-46	120
6-197	66, 328	7-140	98	7-616	102, 357	8-46CG	116
6-198	66, 328	7-142	98	7-620	103, 358	8-46TC	108
6-198TC	55	7-144	98	7-622	103, 358	8-48	120
6-200	66	7-146	98	7-624	103, 358	8-48CG	116
6-202	66	7-148	98	7-630	103, 358	8-48TC	108
6-204	66	7-150	99	7-632	103, 358	8-49TC	108
6-210	66	7-152	99	8-2	117	8-50	120
6-212	67	7-154	99	8-3TC	106	8-50A-TC	108
6-214	67	7-156	99	8-4	117, 344, 337	8-50CG	116
6-300	77	7-157	99	8-4CG	115	8-50TC	108
6-302	77	7-160	99	8-4TC	106, 352	8-51	120
6-304	77	7-162	99	8-5TC	106	8-51CG	116
6-308	77	7-164	99	8-6	117	8-51TC	109
6-30TC	54	7-166	99	8-6CG	115	8-52	120
6-310	77	7-167	99	8-6TC	106	8-52CG	116
6-312	77	7-170	99	8-7	117	8-52TC	109
6-314	77	7-172	99, 424	8-7A-TC	106	8-53	120
6-316	77	7-180	99	8-7CG	115	8-53TC	109
6-318	77	7-182	99	8-7TC	106	8-55TC	109
6-330	78	7-190	97	8-8	117	8-57TC	109
6-336	78	7-200	89	8-8A-TC	106	8-58	120
6-337	78	7-202	89	8-8CG	115	8-59	120
6-338	78, 291, 313	7-206	89	8-8TC	106	8-62TC	109
6-340	78, 291, 313	7-210	90	8-10	118	8-63TC	109
6-342	78, 291, 313	7-210A	90	8-12	118	8-65TC	109
6-350	78, 291, 313	7-220	92	8-14	118	8-66TC	109
6-400	78	7-230	93	8-16	118	8-67TC	109
7-2	84	7-232	93	8-17	118	8-69TC	109
7-4	84, 424	7-234	93	8-17TC	107	8-70	121
7-8	84, 369	7-236	93	8-100	122	8-706TC	114
7-10	84, 369	7-240	93	8-100TC	110	8-74	121
7-11	84	7-242	93	8-101TC	111	8-744TC	114
7-12	84	7-24A	85	8-102	122	8-746TC	114
7-14	85	7-250	85	8-102TC	110	8-748TC	114
7-16	85	7-252	85	8-103TC	111	8-750TC	114
7-20	85, 291, 313	7-254	85	8-104TC	111	8-751TC	114
7-24	85, 369	7-255	95	8-105TC	111	8-752TC	114
7-26	85, 369	7-256	95	8-106TC	111	8-753TC	114
7-30	86	7-257	95	8-107TC	111	8-76	121
7-32	86	7-258	95	8-114	122	8-80	121
7-36	86	7-259	95	8-114TC	110	8-81TC	109
7-38	86, 424	7-260	96	8-122	123	8-82TC	110
7-42	86	7-262	96	8-130	120	8-83TC	110
7-44	86	7-264	96	8-130TC	108	8-84	121
7-46	86	7-266	96	8-134	123	8-94	121
7-48	86	7-280	100	8-134TC	111	8-96	122
7-50	86	7-282	100	8-136	123	8-96TC	110
7-52	86	7-284	100	8-14A	118	8D-36	117
7-60	87	7-286	100	8-14A-TC	107	9-1	128
7-62	87	7-290	100	8-14TC	107, 352	9-2	128

9-4	128	10-12-NS	166	11-136	140	11-618	150
9-6	128	10-12-ST	166	11-140	140	11-620	150
9-8	128	10-14-NS	166	11-144	140	11-622	150
9-10	128	10-14-ST	166	11-146	140	11-625	150
9-32	128	10-22-SS	166	11-152	140	11-630-BL	150
9-40-18	133, 384	10-22-ST	166	11-153	140	11-630-SH	150
9-40-20	133, 376, 384	10-24-SS	166	11-154	140	11-634-BL	150
9-40-22	133, 384	10-24-ST	166	11-155	140	11-634-SH	150
9-40-24	133, 384	10-26-SS	166	11-160	141	11-642-BL	150
9-40-25	133, 384	10-26-ST	166	11-162	141	11-642-SH	150
9-40-26	133, 384	10-28-SS	166	11-164	141	11-650	150
9-40-28	133, 384	10-28-ST	166	11-166	141	11-652	150
9-40-30	133, 376, 384	10-30-SS	166	11-202	141	11-654	150
9-40-32	133, 384	10-30-ST	166	11-206	141	11-656	150
9-40-34	133, 384	10-32-SS	166	11-208	141	11-672	151
9-40-36	133, 384	10-32-ST	166	11-210	141	11-676	151
9-44-18	133, 384	10-34-SS	166	11-218	141	13-2	173
9-44-20	133, 384	10-34-ST	166	11-219	141	13-8	173
9-44-22	133, 384	10-38	166	11-220	141	13-9	173
9-44-24	133, 384	10-79	166	11-240	141	13-10	173
9-44-25	133, 384	10-80	166	11-242	141	13-11	173
9-44-26	133, 384	10-82	166	11-244	141	13-20	173
9-44-28	133, 384	10-84	166	11-250	141	13-62	173
9-44-30	133, 384	10-220	188	11-252	141	13-64	173
9-44-32	133, 384	10-310	187	11-254	141	13-66	173
9-44-34	133, 384	10-312	187	11-256	141	13-68	173
9-50	128	11-2	146	11-350	142, 386	13-70	173
9-52	128	11-4	146	11-352	142, 386	13-72	173
9-54	128	11-6	147	11-36	138	13-74	173
9-60	128	11-8	147	11-365	148	14-4-15	168
9-62	128	11-10	147	11-366	148	14-4-18	168
9-90	128	11-12	147	11-368	148	14-8	168
9-94	128	11-13	147	11-374	148	14-10-3	168
9-96	34, 129	11-14	147	11-400	148	14-10-4	168
9-98	34, 129	11-16	147	11-402	148	14-10-5	168
9-100	35, 130, 365	11-19	147	11-404	148	14-10-6	168
9-101	35, 130, 365	11-30	138	11-420	149	14-10-7	168
9-102	35, 130	11-32	138	11-421	149	14-10-8	168
9-103	35, 130	11-34	138	11-424	149	14-10-9	168
9-104	35, 130	11-38	138	11-428	149	14-10-10	168
9-106	36, 130	11-40	138	11-430	149	14-10-11	168
9-108	36, 130	11-42	137	11-432	149	14-12	168
9-110	130	11-43	137	11-44	137	14-22	171
9-115	36, 130	11-45	137	11-440	149	14-24-17	171
9-116	36	11-46	137	11-442	149	14-24-21	171
9-117	36	11-47	137	11-444	149	14-24-24	171
9-120	37, 131	11-48	137	11-446	149	14-24-27	171
9-122	37, 131	11-49	137	11-448	149	14-26-L	171
9-124	37, 131, 376	11-50	138	11-500	157, 385	14-26-M	171
9-124TC	16, 131	11-52	138	11-502	157, 385	14-26-S	171
9-128	131, 381	11-54	138	11-504	143, 387	14-27	171
9-140	132	11-56	138	11-506	143, 387	14-28	171
9-142	132	11-58	138	11-508	143, 387	14-29	171
9-146	132	11-74	139, 376	11-512	143, 387	14-46	91
9-148	132	11-76	139, 376	11-514	143, 387	14-48	91
9-154	132	11-78	139	11-516	143, 387	14-49	91
9-156	132	11-80	139	11-530	143, 387	14-50	91
9D-115	36	11-81	139	11-532	143, 387	14-51	91
9D-121	37, 131	11-82	139, 153	11-534	143, 387	14-52	91
9D-123	37, 131	11-88	137	11-536	143, 387	14-56	91
9D-132	37, 131	11-90	137	11-538	143, 387	14-62	91
9D-133	37, 131	11-92	137	11-540	143, 387	14-66	92
9D-134	37, 131	11-94	137	11-542	143, 387	16-3	94
9D-135	37, 131	11-96	137	11-544	143, 387	16-4	94
10-2-NS	166	11-102	140	11-590	139	16-6	94
10-2-ST	166, 344, 337	11-110	140	11-60	138	16-42	94
10-4-NS	166	11-112	140	11-600	150	16-44	94
10-4-ST	166	11-114	140	11-602	150	16-46	94
10-6-NS	166	11-116	140	11-608	150, 376	16-48	94
10-6-ST	166	11-120	140	11-610	150	16-80	67
10-8-NS	166	11-122	140	11-611	150	16-99	94
10-8-ST	166	11-130	140	11-614	150	16-100	94
10-10-NS	166	11-132	140	11-616	150	16-102	94
10-10-ST	166	11-134	140	11-617	150	16-108	94

16-11094	18-46 145, 354, 372	18-79568	18-1182 370
16-120 97	18-47145, 354, 373	18-795A68	18-1200 370
16-122 97	18-50 145, 354, 373	18-79668	18-1202 337, 362, 370
16-130 94	18-63 145, 355, 373	18-79868	18-1204 370
16-132 94	18-64 145, 373	18-80468	18-1208 370
16-140 95	18-66 145, 355, 373	18-814 69, 368	18-1220 370
16-160 95	18-68 145, 373	18-816 69, 368	18-1392 38
16-162 95	18-80 146, 355	18-818 69	18-1394 38
17-115 346	18-84 146, 355	18-820 69	18-1396 38
17-215 346	18-88 146, 355	18-825 69	18-1398 38
17-220 346	18-96 146	18-827 69, 368	18-1404 38
17-301 80, 349	18-100 138	18-828 69, 368	18-1405 38
17-302 80, 349	18-102 138	18-829 69	18-1415 38
17-303 80, 349	18-110 138, 373	18-830 69	18-1416 38
17-303C 80, 349	18-112 138, 373	18-834 69	18-1417 38
17-303X 80, 349	18-114 138, 373	18-835 69, 348, 368	18-1418 38
17-304 80, 349	18-116 138, 373	18-836 70, 348, 368	18-1419 38
17-305 81, 349	18-120 364	18-837 70, 348	18-1420 38
17-305X 81, 337, 344, 349	18-132 363	18-838 70, 348	18-1422 38
17-306 81, 350	18-132A 363	18-840 70	18-1426 38
17-307 81, 350	18-134 363	18-850 70, 368	18-1428 38
17-307X 81, 350	18-134A 363	18-852 70, 368	18-1430 30
17-980 124, 352	18-139 363	18-854 70, 368	18-1432 30
17-1000 124, 352	18-330 367	18-860 70	18-1440 30
17-1010 124, 352	18-331 367	18-866 70, 368	18-1440TC 16
17-1020 124, 352	18-350 367	18-867 70, 368	18-1453 30
17-1024 124, 352	18-370 367	18-868 70, 368	18-1454 30
17-1025 124, 352	18-372 367	18-880 71	18-1455 30
17-1090TC 112, 352	18-374 367	18-881 71	18-1456 30
17-1091TC 112, 352	18-376 367	18-883 71	18-1460 30, 365
17-1092TC 112, 352	18-412 153	18-896 71	18-1462 30, 337, 362, 365
17-1100 67, 350	18-414 153	18-897 71	18-1464 30, 365
17-1150 67, 350	18-416 153	18-904 71	18-1466 30, 365
17-2040 43, 345	18-418 153	18-906 71	18-1470 30, 365
17-2060 43, 345	18-420 153	18-912 71	18-1472 30, 365
17-2100 43, 345	18-439 138	18-914 71	18-1474 30, 365
17-2110 43, 345	18-450 153	18-916 72	18-1476 30, 365
17-2150 43, 345	18-452 153	18-946 72, 368	18-1477 30
17-2160 43, 345	18-454 153	18-947 72, 368	18-1478 30
17-2500 348	18-620 68	18-948 72, 337, 344, 350	18-1480 43
17-2510 61, 348	18-624 68	18-949 72, 350	18-1485 366
17-2600 84, 348, 369	18-628 369	18-950 72	18-1486 43, 130
17-2602 84, 348, 369	18-632 68	18-951 72	18-1487 43
17-2603 93	18-650 175, 364	18-952 72	18-1488 43
17-4000 347	18-657 175	18-953 72	18-1494 40
17-4005 347	18-658 175	18-954 72	18-1496 40
17-4010 347	18-660 175	18-955 72	18-1498 40
17-4015 347	18-710 167	18-956 72	18-1510 42
17-4030 347	18-712 167	18-958 72	18-1512 42
17-4050 347	18-714 167	18-962 73	18-1514 42
17-4060 347	18-716 167	18-964 73	18-1516 42
17-4070 347	18-718 167	18-966 73	18-1524 42
17-4100 347	18-720 167	18-970 73	18-1554 42
17-4102 347	18-740 167	18-971 73	18-1558 42
17-4800 353, 414	18-742 167	18-974 73	18-1559 42
17-4801 287, 353, 414	18-744 167	18-975 73	18-1560 44
17D-4802 287, 353, 414	18-746 167	18-978 73	18-1562 44
18-2 144, 354	18-748 167	18-980 81	18-1565 366
18-4 144, 354	18-750 167	18-SC-1470 5	18-1566 366
18-9 372	18-779 57	18-SC-1472 5	18-1567 366
18-10 144, 354	18-780 57, 337, 362, 369	18-SC-1474 5	18-1568 366
18-12 144	18-781 57	18-SC-1476 5	18-1570 44
18-14 144	18-782 57, 369	18-SC-1652 11	18-1576 44
18-17 372	18-783 57	18-1100 73	18-1578 44
18-18 372	18-784 57, 369	18-1102 73, 370	18-1579 366
18-22 144, 354	18-785 59	18-1104 73	18-1580 366
18-24 144, 354	18-786 59, 369	18-1106 74	18-1591 366
18-33 144	18-787 59	18-1107 74, 370	18-1592 366
18-34 144, 337, 344, 372	18-788 59, 369	18-1110 74	18-1594 41
18-35 145, 337, 354, 362, 372	18-789 59	18-1111 74	18-1600 41
18-36 145, 372	18-790 59, 369	18-1112 74, 370	18-1618 44, 346
18-40 145	18-791 59	18-1114 74	18-1619 44, 346
18-44 145	18-793 68	18-1116 74	18-1620 41
18-45 145	18-794 68	18-1170 370	18-1622 41

18-1625	44, 337, 344, 345	19-292	324	19-736	405	19-2522	327
18-1626	44, 345	19-294	324	19-737	405	19-2523	327
18-1630	44, 345	19-296	324	19-738	405	19-2524	327
18-1631	44, 345	19-298	324	19-750	394	19-2525	327
18-1633	44, 345	19-314	324	19-752	394	19-2526	327
18-1634	44, 345	19-316	324	19-754	394	19-2527	327
18-1652	44, 129	19-318	324	19-756	394	19-2528	325
18-1653	44, 129	19-320	324, 499	19-758	394	19-2529	325
18-1800	125	19-321	324, 499	19-760	394	19-2530	325
18-1810	125	19-322	324, 499	19-770	394	20-2	180
18-1816TC	111	19-323	324, 499	19-772	394	20-3	180
18-1820	125	19-350	75, 328	19-774	394	20-4	180, 359
18-1824	125	19-356	75, 328	19-776	394	20-6	180
18-1828	125, 337, 362	19-360	75, 328	19-778	394	20-7	180
18-1828A-TC	112	19-370	75, 328	19-780	394	20-12	359
18-1828TC	112	19-371	75, 328	19-790	396	20-28	180
18-1831	125	19-404	322	19-792	376, 396	20-32	180
18-1832	125	19-415	323	19-793	396	21-60	401
18-1832A-TC	112	19-416	323	19-794	396	21-62	401
18-1832TC	112	19-417	323	19-795	396	21-63	401
18-1833	125	19-418	323	19-796	397	21-64	401
18-1834	126	19-420	323	19-797	397	21-68	401
18-1837	126, 371	19-421	323	19-804	411	21-72	401
18-1838	126	19-422	323	19-808	411	21-88	154
18-1839	126	19-434	322	19-840	412	21-89	154
18-1840	126	19-437	322	19-844	412	20-100	167
18-1850	371	19-438	322	19-848	412	20-102	167
18-1852	371	19-439	322	19-849	412	20-120	75
18-1853	371	19-442	322	19-850	412	20-168	41
18-1854	371	19-480	323	19-852	412	20-170	46
18-1856	371	19-481	323	19-854	412	20-171	46
18-1864	126	19-505	325	19-856	412	20-172	46
18-1865	126	19-506	325	19-1230	414	20-230	401
18-1866	126	19-562	187	19-1232	414	20-420	185
18-1867	126	19-563	187	19-1820	189	20-428	185
18-1934	84	19-564	187	19-2081	321, 351	20-430	185
18-1936	84	19-565	187	19-2081-B	321, 351	20-460	187
18-1968	268, 376, 401	19-570	187	19-2090	321, 351	20-466	187
18-1990	414	19-572	187	19-2090-B	321, 351	21-102	154
18-1992	414	19-573	187	19-2100	321, 351	21-103	154
18-1994	414	19-574	187	19-2100-B	321, 351	21-107	137
18-1996	414	19-575	187	19-2110	321, 351	21-144	154
19-100	178	19-576	187	19-2110-B	321, 351	21-150	139
19-102	178	19-577	187	19-2114	323	21-152	154
19-104	178	19-580	189	19-2115	323	21-153	155
19-106	178	19-582	189	19-2116	323	21-154	155
19-108	178	19-584	189	19-2117	323	21-156	155
19-110	178	19-589	189	19-2118	323	21-158	155
19-112	178	19-700	406	19-2119	323	21-160	155
19-120	178	19-702	406	19-2138	321, 351	21-321	407
19-120A	178	19-704	406	19-2150	351	21-322	407
19-210	167	19-706	406	19-2150-B	321, 351	21-330	162
19-211	326	19-708	376, 406	19-2155	46, 323	21-338	162
19-212	326	19-710	406	19-2156	46, 323	21-342	162
19-220	153	19-712	406	19-2157	46, 323	21-343	162
19-222	153	19-714	406	19-2158	46, 323	21-346	162
19-226	154	19-716	406	19-2159	46, 323	21-348	162
19-228	154	19-718	406	19-2160	46, 323	21-352	162
19-260	324	19-720	406	19-2500	327	21-354	162
19-262	324	19-721	405	19-2501	327	21-360	163, 398
19-264	324	19-722	405	19-2502	327	21-368	163, 398
19-266	324	19-723	405	19-2503	327	21-369	163, 376, 398
19-268	324	19-724	405	19-2504	325	21-370	163, 398
19-270	324	19-725	405	19-2505	326	21-379	511
19-272	324	19-726	405	19-2510	326	21-380TC	160
19-274	324	19-727	405	19-2511	326	21-381TC	160
19-276	324	19-728	405	19-2512	326	21-382TC	160
19-278	324	19-729	405	19-2513	326	21-383TC	160
19-280	324	19-730	405	19-2514	326	21-384TC	160
19-282	324	19-731	405	19-2515	326	21-385TC	160
19-284	324	19-732	405	19-2516	326	21-386TC	160
19-286	324	19-733	405	19-2517	326	21-387TC	160
19-288	324	19-734	405	19-2518	327	21-388TC	160
19-290	324	19-735	405	19-2520	327	21-389TC	160

21-390TC.....	160	23-1158SS.....	186	26-132.....	417	27-46.....	379
21-391TC.....	160	23-1159SS.....	186	26-134.....	417	27-47.....	379
21-392DC.....	161, 399	23-1199SS.....	186	26-138.....	417	27-70.....	380
21-393DC.....	161, 399	23-1200SS.....	186	26-140.....	417	27-80.....	380
21-394TC.....	161, 399	23-1202SS.....	186	26-141.....	417	27-83.....	407
21-430.....	155	23-1204SS.....	186	26-142.....	417	27-84.....	407
21-536.....	129	23-1206SS.....	186	26-143.....	417	27-85.....	407
21-537TC.....	16	23-1208SS.....	186	26-190.....	411	27-93.....	380
21-539.....	41	23-1210SS.....	186	26-192.....	411	27-95.....	380
21-560.....	41, 48	23-1212SS.....	186	26-264.....	413	27-110.....	132, 383
21-600.....	41	23-1214SS.....	186	26-265.....	413	27-158.....	376, 381
21-602.....	41	23-1216SS.....	186	26-266.....	413	27-159TC.....	382
21-604TC.....	16	23-1218SS.....	186	26-780.....	189	27-160.....	381
21-605.....	32	23-1219SS.....	186	26-782.....	189	27-161TC.....	382
21-607.....	32	23-1240SS.....	186	26-956.....	76	27-163TC.....	382
21-608.....	32	23-1243SS.....	186	26-958.....	76	27-164TC.....	382
21-608TC.....	12	23-1244SS.....	186	26-1080.....	156	27-165TC.....	382
21-626.....	415	23-1245SS.....	186	26-1084.....	156	27-176TC.....	131
21-627.....	415	23-1246SS.....	186	26-1086.....	156	27-176TC.....	382
21-628.....	415	23-1247SS.....	186	26-1090.....	156	27-182.....	383
21-710TC.....	15	23-1248SS.....	186	26-1092.....	156	27-183.....	383
21-715TC.....	13	23-1249SS.....	186	26-1150.....	156	27-184.....	383
21-740TC.....	14	23-1250SS.....	186	26-1156.....	156	27-185.....	383
21-742TC.....	14	23-1251SS.....	186	26-1170.....	156	27-186.....	383
21-900.....	132	23-1600.....	186, 511	26-1410.....	402	27-187.....	383
21-901.....	132	23-1602.....	186, 511	26-1412.....	402	27-188.....	383
21-902.....	132	24-550.....	76	26-1430.....	402	27-189.....	383
21-SC-600.....	16	24-552.....	76	26-1432.....	402	27-190.....	383
21-SC-607.....	12	24-554.....	76	26-1434.....	402	27-192.....	383
21-SC-608.....	12	24-556.....	76	26-1436.....	402	27-193.....	383
21-SC-710.....	15	24-570.....	76	26-1627.....	406	27-194.....	383
21-SC-711.....	15	24-570XL.....	76	26-1628.....	406	27-195.....	383
21-SC-715.....	13	24-572.....	76	26-1629.....	406	27-196.....	383
21-SC-716.....	13	24-574.....	76	26-1630.....	406	27-197.....	383
21-SC-745.....	16	24-580.....	76	26-1632.....	406	27-198.....	383
22-480.....	289, 411	24-582.....	76	26-1634.....	406	27-199.....	383
22-481.....	411	24-1000.....	97	26-1636.....	406	27-200.....	383
22-482.....	411	24-1002.....	97	26-1638.....	406	27-201.....	175
22-484.....	411	25-28.....	401	26-1640.....	406	27-201.....	383
22-486.....	289	25-1240B.....	33	26-1650.....	407	27-202.....	384
22-488.....	289	25-362.....	50, 421	26-1652.....	407	27-204.....	384
22-490.....	289	25-378.....	50	26-1654.....	407	27-206.....	384
22-492.....	290	25-384.....	415	26-1656.....	407	27-208.....	384
22-494.....	290	25-385.....	415	26-1658.....	407	27-210.....	384
22-500TC.....	110, 131, 376, 381	25-390.....	416	26-1660.....	407	27-212.....	384
22-502TC.....	110, 131, 381	25-392.....	416	26-1728.....	405	27-213.....	142, 386
22-660.....	92	25-396.....	416	26-1729.....	405	27-214.....	142, 386
22-662.....	92	25-454.....	413	26-1730.....	405	27-215.....	142, 386
22-666.....	92	25-456.....	413	26-1731.....	405	27-216.....	142, 386
22-668.....	92	25-458.....	413	26-1732.....	405	27-217.....	142, 386
22-962.....	32	25-510.....	413	26-1733.....	405	27-218.....	142, 386
22D-420.....	411	25-511.....	413	26-1734.....	405	27-219.....	142, 386
22D-422.....	287	25-780.....	95	26-1735.....	405	27-224.....	142, 385
22D-424.....	288	25-782.....	95	26-1737.....	405	27-225.....	142, 385
22D-426.....	288	25-784.....	95	26-1738.....	405	27-230.....	157, 385
22D-428.....	288	25-786.....	95	26-1739.....	405	27-232.....	157, 385
22D-432.....	289	25-800.....	96	26-2000.....	385	27-260.....	394
23-399.....	185	25-812.....	89	26-2005.....	385	27-262.....	394
23-400.....	185	25-814.....	89	27-2.....	377	27-264.....	394
23-402.....	185	25-821.....	89	27-4.....	376, 377	27-270.....	388
23-410.....	185	25-834.....	89	27-6.....	377	27-272.....	388
23-420.....	185	25-835.....	89	27-7.....	376, 377	27-274.....	388
23-1048.....	155	25-836.....	90	27-14.....	377	27-280.....	394
23-1051.....	155	25-837.....	90	27-16.....	378	27-282.....	394
23-1139SS.....	186	25-838.....	90	27-20.....	378	27-331.....	388
23-1140SS.....	186	25-840.....	90	27-21.....	378	27-332.....	388
23-1142SS.....	186	25-848.....	90	27-22.....	378	27-333.....	388
23-1144SS.....	186	26-28.....	201	27-23.....	378	27-334.....	388
23-1146SS.....	186	26-30.....	201	27-24.....	379	27-335.....	388
23-1148SS.....	186	26-119.....	417	27-30.....	201, 379	27-336.....	388
23-1150SS.....	186	26-120.....	376, 417	27-32.....	379	27-418.....	395
23-1152SS.....	186	26-122.....	417	27-34.....	379	27-420.....	395
23-1154SS.....	186	26-124.....	417	27-42.....	379	27-422.....	395
23-1156SS.....	186	26-130.....	376, 417	27-44.....	379	27-424.....	395

27-426	395	27-603	376, 388	29-6-30	170	30-2530	359
27-426C	395	27-604	388	29-6-32	170	30-2535	359
27-427	395	27-605	388	29-6-34	170	30-2605	420
27-428	395	27-609	388	29-6-36	170	31-14	331
27-432	395	27-610	336, 388, 376	29-6-38	170	31-16	331
27-438	390	27-660	397	29-6-40	170	31-48	331
27-438C	390	27-662	397	29-14-8	170	31-49	331
27-440	390	27-700	163, 398	29-14-10	170	31-50	331
27-440C	390	27-702	163, 398	29-14-12	170	31-51	331
27-442	390	27-703	163, 398	29-14-14	170	31-70	330
27-442C	390	27-744	402	29-14-16	170	31-71	330
27-444	390	27-746	402	29-14-18	170	31-949	331
27-444C	390	27-747	403	29-14-20	170	31-951	331
27-446	390	27-748	403	29-14-22	170	31-952	331
27-446C	390	27-749	403	29-14-24	170	31-953	331
27-447	390	27-750	403	29-14-26	170	31-954	331
27-447C	390	27-752	403	29-14-28	170	31-965	330
27-448	390	27-753	403	29-14-30	170	31-1351	330
27-448C	390	27-754	403	29-14-32	170	31-1352	330
27-449	390	27-820	404	29-14-34	170	31-1353	330
27-449C	390	27-821	404	29-14-36	170	31-1354	330
27-450	390	27-822	404	29-32-8	169	31-1355	330
27-450C	390	27-824	404	29-32-10	169	31-5000	332
27-452	390	27-826	404	29-32-12	169	31-5002	332
27-452C	390	27-920	407	29-32-14	169	31-5022	332
27-458	395	27-924	407	29-32-16	169	31-5054	332
27-458C	395	27-926	407	29-32-18	169	31-5056	332
27-460	395	27-928	407	29-33-12	169	31-5070	332
27-460C	395	27-970	408	29-33-14	169	31-5072	332
27-462	395	27-972	408	29-33-16	169	31-5074	332
27-462C	395	27-974	408	29-33-18	169	31-5090	332
27-464C	395	27-980	408	29-33-20	169	31-5092	332
27-466	395	27-984	408	29-33-22	169	31-5094	332
27-466C	395	27-990	408	29-33-24	169	31-5096	332
27-468	395	27-992	408	29-33-26	169	31-5098	332
27-488	389	27-1000	33, 409	29-33-28	169	33-31	498
27-490	389	27-1016	409	29-33-30	169	33-31-P/25	498
27-492	389	27-1295	412	29-33-32	169	33-31A	498
27-494	389	27-1297	412	29-33-34	169	33-31A-P/25	498
27-496	389	27-1390	376, 416, 421	29-33-36	169	33-31AA	498
27-498	389	27-1392	416	29-33-38	169	33-31AA-P/25	498
27-499	389	27-1394	416	29-48	169	33-31B	498
27-500	389	27-1400	416	29-280	89	33-32	498
27-502	389	27-1402	416	29-282	89	33-32-P/25	498
27-504	389	27-1404	416	29-310TC	111	33-33	498
27-506	389	27-1550	418	30-10	180, 359	33-33-SH	498
27-508	389	27-1560	418	30-50	180	33-34	498
27-510	389	27-1561	418	30-62	180	33-34-P/25	498
27-512	389	27-1564	418	30-1025	96	33-34-SH	498
27-514	389	27-1564-12	418	30-1030	96	33-35	498
27-516	389	27-1564-18	418	30-1050-10	96	33-35-SH	498
27-518	389	27-3060	51	30-1050-6	96	33-36	498
27-520	389	27-3070	51	30-1050-8	96	33-36-SH	498
27-522	389	27-3100	51	30-1700	88	33-37	498
27-530	389	28-100	166	30-1710	88	33-38	498
27-532	389	28-104	355	30-1715	88	33-52	499
27-534	389	28-106	167	30-1716	88	33-53	499
27-536	389	28-108	167, 355	30-1718	88, 359	33-54	499
27-538	389	28-109	167	30-1720	88	33-55	499
27-540	389	28-131	157	30-1730	88, 359	33-57	499
27-542	389	28-370	189	30-1735	88	33-100	499
27-549	395	29-2	170	30-1740	88	33-140	45
27-550	395	29-4	170	30-1805	98	33-142	45
27-551	395	29-6-8	170	30-1815	98, 359	33-240	33
27-553	395	29-6-10	170	30-2101TC	17	33-242	33
27-554	395	29-6-12	170	30-2102TC	17	33-500	76
27-556	395	29-6-14	170	30-2103TC	17	34-50	420
27-558	395	29-6-16	170	30-2105TC	17	34-52	420
27-599	388	29-6-18	170	30-2106TC	17	34-80	420
27-600	388	29-6-20	170	30-2107TC	17	34-92	27, 420
27-601	388	29-6-22	170	30-2109TC	17	34-98	33, 420
27-601A	388	29-6-24	170	30-2110TC	17	34-210	421
27-602	388	29-6-26	170	30-2111TC	17	34-220	421
27-602A	388	29-6-28	170	30-2505	102, 357	34-250	421

34-256	421	63-15	181, 228	70-730R	241	75-44	220
40-245-SS	193	63-15A	181, 228	70-732	240	75-45	220
40-250-SS	193	63-20	181, 228	70-732R	241	75-46	220
40-251-SS	193	63-20A	181, 228	70-734	240	75-48	219
40-252	193	65-25	527	70-734R	241	76-1	221
40-425	45	65-28	528, 523	70-736	240	76-3	221
40-435	45	65-29	523	70-736R	241	76-5	355
40-445	45	66-49	292	70-738	240	76-40	196
40-460	33	66-311	292	70-738R	241	76-42	196
40-1235	151	66-312A	292	70-739	240	76-43	196, 258
40-1370	164, 281, 400	66-317	292	70-739R	241	76-70	196, 258
40-1371	164, 281, 400	66-317A	292	70-740	240	77-70	196, 258
40-1375	164, 281, 400	66-317B	292	70-740R	241	80-5000	238
40-1380	164, 282, 400	66-317S	292	70-741	240	80-5002	238
40-1381	164, 282, 400	66-318	292	70-741R	241	80-5005	239
40-1382	164, 282, 400	66-318-49	292	70-742	240	80-5006	239
40-1385	164, 282, 400	66-652	292	70-742R	241	80-5007	239
40-1800	409	66-656	292	70-743	240	80-5101	240
40-1802	409	66-660	291 313	70-743R	241	80-5102	240
40-2800	164, 282, 400	67-664/3	253	70-745	240	80-5103	240
40-2801	282	67-664/4	253	70-745R	241	80-5104	240
40-2802	282	67-664/5	253	70-766	248	80-5105	240
61-2	269	67-668/3	253	70-799	248	80-5106	240
61-4	269	67-668/4	253	70-2000	250	80-5107	240
61-6	269	67-668/5	253	71-35	227	80-5108	240
61-8	269	67-672/3	253	71-62	229	80-5109	240
61-10	269	67-672/4	253	71-62TC	229	80-5110	242
61-12	269	67-672/5	253	71-63	229	80-5111	242
61-14	269	67-676/4	253	71-64	229	80-5112	242
61-16	269	67-676/5	253	71-64TC	229	80-5113	242
61-18	269	67-696/3	252	71-65	229	80-5114	242
61-20	269	67-696/3	235, 342	71-66	229	80-5115	242
62-2	283	67-696/4	235, 252, 342	71-66TC	229	80-5116	242
62-4	283	67-696/5	252	71-67	229	80-5119	244
62-6	283	67-698/3	252	71-68	229	80-5120	244
62-8	283	67-698/4	252	71-68TC	229	80-5121	244
62-20	284, 393	67-698/5	252	71-69	229	80-5122	244
62-21	284, 393	67-700/4	255	71-96	231	80-5123	244
62-22	284, 393	67-700/5	255	72-60	222	80-5124	244
62-23	284, 393	67-710/4	255	72-62	222	80-5125	244
62-40	284, 393	67-710/5	255	72-70	222	80-5126	244
62-41	284, 393	67-719	254	73-24	207	80-5127	244
62-42	284, 393	67-720	254	73-26	207	80-5152	252
62-43	284, 393	68-693	223	73-28	207	80-5203	246
62-44	284, 393	68-694	223	73-30	207	80-5204	246
62-45	284, 393	68-695	223	73-32	207	80-5205	246
62-100	285, 391	68-696	223	73-34	207	80-5301	237
62-101	285, 391	68-697	223	73-36	207	80-5302	236
62-102	285, 391	70-4	199	73-38	207	80-5303	237
62-103	285, 391	70-6	199	73-46	207	80-5400	236
62-104	285, 391	70-8	199	73-58	208	80-5401	236
62-105	285, 391	70-14	199	73-62	208, 404	80-5450	252
62-106	285, 391	70-16	199	73-64	208, 257, 268,	80-6002	204
62-120	285, 391	70-18	199		338, 404	80-6004	204
62-121	285, 391	70-20	199	73-66	404	80-6005	204
62-122	285, 391	70-108	238	73-68	208	80-6006	204
62-123	285, 391	70-110	238	73-70	208	80-6009	204
62-124	285, 391	70-116	238	73-72	208	80-6012	204
62-125	285, 391	70-144	283	73-76	208	80-6034	204
62-180	286	70-146	283	73-78	208, 404	80-6200	201
62-181	286	70-148	283	75-12	220	80-6203	201
62-182	286	70-150	283	75-14	220	80-6300	199
62-183	286	70-153	293	75-15	220	80-6302	199
62-184	286	70-170	259, 335	75-16	220	80-6303	199
62-185	286	70-171	259, 335	75-20	249	80-6304	199
62-190	286	70-172	259, 335	75-22	249	80-6307	199
62-191	286	70-177	259, 335	75-24	249	80-6400	202
62-192	286	70-204	204	75-26	249	80-6401	202
62-200	294	70-206	204	75-28	249	80-6402	202
62-201	294	70-212	204	75-30	249	80-6403	202
62-202	294	70-213	204	75-38	220	80-6404	202
63-10	181, 228	70-214	204	75-38A	220	80-6405	202
63-10A	181, 228	70-730	240	75-40	220	80-6406	202

80-6407	202	620-81250	222	838/010	216	4611	501
80-6408	202	620-81270	222	838/012	216	4615	501
80-6500	230	620-81290	222	838/014	216	5703	49
80-6501	230	620-81310	222	838/016	216	5704	49
80-6503	230	630-81330	222	838G014	216	5705	49
80-6504	230	630-81350	222	839/010	214	5801	49
80-6600	208	630-81370	222	845/010	216	5802	49
80-6601	200	630-81390	222	845/012	216	5803	49
80-6602	208	630-81410	222	845/014	216	5804	49
106-55590	224	630-81430	222	846/014	216	6000-SS	425
107-55710	224	630-81450	222	846/016	216	6001-CH	425
110-56270	224	630-81470	222	846/018	216	6001-SS	425
110-56290	224	630-81490	222	846G016	216	6003-CH	425
116-56450	224	630-81510	222	847/016	216	6003-SS	425
116-56510	224	630-81530	222	847/018	216	6004	425
116-56570	224	630-81550	222	847G018	216	6006	425
116-56630	224	630-81570	222	848/016	217	6008	424, 425
117-56470	224	630-81590	222	848/018	217	6035	191
117-56530	224	630-81610	222	848G018	217	6039	181, 228
117-56590	224	630-81630	222	849/010	217	6040	181, 228
117-56650	224	699.504.008	218	849/014	217	6041	181, 228
120-57130	225	699.514.008	218	849/016	217	6042	181, 228
120-57150	225	801/009	214	849G016	217	6043	181, 228
125-57250	225	801/010	214	850/012	217	6043	181, 228
140-57510	225	801/014	214	850/016	217	6051	280
140-57550	225	801/016	214	850/018	217	6052	280
140-57590	225	801/018	214	850G018	217	6081	290
140-57630	225	801G014	214	851/015	217	6300	194
159.504.010	218	802/009	214	852/011	217	6301	194
159.514.010	218	802/010	214	852/014	217	6302	194
165.504.014	218	802/012	214	852/016	217	6501	197
165.514.014	218	802/014	214	852/018	217	6600	181, 228
166.504.014	218	802/016	214	852G018	217	6601	181, 228
166.514.014	218	802/018	214	853/014	217	6800	335
195.504.009	218	802G014	214	853/016	217	6806	338
195.514.009	218	805/010	215	860/009	217	6809	342
277.504.023	218	805/012	215	860/010	217	6810	334, 424
277.514.023	218	805/016	215	861/012	217	6820	334, 424
404-40413	222	805/018	215	862/012	217	6830	337, 362
404-40414	222	805G015	215	862/014	217	6840	336, 376
558-25871	226	805G018	215	862/016	217	6890	337, 344
558-25875	226	806/010	215	863/012	217	6890-NC	337, 344
558-25890	226	806/012	215	863/016	217	15050	179
560-26490	513	806/014	215	863/018	217	15051	179
560-26510	513	806/016	215	863G018	217	15052	179
560-26530	513	806/018	215	867/010	218	15053	179
560-26550	513	806G012	215	867/012	218	15054	179
560-26570	513	806G016	215	868/012	218	15055	179
560-26590	513	807/016	215	868/014	218	33510	341
560-26610	513	807G016	215	868G014	218	33511	341
568-70690	249	808/010	214	869/012	218	33512	341
568-70750	249	808/012	214	869/014	218	33513	341
568-70810	249	808/014	214	869G014	218	33514	341
568-70870	249	818/014	215	870/010	218	33516	341
569-70830	249	818/018	215	870/012	218	33517	341
569-70850	249	818/035	215	870/014	218	33519	341
570-70710	249	818/047	215	870/018	218	33520	341
570-70770	249	819/018	215	879/018	218	374201	502
570-70890	249	825/042	214	884/012	218	374202	502
571-70730	249	831/018	214	885/012	218	41900	502
571-70790	249	832/018	214	886/014	218	41901	502
571-70910	249	835/008	216	887/016	218	41902	502
620-81010	222	835/009	216	909/035	215	41903	502
620-81030	222	835/010	216	909G035	215	405043	502
620-81050	222	835/012	216	914/220	219	600900	502
620-81070	222	835/014	216	915/220	219	AW	231
620-81090	222	835G012	216	1700	45, 320	DEF6	278
620-81110	222	835G014	216	1702	45, 320	DEF13	274
620-81130	222	836/012	216	1704	45, 320	DEF16	277
620-81150	222	836/014	216	1706	45	DEF16S	276
620-81170	222	837/014	216	1718-SS	45, 193	DEF17	277
620-81190	222	837/016	216	1720	45, 193	DEF17S	273
620-81210	222	837/018	216	1721	193	DEF17TC	279
620-81230	222	837G018	216	4610	501	DEF22	274
						DEF23	277

DEF23S.....	273	DEL78.....	267	DFG169L.....	211	DFG7612-5.....	213
DEF33.....	274	DEL79.....	267	DFG170.....	211	DFG7613-5.....	213
DEF101.....	278	DEL7X.....	266	DFG170L.....	211	DFG7702-5.....	213
DEF10S.....	277	DEL80.....	267	DFG171.....	211	DFG7713-5.....	213
DEF116.....	278	DEL81.....	264	DFG171L.....	211	DFG7801-5.....	213
DEF120.....	278	DELA.....	264	DFG172.....	211	DFG7802-5.....	213
DEF150.....	278	DELH1.....	267	DFG245.....	211	DFG7901-5.....	213
DEF150 1/2S.....	273	DELH2.....	267	DFG245-CL.....	212	DFG7902-5.....	213
DEF150A.....	278	DELH2-3.....	267	DFG2SU.....	210	DFG7903-5.....	213
DEF150AS.....	278	DELH3.....	267	DFG329.....	211	DHF21/10.....	303
DEF150S.....	276	DELLUXC2.....	260, 261, 340	DFG330.....	211	DHF21/15.....	303
DEF150STC.....	279	DELLUXC3.....	257, 260, 261	DFG330-CL.....	212	DHF21/15-40.....	303
DEF150TC.....	279	338, 340	DFG331.....	211	DHF21/20.....	303
DEF150XAS.....	276	DELLUXC4.....	260, 261, 340	DFG331-CL.....	212	DHF21/25.....	303
DEF151.....	278	DELLUXC5.....	257, 260, 261	DFG331/2.....	212	DHF21/30.....	303
DEF151 1/2S.....	273	338, 340	DFG331/2-CL.....	212	DHF21/35.....	303
DEF151A.....	278	DELLUXKIT.....	340	DFG332.....	211	DHF21/40.....	303
DEF151AS.....	278	DELLUXS2.....	257, 260, 261	DFG556.....	210	DHF25/10.....	303
DEF151S.....	276	338, 340	DFG556-CL.....	212	DHF25/15.....	303
DEF151STC.....	279	DELLUXS3.....	257, 260, 261	DFG557.....	210	DHF25/15-40.....	303
DEF151TC.....	279	338, 340	DFG557-CL.....	212	DHF25/20.....	303
DEF151XAS.....	276	DELLUXS4.....	260, 261, 340	DFG557L.....	210	DHF25/25.....	303
DEF1STD.....	278	DELLUXS5.....	257, 260, 261	DFG557SU.....	210	DHF25/30.....	303
DEF1STDT.....	279	338, 340	DFG558.....	210	DHF25/35.....	303
DEF210S.....	277	DELM9.....	268	DFG558-CL.....	212	DHF25/40.....	303
DEF53LTC.....	279	DELOHL.....	268	DFG558L.....	210	DHF25/45.....	303
DEF62.....	278	DELPR3.....	268	DFG558SU.....	210	DHF25/45-80.....	303
DEF69.....	278	DELS23.....	268, 404	DFG559.....	210	DHF25/50.....	303
DEF73.....	274	DELW2.....	268	DFG559SU.....	210	DHF25/55.....	303
DEF74.....	274	DELWNG2.....	262, 263, 339	DFG560.....	210	DHF25/60.....	303
DEF74N.....	274	DELWNG3.....	262, 263, 339	DFG699.....	210	DHF25/70.....	303
DEF85A.....	277	DELWNG4.....	262, 263, 339	DFG699L.....	210	DHF25/80.....	303
DEF88L.....	277	DELWNG5.....	262, 263, 339	DFG6SU.....	210	DHP1.....	210
DEFA.....	273	DELWNG6.....	262, 263, 339	DFG700.....	210	DHP1/2.....	210
DEFB.....	273	DELWNG7.....	262, 263, 339	DFG700-CL.....	212	DHP1/4.....	210
DEFC.....	273	DELWNG8.....	262, 263, 339	DFG700L.....	210	DHP2.....	210
DEFDGI50.....	271	DFG1.....	210	DFG700SU.....	210	DHP3.....	210
DEFDGI50A.....	271	DFG1/2.....	210	DFG701.....	210	DHP4.....	210
DEFDGI51.....	271	DFG1/2-CL.....	212	DFG701-CL.....	212	DHP5.....	210
DEFDGI51STD.....	271	DFG1/2SU.....	210	DFG701L.....	210	DHP6.....	210
DEFDGI51SU.....	271	DFG1/4.....	210	DFG701SU.....	210	DHP7.....	210
DEFDGI51SU-CL.....	212	DFG1/4-CL.....	212	DFG702.....	210	DHP8.....	210
DEFDGI51SU-CL-CL.....	212	DFG2.....	210	DFG702SU.....	210	DHP10.....	210
DEFDGI51SU-CL-CL-CL.....	212	DFG2-CL.....	212	DFG703.....	210	DHP331/2.....	212
DEFDGI51SU-CL-CL-CL-CL.....	212	DFG3.....	210	DFG703SU.....	210	DHP34.....	212
DEFDGI51SU-CL-CL-CL-CL-CL.....	212	DFG4.....	210	DFG957.....	211	DHP35.....	212
DEFDGI51SU-CL-CL-CL-CL-CL-CL.....	212	DFG4-CL.....	212	DFG958.....	211	DHP36.....	212
DEFDGI51SU-CL-CL-CL-CL-CL-CL-CL.....	212	DFG4SU.....	210	DFG1156.....	211	DHP37.....	212
DEFDGI51SU-CL-CL-CL-CL-CL-CL-CL-CL.....	212	DFG5.....	210	DFG1157.....	211	DHP38.....	212
DEFDGI51SU-CL-CL-CL-CL-CL-CL-CL-CL-CL.....	212	DFG6.....	210	DFG1157-CL.....	212	DHP39.....	212
DEFDGI51SU-CL-CL-CL-CL-CL-CL-CL-CL-CL-CL.....	212	DFG6-CL.....	212	DFG1158.....	211	DHP556.....	210
DEFDGI51SU-CL-CL-CL-CL-CL-CL-CL-CL-CL-CL-CL.....	212	DFG7.....	210	DFG1159.....	211	DHP557.....	210
DEFDGI51SU-CL-CL-CL-CL-CL-CL-CL-CL-CL-CL-CL-CL.....	212	DFG8.....	210	DFG1170.....	211	DHP558.....	210
DEFDGI51SU-CL-CL-CL-CL-CL-CL-CL-CL-CL-CL-CL-CL-CL.....	212	DFG8-CL.....	212	DFG1171.....	211	DHP559.....	210
DEFDGI51SU-CL-CL-CL-CL-CL-CL-CL-CL-CL-CL-CL-CL-CL-CL.....	212	DFG8SU.....	210	DFG1557.....	211	DHP560.....	210
DEFDGI51SU-CL-CL-CL-CL-CL-CL-CL-CL-CL-CL-CL-CL-CL-CL-CL.....	212	DFG14.....	211	DFG1557-CL.....	212	DHP699.....	210
DEFDGI51SU-CL-CL-CL-CL-CL-CL-CL-CL-CL-CL-CL-CL-CL-CL-CL-CL.....	212	DFG34.....	212	DFG1558.....	211	DHP700.....	210
DEFDGI51SU-CL-CL-CL-CL-CL-CL-CL-CL-CL-CL-CL-CL-CL-CL-CL-CL-CL.....	212	DFG34-CL.....	212	DFG1558-CL.....	212	DHP701.....	210
DEFDGI51SU-CL-CL-CL-CL-CL-CL-CL-CL-CL-CL-CL-CL-CL-CL-CL-CL-CL-CL.....	212	DFG35.....	212	DFG1558SU.....	211	DHP702.....	210
DEFDGI51SU-CL-CL-CL-CL-CL-CL-CL-CL-CL-CL-CL-CL-CL-CL-CL-CL-CL-CL-CL.....	212	DFG35-CL.....	212	DFG1559.....	211	DHP703.....	210
DEFDGI51SU-CL.....	212	DFG36.....	212	DFG1931-5.....	213	DHP1557.....	211
DEFDGI51SU-CL.....	212	DFG37.....	212	DFG1958-5.....	213	DHP1558.....	211
DEFDGI51SU-CL.....	212	DFG38.....	212	DFG7006-5.....	213	DKF21/06.....	303
DEFDGI51SU-CL.....	212	DFG39.....	212	DFG7104-5.....	213	DKF21/08.....	303
DEFDGI51SU-CL.....	212	DFG56.....	211	DFG7106-5.....	213	DKF21/10.....	303
DEFDGI51SU-CL.....	212	DFG56-CL.....	212	DFG7108-5.....	213	DKF21/15.....	303
DEFDGI51SU-CL.....	212	DFG57.....	211	DFG7204-5.....	213	DKF21/15-40.....	303
DEFDGI51SU-CL.....	212	DFG57-CL.....	212	DFG7205-5.....	213	DKF21/20.....	303
DEFDGI51SU-CL.....	212	DFG57L.....	211	DFG7404-5.....	213	DKF21/25.....	303
DEFDGI51SU-CL.....	212	DFG58.....	211	DFG7406-5.....	213	DKF21/30.....	303
DEFDGI51SU-CL.....	212	DFG58L.....	211	DFG7408-5.....	213	DKF21/35.....	303
DEFDGI51SU-CL.....	212	DFG59.....	211	DFG7606-5.....	213	DKF21/40.....	303
DEFDGI51SU-CL.....	212	DFG60.....	211	DFG7610-5.....	213	DKF21/45.....	303
DEFDGI51SU-CL.....	212	DFG169.....	211	DFG7611-5.....	213	DKF21/45-80.....	303

DKF21/50.....	303	DR25/40.....	305	MH5-26.....	434	MH6-121.....	443
DKF21/55.....	303	DR25/45.....	305	MH5-36.....	434	MH6-122.....	443
DKF21/60.....	303	DR25/45-80.....	305	MH5-46.....	434	MH6-123.....	443
DKF21/70.....	303	DR25/50.....	305	MH5-56.....	434	MH6-124.....	428, 443
DKF21/80.....	303	DR25/55.....	305	MH5-120.....	432	MH6-142.....	444
DKF25/06.....	303	DR25/60.....	305	MH5-120TC.....	429	MH6-144.....	444
DKF25/08.....	303	DR25/70.....	305	MH5-122.....	432	MH6-145.....	444
DKF25/10.....	303	DR25/80.....	305	MH5-122TC.....	429	MH6-148.....	444
DKF25/15.....	303	DRA1.....	210	MH5-124.....	428, 432	MH6-150.....	444
DKF25/15-40.....	303	DRA1/2.....	210	MH5-124TC.....	429	MH6-154.....	444
DKF25/20.....	303	DRA2.....	210	MH5-126.....	432	MH6-154TC.....	444
DKF25/25.....	303	DRA3.....	210	MH5-126TC.....	429	MH6-160.....	444
DKF25/30.....	303	DRA331/2.....	212	MH5-128.....	432	MH6-180.....	445
DKF25/35.....	303	DRA34.....	212	MH5-128TC.....	429	MH6-182.....	445
DKF25/40.....	303	DRA35.....	212	MH5-130.....	432	MH6-182.....	445
DKF25/45.....	303	DRA36.....	212	MH5-130TC.....	429	MH6-190.....	445
DKF25/45-80.....	303	DRA37.....	212	MH5-179.....	433	MH6-192.....	445
DKF25/50.....	303	DRA38.....	212	MH5-179TC.....	430	MH6-196.....	445
DKF25/55.....	303	DRA39.....	212	MH5-180.....	433	MH6-197.....	445
DKF25/60.....	303	DRA4.....	210	MH5-180TC.....	430	MH6-198.....	445
DKF25/70.....	303	DRA5.....	210	MH5-181.....	433	MH6-214.....	445
DKF25/80.....	303	DRA556.....	210	MH5-182.....	428, 433	MH6-300.....	448
DKF31/06.....	303	DRA557.....	210	MH5-182A-TC.....	430	MH6-304.....	448
DKF31/08.....	303	DRA558.....	210	MH5-182TC.....	430	MH6-316.....	448
DKF31/10.....	303	DRA559.....	210	MH5-264.....	438	MH6-318.....	448
DKF31/15.....	303	DRA6.....	210	MH5-264.....	438	MH6-400.....	448
DKF31/15-40.....	303	DRA699.....	210	MH5-270.....	435	MH7-2.....	451
DKF31/20.....	303	DRA7.....	210	MH5-272.....	435	MH7-4.....	428, 451
DKF31/25.....	303	DRA700.....	210	MH5-274.....	435	MH7-8.....	451
DKF31/30.....	303	DRA701.....	210	MH5-276.....	435	MH7-10.....	451
DKF31/35.....	303	DRA702.....	210	MH5-278.....	435	MH7-10.....	451
DKF31/40.....	303	DRA703.....	210	MH5-280.....	435	MH7-24.....	451
DKF31/45.....	303	DRA8.....	210	MH5-288.....	433	MH7-26.....	451
DKF31/45-80.....	303	DTS.....	512	MH5-288.....	433	MH7-36.....	428, 451
DKF31/50.....	303	DTST.....	235, 342, 512	MH5-300.....	437	MH7-38.....	428, 451
DKF31/55.....	303	EE2.....	237	MH5-302.....	437	MH7-42.....	451
DKF31/60.....	303	EE5.....	237	MH5-304.....	437	MH7-44.....	451
DKF31/70.....	303	EE6.....	237	MH5-304TC.....	431	MH7-46.....	451
DKF31/80.....	303	EE16.....	237	MH5-306.....	437	MH7-48.....	451
DP1020.....	251	EE423.....	236	MH5-306TC.....	431	MH7-50.....	451
DP1030-3.....	251	EE1112.....	237	MH5-312.....	438	MH7-52.....	451
DP1520.....	251	EE1523.....	236	MH5-312TC.....	431	MH7-66.....	451
DP5000.....	251	EE1723.....	237	MH5-314.....	438	MH7-68.....	451
DP5030.....	251	EE0W23.....	236	MH5-314TC.....	431	MH7-92.....	451
DP5070.....	251	EM-2151.....	179	MH5-512.....	441	MH7-94.....	451
DP5150.....	251	EM-2151LS.....	179	MH5-514.....	441	MH7-102.....	452
DP5200.....	251	EM-2155.....	179	MH5-516.....	441	MH7-106.....	452
DP5250.....	251	GC61.....	218	MH5-550.....	441	MH7-118.....	452
DP5400.....	251	GC62.....	218	MH5-560.....	441	MH7-120.....	452
DR21/08.....	305	GC81.....	218	MH5-568.....	441	MH7-122.....	452
DR21/10.....	305	GC82.....	218	MH5-SC-120.....	429	MH7-124.....	452
DR21/15.....	305	GC83.....	218	MH5-SC-122.....	429	MH7-126.....	452
DR21/15-40.....	305	GC84.....	218	MH5-SC-124.....	429	MH7-136.....	452
DR21/20.....	305	GC101.....	218	MH5-SC-126.....	429	MH7-138.....	452
DR21/25.....	305	GC102.....	218	MH5-SC-128.....	429	MH7-140.....	452
DR21/30.....	305	GC104.....	218	MH5-SC-130.....	429	MH7-142.....	452
DR21/35.....	305	MH2-104SS.....	477	MH5-SC-180.....	430	MH7-144.....	452
DR21/40.....	305	MH2-106SS.....	477	MH5-SC-182.....	430	MH7-144.....	452
DR21/45.....	305	MH2-109.....	477	MH5-SC-304.....	431	MH7-150.....	453
DR21/45-80.....	305	MH2-110SS.....	477	MH5-SC-306.....	431	MH7-152.....	453
DR21/50.....	305	MH4-10.....	486	MH6-4.....	443	MH7-154.....	453
DR21/55.....	305	MH4-7.....	428, 486	MH6-6.....	443	MH7-160.....	453
DR21/60.....	305	MH4-8.....	486	MH6-8.....	443	MH7-162.....	453
DR21/70.....	305	MH4-9.....	486	MH6-10.....	443	MH7-164.....	453
DR21/80.....	305	MH5-2.....	434	MH6-14.....	443	MH7-170.....	453
DR24/45-80.....	305	MH5-4.....	434	MH6-40.....	443	MH7-172.....	428, 453
DR25/08.....	305	MH5-6.....	434	MH6-42.....	443	MH7-180.....	453
DR25/10.....	305	MH5-8.....	434	MH6-44.....	428	MH7-182.....	453
DR25/15.....	305	MH5-12.....	434	MH6-46.....	443	MH7-202.....	453
DR25/15-40.....	305	MH5-14.....	434	MH6-48.....	443	MH7-206.....	453
DR25/20.....	305	MH5-16.....	434	MH6-104.....	443	MH7-220.....	453
DR25/25.....	305	MH5-18.....	434	MH6-106.....	443	MH7-221.....	453
DR25/30.....	305	MH5-22.....	434	MH6-118.....	443	MH7-240.....	453
DR25/35.....	305	MH5-24.....	434	MH6-118TC.....	443	MH7-242.....	453
				MH6-120.....	443	MH7-255.....	454
						MH7-256.....	454
						MH7-257.....	454

MH7-258.....	454	MH11-114.....	466	MH16-48.....	450	MH19-290.....	478
MH7-259.....	454	MH11-120.....	466	MH16-51.....	450	MH19-292.....	478
MH7-504.....	428, 456	MH11-122.....	466	MH16-160.....	454	MH19-294.....	478
MH7-506.....	428, 456	MH11-132.....	466	MH16-162.....	454	MH19-296.....	478
MH7-514.....	456	MH11-136.....	466	MH17-2500.....	444	MH19-298.....	478
MH7-515.....	456	MH11-140.....	466	MH17-2510.....	444	MH19-314.....	478
MH7-516.....	456	MH11-144.....	466	MH17-2600.....	454	MH19-316.....	478
MH7-600.....	456	MH11-146.....	466	MH17-2602.....	454	MH19-318.....	478
MH7-602.....	456	MH11-162.....	466	MH18-35.....	473	MH19-350.....	447
MH7-604.....	456	MH11-164.....	466	MH18-36.....	473	MH19-370.....	447
MH7-610.....	456	MH11-166.....	466	MH18-100.....	471	MH19-410.....	464
MH7-614.....	456	MH11-180.....	467	MH18-102.....	471	MH19-411.....	464
MH7-622.....	456	MH11-182.....	467	MH18-110.....	471	MH19-434.....	464
MH8-2.....	460	MH11-184.....	467	MH18-112.....	471	MH19-570.....	477
MH8-4.....	460	MH11-185.....	467	MH18-114.....	471	MH19-572.....	477
MH8-4TC.....	457	MH11-202.....	467	MH18-116.....	471	MH19-573.....	477
MH8-6.....	460	MH11-206.....	467	MH18-412.....	474	MH19-574.....	477
MH8-6TC.....	457	MH11-208.....	467	MH18-414.....	474	MH19-575.....	477
MH8-8.....	460	MH11-210.....	467	MH18-416.....	474	MH19-576.....	477
MH8-8A-TC.....	457	MH11-219.....	467	MH18-440.....	474	MH19-577.....	477
MH8-14.....	460	MH11-220.....	467	MH18-446.....	474	MH19-580.....	477
MH8-15.....	460	MH11-240.....	467	MH18-450.....	474	MH19-582.....	477
MH8-15TC.....	457	MH11-242.....	467	MH18-452.....	474	MH19-584.....	477
MH8-16.....	460	MH11-244.....	467	MH18-454.....	474	MH19-700.....	479
MH8-16TC.....	457	MH11-246.....	468	MH18-780.....	446	MH19-702.....	479
MH8-17.....	460	MH11-247.....	468	MH18-782.....	446	MH19-704.....	479
MH8-17TC.....	457	MH11-248.....	468	MH18-784.....	446	MH19-706.....	479
MH8-20.....	460	MH11-249.....	468	MH18-786.....	446	MH19-708.....	479
MH8-22.....	460	MH11-260.....	468	MH18-788.....	446	MH19-710.....	479
MH8-40.....	461	MH11-260-A.....	468	MH18-790.....	446	MH19-712.....	479
MH8-40TC.....	458	MH11-260-B.....	468	MH18-835.....	446	MH19-714.....	479
MH8-42.....	461	MH11-266.....	468	MH18-836.....	446	MH19-716.....	479
MH8-42TC.....	458	MH11-268.....	468	MH18-866.....	446	MH19-718.....	479
MH8-44.....	461	MH11-269.....	468	MH18-867.....	446	MH19-720.....	479
MH8-44TC.....	458	MH11-314.....	468	MH18-868.....	446	MH19-793.....	481
MH8-46.....	461	MH11-316.....	468	MH18-948.....	447	MH19-796.....	481
MH8-46TC.....	458	MH11-364.....	148, 470	MH18-949.....	447	MH19-844.....	480
MH8-48.....	461	MH11-365.....	470	MH18-954.....	447	MH19-848.....	480
MH8-48TC.....	458	MH11-366.....	470	MH18-955.....	447	MH19-849.....	480
MH8-50.....	461	MH11-530.....	469	MH18-1396.....	437	MH19-850.....	480
MH8-50TC.....	458	MH11-532.....	469	MH18-1398.....	437	MH19-852.....	480
MH8-51.....	461	MH11-534.....	469	MH18-1415.....	437	MH19-1230.....	480
MH8-51TC.....	458	MH11-536.....	469	MH18-1416.....	437	MH19-1232.....	480
MH8-52.....	461	MH11-538.....	469	MH18-1417.....	437	MH19-2081.....	464
MH8-52TC.....	458	MH11-540.....	469	MH18-1418.....	437	MH19-2110.....	464
MH8-100.....	462	MH11-542.....	469	MH18-1420.....	438	MH20-2.....	473
MH8-100TC.....	459	MH11-544.....	469	MH18-1422.....	438	MH20-3.....	473
MH8-101TC.....	459	MH11-580.....	469	MH18-1426.....	438	MH20-4.....	473
MH8-103TC.....	459	MH11-582.....	469	MH18-1428.....	438	MH20-12.....	473
MH8-104TC.....	459	MH11-590.....	469	MH18-1460.....	439	MH20-24.....	473
MH8-105TC.....	459	MH11-600.....	470	MH18-1462.....	439	MH20-28.....	473
MH8-130.....	462	MH11-602.....	470	MH18-1464.....	439	MH20-29.....	473
MH8-130TC.....	459	MH11-608.....	470	MH18-1466.....	439	MH20-30.....	473
MH9-98.....	436	MH11-610.....	470	MH18-1472.....	439	MH20-32.....	473
MH9-100.....	436	MH11-614.....	470	MH18-1476.....	439	MH20-140.....	464
MH9-102.....	436	MH11-616.....	470	MH18-1486.....	436	MH20-142.....	464
MH9-104.....	436	MH11-630-BL.....	470	MH18-1572.....	439	MH21-60.....	484
MH9-110.....	436	MH11-630-SH.....	470	MH18-1576.....	439	MH21-64.....	484
MH9-124.....	442	MH11-684.....	470	MH18-1578.....	439	MH21-72.....	484
MH9-124TC.....	442	MH11-700.....	470	MH18-1620.....	439	MH21-88.....	474
MH10-310.....	477	MH11-702.....	470	MH18-1622.....	439	MH21-89.....	474
MH10-312.....	477	MH12-80.....	450	MH18-1652.....	439	MH21-90.....	474
MH11-2.....	465	MH14-48.....	454	MH18-1653.....	439	MH21-92.....	474
MH11-12.....	465	MH16-4.....	449	MH18-1828.....	462	MH21-94.....	474
MH11-13.....	465	MH16-6.....	428, 449	MH18-1828TC.....	459	MH21-144.....	475
MH11-14.....	465	MH16-8.....	449	MH18-1832.....	462	MH21-145.....	471, 475
MH11-16.....	465	MH16-10.....	449	MH18-1968.....	484	MH21-146.....	471, 475
MH11-22.....	465	MH16-12.....	449	MH19-220.....	474	MH21-148.....	471
MH11-73.....	465	MH16-30.....	449	MH19-222.....	474	MH21-152.....	475
MH11-74.....	465	MH16-31.....	449	MH19-280.....	478	MH21-153.....	475
MH11-76.....	465	MH16-38.....	449	MH19-282.....	478	MH21-154.....	475
MH11-78.....	465	MH16-42.....	450	MH19-284.....	478	MH21-156.....	475
MH11-102.....	466	MH16-44.....	450	MH19-286.....	478	MH21-158.....	475
MH11-110.....	466	MH16-46.....	450	MH19-288.....	478	MH21-160.....	475

MH21-165.....	471	MH27-34.....	463	MS-153.....	134	PM-044408.....	392
MH21-188.....	471	MH27-160.....	442	MS-155.....	135	PM-044410.....	392
MH21-205-2.....	482	MH27-213.....	472	MS-156.....	135	PM-044412.....	392
MH21-205-4.....	482	MH27-214.....	472	MS-172.....	135	PM-044422.....	392
MH21-205-6.....	482	MH27-215.....	472	MS-175.....	135	PM-044424.....	392
MH21-205-8.....	482	MH27-216.....	472	MS-176.....	135	PM-044426.....	392
MH21-205-10.....	482	MH27-217.....	472	MS-177.....	135	PM-044428.....	392
MH21-205-12.....	482	MH27-218.....	472	MS-179.....	134	PM-044430.....	392
MH21-206-4.....	482	MH27-219.....	472	MS-192.....	134	PM-044432.....	392
MH21-206-7.....	482	MH27-438.....	482	MS-192A.....	134	SP2.....	512
MH21-206-9.....	482	MH27-438C.....	482	MS-192S.....	134	SPC.....	512
MH21-206-12.....	482	MH27-440.....	482	MS-431.....	134	SPF.....	512
MH21-232.....	482	MH27-440C.....	482	MS-450.....	134	SPM.....	512
MH21-233.....	482	MH27-442.....	482	MS-1274.....	135	STD222.....	522
MH21-234.....	482	MH27-442C.....	482	MS-1281.....	135	STD1515.....	525
MH21-330.....	476	MH27-444.....	483	MS-1282.....	135	STD2020.....	525
MH21-338.....	476	MH27-444C.....	483	MS-1291.....	135	STD2424.....	525
MH21-342.....	476	MH27-446.....	483	MS-1295.....	135	STDBH.....	523
MH21-346.....	476	MH27-446C.....	483	MSRC-14.....	135	STDBH6.....	523
MH21-348.....	476	MH27-447.....	483	MSRC-18.....	135	STDBHS.....	523
MH21-368.....	476	MH27-447C.....	483	NYU B1.....	201	STDBOL.....	521
MH21-369.....	476	MH27-448.....	483	PKT 3.....	201	STDBOM.....	521
MH21-370.....	476	MH27-448C.....	483	PM-405.....	380	STDBOS.....	521
MH21-536.....	440	MH27-488.....	483	PM-805.....	397	STDCHEM.....	525
MH21-600.....	440	MH27-490.....	483	PM-2123.....	131	STDDRY.....	525
MH21-602.....	440	MH27-492.....	483	PM-2123.....	381	STDES60.....	523
MH21-604.....	440	MH27-494.....	483	PM-2211.....	410	STDES72.....	523
MH21-610.....	440	MH27-496.....	483	PM-2215.....	410	STDIND.....	525
MH21-626.....	463	MH27-498.....	483	PM-2216.....	410	STDORTHO.....	522
MH21-627.....	463	MH27-499.....	483	PM-2420.....	113	STDORTHOS.....	522
MH21-630.....	440	MH27-500.....	483	PM-2424.....	113	STDPB.....	523
MH21-632.....	440	MH27-502.....	483	PM-2425.....	113	STDSDL27.....	515, 519
MH22-662.....	454	MH27-504.....	483	PM-2426.....	113	STDSTAT.....	520
MH22-668.....	454	MH27-506.....	483	PM-2511.....	56	STDSTAT8.....	520
MH22-854.....	471	MH27-508.....	483	PM-3503.....	56	STDSTAT814.....	520
MH23-1049.....	471	MH27-700.....	476	PM-3504.....	56	STDSTEAM.....	525
MH23-1050.....	475	MH27-702.....	476	PM-3505.....	56	STN-ARK-CON.....	235, 342, 512
MH23-1051.....	475	MH27-820.....	484	PM-3738.....	380	STN-ARK-FLT-4.....	235, 342, 512
MH25-384.....	463	MH27-822.....	484	PM-3819.....	410	STN-IND-CON-309.....	512
MH25-390.....	463	MH27-824.....	484	PM-3830.....	410	STN-IND-FLT-1.....	512
MH25-392.....	463	MH27-826.....	484	PM-3831.....	410	STN-IND-WDG-6.....	512
MH25-396.....	463	MH27-990.....	455	PM-4137.....	381	STN-OIL.....	512
MH25-454.....	480	MH27-1000.....	440	PM-4205.....	140	SURGHIPPOST.....	510
MH25-456.....	480	MH27-1016.....	455	PM-4270FO.....	179	SURGHIPBOX.....	510
MH25-458.....	480	MH27-3070.....	441	PM-4311.....	364	SVET-23E/18P.....	235, 236, 342
MH25-480.....	480	MH27-3100.....	441	PM-4312.....	364	SVET-5004.....	235, 238, 342
MH25-510.....	480	MH28-68.....	472	PM-4570FO.....	179	SVET-5201.....	235, 246, 342
MH25-511.....	480	MH28-69.....	472	PM-4571FO.....	179	SVET-5202.....	235, 246, 342
MH25-800.....	454	MH30-1025.....	455	PM-4697.....	56	SVET-5450.....	235, 252, 342
MH25-814.....	454	MH30-1405.....	485	PM-4698.....	56	SVET-767.....	235, 238, 342
MH25-836.....	454	MH30-1442.....	485	PM-4699.....	56	TB7WAX.....	208
MH25-837.....	454	MH30-1443.....	485	PM-4841.....	48	TB21.....	201
MH26-119.....	487	MH30-1482.....	485	PM-4956.....	345	TB18P.....	201
MH26-124.....	487	MH30-1485.....	485	PM-5010.....	364	TB19P.....	201
MH26-956.....	447	MH30-1700.....	455	PM-5012.....	364	TB31W.....	208
MH26-958.....	447	MH30-1710.....	455	PM-5015.....	364	TB115.....	201
MH26-1084.....	475	MH30-1716.....	455	PM-5020.....	364	TB2628.....	201
MH26-1090.....	475	MH30-1718.....	455	PM-5551FO.....	179	TB2630.....	201
MH26-1410.....	484	MH30-395.....	472	PM-6535.....	27	TB2730.....	201
MH26-1412.....	484	MH30-406.....	472	PM-6751.....	35, 130	TBAP12.....	200
MH26-1627.....	479	MH30-415.....	472	PM-6770.....	34, 129	TBBR.....	200
MH26-1628.....	479	MH33-140.....	487	PM-6780.....	34, 129	TBBRK.....	200
MH26-1629.....	479	MH33-142.....	487	PM-6810.....	10	TBNYUB1.....	201
MH26-1630.....	479	MH6008.....	428	PM-6811.....	10	TBPKT3.....	201
MH26-1632.....	479	MH6800.....	428	PM-6812.....	10	TCCD2.....	202
MH26-1634.....	479	MH6810.....	428	PM-6813.....	10	TCCD3.....	202
MH26-1636.....	479	MH6820.....	428	PM-6832.....	12	TCHL3.....	202
MH26-1638.....	479	MS-117.....	134	PM-6832TC.....	12	TCHL12.....	202
MH26-1640.....	479	MS-126.....	134	PM-6833.....	12	TCIP.....	202
MH27-4.....	463	MS-140.....	134	PM-6833TC.....	12	TCIP1.....	202
MH27-7.....	463	MS-140A.....	134	PM-9043.....	56	TCIP2.....	202
MH27-16.....	463	MS-140S.....	134	PM-044402.....	392	TCPKT4.....	202
MH27-30.....	463	MS-141.....	134	PM-044404.....	392	TCTN5.....	202
MH27-32.....	463	MS-150.....	134	PM-044406.....	392	TCUM1.....	202

TD12X.....	204	TPG1114.....	240	TPRP910R.....	243	V90-88L.....	496
TD2X.....	204	TPG12.....	240	U76L.....	317	V90-88L-CG.....	496
TD4X.....	204	TPG1213.....	240	U76S.....	317	V90-88L-SG.....	496
TD5X.....	204	TPG12R.....	241	UB24.....	208	V90-88R.....	496
TD6X.....	204	TPG1314.....	240	UE25.....	311	V90-88R-CG.....	496
TD8X.....	204	TPG1314R.....	241	UE25NT.....	311	V90-88R-SG.....	496
TD9X.....	204	TPG1516.....	240	UE30.....	311	V90-150.....	496
TF13.....	310	TPG1516R.....	241	UE30NT.....	311	V90-150-CG.....	496
TF35.....	310	TPG1718.....	240	UE35.....	311	V90-150-SG.....	496
TF57.....	310	TPG34.....	240	UE40.....	311	V90-150S.....	496
TF71.....	230	TPG34R.....	241	UE40NT.....	311	V90-150S-CG.....	496
TF152.....	230	TPG56.....	240	UE45.....	311	V90-150S-SG.....	496
TF253.....	230	TPG56R.....	241	UE50.....	311	V90-151.....	496
TF911.....	230	TPG78.....	240	UE50NT.....	311	V90-151-CG.....	496
TF911.....	310	TPG78R.....	241	UE55.....	311	V90-151-SG.....	496
TFB1.....	230	TPG910.....	240	UE60.....	311	V90-151S.....	496
TFB2.....	230	TPG910R.....	241	UE60NT.....	311	V90-151S-CG.....	496
TFBL01.....	230	TPH1819.....	206	UED11.....	311	V90-151S-SG.....	496
TFBL12.....	230	TPH67.....	238	UED11T.....	311	V91-226.....	494
TFD100140X.....	310	TPJ23.....	239	UEGP2.....	311	V92-70.....	491
TFD3545N.....	310	TPJ2S3S.....	239	UEGP3.....	311	V92-72.....	491
TFD3545NXL.....	310	TPJ3033.....	239	UEGP3N.....	311	V93-10.....	491
TFD6080N.....	310	TPJ33U15.....	239	UF100.....	310	V95-2.....	490
TFD6080NXL.....	310	TPJ3435.....	239	UF110.....	310	V95-4.....	490
TFOR3.....	230	TPMC1112.....	246	UF130.....	310	V95-6.....	490
TGF13.....	205	TPMC1314.....	246	UF30.....	310	V95-8.....	490
TGF15.....	205	TPMC13S14S.....	246	UF35.....	310	V95-9.....	490
THCB15.....	203	TPMC1718.....	246	UF40.....	310	V95-12.....	490
THCB1718.....	203	TPMC17S18S.....	246	UF45.....	310	V95-16.....	490
THCM61.....	203	TPOR67.....	206	UF50.....	310	V95-18.....	490
THE15.....	199	TPOR89.....	206	UF55.....	310	V95-19.....	490
THE18.....	199	TPP1112.....	244	UF60.....	310	V95-22.....	490
THE19.....	199	TPP1112R.....	245	UF65.....	310	V95-26.....	490
THE31L.....	199	TPP1114.....	244	UF70.....	310	V95-28.....	490
THE33L.....	199	TPP1114R.....	245	UF80.....	310	V95-29.....	490
THE115.....	199	TPP12.....	244	UF85.....	310	V95-32.....	490
THEE2.....	199	TPP1213.....	244	UF90.....	310	V95-36.....	490
THH1.....	205	TPP1213R.....	245	UHC15.....	203	V95-38.....	490
THH1B.....	205	TPP12R.....	245	UK1.....	248	V95-42.....	490
THH15.....	205	TPP1314.....	244	UKK29.....	283	V95-46.....	490
THHO13.....	206	TPP1314R.....	245	UM.....	252	V95-48.....	490
THHO812.....	206	TPP1516.....	244	UMS.....	252	V95-52.....	490
TK23.....	248	TPP1516R.....	245	UPU15.....	238	V95-56.....	490
TK24G.....	268	TPP1718.....	244	V1718.....	490	V95-58.....	490
TKB56.....	248	TPP34.....	244	V90-1STD.....	495	V95-120.....	490
TKGF14.....	268	TPP34R.....	245	V90-1STD-CG.....	495	V95-122.....	490
TKHI37.....	247	TPP56.....	244	V90-1STD-SG.....	495	V95-124.....	490
TKHI511.....	247	TPP56R.....	245	V90-10S.....	495	V95-126.....	490
TKHI910.....	247	TPP78.....	244	V90-10S-CG.....	495	V95-180.....	490
TKK1313L.....	248	TPP78R.....	245	V90-10S-SG.....	495	V95-182.....	490
TKLU85.....	270	TPP910.....	244	V90-16.....	495	V95-304.....	490
TKLU86.....	270	TPP910R.....	245	V90-16-CG.....	495	V95-306.....	490
TKLU87.....	270	TPPR12.....	270	V90-16-SG.....	495	V95-312.....	490
TKLU88.....	270	TPRE34.....	238	V90-17.....	495	V95-314.....	490
TKM10.....	270	TPRP1112.....	242	V90-17-CG.....	495	V95-500SS.....	490
TKM11.....	270	TPRP1112R.....	243	V90-17-SG.....	495	V95-502SS.....	490
TKMO24.....	270	TPRP1114.....	242	V90-23.....	495	V95-504SS.....	490
TKOC3.....	283	TPRP1114R.....	243	V90-23-CG.....	495	V95-506SS.....	490
TKOC4.....	283	TPRP12.....	242	V90-23-SG.....	495	V95-524.....	490
TKOR1011.....	247	TPRP1213.....	242	V90-53L.....	495	V95-532.....	490
TKOR12.....	248	TPRP1213R.....	243	V90-53L-CG.....	495	V95-550.....	490
TKOR1213.....	247	TPRP12R.....	243	V90-53L-SG.....	495	V95-560.....	490
TKPR3.....	268	TPRP1314.....	242	V90-53R.....	495	V95-568.....	490
TKRH3637.....	206	TPRP1314R.....	243	V90-53R-CG.....	495	V95-600.....	490
TKSC910.....	247, 281	TPRP1516.....	242	V90-53R-SG.....	495	V95-1000.....	490
TKSU12.....	247, 281	TPRP1516R.....	243	V90-62.....	496	V95-1025.....	490
TKSU34.....	247, 281	TPRP1718.....	242	V90-62-CG.....	496	V95-1026.....	490
TNPKT1.....	201	TPRP34.....	242	V90-62-SG.....	496	V95-1027.....	490
TP204S.....	238	TPRP34R.....	243	V90-65.....	496	V95-1028.....	490
TPBA12.....	246	TPRP56.....	242	V90-65-CG.....	496	V95-1029.....	490
TPBA56.....	246	TPRP56R.....	243	V90-65-SG.....	496	V95-1030.....	490
TPC1314.....	246	TPRP78.....	242	V90-69.....	496	V96-1.....	491
TPG1112.....	240	TPRP78R.....	243	V90-69-CG.....	496	V96-4.....	491
TPG1112R.....	241	TPRP910.....	242	V90-69-SG.....	496	V96-6.....	491

V96-8	491	V97-520	493	V919-434A	493	V96050/6	495
V96-10	491	V97-584	492	V920-140	493	V96051	181
V96-14	491	V97-585	492	V920-142	493	V96052	181
V96-16	491	V97-588	492	V927-4	493	V96053	181
V96-18	491	V97-590	492	V927-7	493	V966-317	494
V96-40	491	V97-591	492	V927-1390	493	V966-652	494
V96-42	491	V97-600	492	V927-3100	493	V96800	494
V96-44	491	V97-604	492	V930-2100	360	V96810	494
V96-46	491	V97-610	492	V930-2101	360	V96820	494
V96-104	491	V97-622	492	V930-2102	360	VST	513
V96-106	491	V98-2	493	V930-2103	360	VSTA	513
V96-118	491	V98-4	493	V930-2104	360	VSTSA	513
V96-120	491	V98-6	493	V930-2105	360	VSTSB	513
V96-124	491	V98-8	493	V930-2106	360	VSTSD	513
V96-142	491	V98-15	493	V930-2107	360	VSTSG	513
V96-197	491	V98-16	493	V930-2108	360	VSTSK	513
V96-300	491	V98-17	493	V933-140	494	VSTSL	513
V96-304	491	V98-28	493	V933-142	494	VSTSN	513
V96-312	79, 491	V98-40	493	V933-200	494	VSTSP	513
V96-314	491	V98-42	493	V933-201	494	VSTSR	513
V96-316	491	V98-44	493	V971-50	495	VSTSU	513
V96-318	491	V98-46	493	V971-51	495	VSTSW	513
V96-329	79, 491	V98-48	493	V971-52	495	VSTSY	513
V96-336	79, 491	V98-50	493	V971-53	495		
V96-400	79, 491	V99-60	492	V971-54	495		
V96-410	79, 491	V99-100	490	V971-55	495		
V97-2	491	V99-102	490	V971-62	495		
V97-4	491	V99-104	490	V971-63	495		
V97-24	491	V99-124	490	V971-64	495		
V97-26	491	V99D-133	490	V971-65	495		
V97-30	491	V99D-135	490	V971-66	495		
V97-32	491	V911-74	494	V971-67	495		
V97-36	491	V911-366	494	V971-68	495		
V97-38	491	V911-600	494	V971-69	495		
V97-42	491	V911-602	494	V973-48	495		
V97-44	491	V911-608	494	V973-52	495		
V97-46	491	V911-610	494	V973-54	495		
V97-48	491	V911-614	494	V973-62	495		
V97-66	491	V911-616	494	V973-70	495		
V97-68	491	V916-6	492	V973-72	495		
V97-92	491	V916-8	492	V974-20	495		
V97-94	491	V916-10	492	V974-30	495		
V97-118	491	V916-44	492	V974-40	495		
V97-120	491	V916-160	492	V974-45	495		
V97-122	491	V916-162	492	V974-50	495		
V97-124	491	V918-412	494	V974-55	495		
V97-126	491	V918-780	492	V974-75	495		
V97-128	491	V918-782	492	V91722	194		
V97-136	491	V918-784	492	V91723	194		
V97-138	492	V918-786	492	V91724	194		
V97-140	492	V918-788	492	V91725	194		
V97-142	492	V918-790	492	V91726	194		
V97-144	492	V918-850	492	V91727	194		
V97-146	492	V918-866	492	V91728	194		
V97-150	492	V918-868	492	V91729	194		
V97-152	492	V918-1110	492	V91730	194		
V97-154	492	V918-1462	490	V91731	194		
V97-156	492	V918-1466	490	V91732	194		
V97-157	492	V918-1652	490	V96006	494		
V97-160	492	V918-1828	493	V96008	494		
V97-162	492	V919-280	494	V96010	425		
V97-164	492	V919-282	494	V96011	425		
V97-166	492	V919-284	494	V96012	425		
V97-167	492	V919-286	494	V96014	425		
V97-170	492	V919-288	494	V96032	191		
V97-172	492	V919-350	492	V96033	191		
V97-180	492	V919-370	492	V96034	191		
V97-182	492	V919-381	494	V96036	191		
V97-500	493	V919-383	494	V96037	191		
V97-504	493	V919-385	494	V96038	191		
V97-506	493	V919-390	494	V96044	191		
V97-510	493	V919-394	494	V96045	191		
V97-514	493	V919-396	494	V96050	181		
V97-515	493	V919-434	493	V96050/1	495		

ASK US ABOUT OUR..



CARE & CLEANING PROGRAM!

For more information or to place an order, please contact:
Integra York PA, Inc. ■ 589 Davies Drive, York, PA 17402
866-854-8300 USA ■ 717-840-2763 outside USA ■ 717-840-9335 fax
integralife.com/integra-miltex



+H834CATAH0M