

## Medical Measuring Systems and Scales since 1840

### North America West

seca corp.  
13601 Benson Avenue  
Chino · CA 91710 · USA  
phone +1 800 542 7322  
fax +1 888 705 7397  
info.us@seca.com

### North America East

seca corp.  
7240 Parkway Drive, Suite 120  
Hanover · MD 21076 · USA  
phone +1 800 542 7322  
fax +1 888 705 7397  
info.us@seca.com

### Germany

seca gmbh & co. kg  
Hammer Steindamm 3-25  
22089 Hamburg · Germany  
phone +49 40 20 00 00 0  
fax +49 40 20 00 00 50

seca operates worldwide with headquarters  
in Germany and branches in:

**seca** france  
**seca** united kingdom  
**seca** north america  
**seca** schweiz  
**seca** zhong guo  
**seca** nihon  
**seca** mexico  
**seca** austria  
**seca** polska  
**seca** middle east  
**seca** brasil  
**seca** suomi  
**seca** américa latina  
**seca** asia pacific

and with exclusive partners in  
more than 110 countries.

All contact data under [www.seca.com](http://www.seca.com)

202384016017



**Every question  
helps us improve.**

For more information on seca  
products please call:

**1-800-542-7322**

Of course, you can  
also find answers to your  
questions online at:

**www.seca.com**

An innovation  
**its worth**

Doctors, nurses and other health care professionals value technology that supports them in their day-to-day work and helps them save time. Our products help to shorten routine procedures and prevent errors. The intuitive control systems save training time, while the high level of reliability and quality guarantee precise measurements every time and everywhere. Our effective, global seca service network also contributes to this. Mobile or stationary, a little or plenty of space, for constant or only

is something that proves  
**in day-to-day work.**

occasional use – we offer the right products for a wide range of situations and requirements. The key factor, however, is that every seca product forms part of a system solution. This is the only way to ensure that devices can be fully integrated, processes networked and the number of work steps reduced.

**Our products are sold  
through medical distributors.  
This guarantees the level of  
reliability and service that  
you expect from us.**



Robert M. Vogel  
CEO Sales & Marketing

Frederik Vogel  
CEO Development & Manufacturing

Thomas Wessels  
CEO Finance & Services

# Best-fit products by medical area of application

**Primary care**



seca mBCA 514  
Page 10



Column scale seca 703  
Page 56



Flat scale seca 874 dr  
Page 71



Measuring station  
seca 286 dp  
Page 50

**Gynecology & obstetrics**



Column scale seca 703  
Page 56



Flat scale seca 869  
Page 67

**Neonatology**



Baby scale seca 727  
Page 30



Infantometer seca 416  
Page 38

**Intensive care**



Platform scale seca 656  
Page 88



Bed and dialysis scale seca 984  
Page 92

**Cardiology**



Column scale seca 703  
Page 56



seca mBCA 514  
Page 10

**Pediatrics**



Baby scale seca 374  
Page 32



Infantometer seca 416  
Page 38



Measuring station  
seca 284 dp  
Page 52



**Acute care**



seca mBCA 514  
Page 10



Wheelchair scale seca 676  
Page 86



Measuring station  
seca 284 dp  
Page 52



Stadiometer seca 274  
Page 76

**Long term care**



seca mBCA 514  
Page 10



Measuring station  
seca 286 dp  
Page 50



Wheelchair scale seca 676  
Page 86

**Endocrinology & diabetology**



seca mBCA 514  
Page 10



Measuring station  
seca 284 dp  
Page 52



Platform and bariatric  
scale seca 634  
Page 66



Telescopic measuring  
rod seca 222  
Page 79

**Nephrology & dialysis**



seca mBCA 514  
Page 10



Multifunctional scale seca 684  
Page 85



Platform scale seca 674  
Page 89



Chair scale seca 954  
Page 90

**Field studies & mobile use**



Baby scale seca 354  
Page 36



Measuring board seca 417  
Page 40



Mobile measuring and  
weighing system  
Page 69

**Geriatrics**



Chair scale seca 954  
Page 90



Wheelchair scale seca 676  
Page 86

**Clinical nutrition**



seca mBCA 514  
Page 10



Measuring station  
seca 286 dp  
Page 50

For more information on seca products or services, contact us at:

**1-800-542-7322**

**Contents**



**01** seca mBCA ..... **08**



**02** seca 360° wireless ..... **18**



**03** Pediatric scales and measuring systems ..... **28**

Baby scales ..... **30**

Pediatric measuring systems ..... **38**



**04** Measuring stations and column scales ..... **48**

Measuring stations ..... **50**

Column scales ..... **56**



**05** Flat scales ..... **64**



**06** Height measuring systems ..... **74**



**07** Multifunctional and wheelchair scales ..... **82**

Chair scales ..... **90**

Bed and dialysis scale ..... **92**

**08** Specialized scales ..... **94**

Organ and diaper scale ..... **94**

Digital portion and diet scale ..... **95**

**09** Digital printers with wireless transmission ..... **96**

**10** Software ..... **98**

Technical data ..... **102**

seca technical terms ..... **124**

seca green ..... **126**

The brand of the medical field ..... **128**

seca and art ..... **130**

**seca** innovations



**12** **seca mBCA 525**  
the new compact class  
for mobile Body  
Composition Analysis



**18** **seca 360° wireless**  
the world's first wireless  
product system



**50** **seca 286 dp**  
wireless ultrasonic  
measuring station for  
height and weight with  
voice guidance



**86** **seca 676**  
digital wheelchair scale  
with handrail and wireless  
transmission

# seca | mBCA

Where BMI ends, the seca medical Body Composition Analyzer begins.

**S**ize and weight alone are not enough for a more extensive analysis of a patient's body composition. What about fat, muscle and water content? All of these are important indicators of serious diseases. This is precisely why we at seca developed medical Body Composition Analyzers, which provide all of these values and have been validated to the medical science gold standard\*: It is thereby possible to determine the fat mass, visceral fat, extracellular and intracellular water or the skeletal muscle mass in a medically precise way. In short: The seca mBCA analyzers are innovative instruments for the support of diagnosis and therapy control and enable successful patient consultations.

## With five decisive advantages for medicine

- 1** Medically precise measurements.
- 2** Assessment of the general health and nutritional status of the patient.
- 3** Fast examination through short measuring times.
- 4** Early indicators of various diseases.
- 5** Exact monitoring of courses of therapy.

\* Studies:  
Bosy-Westphal A, Schautz B, Later W, Kehayias JJ, Gallagher D. What makes a BIA equation unique? Validity of eight-electrode multifrequency BIA to estimate body composition in a healthy adult population. Eur J Clin Nutr 2013; 67: 14-21; doi:10.1038/ejcn.2012.160

# Simplified work, quick measurement and medically relevant results, that is the seca mBCA 514.

The seca mBCA 514 is a medical Body Composition Analyzer, which is ideally adapted to the working conditions in hospitals and medical practices. After all, in order to obtain a truly meaningful BIA measurement (bioelectrical impedance analysis), we need to look beyond the many technical requirements. For one thing, the device has to be quick and easy to use for medical staff. For another, the measurement results have to be reproducible under normal clinical working conditions. These exact considerations went into the development of the seca mBCA 514.

## seca mBCA 514

### Technical data

- Capacity: 660 lbs / 300 kg
- Division: 0.1 lbs < 330 lbs > 0.2 lbs / 50 g < 150 kg > 100 g
- Dimensions (WxHxD): 38.4 x 49.3 x 32.6" / 976 x 1,251 x 828 mm
- Display type: 8.4" touch-screen display, can be rotated 360°
- Interfaces: seca 360° wireless, USB 2.0, Ethernet
- Measurement method: 8-point Bioelectrical Impedance Analysis
- Measurement current: 100 µA
- Measurement time, normal mode: max. 17 seconds
- Frequencies: 19

 **System compatible** with seca 360° wireless measuring systems, seca analytics 115 software.



The intuitive user navigation permits operation of the seca mBCA 514 without hours of training.



The integrated touch-screen display not only allows you to enter patient data; it also enables you to monitor the progress of the measurement and conveniently analyze the results from many different perspectives.

The unique standing aid guarantees that the patient always stands in the same measuring position. This ensures the reproducibility of the measurement results.

## seca | service

### For seca mBCA 514:

- On-site seca mBCA installation service including seca network configuration
- On-site seca mBCA maintenance service



The data and measurements are sent via an Ethernet or wireless connection to the PC software, which then integrates them into the Electronic Medical Record (EMR) system via the internal network.



Hand-held electrodes prevent measurement errors and ensure that results are always reproducible.

The large, easy-access, fast-cleaning, safety glass weighing platform is suitable for use by patients weighing up to 300 kg.

# The new benchmark in lying BIA measurement – the seca mBCA 525.

The seca mBCA 525 is the mobile solution for bioelectrical impedance analysis (BIA). Its low weight, good handling and precise measurement technology make it very efficient and versatile. Its technology is one-of-a-kind in the world because fat mass, muscle mass, and body water are determined with a newly developed measuring mat. It is automatically networked by Wi-Fi to the touchscreen monitor, which can store up to 100,000 measurements. This enables many patients to be measured and courses of therapy to be reliably documented for years.

The clearly organized presentation of all measurement results simplifies diagnosis and thereby the patient consultation as well. The pressure-sensitive technology enables the menu to be operated even while wearing gloves or under a protective covering.



The measuring mat is a true multifunctional tool. It is powered by its own rechargeable battery that is charged by induction and therefore operated fully self-sufficiently. The measured data is transferred to the monitor via a Wi-Fi signal.



## seca mBCA 525

### Technical data

- Weight: 6.6 lbs / 3 kg
  - Electrode type: adhesive electrodes (PVC-free)
  - Dimensions (WxHxD): 9.9 x 10.3 x 9.1" / 252 x 262 x 230 mm
  - Interfaces: Wi-Fi, Ethernet, USB 2.0, seca 360° wireless technology
  - Measurement method: 8-point Bioelectrical Impedance Analysis
  - Power supply: power adapter, rechargeable battery
  - Display type: 7" touch-screen display
  - Measurement current: 100 µA
  - Measurement time: 30 seconds
  - Frequencies: 8
  - Measured data storage: up to 100,000 measurements
  - Housing made of flame-retardant plastic
  - Optional: mobile stand seca 475, carrying case seca 432
- System compatible with seca 360° wireless measuring systems and scales, seca analytics 115 software.



The correct placement of the electrodes is illustrated on the measuring mat. Each measurement only begins after an automatic electrode test.



The electrodes have an Easy Snap™ mechanism and can be quickly connected with the adhesive electrodes without applying any pressure.

### Accessories

#### seca 475

Rolling stand with basket for the mobile use of the seca mBCA 525

The seca mBCA 525 can be mounted within seconds to the high-quality mobile stand with two screws. The five wheels are movable in all directions which optimizes overall navigation. An additional storage baskets provides space for further documents as well as for accessories.



### Accessories

#### seca 432

Carrying case for seca mBCA 525

The high-quality carrying case seca 432 can hold the seca mBCA 525 as well as further accessories such as electrodes, documents or power adapters. All parts can be safely stored in the customized separate compartments. Since the bag's material is durable and water-resistant, it is especially suitable for mobile use.



# Clear analysis, clear presentation – the seca mBCA analysis modules.



The analysis results of the seca mBCA analyzers offer the user numerous diagnosis options. With the precise analysis such as fat mass to body weight or extracellular to intracellular water indications of various illnesses can be detected. The seca mBCA 525 also includes the ability to save numerous measurements so that courses and progresses of therapy can be documented. The clearly organized graphical presentation of the measured values on the monitor or as a one-page printout is also very helpful for the patient consultation.

## **BCC** Body Composition Chart (BCC)

It seems simple to roughly differentiate between malnourished or obese individuals. However, an extremely thin patient can have a lot of body fat while a seemingly overweight patient can have a high amount of muscle mass. The clearly arranged presentation provides immediate information about the body composition of your patients so you can instantly draw conclusions for therapeutic decisions. Series of measurements enable the therapy to be reliably monitored and controlled.

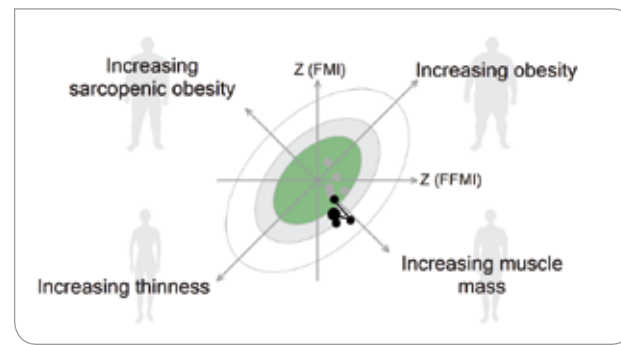

## **FM** Fat mass / fat-free mass / visceral fat

Fat mass and fat-free mass can be quickly, reliably and precisely recorded only by means of a BIA measurement. It helps to determine and monitor the correct nutritional therapy. The amount of visceral fat can also be precisely determined, which is otherwise possible only through time-consuming imaging procedures. This enables an estimate of the cardiometabolic risk and helps with the determination of further therapeutic strategies.

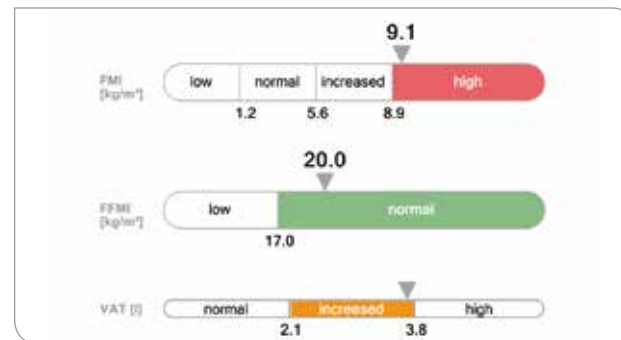

## **Body water**

Total body water, intracellular water and extracellular water are measured separately. This supports the detection of edemas, the improved evaluation of weight increase and decrease and the detection of states of dehydration.

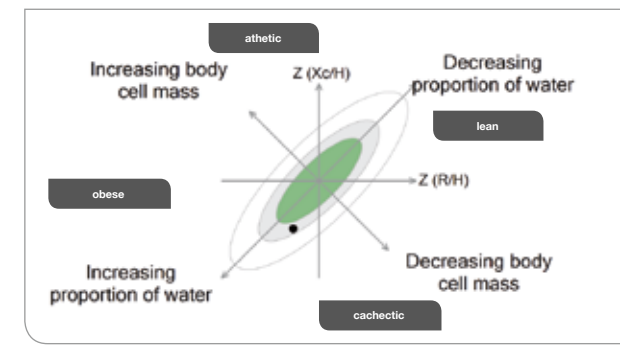
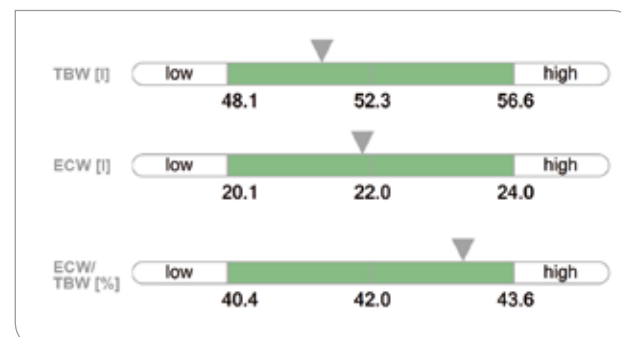

## **BIVA** Bioelectrical impedance vector analysis (BIVA)

The BIVA forms an important diagnostic basis for nutritional medicine. The measuring point provides information about the state of hydration and the body cell mass, which provides a good overview of the general state of health and nutrition. This makes it possible to detect whether there is malnutrition or if an intervention by means of infusions is necessary, for example. Monitoring over the course of time is especially important for stationary treatments.

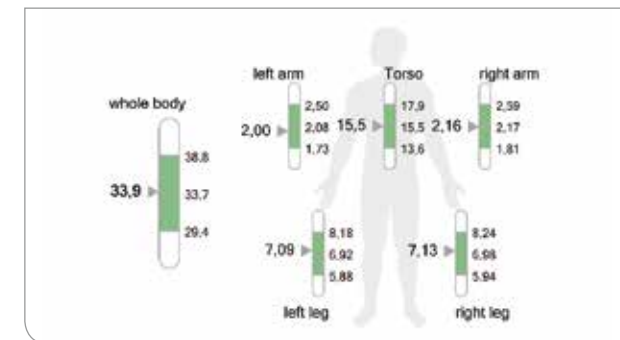

## **SMM** Skeletal muscle mass

The values for the torso and extremities are provided individually and displayed in a graphic. Increasing and maintaining muscle mass plays a key role in nutritional medicine because it helps to burn fat and positively influences the body's energy.

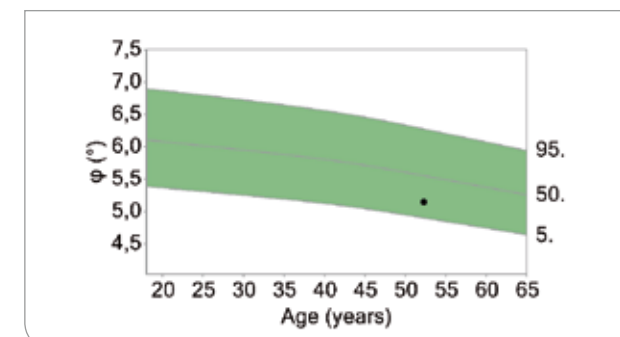

## **Phase angle**

Studies\* verify that a high phase angle shows a good condition of the cells and their functions. A very low phase angle is measured in the case of malnutrition and oncology patients, for example. It is a very good parameter for the general state of health. In diagnostics the severity of many illnesses as well as general states of exhaustion can be verifiably better determined.

\*Studies:  
Mattar JA. Application of total body bioimpedance to the critically ill patient. Brazilian Group for Bioimpedance Study. New Horiz 1996; 4: 493–503  
Zdolsek HJ, Lindahl OA, Sjöberg F. Non-invasive assessment of fluid volume status in the interstitium after haemodialysis. Physiol Meas 2000; 21: 211–220  
Dittmar M. Reliability and variability of bioimpedance measures in normal adults: effects of age, gender and body mass. Am J Phys Anthropol 2003; 122: 361–370



# Examination results are only as valuable as the analysis performed.

The seca analytics 115 PC software.

## More in-depth analysis

The seca analytics 115 PC software does more than simply upload the examination results from the seca mBCA analyzers to your PC. It expands on them significantly, for instance with a module for cardio-metabolic risk or a therapy planner.

## seca 360° wireless

The measurements from the seca mBCA 514 and other seca 360° wireless products can be received wirelessly by a PC running the seca analytics 115 software. The seca mBCA 525 transmits the measurement results directly via Wi-Fi.

## Digital patient files

Only EMR-integrated products such as seca analytics 115 can convert the data into the format required to process it in the Electronic Medical Record (EMR) systems.

## Solid scientific foundation

The seca mBCA analyzers and the seca analytics 115 PC software use the latest scientific references for the analysis and interpretation of the measurements.

## With six decisive advantages for medicine

- 1** Sets up the PC so that it can wirelessly receive the measurements of the seca mBCA and other seca 360° wireless devices.
- 2** Also, offers the Cardiometabolic risk module, the extension to the Raw impedance data module, additional interpretation options, trend curves and the therapy planner.
- 3** Can generate and print out clear graphs for all data – either for patient records or to provide a clear structure for patient consultation.
- 4** Stores all patient and examination data in a central seca database.
- 5** Enables clinics to take the first step toward digital patient records with EMR integration.
- 6** With the necessary security, thanks to simple user account management and access rights.

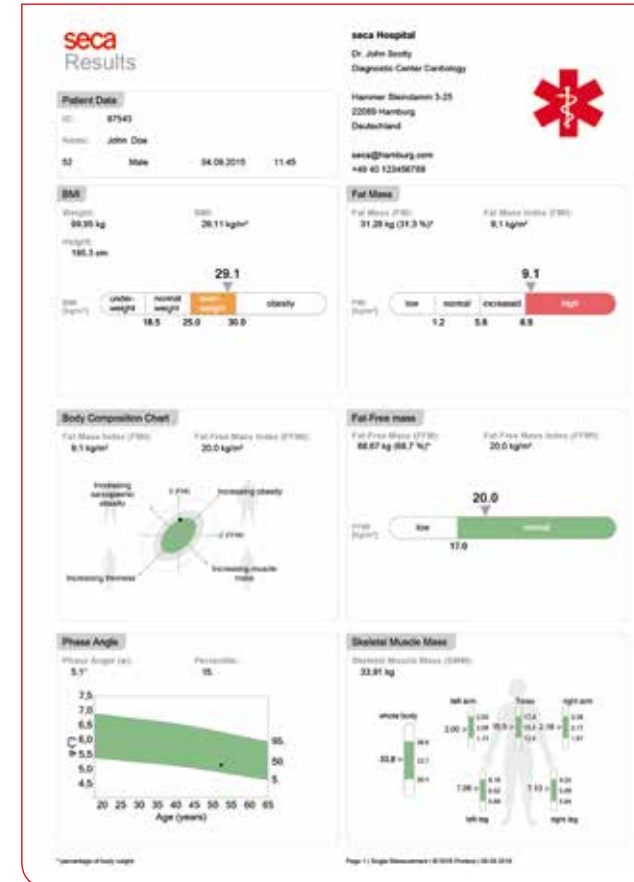

All examination results for each patient can be compiled into a PDF of one or more pages. The findings can be ideally prepared for a personal consultation.



The additional module Cardiomatabolic risk compares BMI and waist circumference to reference values, calculates the 10-year risk of coronary heart disease and checks whether a metabolic syndrome is present.

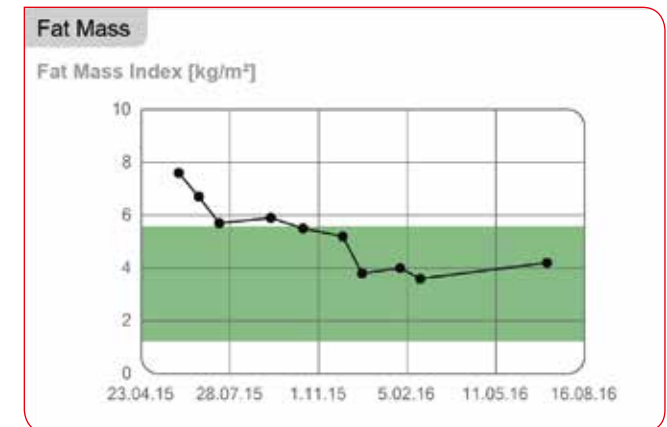

Trend curves document and monitor data such as the proportion of fat mass.



The therapy planner helps in the analysis of resting and total energy expenditure. It is becoming increasingly important, as more and more patients are suffering from malnutrition, overweight or obesity.

## seca | service

### For seca analytics 115:

- Remote or on-site installation service
- Remote or on-site EMR integration service
- Remote or on-site software support





# seca | 360° wireless

The only product system with wireless transmission.

The seca 360° wireless product system fits within your existing workflow and enhances patient education on maintaining a healthy weight. Once weight and height are captured the system wirelessly transmits measurements to your PC, where patient data is interpreted and compared to statistical norms. An immediate printout can be given to the patient to review while they wait in the exam room and assists in initiating weight discussion.

## With seven decisive advantages for medicine

- 1** Wireless transmission of measurements instead of cable connections.
- 2** System components can be conveniently set up anywhere.
- 3** seca's own secure wireless protocol for simple and fast recognition of devices in the seca 360° wireless network.
- 4** Paperless and error-free transmission of measurements.
- 5** seca analytics 115 PC software for diagnostic assistance based on an exact assessment of health status and nutritional condition of the patient.
- 6** Graphic presentation of measurements and their comparison to standard values – patient printout or electronic PDF.
- 7** Software seca emr flash 101 for direct transmission of measurements to any EMR system.

# The future belongs to networks – in medicine too.

If many experts join hands, they will work faster and more efficiently. That is the idea behind a network, and the same applies to the seca 360° wireless network with the seca analytics 115 PC software for diagnostic support. Otherwise, the seca emr flash 101 software can be downloaded for connecting seca 360 wireless products directly to any EMR system (see page 24). Here, the seca height measuring systems and scales are located in several rooms, and can work wirelessly with any number of PCs. With seca analytics 115, the nurse can access the data of an EMR system via a central interface, store height and weight measurements and print out the data for the patient to review while they wait to be seen by the doctor. Not only does this assist in preventing manual entry errors, but enhances patient education on maintaining a healthy weight.

# 360°

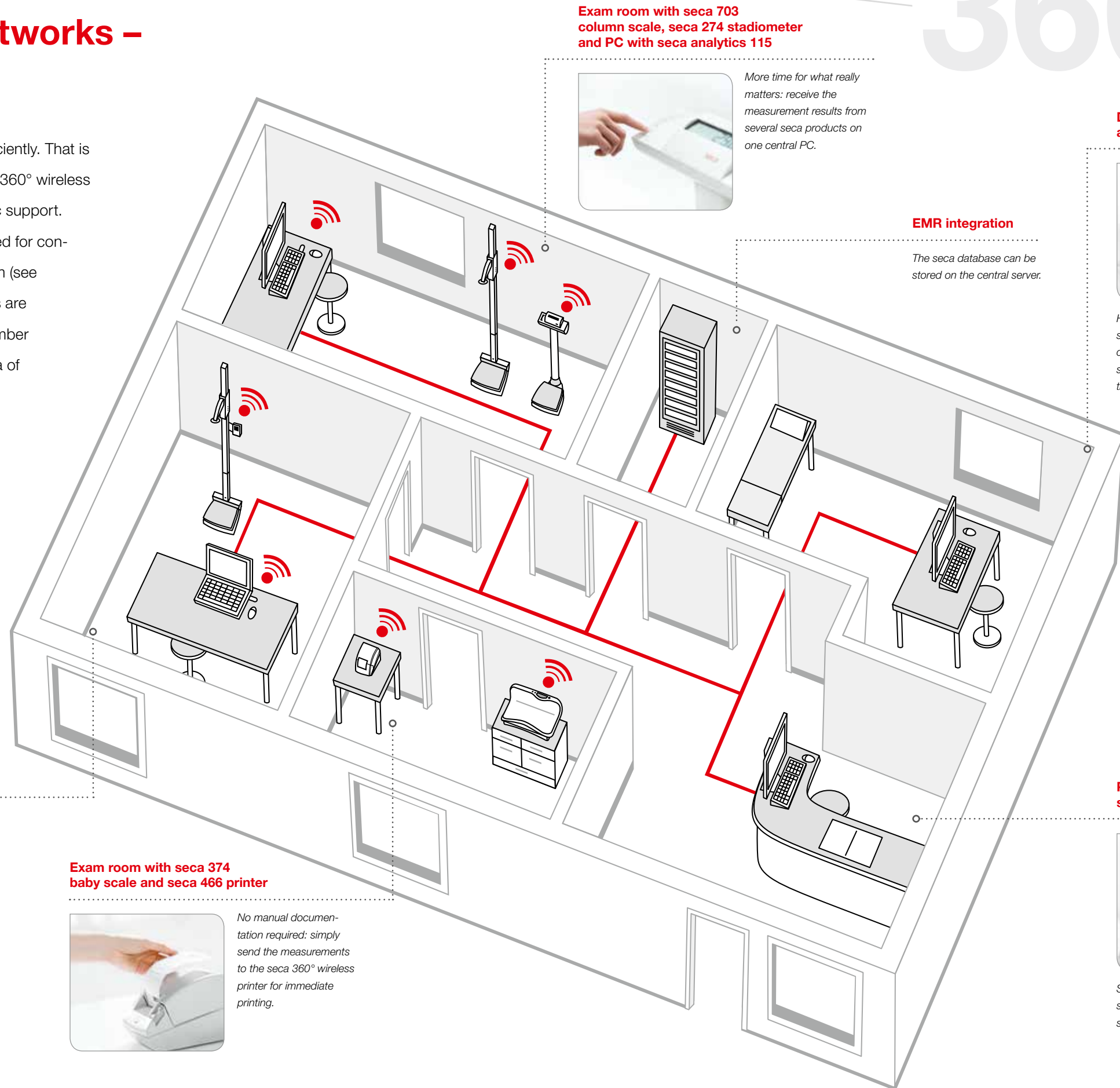

**Exam room with seca 703 column scale, seca 274 stadiometer and PC with seca analytics 115**



More time for what really matters: receive the measurement results from several seca products on one central PC.

**Doctor's office with PC and seca analytics 115**



Higher quality consultation: the seca analytics 115 PC software compares the results with the standard values and presents them clearly.

**EMR integration**

The seca database can be stored on the central server.

**Exam room with seca 284 dp measuring station and PC with seca analytics 115**



Measuring and weighing in one step. With seca analytics 115, all the measurement results are made available on the network immediately after the data is transferred.

**Exam room with seca 374 baby scale and seca 466 printer**



No manual documentation required: simply send the measurements to the seca 360° wireless printer for immediate printing.

**PC in reception with seca analytics 115**



Store patient data in EMR system and transfer to the seca analytics 115 PC software.

**One step ahead of the future:**  
direct EMR integration.

# 360°



**Wireless data transmission**

**EMR**

The wireless product system seca 360° wireless is the first of its kind in the world. Our products transmit data via a special medical wireless protocol to a simple, fast and secure seca network. Within seconds, measurements are transmitted wirelessly and assigned to the correct patient ID in your EMR system, or transferred to a seca 360° wireless printer. This increased efficiency allows your facility to concentrate on what's really important — the well-being of your patients.

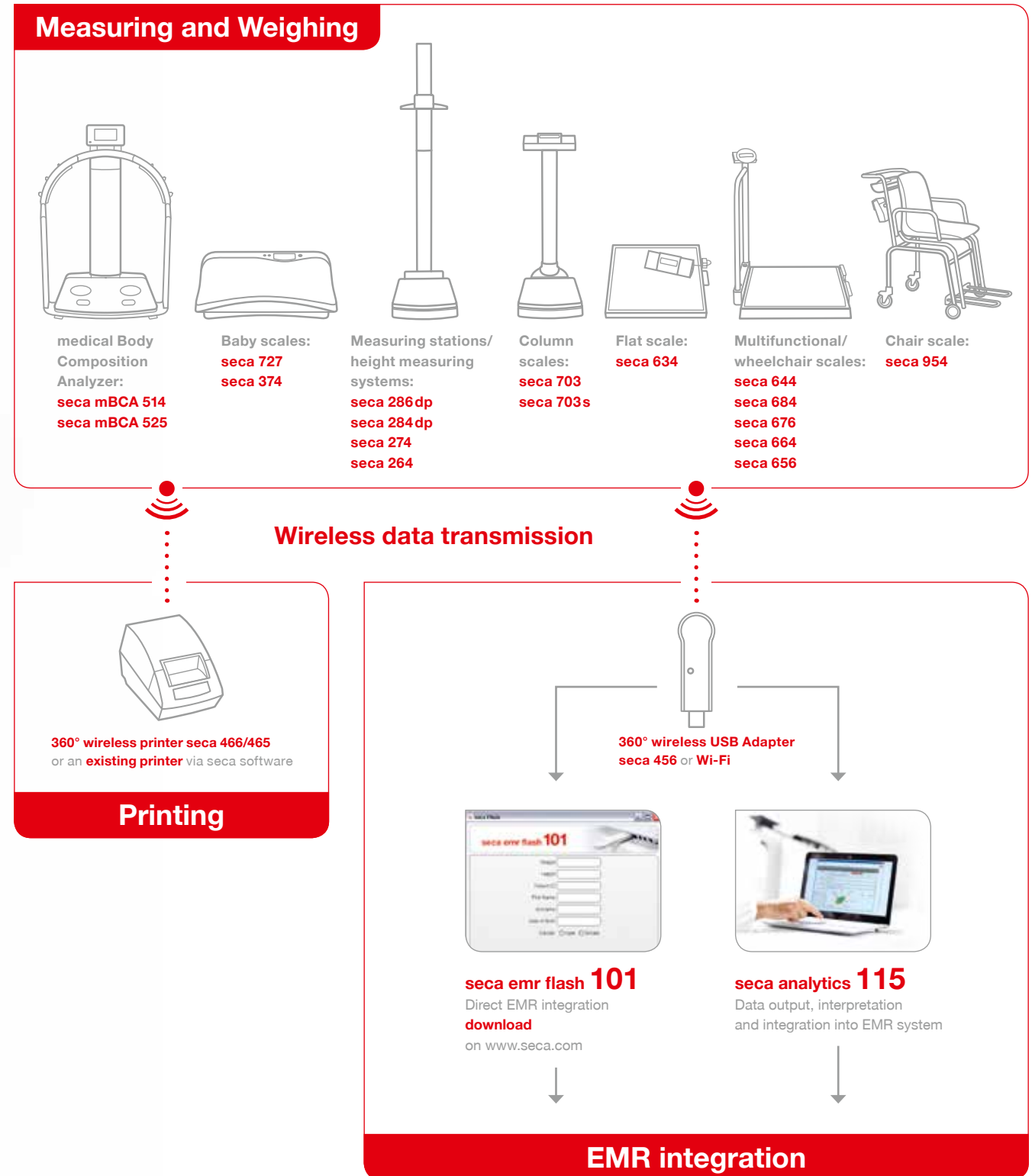

## seca emr flash 101 –

software for connecting the seca 360° wireless products to EMR systems.

Many devices bear the label “EMR-ready”, but in practice that isn’t enough. Only EMR-integrated products like the seca emr flash 101 and the seca analytics 115 software permit direct integration of data in an EMR system. They bring the data to internationally recognized standards (e.g. HL7 or GDT), which the EMR system requires for processing purposes. The only prerequisite is the USB adapter seca 456 for the PC, so it can receive the measurements from seca 360° wireless products.

### EMR modules

seca offers pre-developed software modules for various EMR systems such as Allscripts Professional. These solutions are very user-friendly through plug and play because 99% of all programming steps have already been carried out. It is also possible to connect via standard protocols (e.g. for the programming languages HL7 and GDT). Some support from the respective EMR system provider or the internal IT department is sufficient for integration into hospital or doctor’s practice databases. One individually configurable programming aid is the API (Application Programming Interface). A module for a specific EMR system can be independently developed in simple programming steps.

### seca keyboard module

The seca keyboard module is a data transmission module for the simple wireless transmission of height and weight into the desired electronic documentation by the click of your mouse.

### seca directprint module

Our tool for the perfect patient consultation. The clearly organized presentation of the printout simplifies the qualified and efficient weight consultation.

# 360°



**seca emr flash 101**  
download on [www.seca.com](http://www.seca.com)

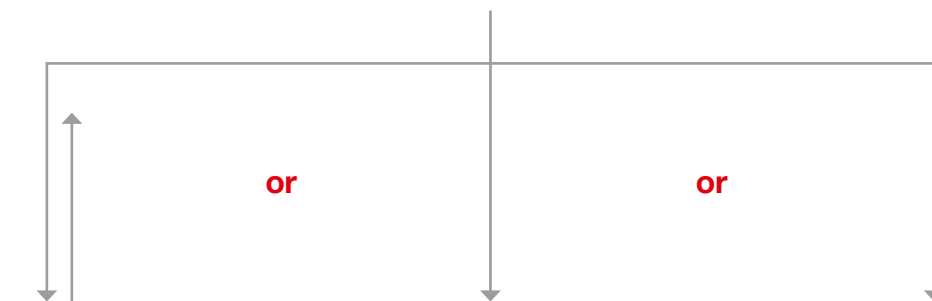

### Synchronization

#### EMR module



**EMR synchronization** directly into the patient’s file. All according to your wishes.

- **EMR modules:** Allscripts/ SystemOne/ Cerner **or**
- **Protocols:** HL7/ GDT **or**
- **API** (individual interface programming).

### Transmission

#### seca keyboard module



Quick and easy **transmission** of height and weight to any interface directly into your electronic documentation (e.g. into Excel or Word).

### Printout

#### seca directprint module



Personalized **printout** outlining the patient’s nutritional condition based on their BMI. Further information on page 26.



A lightweight printout for a weighty subject.

The seca directprint is the ideal tool for raising awareness of maintaining a healthy weight. It doesn't just tell your patient's their height, weight and BMI, it also gathers together their measurements with lots of sound information and tips in an easy-to-read one page printout. Each patient can be individually addressed and provided with the information most important for them.

Graphic with patient's height, weight and BMI data.

Explanation of Body Mass Index.

Teaser for extra services, e.g. bioimpedance analysis.

Chart explains energy use during physical activity.

Space for personal message from you to your patient.

**seca | Your BMI printout**

Dear Patient,  
The greatest contribution to your health is made by YOU!

There are simple criteria for determining your state of health. The Body Mass Index (BMI) considers your weight in relation to your height. Here are your personal measurements:

Weight (lbs): 220.46  
Height (in): 70.87  
BMI (kg/m<sup>2</sup>): 30.86

Note:  
Your BMI is above the normal range!

**seca tip**  
A good balance between weight and physical activity helps keep you healthy and mobile well into old age. Even if your success is not immediately obvious on the scale, you will feel fitter.

**Did you know?**  
Do your bit! Healthy eating and regular exercise will greatly reduce your risk of developing type 2 diabetes. Even gentle physical activity makes a big difference.

Weight loss made easy! Lose three kilos (6.6 pounds) or more in as little as six months with a balanced diet and a little exercise. Your doctor will be happy to support you with meal plans, exercise suggestions, and regular meetings to track your progress and help you meet your goals.

Activity	Swimming	Running	Cycling	Walking	Weights
Energy use	31 min	36 min	38 min	50 min	45 min
Energy use	15 min	17 min	18 min	24 min	22 min
Energy use	27 min	31 min	33 min	43 min	39 min
Energy use	3 min	4 min	4 min	5 min	4 min

Fun, sports & nutrition  
You can find more information at [www.seca.com/directprint](http://www.seca.com/directprint) or simply scan the QR code.

Your own practice logo and contact data.

Personal height, weight and BMI data.

Personalized comment on patient's health.

Nutrition tips.

Helpful advice on good health.

Additional information and interesting articles about seca directprint on our website.

## Easy installation and handling – without extra effort.

Quickly and easily obtain an ad hoc health assessment of your patient. In a matter of seconds, you can wirelessly transfer all height and weight measurements to your existing printer and immediately receive an individual printout for your patients.

**seca 286 dp**  
Wireless ultrasonic measuring station for height and weight with voice guidance

**seca directprint**  
Software module for individual ad hoc assessment of patient

**seca 456**  
seca 360° wireless USB adapter for data reception on PC

**seca | directprint**  
One page printout with your existing printer

Example of seca directprint, version overweight patient.



## Pediatric scales and measuring systems

Exact measurements: as important to life as the air we breathe.

The exact measurement of height and weight is an important prerequisite for a healthy start to life. That is why seca offers everything that makes it easy for nurses and doctors to measure and weigh infants – from a mobile measuring mat to a head circumference tape, and baby scales with a damping function that ensures reliable measurements despite movements.

## Baby scales

Babies who feel safe and secure are easier to weigh.

Baby scales by seca make weighing fast and comfortable, thanks to the skin-friendly materials that immediately take on and radiate body warmth, shapes that make the baby feel safe and intelligent functions that shorten the weighing process. The seca 360° wireless technology allows you to transmit weight measurements wirelessly without cable connections to a PC or printer.

### seca | service

#### For seca 727:

- On-site seca 360° wireless installation service
- Remote or on-site EMR integration service
- Remote or on-site software support



Thanks to the additional measuring tape, the seca 727 enables a precise measurement of the babies' length.



## seca 727

Wireless baby scale with fine 1 g graduation

A special integrated damping system together with the HOLD function for quick, precise weighing even if the baby is restless. The ergonomically shaped tray with high rounded sides makes it easy to weigh larger babies. A new backlit LCD display ensures comfortable reading of the digits, even in dimmed rooms. Power supply is by power adapter or rechargeable batteries. With everything primed for the future and integration in any EMR system, measurements can be transmitted via the seca 360° wireless system.

- Capacity: 44 lbs / 20 kg
- Graduation: 0.1 oz / 1 g < 6 kg > 2 g
- Functions: TARE, HOLD, Auto-HOLD, automatic weighing range switch-over, kg/lbs switch-over, damping, automatic switch-off, SEND/PRINT
- Optional: mobile carts seca 403 and seca 402

**System compatible** with products of the seca 360° wireless system and connects wirelessly to a Welch Allyn Connex® Vital Signs Monitor, Welch Allyn Connex® Spot Monitor or Integrated Wall System.



The new backlit LCD display ensures an easy reading of the digits, even in dimmed rooms.

Can be operated by rechargeable batteries or power adapter.



### Accessories

## seca 403 seca 402

Carts for mobile support of seca baby scales

The seca 403 and seca 402 carts are ideal additions to the seca baby scales seca 727, seca 374, seca 334, seca 354 and seca 354 m. They were specially developed for safe and hygienic routine use in hospitals and medical practices. Customized indentations in the surface accommodate the scale's base and ensure that the scale does not slip out of place. Two practical brakes keep the cart stable so babies can be safely weighed. Also, you can quickly move the baby scale to its required location by pushing or pulling the cart by its handle. The optionally available paper roll holder seca 408 makes the work even more hygienic (seca 402).



The optional measuring rod seca 233 turns the seca 374 into a complete measuring and weighing system.



## seca 374

Digital baby scale with wireless transmission

Ergonomic, convenient and time-saving: these are the key words that define the seca 374. Its extra large tray lets you weigh a seated toddler of up to 44 lbs, even if the child is fidgety. The adjustable damping function combined with the Auto-HOLD function ensures fast and precise work. Net weight of a diapered baby? Choose TARE. The amount of milk breast-fed to a baby? Use the BMIF (Breast-Milk-Intake-Function). Measuring and weighing in one step? Yes – thanks to the optional measuring rod seca 233. Transmit the weight measurement wirelessly to the seca 360° wireless network? Just press SEND. You can do it from any location because the seca 374 is operated by batteries, so there's no need for electrical outlets.

- Capacity: 44 lbs / 20 kg
- Graduation: 0.2 oz < 22 lbs > 0.5 oz / 5 g < 10 kg > 10 g
- Functions: TARE, BMIF, Auto-HOLD, lbs/kg switch-over, damping, automatic switch-off, SEND/PRINT
- Optional: mobile carts seca 403 and seca 402, measuring rod seca 233, head and foot positioners seca 418, switch-mode power adapter seca 400

**System compatible** with products of the seca 360° wireless system and connects wirelessly to a Welch Allyn Connex® Vital Signs Monitor, Welch Allyn Connex® Spot Monitor or Integrated Wall System.

### seca | service

**For seca 374:**

- On-site seca 360° wireless installation service
- Remote or on-site EMR integration service
- Remote or on-site software support



High sides on weighing tray offer special protection from falling out.



With seca 360° wireless technology and the press of a key, the seca 374 can send every measurement to a seca wireless printer or to software seca analytics 115 on the PC.

Power supplied by batteries for mobile use.



### Accessories

#### seca 233

Measuring rod for baby scale seca 374

The measuring rod seca 233 with integrated head and foot positioner turns the seca 374 into a complete measuring and weighing system. A single time-saving step for measuring and weighing is made possible by the easy assembly and effortless read-out of results.

- Measuring range: 14–32" / 35–80 cm
- Graduation: 1/8" / 1 mm



The optional measuring rod allows simultaneous weighing and height measurement.

### Accessories

#### seca 418

Head and foot positioners for seca 374

Easy and convenient: the head and foot positioners seca 418 can easily be attached to the baby scales seca 374. This accessory increases safety by securing baby at head and feet. Integrated handles also make it easier to transport the seca 374.



Head and foot positioners can be easily adjusted for all-around security.



Low weight and practical handle make transport effortless.



## seca 334

Mobile digital baby scale

The easy-to transport seca 334 weighs only 6.2 lbs and requires surprisingly little space. The weighing tray has a generous and comfortable design for babies and toddlers. With the large, clear LCD figures and the practical carrying handle which can be used to hang the scale, makes daily weighing very easy. The Breast-Milk-Intake-Function shows the exact amount of milk the baby has consumed.

- Capacity: 44 lbs / 20 kg
- Graduation: 0.2 oz < 22 lbs > 0.5 oz / 5 g < 10 kg > 10 g
- Functions: TARE, BMIF, Auto-HOLD, lbs/kg switch-over, automatic switch-off
- Battery operated
- Optional: mobile carts seca 403 and seca 402, measuring rod seca 232, head positioner seca 419, switch-mode power adapter seca 400, carrying case seca 428



### Accessories

## seca 232

Measuring rod for baby scale 334

Just as easy to fit as it is to read. This baby measuring rod with integrated head and foot positioner makes the seca 334 even more efficient because now weighing and measuring can be done in one step.

- Measuring range: 14–32" / 35–80 cm
- Graduation: 1/8" / 1 mm



The optional measuring rod allows measuring and weighing in one step.



### Accessories

## seca 428

Carrying case for seca baby scales

The baby scale seca 334 can be safely and efficiently transported in its customized carrying case made of water-repellent material equipped with a shoulder strap and practical padding.



The baby scale can be easily stored and transported.



## seca 354

Digital baby scale also converts to a flat scale for children

Two scales in one! The seca 354 baby scale has a comfortable weighing tray and a fine graduation of 0.5 oz. In no time at all, it can be converted into a floor scale for children with a capacity of 44 lbs. The weighing tray and the base which serves as the floor scale are securely locked together, thus ensuring that the baby can be weighed safely and securely. A further advantage of the scale is its Breast-Milk-Intake-Function which determines how much milk the baby has consumed. The robust but lightweight scale is easy to transport and the user friendly buttons make it easy to operate.

- Capacity: 44 lbs / 20 kg
- Graduation: 0.5 oz < 22 lbs > 1 oz / 10 g < 10 kg > 20 g
- Functions: TARE, BMIF, Auto-HOLD, lbs/kg switch-over, automatic switch-off
- Optional: mobile carts seca 403 and seca 402, measuring board seca 417, Backpack seca 409 (for combination with measuring board or measuring mat), carrying case seca 414 (for combination with measuring board), seca 431 and seca 413

### seca added value

**Baby scales that can also weigh toddlers?** There is such a thing – from seca of course. The high capacity of the seca 354 lets you weigh toddlers and children. Simply remove and set aside the weighing tray for babies and the scale is ready for heavier loads of up to 44 lbs.



The weighing tray can be removed quickly and easily at the touch of a button.



### Accessories

## seca 413

Carrying case for baby scale seca 354

With this case, baby scale seca 354 can be transported comfortably and safely. The exact fit of the seca 413 provides optimum protection and the large opening facilitates the packing and unpacking of the scale. An adjustable shoulder strap makes transport easier and the water-repellent nylon surface keeps everything dry.



To simplify cleaning, weighing tray can be removed.



## seca 725

Mechanical baby scale with sliding weights

This model combines classic design with high-quality precision mechanics. Determining an exact weight is child's play, thanks to the smooth movement of precise sliders. The gently curved weighing tray keeps the baby safe during every step of the weighing process. The resetting function that puts the scale back to zero lets the user reliably determine net weight. Before the baby is weighed, the weight of soft padding in the tray or of the baby's diaper can be deducted from the gross weight with use of the reset-to-zero function. The impact-resistant and scratchproof finish makes it easy to care for the seca 725 and contributes to the scale's guaranteed long service life.

- Capacity: 16 kg
- Graduation: 5 g
- Functions: reset-to-zero function



The reset-to-zero function guarantees reliable determination of net weight by simply deducting the extra weight from adding padding or a diaper.

## Pediatric measuring systems

Adaptable devices are preferred.

Clinics, medical practices and health care facilities face various conditions and requirements. seca responds with a wide range of products for pediatrics. From infantometer to measuring mat and from measuring rod to head circumference measuring tape, seca has the right solution for every application. Whether the devices are for in-patient or mobile use, for everyday or infrequent, seca devices share the renowned seca quality which always lives up to the most demanding medical requirements.



### seca 416

Infantometer for measuring babies and toddlers

The sturdy construction and stability of the infantometer makes it quick and easy to measure babies and toddlers up to two years old. The board is generously designed and the raised and softly rounded sides guide the baby safely into the right position. Permanently mounted with rollers on two guide rails, the footpiece slides smoothly along the scale. Since the footpiece is lockable, the baby can be removed and the result noted later.

- Measuring range: 13–39" / 33–100 cm
- Graduation: 1/16" / 1 mm

#### seca added value

**An infantometer with a lock-in-place footpiece? There is such a thing – from seca of course.**

The footpiece on the infantometer seca 416 smoothly slides into position, but cannot be displaced by baby's stomping feet. With the footpiece firmly in place, you can simply measure and read the results. No more readjustments made necessary by a restless baby.



The foot positioner locks into place to capture results.

The sturdy head piece helps to position the child.

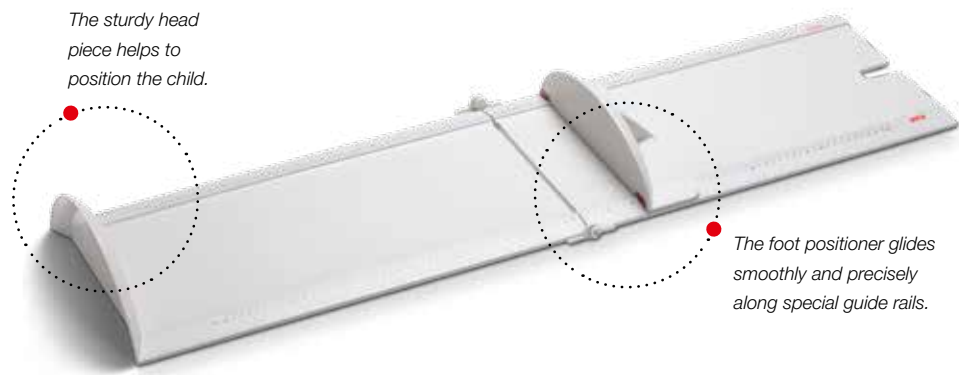

The foot positioner glides smoothly and precisely along special guide rails.

## seca 417

Light, space saving measuring board ideal for mobile use

The seca 417 is lightweight and the convenient fold-up mechanism makes it compact and easy to transport. The removable foot stop is securely guided along rails and the measuring boards smooth surface makes it easy to clean.

- Measuring range: 4–39" / 10–100 cm
- Graduation: 1/16" / 1 mm
- Optional: baby scale seca 354, backpack seca 409 or carrying case seca 414 (each for combination with baby scale) and seca 412



The high-quality folding mechanism guarantees a long service life.



The measurement results are easy to read from the large scale.



### Accessories

#### seca 412

Carrying case for measuring board seca 417



Thanks to its folding mechanism, the mobile measuring board can be stored away compactly and easily transported in this tailor-made carrying case. The robust finish and the durable, water-repellent surface make the bag an indispensable accessory for measuring board seca 417.

### Possible combination

#### seca 354, seca 417 and seca 414

Mobile measuring and weighing system for babies and toddlers

Babies and toddlers have to be measured and weighed regularly to monitor the status and development of their health. Safely stored in the roomy carrying case, the baby and toddler scale can be set up in just a few steps. With a capacity of up to 44 lbs and the infantometer for measurements up to 39 inches, the combination of scale and measuring device make it ideal for examining patients at different locations.



reddot design award

The surface is easy to care for and can be cleaned with all commercially available disinfectants.

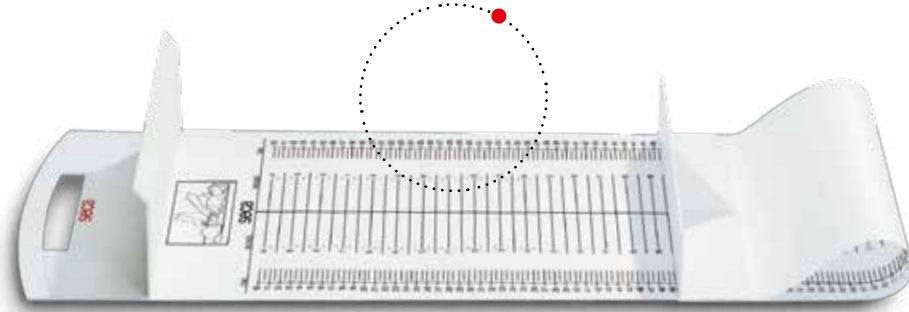

## seca 210

Mobile measuring mat for babies and toddlers

The seca 210 is a lightweight and space-saving solution for precise length measurement of babies and toddlers while lying down. While kind to the skin, the 210 is washable and foldable. The fixed head piece and the sliding foot positioner make it simple to use.

- Measuring range: 4–39" / 10–99 cm
- Graduation: 1/4" / 5 mm
- Optional: backpack seca 409 (for combination with baby scales), carrying case seca 414

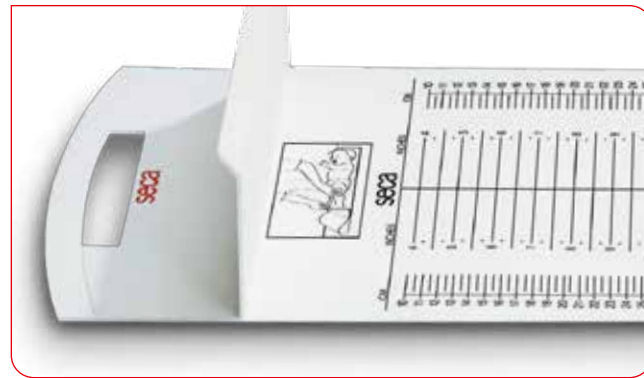

The measuring mat can be rolled up for space-saving storage.



The scale's high-quality printing is also tear-resistant. Measurements are precisely displayed and easy to read even after years of use.

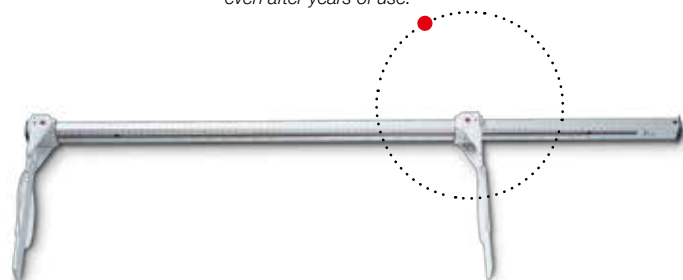

A scale on each side permits measuring of head circumference and facial symmetry.

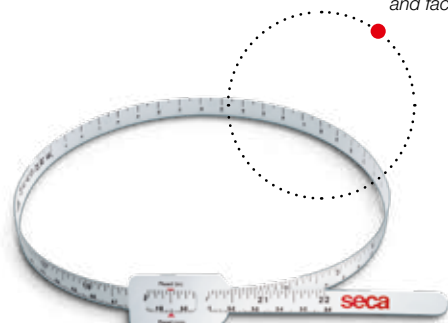

## seca 207

Baby measuring rod with large calipers

For precise measuring when a baby is lying down. The measuring rod can be firmly screwed to the changing table (wall mounting also possible) or used as a mobile rod. Large head and foot positioners make it easy to determine the length and the calipers fold for ease of storage. Made of aluminum for durability.

- Measuring range: 0–39" / 0–99 cm
- Graduation: 1/8" / 1 mm



Movable calipers at one end of the measuring rod make this instrument suitable for use with both babies and toddlers.

## seca 212

Measuring tape for head circumference of babies and toddlers

The measuring tape is made of non-stretch synthetic material and measures both the head circumference (front side) and the symmetry of the face (reverse side). A practical dispenser (containing 15 tapes) ensures that they are stored safely.

- Measuring range: 1–23" / 3–59 cm
- Graduation: 1/16" / 1 mm

 **15 pcs. per unit**



Precise and easy-to-read measurements made possible by clear red markings.



## seca 218

Disposable measuring tape in practical wall dispenser

The environmentally friendly and high-quality disposable measuring tapes simplify your hectic routine work. They can be individually removed from the practical wall dispenser for hygienic use. The wall dispenser is space-saving as well as easy to install and refill.

- Measuring range: 0–100 cm / 0–36"
- Graduation: 1/8" / 1 mm

 **500/1,000 pcs. per unit**



Extra space to write down name, height, weight and date.

Simple refilling of up to 100 measuring tapes.





## seca 211

Disposable measuring tape for head circumference with a practical wall dispenser

The seca 211 measuring tapes are designed to be user-friendly and easy to read with clearly visible measuring points to ensure precise results. The strength of the tape is optimal for easy tearing and refilling. The measuring tapes are recyclable and therefore environmentally friendly. The wall dispenser can be easily installed anywhere.

- Measuring range: 5–23" / 12–59 cm
- Graduation: 1/16" / 1 mm



**500 / 1,000 pcs. per unit**



The seca 211 and seca 218 are available in a pack of 500 (with dispenser) or 1,000 pieces.



## seca 102

Convenient pads for recording child's vital growth information

- Easy reminder for you – record name, visit date, age, height, weight and percentile
- Great take-home for parents
- Record child's growth
- Dimensions: 4 1/4" x 5 1/2"
- Five 100-page pads per pack

### Accessories

## seca 405 (b/g) / seca 406 (b/g) Growth charts

These growth charts for boys (blue) and girls (pink) are the fast, convenient way to track length/height, weight, head circumference and Body-Mass-Index percentiles by age. Plot newborns up to thirty-six months on the seca 405 b or seca 405 g and children from two to twenty years on the seca 406 b or seca 406 g.



100 sheets per pad.

### Accessories

## seca 407 (b/g) Growth charts

New recommendation for breast fed infants based on WHO (World Health Organization) standards. This chart covers up to 24 months.





## Measuring stations and column scales

What can a scale do besides weigh?  
Think.

The measuring stations and column scales by seca are distinguished by high precision and have many features that simplify everyday medical work. Routine procedures are shortened, measuring and weighing are sped up and measurements from some products are wirelessly transmitted to a PC or seca printer with wireless transmission. Thus, doctors and nurses always have the data they need at hand, even the minor details like intuitive operation or easy cleaning of the platforms get a lot of attention at seca.

## The measuring stations by seca measure and weigh in a single step.

The measuring stations by seca are a big help in everyday medical work. Thanks to the combination of measuring rod and scale, height and weight can be digitally obtained in a single procedure. There's no longer any effort involved in figuring out the BMI. Once the patient's height has been confirmed, the BMI appears in the display.

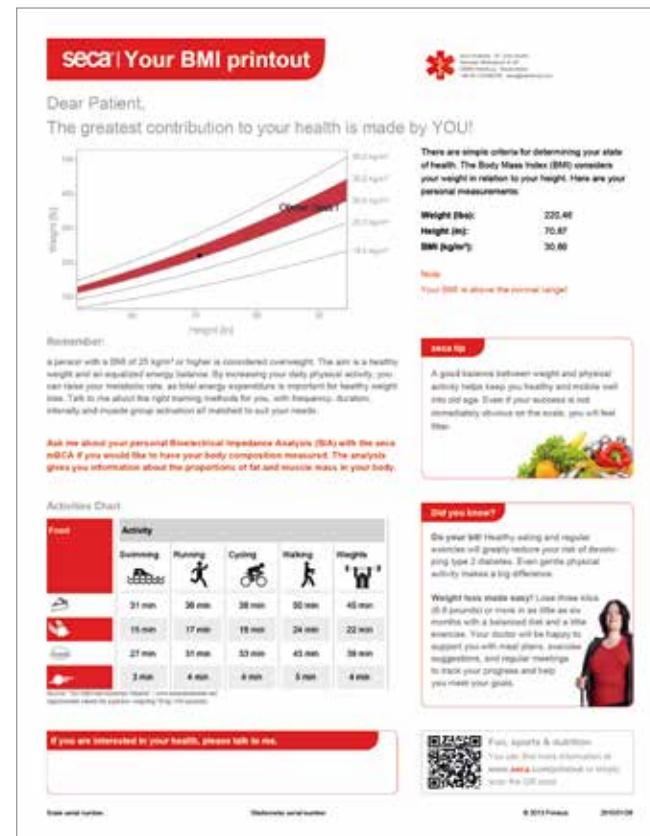

Example of seca directprint patient printout. Dependable data on height, weight and BMI, prepared individually for five different patient types.

### seca | service

#### For seca 286 dp:

- On-site seca 360° wireless installation service
- Remote or on-site EMR integration service
- Remote or on-site software support

## seca 286 dp

Wireless ultrasonic measuring station with directprint function

With the seca 286 dp we have redefined the technical limit of our measuring stations. Three pairs of ultrasonic sensors record the patient's height in milliseconds. The regular Auto-calibration ensures precise results. Everything is calculated using a specially developed digital analysis algorithm that ensures an incomparably high degree of measurement precision. The optional deactivatable voice guidance is programmed for independent measurement so that individual as well as series of measurements can be carried out reliably and precisely. The seca ultrasonic sensors deliver reliably precise measurement results even in continuous operation, whereby the entire measurement is very comfortable due to the silent acoustics. Everything is designed for maximum support of automated measurement: from the voice guidance to the EMR system connection to the practical printout of the measurement results.

#### Scale:

- Capacity: 660 lbs / 300 kg
- Graduation: 0.1 lbs / 50 g
- Functions: Pre-TARE, mother/child-function, HOLD, Auto-HOLD, Auto-BMI, CLEAR, Auto-CLEAR, auto weighing range switch-over, kg/lbs switch-over, damping, SEND/PRINT
- Version: seca 286 dp with directprint function available

#### Length measurement:

- Measuring range: 1 ft 11 5/8" – 6 ft 10 5/8" / 60–210 cm
- Graduation: 1/8" / 1 mm
- Ultrasonic technology: 3 pairs of sensors (3 receivers, 3 transmitters)
- Auto-calibration
- Optional: wireless printer advanced seca 466 and printer holder seca 482, wireless printer seca 465 and printer holder seca 481

- **System compatible** with products of the seca 360° wireless system and connects wirelessly to a Welch Allyn Connex® Vital Signs Monitor, Welch Allyn Connex® Spot Monitor or Integrated Wall System.



Three unique pairs of sensors transmit and receive ultrasonic signals separately and thereby ensure the most precise measurement results.

With the wireless printers seca 466 and seca 465 the measurement results can be immediately printed out or the data can be transmitted directly to an EMR system.

## seca 284 dp

Wireless measuring station with directprint function

seca 360° wireless measuring station seca 284 dp measures and weighs in a single step. Other benefits include the high-capacity scale integrated in a slip resistant glass platform with an anti-tip column design, heel positioner and the solid headpiece with the integrated seca Frankfurt Line – for precise head positioning. The seca 284 dp is equipped with two displays, one is for a direct read-out of height from the headpiece and the other, a three-line multi-function touch display that shows height, weight and the automatically calculated BMI. On top of all that, the scale shows the slightest weight changes with its fine 50-gram graduation and wirelessly transmits all measurements via the seca 360° wireless.

### Scale:

- Capacity: 660 lbs / 300 kg
- Graduation: 0.1 lbs / 50 g
- Functions: Pre-TARE, mother/child-function, HOLD, Auto-HOLD, Auto-BMI, CLEAR, Auto-CLEAR, auto weighing range switch-over, lbs/kg switch-over, damping, SEND/PRINT

### Measuring rod:

- Measuring range: 11"–7 ft 2" / 30–220 cm
- Graduation: 1/8" / 1 mm
- Functions headpiece: HOLD, user-defined zero setting, automatic switch-off, SEND/PRINT
- Optional: wireless printer advanced seca 466 and printer holder seca 482, wireless printer seca 465 and printer holder seca 481

- **System compatible** with products of the seca 360° wireless system and connects wirelessly to a Welch Allyn Connex® Vital Signs Monitor, Welch Allyn Connex® Spot Monitor or Integrated Wall System.

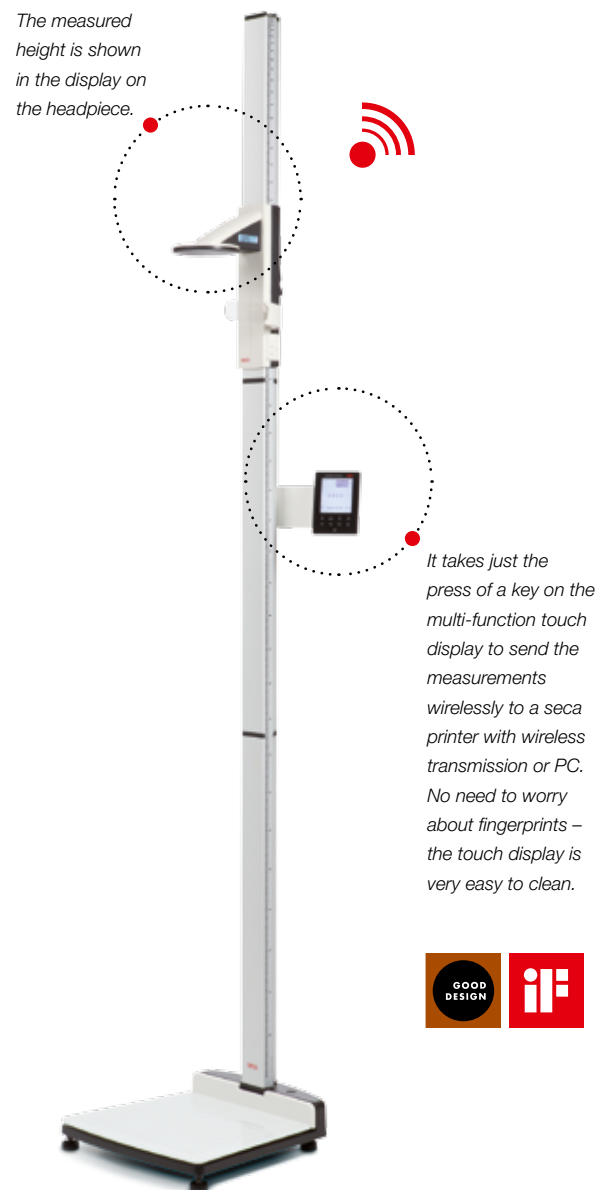

The Frankfurt Line, which is offered only by seca, makes sure the patient's head is in exactly the right position.

The stable glass platform with integrated heel positioner guarantees precise measurement results and a secure foothold.

## seca | service

### For seca 284 dp:

- On-site seca 360° wireless installation service
- Remote or on-site EMR integration service
- Remote or on-site software support

### seca added value

**Height and weight measured, displayed and transmitted together?** There is such a thing – by seca, of course. With the measuring station seca 284 dp, height and weight can be wirelessly transmitted in one step. Along with the automatically calculated BMI, the results are shown in the three-line display. As required, the data can be quickly and securely transmitted wirelessly to a seca printer with wireless transmission or PC.



Obtain an easy-to-read one page printout with your patients measurements.



## seca 763

Digital measuring and weighing station with automatic BMI calculation

With the digital measuring and weighing station seca 763, both the height and weight of a patient can be obtained in just one step. After measuring and weighing, both values are indicated on two LCDs integrated into the display panel. On the basis of these values, the seca 763 automatically calculates the BMI of the patient at the touch of a button. This provides information on the general nutritional condition of the patient on the basis of the recognized WHO standard. With a capacity of 550 lbs, the slip resistant base and anti-tip column design makes measuring and weighing a safe procedure for heavyweight patients.

### Column scale:

- Capacity: 550 lbs / 250 kg
- Graduation: 0.1 lbs / 50 g
- Functions: TARE, HOLD, Auto-BMI, lbs/kg switch-over
- Optional: RS232 interface seca 460

### Integrated Measuring rod:

- Measuring range: 43–79" / 110–200 cm
- Graduation: 1/8" / 1 mm



The scale's low height enables even heavier patients to step effortlessly onto the platform.

Height can be measured digitally with the integrated measuring rod.



The headpiece on the height measuring rod is especially large to ensure correct positioning of the head. Precise measurements are guaranteed.



### Accessories

#### seca 460

RS232 interface for connection to printer or PC

This interface allows the seca 763 measuring station to be connected directly to a PC or printer.



Thanks to the connection between scales and PC or printer, it is easy to analyze and record measurements.



## The column scales by seca

offer a range of solutions to fit your needs.

After more than 177 years, it's nearly impossible to imagine the medical field without seca scales. Thanks to the high precision, durable construction, and robust electronics, it is clear that there are precise details that go into every seca scale. Details like unmatched low energy consumption or smooth-rolling castors, make for effortless transport into the next room.

### seca | service

#### For seca 703:

- On-site seca 360° wireless installation service
- Remote or on-site EMR integration service
- Remote or on-site software support

### seca added value

A column scale that can receive height measurements and then calculate the BMI? There is such a thing – by seca, of course. With the help of the new seca 360° wireless technology, the seca 703 can receive data from a seca stadiometer with wireless transmission (seca 274 or seca 264) and then automatically calculate the BMI from height and weight. Do the results need to be sent wirelessly to a PC or to a seca 360° wireless printer? Yes, and it's as easy as pressing the function key.



## seca 703

High capacity column scale with wireless transmission

From weighing small children to obese patients, the seca 703 can do it all! Especially when it comes to finding out BMI and height. Advantages include a high load bearing capacity of up to 660 lbs, slip resistant cast iron base and anti-tip column design. With everything primed for the future and integration in any EMR system, measurements can be transmitted wirelessly via the seca 360° wireless system.

- Capacity: 660 lbs / 300 kg
- Graduation: 0.1 lbs < 330 lbs > 0.2 lbs / 50 g < 150 kg > 100 g
- Functions: TARE, Pre-TARE, mother/child-function, HOLD, Auto-HOLD, BMI, Auto-CLEAR, lbs/kg switch-over, damping, automatic switch-off, SEND/PRINT
- seca 220 measuring rod included
- Optional: measuring rod seca 224, switch-mode power adapter seca 400

System compatible with products of the seca 360° wireless system and connects wirelessly to a Welch Allyn Connex® Vital Signs Monitor, Welch Allyn Connex® Spot Monitor or Integrated Wall System.



seca 220 measuring rod is included.

The heavy duty cast iron base is slip resistant with a anti-tip column design.



seca 220 measuring rod is included.

Practical castors permit mobile use.



With the seca 360° wireless technology and the press of a key, the seca 703 can send measurements wirelessly to an optional seca digital printer with wireless transmission or seca analytics 115 PC software for diagnostic assistance.

Measure and weigh in just one step – thanks to the integrated measuring rod.



The heavy duty cast iron base is slip resistant with an anti-tip column design.

## seca | service

### For seca 703s:

- On-site seca 360° wireless installation service
- Remote or on-site EMR integration service
- Remote or on-site software support

## seca 703s

Wireless column scale with integrated measuring rod

Measuring and weighing in a single step – that is why the wireless column scale seca 703s was developed. In addition to the patient's weight, the patient's height is also precisely measured with an integrated measuring rod up to 90 inches. The seca 703s automatically determines the BMI from these two values. As part of the seca 360° wireless family, the results can immediately be sent wirelessly to a printer or PC. Intelligent details simplify operation so the display can be operated when the patient is still standing on the scale and reading the measuring rod is easy since printing is displayed on both sides. Using the time-saving TARE function, also known as the mother/child-function in pediatrics, the child can be weighed in its mother's arms without disturbance. The previously stored body weight of the mother is subtracted so that only the weight of the child is obtained. The heel positioner also makes reproducible height measurements possible by means of 3-point measurement.

### Scale:

- Capacity: 660 lbs / 300 kg
- Graduation: 0.1 lbs < 330 lbs > 0.2 lbs / 50 g < 150 kg > 100 g
- Functions: TARE, Pre-TARE, mother/child-function, HOLD, Auto-HOLD, BMI, Auto-CLEAR, damping, kg/lbs switch-over, automatic switch-off, SEND/PRINT
- Optional: switch-mode power adapter seca 400

### Measuring rod:

- Measuring range: 3–90" / 6–230 cm
- Graduation: 1/8" / 1 mm

 **System compatible** with products of the seca 360° wireless system and connects wirelessly to a Welch Allyn Connex® Vital Signs Monitor, Welch Allyn Connex® Spot Monitor or Integrated Wall System.



It's very easy to read the numbers printed on the side.

Practical castors permit mobile use.

## seca 769

Digital column scale with BMI function

Versatile, low-maintenance and site-independent with economic battery operation – the seca 769 is ideal for daily use in hospitals and doctors offices. The seca 769 is equipped with several intelligent functions. For example, the BMI function permits a reliable evaluation of the nutritional condition of the patient. With the slip resistant base and anti-tip column design, patients can be safely measured and weighed. With its transport castors, the column scale is also easy to transport.

- Capacity: 450 lbs / 200 kg
- Graduation: 0.2 lbs / 100 g
- Functions: TARE, HOLD, BMI, lbs/kg switch-over, automatic switch-off
- seca 220 measuring rod included
- Optional: measuring rod seca 224, switch-mode power adapter seca 400



All it takes is the press of a key to find out BMI.

The slip resistant surface with an anti-tip column design guarantees a safe and secure foothold.



seca 220 measuring rod is included.

### Accessories

## seca 224

Side-mounted telescopic measuring rod for seca column scales

This telescopic measuring rod can be mounted on various seca column scales. Its side mounting position allows the measuring device to always be positioned centrally above the head, thus enabling trouble-free measurement.

- Measuring range: 24–78" / 60–200 cm
- Graduation: 1/8" / 1 mm



The optional side-mounted telescopic measuring rod allows simultaneous measuring and weighing.



## seca 700

Mechanical column scale with eye-level beam

With a capacity of 500 lbs, the seca 700 mechanical column scale is an ideal solution for weighing overweight patients. This is due partly to the generously proportioned, low platform. The slip resistant cast iron base and anti-tip column design also allows patients to be safely measured and weighed. The scale is printed on both sides, allowing both patient and nurse to read the weight.

- Capacity: 500 lbs / 220 kg or 400 lbs / 160 kg
- Graduation: 1/8 lbs / 50 g or 1/4 lbs / 100 g
- Functions: reset-to-zero function
- seca 220 measuring rod included



The scale is printed on both sides so that both the patient and the user can read the weight.

The broad slip resistant cast iron base and anti-tip column design provide a firm foothold.



### Accessories

## seca 220

Telescopic measuring rod for seca column scales

This telescopic measuring rod can be fitted at any time to many seca column scales. It has the same convenient eye-level read out for even taller patients.

- Measuring range: 24–78" / 60–200 cm
- Graduation: 1/8" / 1 mm



The measuring rod seca 220 allows convenient weighing and measuring in one step.

## seca 755

Mechanical column scale  
with BMI display

The seca 755 is one of the first mechanical column scales which displays both weight and BMI. Once a patient's weight has been determined, it is easy to locate the BMI range displayed in contrasting colors and categorized by underweight, normal, overweight and obesity. With the slip resistant base and anti-tip column design, patients can be safely measured and weighed.

- Capacity: 350 lbs / 160 kg
- Graduation: 1 lbs / 500 g
- Functions: BMI, reset-to-zero function
- Optional: measuring rod seca 224



It is easy to determine BMI with the color-coded dial.



The separately available measuring rod permits simultaneous measuring and weighing.







### Flat scales

Even space-saving scales do plenty for the patient.

Where space is limited, there is still enough room for seca scales and their many functions. The high weight-bearing capacity of up to 800 lbs and the extremely long usage powered by a battery set simplifies routine medical work. Practical accessories such as carrying cases and a stand for a separate display, make work convenient for the user.

The extra-large platform is easy to step onto and slip proof.

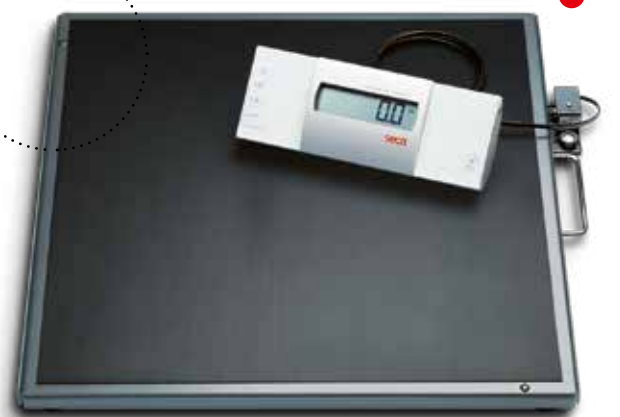

## seca 634

Digital platform and bariatric scale with wireless transmission

Obesity is the fastest growing health problem in the world. This battery-operated digital scale has been especially developed for weighing obese patients, with a weighing range of up to 800 lbs and a non-slip 22 x 22 inch platform, only 2.2 inch high – a sturdy base for overweight or obese patients. A chair may also be used on the scale and will not influence the weighing result due to the Pre-TARE function. The cable remote display (cable length: 98.4 inch) with easy-to-read LCD can be held, wall mounted or placed on a table. The 0.1 lbs graduation means that the smallest changes in weight are registered, even after the patient has left the scale – thanks to the Auto-HOLD function. The integrated Body Mass Index (BMI) function and the seca 360° wireless technology, which can be used to transmit the measurements to a seca wireless printer or PC at the push of a button emphasizes the many uses of this unique multifunctional scale.

- Capacity: 800 lbs / 360 kg
- Graduation: 0.1 lbs / 50 g
- Functions: TARE, Pre-TARE, HOLD, Auto-HOLD, BMI, Auto-CLEAR, lbs/kg switch-over, damping, automatic switch-off, SEND/PRINT
- Optional: stand for cable remote displays seca 472, switch-mode power adapter seca 400

**System compatible** with products of the seca 360° wireless system and connects wirelessly to a Welch Allyn Connex® Vital Signs Monitor, Welch Allyn Connex® Spot Monitor or Integrated Wall System.

### seca | service

#### For seca 634:

- On-site seca 360° wireless installation service
- Remote or on-site EMR integration service
- Remote or on-site software support

#### seca added value

**Flat scales for heavy weight patients with a separate display element?** There is such a thing – from seca of course. It is the platform and bariatric scale seca 634. The advantage of the mobile display provides medical staff with the ability to read the results from any location – discreetly and conveniently at a desk, at eye-level on the wall or from a stand in the middle of the room.



The patient's BMI can be determined when their height is entered.

It's easy to step onto the extra large, slip proof platform.

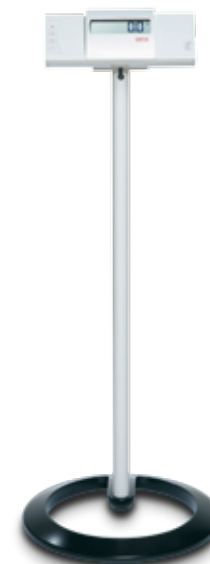

### Accessories

## seca 472

Stand for cable remote display of seca scales

The seca 472 stand is the stable solution for cable remote displays of the seca 634, seca 656 and seca 674 scales. The sturdy construction with non-slip steel feet can be positioned anywhere quickly and securely. The display element can easily be attached to the stand by means of a stable bracket.



With padded sides for completely safe transportation.

### Accessories

## seca 421

Carrying case

This carrying case is made from water-repellent material to allow safe transportation of the seca 869 flat scale. The handy side pocket also allows safe transportation of a cable remote display or other accessories.

The integrated handle and low weight make these scales easy to transport.

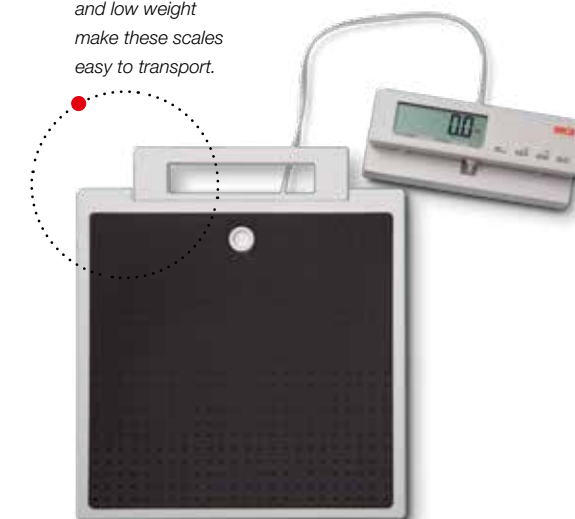

## seca 869

Flat scale with cable remote display

A 6.5 foot cable connects the display with the weighing base. Advantage: the display can be set up separately from the base and read from its position on the wall or desk. Additional convenience is supplied by the many extra weighing functions: BMI for nutritional conditions, HOLD to keep measurements displayed and TARE for weighing small children held in an adult's arms. It is suitable for stationary or mobile use thanks to its handle, compact size, and sturdy leveling base for set-up on all types of surfaces.

- Capacity: 550 lbs / 250 kg
- Graduation: 0.2 lbs < 330 lbs > 0.5 lbs / 100 g < 150 kg > 200 g
- Functions: TARE, HOLD, BMI, lbs/kg switch-over, automatic switch-off
- Optional: stadiometer seca 217 combined with adapter element seca 437, backpack seca 409 or carrying case seca 414 (for combination with stadiometer and adapter element), seca 421 and switch-mode power adapter seca 400



The angle of the display can be adjusted for easy reading and can be used separately from the base.



Both doctor and patient can see the result at the same time in the double display.

## seca 874

Flat scale for mobile use with push buttons and double display

The seca 874 can do everything that a scale in mobile use should do and more. It is light, extremely robust, easy to operate, provides precise measurements in any level of humidity and has a long battery life. When conducting one examination after the other, there's no need to bend over repeatedly, thanks to the push button that can be turned on and off with a toe tap. The double display lets the patient and medical personnel read the results from two different aspects at the same time. Thanks to the 2 in 1 button, the scale can weigh a child held in its parent's arms.

- Capacity: 440 lbs / 200 kg
- Graduation: 0.1 lbs < 330 lbs > 0.2 lbs / 50 g < 150 kg > 100 g
- Functions: mother/child-function, Auto-HOLD, lbs/kg switch-over, automatic switch-off
- Battery-operated
- Optional: stadiometer seca 217 combined with adapter element seca 437, backpack seca 409 or carrying case seca 414 (for combination with stadiometer and adapter element) and seca 415



The two push buttons on the front side of the scale can be operated with the foot.



### Accessories

## seca 409

Backpack for varied use

Those who transport their devices as a mobile nurse or midwife have clear material requirements. The multifunctional backpack seca 409 was therefore developed out of high-quality and water-repellent materials in cooperation with UNICEF. Wide, padded shoulder straps and carrying handles made it comfortable to carry and guarantee a high amount of comfort even on longer trips. Baby scales, flat scales, or measuring boards can thereby be transported easily and especially safe in various possible combinations.

### seca added value

**A mobile measuring and weighing system?** There is such a thing – from seca of course. With the addition of the adapter element seca 437 for the measuring rod seca 217, the flat scale seca 874 turn into a mobile and very stable 2-in-1-solution. Measuring and weighing can be done at the same time – with the same quality as with permanently installed equipment. When stored in the carrying case seca 414, the mobile measuring and weighing system can be used anywhere.



### Possible combination

## seca 874, seca 217, seca 437 and seca 414

Mobile measuring and weighing system for schoolchildren and adults

To determine height and weight of school children and adults in a standing position, a special adapter element turns the stadiometer and flat scale into a perfect measuring and weighing station. It delivers two measurements in one step – with the same quality found in hospitals. Even though the elements are lightweight and easily assembled, the system is extremely stable and warp-resistant. Almost like a permanent installation.



The low weight of only 4.2 kilograms makes mobile use possible.

## seca 876

Flat scale for mobile use

Scales intended for mobile use have to be lightweight. The compact seca 876 weighs only 9.3 lbs, nevertheless very stable and suitable for patients weighing up to 550 lbs. It stands firmly on four leveling bases that guarantee stability, even when small children are weighed while held by an adult. The mother/child-function determines the tare of the weight with just the touch of a button.

- Capacity: 550 lbs / 250 kg
- Graduation: 0.2 lbs < 330 lbs > 0.5 lbs / 100 g < 150 kg > 200 g
- Functions: mother/child-function, lbs/kg switch-over, tap-on automatic switch-on, automatic switch-off
- Optional: stadiometer seca 217 combined with adapter element seca 437, backpack seca 409 or carrying case seca 414 (for combination with stadiometer and adapter element) and seca 415



Tip-on function for weighing without turning on the scale.

The custom label serves to provide individual personalization.



new

## seca 874 dr

Doctor's scale with customizable label

The design and the name speak a common language. The seca 874 dr is the new flat scale standard for doctors in medical practices. Your advantages include the foot-operated on/off switch and the user-friendly dual LCD display that can be read simultaneously by doctor and patient. Weighing children is simplified by activation of the mother/child-function. The specially developed doctor's scale, which is subject to very strict quality requirements in its manufacture, reliably delivers accurate data. With top quality and medical precision combined in a compact, modern design, the seca 874 dr is perfectly aligned to the needs of today's medical practices.

- Capacity: 440 lbs / 200 kg
- Graduation: 0.1 lbs < 330 lbs > 0.2 lbs / 50 g < 150 kg > 100 g
- Functions: mother/child-function, Auto-HOLD, automatic switch-off
- Battery-operated or using power adapter
- Optional: customizable label seca 478 at [www.seca.com/doctorscale](http://www.seca.com/doctorscale)



The two buttons on the front side of the scale can be easily operated by foot.

Accessories

## seca 415

Carrying case



This practical carrying case can be used to safely transport the flat scales seca 874, seca 876 and seca 803.



The extra-wide surface, 15.7 x 1.8 x 11.8 inch, and the flat shape facilitate trouble-free weighing of heavyweight patients.



Thanks to the 1.1 inch LCD figures, the weights in the display are easy to read.



The face of the dial is especially large to make reading the figures much easier.



The stable material on the platform ensures safety from slippage.



## seca 813

High capacity digital flat scale for individual patient use

seca has designed the seca 813 with a high capacity of up to 440 lbs and an extra wide platform. The tough rubber mat ensures a secure stance and flat construction allows for easy accessibility.

- Capacity: 440 lbs / 200 kg
- Graduation: 0.2 lbs / 100 g
- Functions: Auto-HOLD, step-off, lbs/kg switch-over, tip-on automatic switch-on, automatic switch-off

## seca 803

Digital flat scale for individual patient use

The classic, clean line of the basic model turns heads and the high-quality rubber coating feels good to the touch. It's also pleasantly easy to read the weights in the display because the large LCD figures.

- Capacity: 330 lbs / 150 kg
- Graduation: 0.2 lbs / 100 g
- Functions: Auto-HOLD, lbs/kg switch-over, tip-on automatic switch-on, automatic switch-off
- Optional: carrying case seca 415



Even the basic model is complex in design and robustly ribbed for a secure stance during the weighing process.

## seca 762

Mechanical personal scale with fine 1 lbs graduation

The precise, classic design has a large clear and well-defined dial with a graduation of 1 lbs. With a large, low-level, non-slip platform and scratch resistant finish, it is easy for the patient to access and weigh.

- Capacity: 320 lbs / 150 kg
- Graduation: 1 lbs / 500 g
- Functions: reset-to-zero function



The rugged metal housing withstands years of use under the hardest conditions imaginable.

## seca 750

Robust mechanical floor scale

Pretty and stable: with a pure, light design this scale will make a great impression in any facility. A stable, powder-coated steel casing, a circular display and an easy-to-clean tread area of imitation leather – what more does one need for comfortable weighing? The seca 750 is available in three versions: kilograms, pounds and kilograms/pounds.

- Capacity: 320 lbs / 150 kg
- Graduation: 1 lbs / 1 kg, 1 lbs, 1 kg
- Functions: reset-to-zero function



The housing consists of metal treated with powdercoated lacquer.



## Height measuring systems

When the quality is right,  
so are the measurements.

**M**easuring rods and circumference measuring tapes are relatively simple devices in routine medical work – they still have to fulfill challenging clinical requirements. That's why seca produces such items as non-abrasive measurement scales and parts made of distortion-resistant anodized aluminum. For quality you can feel – in devices that wirelessly transmit your data at the touch of a button into the seca 360° wireless network and in headpieces that always glide smoothly into position. seca guarantees you consistent and precise measurements.

## seca 274

Digital mobile stadiometer with wireless transmission

If you are looking for a wireless solution for taking height measurements, you cannot go wrong with the free-standing digital stadiometer seca 274. Its individual parts of high-quality aluminum can be easily assembled and tightly screwed together and its measuring range from 11 inch – 7 ft 2 inch can be used for small children to adults. Additional benefits include a slip resistant glass platform and anti-tip column design, white backlit display on the headpiece and wireless data transmission. Data can be sent wirelessly to a seca digital printer with wireless transmission, a PC or a seca scale with wireless transmission that can calculate the BMI from height and weight measurements.

- Measuring range: 11" – 7 ft 2" / 30–220 cm
- Graduation: 1/8" / 1 mm
- Functions: HOLD, inch/cm switch-over, user-defined zero setting, automatic switch-off, SEND/PRINT

**System compatible** with products of the seca 360° wireless system and connects wirelessly to a Welch Allyn Connex® Vital Signs Monitor, Welch Allyn Connex® Spot Monitor or Integrated Wall System.

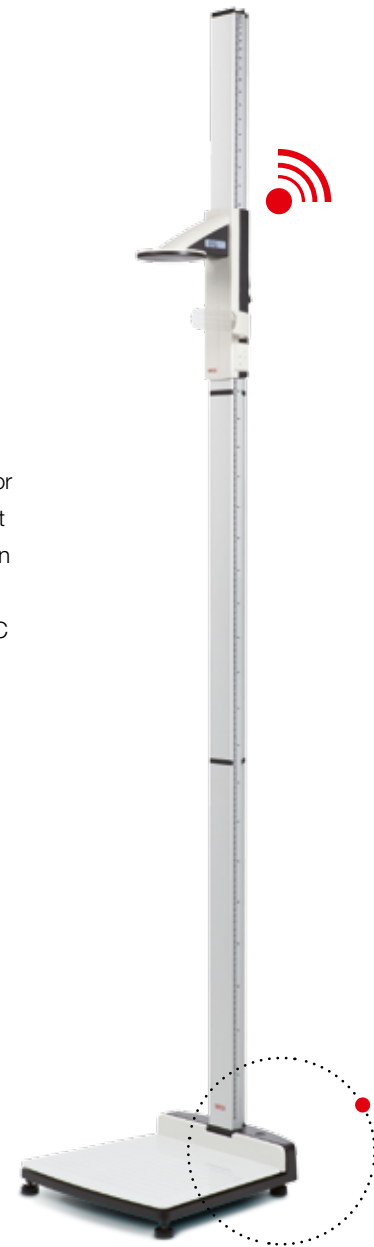

*The stable glass platform of the seca 274 with integrated heel positioner guarantees precise measurement results and a secure foothold.*

### seca added value

A stadiometer that can wirelessly transmit its measurements to a PC? There is such a thing – from seca of course: the digital stadiometer seca 274 (free-standing) and seca 264 (for wall mounting). Both transmit the measured height with the help of the newest seca 360° wireless technology to the PC, where they are analyzed by the PC software seca analytics 115. From there they can also be transmitted to an Electronic Medical Record (EMR) system.



*With the patient's head precisely positioned, the seca Frankfurt Line guarantees exact measurements.*

*The leveling feet allow firm footing, even on uneven surfaces.*

## seca 264

Digital stationary stadiometer with wireless transmission

The goal of accomplishing more in fewer steps is as important in medicine as in other fields. The stadiometer seca 264 helps make that possible. For example, the heel positioner and the seca Frankfurt Line on the headpiece ensure that the patient is in the right position and thereby contribute to obtaining accurate measurements. Height measurements can be read with a quick glance at the white backlit display on the headpiece. Wireless data transmission is made to a seca digital printer with wireless transmission, a PC or a wireless scale.

- Measuring range: 11" – 7 ft 2" / 30–220 cm
- Graduation: 1/8" / 1 mm
- Functions: HOLD, inch/cm switch-over, user-defined zero setting, automatic switch-off, SEND/PRINT

**System compatible** with products of the seca 360° wireless system and connects wirelessly to a Welch Allyn Connex® Vital Signs Monitor, Welch Allyn Connex® Spot Monitor or Integrated Wall System.



*The white backlit display on the headpiece is very easy to read.*

*The easy-to-clean mat of the seca 264 puts the patient's feet in the right position and gives the barefoot patient a safe and comfortable footing.*

### seca | service

**For seca 274 and seca 264:**

- On-site seca 360° wireless installation service
- Remote or on-site EMR integration service
- Remote or on-site software support

## seca 217

Stable stadiometer for mobile height measurement

The mobile stadiometer seca 217 boasts unmatched stability, a cleverly designed assembly system and particularly high-quality materials. All this lends the stadiometer an exceptionally high degree of stability – almost the same as a permanent installation. In addition, the adjustable spacer ensures a secure hold without any fittings. Suitable for medical practices and hospitals, the stadiometer is also just right for mobile use, such as examinations of children at school or patients at home. When disassembled, the stadiometer is easy to transport.

- Measuring range: 8" – 81" / 20–205 cm
- Graduation: 1/8" / 1 mm
- Optional: adapter element seca 437 (for combination with flat scale seca 869, seca 874 or seca 876), backpack seca 409, carrying case seca 414 or seca 412



The spacer provides extra stability and ensures precise measurement results.



The robust base plate guarantees a sturdy stance.



The seca 437 adapter element connects the stadiometer to a flat scale.

## seca 213

Portable stadiometer

At only 5.3 lbs, the seca 213 mobile stadiometer is especially suitable for use in the field but also ideal for doctors' practices and pediatric hospitals. The measuring rod can be dismantled into several pieces and set up easily and quickly. The spacer keeps the rod straight and stable without any fittings. As the scale is printed along the side of the measuring rod, it is easy to read off the result while measuring, thus guaranteeing precise results – up to a height of 81 inches.

- Measuring range: 8" – 81" / 20–205 cm
- Graduation: 1/8" / 1 mm
- Optional: carrying case seca 412

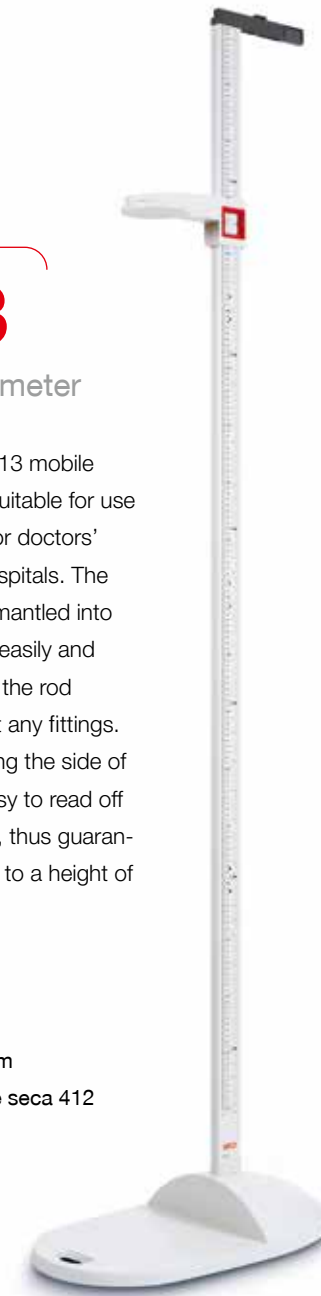

The integrated handle and securely locking parts make the stadiometer easy to carry.



Large platform for stability.

## seca 222

Mechanical telescopic measuring rod with large measuring range

Specially developed for wall mounting, this measuring rod is aligned to work exactly to the millimeter from head to toe. Its broad measuring slide and heel positioner are professional prerequisites. The telescopic measuring rod ensures that the result can be easily read at eye level even for the tallest patient. When not in use, the measuring slide can be folded down for safety.

- Measuring range: 2–90" / 6–230 cm
- Graduation: 1/8" / 1 mm

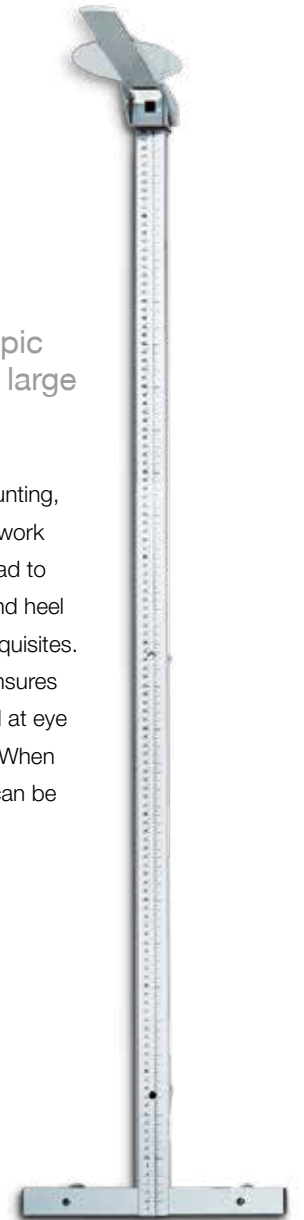

The foot positioner ensures exact positioning and precise measurements.





## seca 216

Mechanical measuring rod for children and adults

The seca 216 has a variable scale with a range of 1.4 to 90 inches that is inserted into a 55.3 inch frame. The plastic frame is easily mounted on the wall at the desired height. As the user can choose the range shown in the frame, the seca 216 is suitable for measuring children or adults. The results are clearly displayed in a window on the side of the rod and held in place by the locking screw on the head piece. Suitable for international use, the scale is printed in centimeters on one side of the tape and centimeters and inches on the other.

- Measuring range: max. 55.3" / 138 cm, variable from 1.4–90" / 3.5–230 cm
- Graduation: 1/16" / 1 mm



Whether for children or adults – the measuring range can be adjusted as needed.

The graduation index can be fixed in place with the locking screw.

The wall mounting of the measuring tape with roll mechanism reduces space requirements drastically.



## seca 206

Mechanical measuring tape

The space-saving solution with roll-up mechanism. Uncomplicated fixing on wall with just one screw. With the display window in the head piece, it's easy to read the height. The durable tape is made of metal.

- Measuring range: 0–87" / 0–220 cm
- Graduation: 1/8" / 1 mm



This high-quality scale made of metal is intended for longterm use.

## seca 203

Ergonomic circumference measuring tape with extra Waist-To-Hip-Ratio calculator (WHR)

The measuring tape seca 203 for determination of body circumference has a highquality scale of metal used to obtain the Waist-To-Hip-Ratio (WHR). The WHR is an indirect method of determining the amount of abdominal fat tissue. The ratio allows conclusions to be drawn about the distribution of fat stores and thus contributes to a diagnosis.

- Measuring range: 0–80" / 0–205 cm
- Graduation: 1/8" / 1 mm
- Function: WHR calculator



## seca 201

Ergonomic circumference measuring tape

Today's circumference tapes also have to satisfy high medical demands. That is why seca has developed the seca 201 which can measure girth with millimeter precision. The high-quality mechanics guarantee that the 80 inch long tape unwinds easily and locks in place precisely. The housing sits comfortably and securely in the user's hand and is tough enough to withstand accidental dropping.

- Measuring range: 0–80" / 0–205 cm
- Graduation: 1/8" / 1 mm

seca added value

A measuring tape with two functions? There is such a thing – from seca of course. The ergonomic measuring tape seca 203 also has a scale that determines the Waist-To-Hip-Ratio (WHR). With a single measuring instrument you can determine body circumference and get diagnostic data about health risks, such as details about the distribution of body fat.





## Multifunctional and wheelchair scales

Effortless for the patient, convenient for medical staff.

**W**eighing can be a complicated process, but it doesn't have to be. The multifunctional and wheelchair scales by seca are easy-to-use whether the patient is sitting in a wheelchair or standing. Four load cells ensure that a patient can be measured regardless of position – standing without support or holding onto the handrail, in the middle of the scales or at the edge. There is no need for careful positioning of the patient or adjustments to the scales. Emphasis is on convenient operation with wireless transmission of data to a PC, a seca digital printer with wireless transmission, and seca analytics 115 medical PC software.

## seca 644

Digital multifunctional handrail scale with wireless transmission

Equipped with an extremely low-level, easy-access platform, a stable handrail, and high weight-bearing capacity, this multifunctional scale ensures safe and comfortable weighing of heavy patients. The integrated handrail provides the patient with support throughout the weighing process – or a chair can be placed on the generous platform for the patient to sit in. The Pre-TARE function with three memory cells automatically deducts a stored weight (such as a chair) to determine net weight. The seca 644 is also equipped with seca 360° wireless technology which can be used to transmit the measurement results wirelessly to a seca digital printer with wireless reception or the seca software on a PC. In addition, the device is made mobile by two rubber wheels and a power supply provided by rechargeable batteries or power adapter. When the scale is connected to a printer, the time of weighing and the patient's weight are automatically recorded and printed by the time module.

- Capacity: 800 lbs / 360 kg
- Graduation: 0.1 lbs / 50 g
- Functions: TARE, Pre-TARE, HOLD, Auto-HOLD, BMI, Auto-CLEAR, kg/lbs switch-over, damping, automatic switch-off, SEND/PRINT
- Optional: measuring rod seca 223

**System compatible** with products of the seca 360° wireless system and connects wirelessly to a Welch Allyn Connex® Vital Signs Monitor, Welch Allyn Connex® Spot Monitor or Integrated Wall System.

### seca | service

#### For seca 644:

- On-site seca 360° wireless installation service
- Remote or on-site EMR integration service
- Remote or on-site software support



#### Accessories

### seca 223

Telescopic measuring rod for handrail scales

This easy-to-fit measuring rod (fittings included) converts the handrail scale seca 644 into a real all-round talent. The determined height can be entered directly into the control unit of the seca 644 so that all relevant data is captured and used to determine the BMI.

- Measuring range: 2–90" / 6–230 cm
- Graduation: 1/8" / 1 mm



The optional measuring rod permits measuring and weighing in one step.



The display can be rotated in every direction.

Because the handrail is part of the weight sensitive area, measurements are absolutely certain even if the patient supports himself on it.

## seca 684

Wireless multifunctional scale

The patient can be safely and accurately weighed while standing, seated or in a wheelchair. No conversion is required. The stable handrail supports the standing patient, the integrated fold-down seat provides comfort for the seated patient, and the large platform (31.5 x 33.1 inch) accommodates a patient in a wheelchair. The weight of the wheelchair or walker is simply deducted with use of the Pre-TARE function. Special attention has been given to making the scales easy to access and safe, with a stop barrier provided for the front wheels of the wheelchair. Furthermore, the seca 684 is equipped with the new seca 360° wireless technology, which wirelessly transmits all measurements to a seca wireless printer or to seca software on a PC. Additional details: easy-to-read swiveling display can be turned toward patient or caregiver, the practical HOLD function shows the weighing result after the patient has left the platform, the damping function ensures precise results, the non-slip rubber coating and handrail guarantee a firm foothold and integrated transport castors make the scale mobile.

- Capacity: 800 lbs / 360 kg
- Graduation: 0.1 lbs / 50 g
- Functions: TARE, Pre-TARE, HOLD, Auto-HOLD, BMI, Auto-CLEAR, kg/lbs switch-over, damping, SEND/PRINT
- Version: seca 684 r with integrated RS232 interface
- Optional: PC interface cable seca 451 (only for seca 684 r)

**System compatible** with products of the seca 360° wireless system and connects wirelessly to a Welch Allyn Connex® Vital Signs Monitor, Welch Allyn Connex® Spot Monitor or Integrated Wall System.



#### Accessories

### seca 451

PC interface cable for the multifunctional and wheelchair scales seca 684 r and seca 676 r

The optionally available PC interface cable seca 451 (female) guarantees a reliable transmission of height and weight between a seca scale and the PC.



Patient can stand or sit when being weighed.

The rotating display can be oriented towards the patient or medical personnel.

## seca 676

Digital wheelchair scale with handrail and wireless transmission

Stable, functional and mobile: thanks to its large platform and sturdy handrail, the seca 676 is extremely versatile. Patients can be weighed while sitting in a wheelchair or on a chair. The handrail provides valuable support for people who are frail or have difficulty walking. Its high load capacity makes the seca 676 ideal for weighing very heavy patients. After use the scale can be folded together to save space. The sturdy locking device between rail and platform ensures that the seca 676 stands safely even when folded. The handrail also serves as handle when the scale is folded, allowing the scale to be moved around or stowed away effortlessly and quickly on its transport castors. Weighing is simple and user-friendly with the clearly designed, operable display at hip level, additional functions of TARE, Auto-HOLD, BMI and the SEND key to transmit measurements wirelessly to a seca digital printer with wireless reception or the PC.

- Capacity: 800 lbs / 360 kg
- Graduation: 0.1 lbs / 50 g
- Functions: TARE, Pre-TARE, HOLD, Auto-HOLD, BMI, Auto-CLEAR, lbs/kg switch-over, damping, SEND/PRINT
- Two ramps included
- Version: seca 676 r with integrated RS232 interface
- Optional: PC interface cable seca 451 (only for seca 676 r)

- **System compatible** with products of the seca 360° wireless system and connects wirelessly to a Welch Allyn Connex® Vital Signs Monitor, Welch Allyn Connex® Spot Monitor or Integrated Wall System.

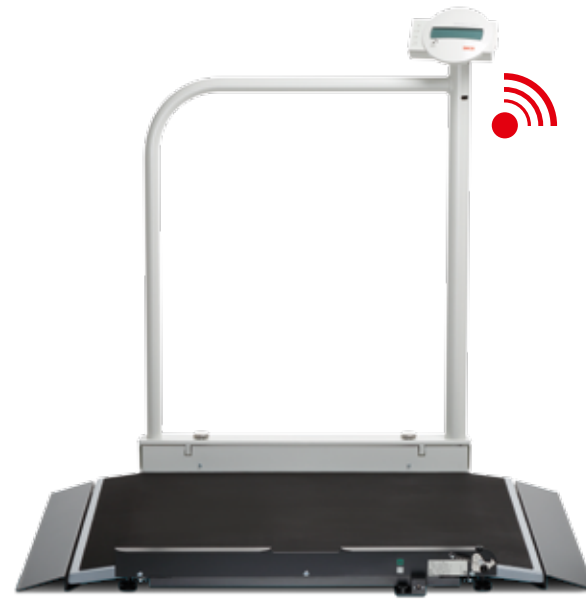

### seca | service

#### For seca 676 and seca 664:

- On-site seca 360° wireless installation service
- Remote or on-site EMR integration service
- Remote or on-site software support

#### seca added value

**A handrail for support that doesn't falsify the measurement?** There is such a thing – from seca of course. The handrail not only provides the patient with security, but provides accurate measurements when the patient leans on or holds onto the handrail.



The scale can be folded for easy mobility.



## seca 664

Digital wheelchair scale with wireless transmission

With its high capacity of 800 pounds, the seca 664 makes it easy to weigh even heavyweight. Easy access is assured by its extremely low platform and the self lowering ramps. The secure side rails give additional safety. An integrated Pre-TARE function determines in seconds the net weight of the patient by utilizing internal weight memory. All the data can be transmitted wirelessly to a seca printer or PC immediately after weighing. The swiveling LCD with large letters is easy-to-read both for the patient and for the caregiver. The seca 664 can be folded up in no time and can be transported anywhere, thanks to its roller castors.



- Capacity: 800 lbs / 360 kg
- Graduation: 0.1 lbs / 50 g
- Functions: TARE, Pre-TARE, HOLD, Auto-HOLD, BMI, Auto-CLEAR, lbs/kg switch-over, damping, automatic switch-off, SEND/PRINT
- Two ramps included
- **System compatible** with products of the seca 360° wireless system and connects wirelessly to a Welch Allyn Connex® Vital Signs Monitor, Welch Allyn Connex® Spot Monitor or Integrated Wall System.



The seca 664 simply folds up and moves easily across the floor on castors.

The platform's side rails keep a wheelchair safe and secure.

With its transport castors and steering castor, the seca 656 can be maneuvered easily.



## seca 656

High capacity digital stretcher scale with wireless transmission

The extra large platform of the seca 656 makes it possible to weigh patients on all commonly used stretchers. Patients can also be weighed while sitting in wheelchairs or on a chair. A unique characteristic of the seca 656 is the memory function. This practical feature helps to lighten the workload especially in the emergency unit: first the total weight of the patient and stretcher or wheelchair is determined. The stretcher or wheelchair is then weighed separately and the net weight of the patient appears automatically on the display. A cable remote display with easy-to-read LCD figures is included in delivery. This display is operated intuitively and is equipped with many additional functions. With the Pre-TARE function, the extra weight of a stretcher or wheelchair can be deducted directly from the total weight during the weighing process. With the BMI function, the nutritional condition of the patient can be determined. Thanks to its robust design and capacity of 800 lbs, the seca 656 can weigh even overweight persons with no problem at all. With the practical castors and integrated handles, the seca 656 is also transportable for use in various locations.

And with the seca 360° wireless technology, the measurements can be sent to a seca wireless printer or the PC at the push of a button.

- Capacity: 800 lbs / 360 kg
- Graduation: 0.1 lbs / 50 g
- Functions: TARE, Pre-TARE, HOLD, Auto-HOLD, BMI, Auto-CLEAR, lbs/kg switch-over, damping, SEND/PRINT
- Optional: Stand for cable remote displays seca 472
- Two ramps included

- **System compatible** with products of the seca 360° wireless system and connects wirelessly to a Welch Allyn Connex® Vital Signs Monitor, Welch Allyn Connex® Spot Monitor or Integrated Wall System.

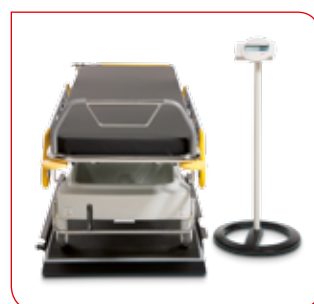

The free-standing display guarantees comfortable read-out of measurements.

### seca | service

**For seca 656:**

- On-site seca 360° wireless installation service
- Remote or on-site EMR integration service
- Remote or on-site software support



A ramp for easy roll-on of wheelchairs is included in delivery.

## seca 674

High capacity digital platform scale with transport castors

This generously-sized wheelchair/platform scale is multifunctional. It weighs patients in care, especially heavy patients, persons in wheelchairs and seated patients with circulatory trouble, even during dialysis. The flexible cable remote display can be placed anywhere (e.g. on a desk or table) for convenient read-out and operation of the controls. Wall mount included. Transport castors and a handle make the seca 674 mobile.

- Capacity: 800 lbs / 360 kg
- Graduation: 0.1 lbs / 50 g
- Functions: TARE, Pre-TARE, HOLD, Auto-HOLD, BMI, Auto-CLEAR, lbs/kg switch-over, damping
- Optional: Stand for cable remote displays seca 472, second ramp seca 470
- One ramp included



### Accessories

#### seca 472

Stand for cable remote displays of seca scales

The seca 472 stand is the stable solution for cable remote displays of the seca 634, seca 656 and seca 674 scales. The sturdy construction with non-slip steel feet can be positioned everywhere quickly and securely. The display element can easily be attached to the stand by means of a stable bracket.

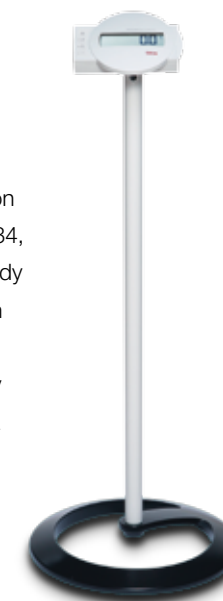

### Accessories

#### seca 470

Second ramp for seca 674

Optional accessory: this ramp for platform scale seca 674 makes it even easier to get onto the scale with a wheelchair from both sides.



Thanks to the ramp, a wheelchair rolls easily and comfortably onto the platform.

## Chair scales by seca

Competence takes the chair.

How can you gently and carefully weigh bedridden patients or people who are unsteady on their feet? The best choice is a seca chair scale, which you can take directly to the patient. That saves you – and nursing staff – from unnecessary steps. And with the scale's wireless function, transmission of data to a printer or a PC is quick and easy.

### seca | service

#### For seca 954:

- On-site seca 360° wireless installation service
- Remote or on-site EMR integration service
- Remote or on-site software support

## seca 954

Digital chair scale with wireless transmission

Care and comfort were kept in mind when designing the stable model with a circular steel tube frame. The comfortable seat provides a safe position while the swiveling armrests and adjustable footrests make the chair scale more user-friendly. The locking rear wheels ensure that it is safe to sit down and stand up at all times. The positioning of the large LCD display unit behind the chair permits intuitive operation of functions TARE, HOLD and BMI. At the press of a button, the seca 360° wireless technology transmits measurements to a seca digital printer with wireless reception or a PC. This mobile chair scale, which can be operated by a rechargeable battery, provides enormous help in rehab, orthopedics, dialysis, nursing homes and pediatrics. The practical pouch seca 471 attached to the scale frame stores the power adapter.

seca 954



With its exceptionally high capacity of up to 660 lbs, the BMI function and options to use mains or battery power, the chair scale seca 954 are ideal for use in any situation.

seca 952



The seca 952 can be run on batteries instead of mains power, and offers a capacity of 440 lbs.



seca 954

- Capacity: 660 lbs / 300 kg
- Graduation: 0.1 lbs < 330 lbs > 0.2 lbs / 50 g < 150 kg > 100 g
- Functions: TARE, Pre-TARE, HOLD, Auto-HOLD, BMI, Auto-CLEAR, lbs/kg switch-over, damping, automatic switch-off, SEND/PRINT

- **System compatible** with products of the seca 360° wireless system and connects wirelessly to a Welch Allyn Connex® Vital Signs Monitor, Welch Allyn Connex® Spot Monitor or Integrated Wall System.



seca 954

seca 954 / seca 952

The supplied carrying case provides space to store the power supply cable together with the scale.

The armrests can also be folded away to allow patients better access from the side.



seca 952

## seca 952

Chair scale for weighing while seated

With a capacity of 440 lbs and a graduation of 0.2 lbs, the seca 952 fulfills all basic medical standards. Added to that are the typical seca advantages such as fold-up armrests and footrests, secure wheel brakes, an ergonomically shaped seat and smooth rollers, which, together with the ergonomically shaped handle, make it very easy to push the chair scale. Of course the seca 952 is also equipped with the important TARE function which allows every newly added weight to be ascertained separately and the Auto-HOLD function which lets medical personnel take care of the patient first and read out the results later.

- Capacity: 440 lbs / 200 kg
- Graduation: 0.2 lbs / 100 g
- Functions: TARE, Auto-HOLD, lbs/kg switch-over automatic switch-off



seca 954

seca 952

The large footrests can be folded completely out of the way so that the patient can safely and comfortably take a seat.

The footrests can be folded away to make it easier for patients to stand up and sit down.

## Every gram counts

when lying in bed.

Our bed and dialysis scales have been carefully tested in the past by specialists and intensive care consultants in dialysis and burn units. They are now also being used to an increasing extent in nursing homes, since every gram is important in the case of immobile patients, precision is what counts. The bed and dialysis scales from seca with their alarm function can assist critical monitoring in the case of clinical procedures involving the loss of fluid or special fluid turnover, or simply in areas where patients can be weighed only in bed.



## seca 984

Electronic bed and dialysis scale  
with equipment trolley

Always in use: the seca 984 facilitates the easy, gentle and precise weighing of bedridden patients and is an indispensable aid in dialysis and intensive care. With the integrated lifts, four load cells can be placed easily and effortlessly under the castors of the bed. The previously determined weight of the bed is deducted using the TARE function and the patient's precise weight is determined. In the event of a power failure, the scale stores all previously displayed values using rechargeable batteries. When not in use, the four bed lifts can be stored on the equipment trolley.

- Capacity: 1,100 lbs / 500 kg
- Graduation: 0.2 lbs < 440 lbs > 0.5 lbs / 100 g < 200 kg > 200 g
- Functions: TARE, Pre-TARE, HOLD, BMI, limit value, lbs/kg switch-over, damping
- Optional: RS232 interface seca 460



The patented lift mechanism permits placement of the load cells without any effort.

## Specialized scales

for unique medical needs.

As a specialist for medical measuring and weighing, seca naturally offers solutions for special medical applications. For instance, the splash-protected organ and diaper scale and precise portion and diet scale for clinical nutritionists offer an array of benefits to suit unique medical requirements.



The stainless steel surface is tough and easy-to-clean.



## seca 856

Digital organ and diaper scale with stainless steel cover

The organ scale seca 856 has been designed to meet the specific requirements in its area of application. The raised display is protected from soiling by fluids and the specially sealed battery compartment keeps moisture away from the electronic parts. This scale also fulfills tough hygienic standards with a sealed stainless steel surface that's easy to clean. With the aid of the Pre-TARE function, the additional weight of containers can simply be deducted for precise determination of net weight. The fine one-gram graduation ensures highly precise results.

- Capacity: 11 lbs / 5 kg
- Graduation: 0.05 oz < 6.6 lbs > 0.1 oz / 1 g < 3 kg > 2 g
- Functions: TARE, Pre-TARE, HOLD, lbs/kg switch-over, automatic switch-off



The smooth food-safe surface allows easy cleaning of the bowl.

## seca 852

Digital portion and diet scale

Operation of these scales with the TARE function is wonderfully simple. It can be repeatedly reset to zero, regardless of how many ingredients are already in the bowl. The scales and bowl are so perfectly matched that the scales simply slip into the bowl for storage.

- Capacity: 6.6 lbs / 3 kg
- Graduation: 0.05 oz / 1 g
- Functions: TARE, lbs/kg switch-over, automatic switch-off



Perfect fitting bowl for safe storage.

The fine graduation to just one gram permits precise weighing.





## seca printers don't just print – they also assist with analysis.

Measurements received from the seca 360° wireless products can be printed out by digital printer with wireless reception. The printers also assist with the analysis and interpretation of the data by presenting BMI in graphic displays and comparing growth percentiles of children with the relevant statistical norms.

### seca 466

seca 360° wireless digital printer with wireless reception and analysis of measurements on thermal paper or labels

With the seca 466 digital printer, measurements transmitted by the seca 360° wireless products can be printed quickly onto thermal paper or labels. It also handles the automatic interpretation and analysis of results. The printer formats a graph of weight, height and BMI and compares the findings to standard ranges. The required reference values and the hospital or doctor's practice logo can be configured easily with the seca print designer software.

- Print speed: 80 mm/sec
- Functions: print-out of height, weight, BMI, resting or total energy expenditure or percentiles for children, integrated automatic cutter
- Optional: 5 or 50 rolls of thermal paper seca 485, 1 or 24 rolls of labels seca 486
- Included with printer: SD smart card, power adapter, SD card reader, 1 roll of thermal paper, 1 roll of labels

**System compatible** with products of the seca 360° wireless system and connects wirelessly to a Welch Allyn Connex® Vital Signs Monitor, Welch Allyn Connex® Spot Monitor or Integrated Wall System.

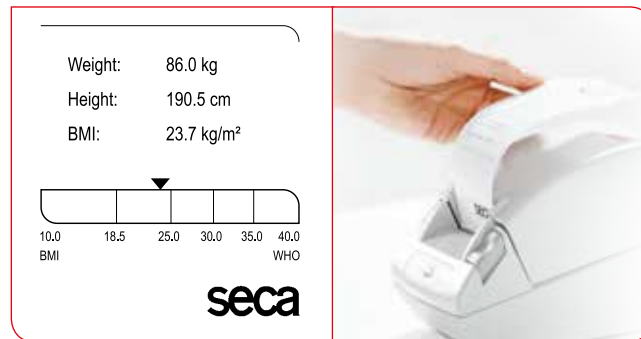

Height, weight, BMI, resting energy expenditure, total energy expenditure or percentiles for children – in the layout file you can choose the information you want.

### seca 465

seca 360° wireless digital printer with wireless reception and analysis of measurements on thermal paper

The seca 465 wireless printer is exactly the right partner for measuring rods and scales with wireless transmission by seca. Via its wireless receiver and pre-configured SD smart card, the printer receives the measurements transmitted by seca devices and analyzes the data. The printer compares height and weight to reference values as defined by WHO, CDC and Kromeyer-Hauschild et al., and ascertains percentiles for children. Resting energy expenditure and total energy expenditure based on parameters of gender, age and PAL (Physical Activity Level) are also calculated. As needed, Body-Mass-Index (BMI) or Body Fat Rate (BFR) can be analyzed and printed.

- Print speed: 80 mm/sec
- Functions: print-out of height, weight, BMI, resting or total energy expenditure or percentiles for children
- Optional: 5 or 50 rolls of thermal paper seca 485
- Included with printer: SD smart card, power adapter, SD card reader, 1 roll of thermal paper

**System compatible** with products of the seca 360° wireless system and connects wirelessly to a Welch Allyn Connex® Vital Signs Monitor, Welch Allyn Connex® Spot Monitor or Integrated Wall System.



The seca print designer software lets you integrate the logo used by the hospital/practice in the print-out. Or you can specify in which language the information should be printed.

## Software

The only solution that gives you more out of every measurement.

With the free software application seca emr flash 101, seca 360° wireless products can transmit their results wirelessly to any EMR system. The software is 100% compatible with all the EMR systems currently on the market. The software seca analytics 115 goes a step further by analyzing and interpreting the data from weight and height, within the program's 3 modules. Not only does this process support the doctor with early detection of disease, but also provides an immediate printout for the patient to review while they wait in the exam room, assisting in initiating weight discussion.

## seca analytics 115

Medical PC software for diagnostic assistance

With the network-capable software seca analytics 115, optionally available with three or six workstation licenses, the doctor can process the measurements from his seca devices in three modules on the PC and thereby significantly improve the quality of the medical examination. Assistance is provided by the three integrated modules "Energy", "Cardiometabolic Risk" and "Growth/Development". All the doctor has to do is select a seca 360° wireless product and push a key to generate an analysis and interpretation of the measurements taken. Medical inquiries about the patient's general health status and nutritional condition are answered in the modules, measurements compared to standard values and findings displayed in a therapy planner. The entire analysis can be printed on a conventional printer specially configured by the user. This type of diagnostic assistance adds a completely new dimension to medical advice and gives doctors' offices and hospitals a distinct competitive advantage.

### System requirements:

- Supported operating systems: Windows® 10, Windows® 8.1, Windows® 8, Windows® Server 2012 R2, Windows® Server 2012, Windows® 7 (SP1), Windows® Vista (SP1, SP2), Windows® Server 2008 R2 and Windows® Server 2008
- Processor: 1.2 GHz or higher
- Hard Disk Space: minimum 1 GB
- Memory: minimum 512 MB RAM
- Additional HW: DVD drive
- Ports: for usage in combination with seca medical devices USB port (2.0) or serial interface (RS232)
- Display: 1024x768, High Colour (16-bit), 32-bit (recommended)

- **System compatible** with products of the seca 360° wireless system and connects wirelessly to a Welch Allyn Connex® Vital Signs Monitor, Welch Allyn Connex® Spot Monitor or Integrated Wall System.

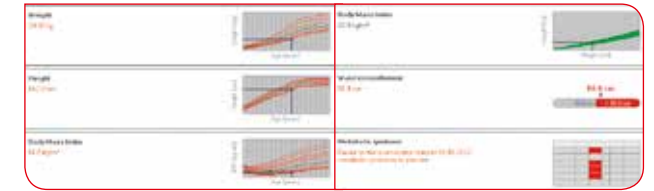

For an exact assessment of health status and nutritional condition of children, height, weight and BMI are compared to percentiles.

BMI, waist circumference and other laboratory data are used to assess the risk of coronary heart disease.

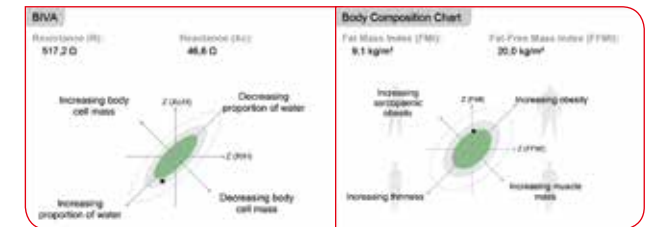

The proportion of fluid in the total body weight is important for prevention, diagnosis and therapy, e.g. for heart failure or kidney disease.

The composition and assessment of the body mass are important for the diagnosis and treatment of weight-related illnesses.



All examination results for each patient can be compiled into a PDF of one or more pages. The findings can be ideally prepared for a personal consultation.

## seca | service

### For seca analytics 115:

- Remote or on-site installation service
- Remote or on-site EMR integration service
- Remote or on-site software support



**Wireless data transmission**

## seca emr flash 101

Software to connect seca 360° wireless products to Electronic Medical Record (EMR) systems

Simple and efficient – medical science can take a giant step forward. The intuitive software seca emr flash 101, which transmits measurements directly to an EMR system, is now available as a download at [www.seca.com](http://www.seca.com). In just seconds your measurement data from seca 360° wireless measuring devices and scales is assigned to the right patient ID.

**System requirements:**

- Supported operating systems: Windows® 10, Windows® 8.1, Windows® 8, Windows® 7 (SP1) and Windows® Vista (SP1, SP2)
- Ports: for usage in combination with seca medical devices USB port (2.0) or serial interface (RS232)

**System compatible** with products of the seca 360° wireless system and connects wirelessly to a Welch Allyn Connex® Vital Signs Monitor, Welch Allyn Connex® Spot Monitor or Integrated Wall System.



### seca | service

**For seca analytics 101:**

- Remote or on-site installation service
- Remote or on-site EMR integration service
- Remote or on-site software support

**seca added value**

Is there a software program that can communicate with all EMR systems? Of course – from seca. No other manufacturer of measuring systems and scales offers direct wireless data transmission to an EMR system. But with the software application seca emr flash 101, you can transmit your measurements from seca 360° wireless products directly into an EMR system. The technological standard of the EMR system doesn't matter at all.

### Accessories

## seca 456

seca 360° USB adapter for wireless data reception



The USB adapter seca 456 enables any PC to receive wireless data from seca measuring systems and scales. This eliminates annoying cable connections in the examination rooms and, with the PC software seca analytics 115, allows measurements to be stored in the seca database or fed into an EMR system, and provides other parameters in a PDF file (EMR-integrated). The labor-intensive process of documenting examination findings is turned into a speedy and paperless matter.

**System requirements:**

- Supported operating systems: Windows® 10, Windows® 8.1, Windows® 8, Windows® Server 2012 R2, Windows® Server 2012, Windows® 7 (SP1), Windows® Vista (SP1, SP2), Windows® Server 2008 R2 and Windows® Server 2008
- Version: seca 456 wa for wireless data transmission to the Welch Allyn Connex® Vital Signs Monitor (CVSM), Welch Allyn Connex® Spot Monitor or Integrated Wall System

**System compatible** with products of the seca 360° wireless system and connects wirelessly to a Welch Allyn Connex® Vital Signs Monitor, Welch Allyn Connex® Spot Monitor or Integrated Wall System.



*The wireless reception of measurements on the PC is the decisive step toward Electronic Medical Records.*



## seca mBCA



**seca mBCA 514**

CE 0123

Medical Body Composition Analyzer for determining body composition while standing.

Page 10

Page 08-17

General	
Dimensions (WxHxD)	38.4 x 49.3 x 32.6" 976 x 1,251 x 828 mm
Capacity	660 lbs / 300 kg
Graduation	0.1 lbs < 330 lbs > 0.2 lbs 50 g < 150 kg > 100 g
Weight	79.4 lbs / 36 kg
Display	8.4" Touch-screen display, can be rotated 360°
Power supply	power adapter
Interfaces	Touch-screen display USB 2.0 weighing platform Ethernet (10/100 Base-T)
Compatible printers	laser printer and inkjet printer via PC software seca analytics 115
Bioelectrical Impedance Analysis	
Measurement method	8-point Bioelectrical Impedance Analysis
Measurement frequencies	1; 1.5; 2; 3; 5; 7.5; 10; 15; 20; 30; 50; 75; 100; 150; 200; 300; 500; 750; 1,000 kHz
Measurement segments	right arm, left arm, right leg, left leg, right half of body, left half of body, torso
Measurement current	100 µA
Measurement time	17 seconds
Technical data for scale	
Capacity	Weighing range 1 = 330 lbs / 150 kg Weighing range 2 = 660 lbs / 300 kg
Fine graduation	Weighing range 1 = 110 lbs / 50 g Weighing range 2 = 220 lbs / 100 g
Accessories	
PC software seca analytics 115 (with one workstation license included) combined with seca 360° wireless measuring systems	



**seca mBCA 525**

CE 0123

Medical Body Composition Analyzer for determining body composition while lying down.

Page 12

Dimensions (WxHxD)	9.9 x 10.3 x 9.1" 252 x 262 x 230 mm
Weight	6.6 lbs / 3 kg
Display	7" Touch-screen display
Power supply	power adapter, rechargeable battery
Interfaces	Wi-Fi, Ethernet, USB 2.0, seca 360° wireless technology
Compatible printers	laser printer and inkjet printer via PC software seca analytics 115
Measurement method	8-point Bioelectrical Impedance Analysis
Measurement frequencies	1; 2; 5; 10; 50; 100; 200; 500 kHz
Measurement segments	right arm, left arm, right leg, left leg, right half of body, left half of body, torso
Measurement current	100 µA
Measurement time	30 seconds
Capacity	Weighing range 1 = 110 lbs / 50 g Weighing range 2 = 220 lbs / 100 g
Accessories	PC software seca analytics 115 (with one workstation license included) combined with seca 360° wireless measuring systems and scales

## Accessories for seca mBCA



**seca 475**

Rolling stand with basket for the mobile use of the seca mBCA 525.

Page 13



**seca 432**

Carrying case for seca mBCA 525.

Page 13

Technical data	
Dimensions (WxHxD)	23.6 x 23.6" (WxD) 600 x 600 mm, Height adjustable from 27.4-46.6" 695-1,185 mm
Weight	23.2 lbs / 10.5 kg

Dimensions (WxHxD)	16.1 x 12.2 x 11.6" 410 x 310 x 295 mm
Weight	2.1 lbs / 950 g

## Software



**seca analytics 115**

Medical PC software for diagnostic assistance.

Page 16

### Technical data

Dimensions (WxHxD)

5.4 x 7.6 x 0.3"  
137 x 192 x 7 mm

### System requirements

Supported operating systems

Windows® 10,  
Windows® 8.1,  
Windows® 8, Windows®  
Server 2012 R2,  
Windows® Server 2012,  
Windows® 7 (SP1),  
Windows® Vista  
(SP1, SP2), Windows®  
Server 2008 R2 and  
Windows® Server 2008

Processor

1.2 GHz or higher

Hard Disk Space

minimum 1 GB

Memory

minimum 512 MB RAM

Additional HW

DVD drive

Ports

for usage in combination  
with seca medical devices  
USB port (2.0) or serial  
interface (RS232)

Display

1,024 x 768,  
High Color (16-bit),  
32-bit (recommended)

### System compatible with

seca 360° wireless

all measuring devices  
and scales in the  
seca 360° wireless system

## Accessories for software



**seca 456**

seca 360° wireless USB  
adapter for data reception  
on PC.

Page 23

### Technical data

Dimensions (WxHxD)

3.3 x 0.9 x 0.4"  
85 x 23 x 10 mm

Weight

0.026 lbs / 12 g

### System requirements

Supported operating systems

Windows® 10,  
Windows® 8.1,  
Windows® 8, Windows®  
Server 2012 R2,  
Windows® Server 2012,  
Windows® 7 (SP1),  
Windows® Vista  
(SP1, SP2), Windows®  
Server 2008 R2 and  
Windows® Server 2008

Ports

for usage in combination  
with seca medical devices  
USB port (2.0)







### System compatible with

seca 360° wireless

all measuring devices  
and scales in the  
seca 360° wireless system



## Baby scales







	 <b>seca 727</b>	 <b>seca 374</b>	 <b>seca 334</b>	 <b>seca 354</b>	 <b>seca 725</b>
	Digital baby scale with fine 1 g graduation with wireless transmission.	Digital baby scale with wireless transmission.	Digital baby scale with practical handle for mobile medical use.	Multi-purpose, digital baby scale also converts to flat scale for children.	Mechanical baby scale with sliding weights.
Page 28–37	Page 30	Page 32	Page 34	Page 36	Page 37
<b>Technical data</b>					
Capacity	44 lbs / 20 kg	44 lbs / 20 kg	44 lbs / 20 kg	44 lbs / 20 kg	16 kg
Graduation	0.1 oz 1 g < 6 kg > 2 g	0.2 oz < 22 lbs > 0.5 oz 5 g < 10 kg > 10 g	0.2 oz < 22 lbs > 0.5 oz 5 g < 10 kg > 10 g	0.5 oz < 22 lbs > 1 oz 10 g < 10 kg > 20 g	5 g
Dimensions (WxHxD)	21.7 x 5.9 x 12.6" 551 x 151 x 320 mm	24.4 x 7.5 x 14.1" 620 x 190 x 358 mm	25.1 x 4.1 x 11.8" 638 x 105 x 300 mm	21.7 x 6.1 x 13.1" 552 x 156 x 332 mm	21.7 x 7.1 x 11.4" 550 x 180 x 290 mm
Dimensions/tray (WxHxD)	21.3 x 4.3 x 9.8" 540 x 110 x 250 mm	24.2 x 5.1 x 10.8" 615 x 130 x 275 mm	23.4 x 2 x 10" 595 x 50 x 255 mm	20.7 x 3.1 x 9.8" 525 x 80 x 250 mm	21.7 x 4.3 x 10.6" 550 x 110 x 270 mm
Dimensions/platform (WxHxD)				11 x 2.6 x 9.3" 280 x 65 x 235 mm	
Weight	15.7 lbs / 7.1 kg	7.9 lbs / 3.6 kg	6.2 lbs / 2.8 kg	5 lbs / 2.3 kg	14.1 lbs / 6.4 kg
Power supply	Power adapter, rechargeable batteries	Batteries, power adapter optional	Batteries, power adapter optional	Batteries	
<b>Functions</b>					
TARE	•	•	•	•	
BMIF		•	•	•	
HOLD	•				
Auto-HOLD	•	•	•	•	
Automatic weighing range switch-over	•				
lbs/kg switch-over	•	•	•	•	
Damping	•	•			
Reset-to-zero function					•
Acoustic signals can be activated	•	•			
RESET	•	•			
Automatic switch-off	•	•	•	•	
SEND/Auto-SEND	•	•			
PRINT/Auto-PRINT	•	•			
Measuring rod included	•				
<b>Optional</b>					
Mobile carts	seca 403, seca 402	seca 403, seca 402	seca 403, seca 402	seca 403, seca 402	
Measuring rod/measuring board		seca 233	seca 232	seca 417	
Head/foot positioner		seca 418	seca 419		
Power adapter		seca 400	seca 400		
Interface cable					
Carrying case			seca 428	seca 409, seca 414, seca 431, seca 413	
<b>Areas of application</b>					
Mobile weighing	•		•	•	
<b>System compatible with</b>					
products of the seca 360° wireless system	•	•			
EMR	•	•			



## Accessories for baby scales









							
	<b>seca 403</b>	<b>seca 402</b>	<b>seca 233</b>	<b>seca 232</b>	<b>seca 418</b>	<b>seca 419</b>	<b>seca 400</b>
	Cart for mobile support with customized indentations for seca baby scales seca 727, seca 728, seca 374, seca 334, and seca 354.	Cart for mobile support with customized indentations for seca baby scales seca 727, seca 728, seca 374, seca 334, and seca 354.	Measuring rod for baby scale seca 374.	Measuring rod for baby scale, accessory for seca 334.	Head and foot positioners for baby scale seca 374 when the measuring rod seca 233 is not installed.	Head positioners for baby scale seca 334.	Switch-mode power adapter for baby scales seca 374 and seca 334.
	<b>Page 31</b>	<b>Page 31</b>	<b>Page 33</b>	<b>Page 35</b>	<b>Page 33</b>	<b>Page 34</b>	<b>Page 32</b>
<b>Technical data</b>							
Maximum load	220 lbs / 100 kg	220 lbs / 100 kg					
Measuring range			14–32" / 35–80 cm	14–32" / 35–80 cm			
Graduation			1/8" / 1 mm	1/8" / 1 mm			
Dimensions (WxHxD)	28.2 x 31.5 x 17.1" 715 x 800 x 435 mm	28.2 x 31.5 x 17.1" 715 x 800 x 435 mm	25.2 x 7 x 11.7" 641 x 179 x 296 mm	25.2 x 5.7 x 10.9" 640 x 145 x 277 mm	8.1 x 5.8 x 2.7" 205 x 148 x 69 mm	8.1 x 5.7 x 1.8" 205 x 145 x 45 mm	1.7 x 1.4 x 2.9" 42 x 35 x 73 mm
Cable length							72.8" / 1.85 m
Weight	60.6 lbs / 27.5 kg	25.4 lbs / 11.5 kg	1.5 lbs / 700 g	1.1 lbs / 512 g	0.9 lbs / 400 g	0.3 lbs / 142 g	0.3 lbs / 155 g
<b>Optional</b>							
Paper roll holder		seca 408					

## Accessories for baby scales

					
	<b>seca 428</b>	<b>seca 409</b>	<b>seca 414</b>	<b>seca 431</b>	<b>seca 413</b>
	Stable and roomy carrying case for the seca 334 baby scale.	Backpack to transport baby scale seca 354 together with the measuring board seca 417 or the measuring mat seca 210.	Case with handle and shoulder strap for electronic baby scale seca 354 in combination with seca 417 or seca 210.	Backpack to transport baby scales safely and comfortably.	Carrying case for baby scale seca 354.
	<b>Page 35</b>	<b>Page 36</b>	<b>Page 36</b>	<b>Page 36</b>	<b>Page 37</b>
<b>Technical data</b>					
Measuring range					
Graduation					
Dimensions (WxHxD)	24.8 x 13 x 4.3" 630 x 330 x 110 mm	14.6 x 24.8 x 5.5" 370 x 630 x 140 mm	24.6 x 13.8 x 8.3" 625 x 350 x 210 mm	15 x 22.8 x 6.7" 380 x 580 x 170 mm	22.4 x 5.9 x 13" 570 x 150 x 330 mm
Cable length					
Weight	2.6 lbs / 1.2 kg	3.5 lbs / 1.6 kg	6.2 lbs / 2.8 kg	1.8 lbs / 800 g	1.9 lbs / 900 g



## Pediatric measuring systems









	 <b>seca 416</b>	 <b>seca 417</b>	 <b>seca 210</b>	 <b>seca 207</b>	 <b>seca 212</b>	 <b>seca 218</b>	 <b>seca 211</b>
	Infantometer with raised sides and footpiece mounted on two rails.	Light, space saving measuring board ideal for mobile use.	Measuring mat for babies and infants.	Measuring rod with extra-wide measuring slides. Wall mounting possible.	Head circumference measuring tape for babies and infants, made of non-stretch material. For measuring head circumference and symmetry.	Disposable measuring tape in practical wall dispenser.	Disposable measuring tape for head circumference in practical wall dispenser.
<b>Page 38–47</b>	<b>Page 38</b>	<b>Page 40</b>	<b>Page 42</b>	<b>Page 44</b>	<b>Page 44</b>	<b>Page 45</b>	<b>Page 46</b>
<b>Technical data</b>							
Measuring range	13–39" / 33–100 cm	4–39" / 10–100 cm	4–39" / 10–99 cm	0–39" / 0–99 cm	1–23" / 3–59 cm	0–36" / 0–100 cm	12–59 cm / 5–23"
Graduation	1/16" / 1 mm	1/16" / 1 mm	1/4" / 5 mm	1/8" / 1 mm	1/16" / 1 mm	1/8" / 1 mm	1 mm / 1/16"
Dimensions (WxHxD)	43.4 x 6.7 x 15.8" 1,103 x 169 x 402 mm	43.7 x 4.5 x 13.1" 1,110 x 115 x 333 mm	49.2 x 5.5 x 11.8" 1,250 x 140 x 300 mm	41.2 x 4.7 x 11.3" 1,047 x 120 x 286 mm	1 x 0.01 x 26.1" 25 x 0.2 x 663 mm 5.5 x 5.7 x 1.2" 140 x 145 x 30 mm	20 x 0.2 x 1,200 mm 0.8 x 0.01 x 47.2" 1.97 x 2.87 x 1.42" 50 x 73 x 36 mm	1 x 0.01 x 27.6" 25 x 0.2 x 701.5 mm 1.97 x 2.87 x 1.42" 50 x 73 x 36 mm
Dimensions box (WxHxD)							
Dimensions when folded (WxHxD)		22.7 x 4.5 x 13.1" 577 x 115 x 333 mm	4.7 x 5.5 x 11.8" 120 x 140 x 300 mm	41.2 x 4.7 x 1.2" 1,047 x 120 x 30 mm			
Weight	8.4 lbs / 3.8 kg	3.5 lbs / 1.6 kg	1.3 lbs / 575 g	1.8 lbs / 810 g	0.1 lbs / 60 g (box) 15 pieces	4 g / 0.14 oz 500 (inkl. dispenser) / 1,000 pieces	1.6 g / 0.06 oz 500 (inkl. dispenser) / 1,000 pieces
Quantity in dispenser							
<b>Optional</b>							
Carrying case/bag		seca 409, seca 414, seca 412	seca 409, seca 414				
<b>Areas of application</b>							
Can be mounted							
Mobile measuring		•	•	•	•		•

## Accessories for pediatric measuring systems

	 <b>seca 409</b>	 <b>seca 414</b>	 <b>seca 412</b>	 <b>seca 102</b>	 <b>seca 405 (b/g)</b> <b>seca 406 (b/g)</b>	 <b>seca 407 (b/g)</b>
	Backpack to transport baby scale seca 354 together with the measuring board seca 417 or the measuring mat seca 210.	Case for the measuring instruments seca 417 together with baby scale seca 354.	Case for infantometer seca 417.	Convenient pads for recording a child's vital growth information.	Growth charts for boys (blue) and girls (pink) for tracking length/height, weight, head circumference and Body-Mass-Index percentiles by age.	Recommended for breast fed infants based on WHO (World Health Organization) standards. Covers up to 24 months.
<b>Page 40</b>	<b>Page 40</b>	<b>Page 41</b>	<b>Page 47</b>	<b>Page 47</b>	<b>Page 47</b>	
<b>Technical data</b>						
Dimensions (WxHxD)	14.6 x 24.8 x 5.5" 370 x 630 x 140 mm	24.6 x 13.8 x 8.3" 625 x 350 x 210 mm	27 x 16.8 x 2.2" 686 x 427 x 56 mm	4 1/4 x 5 1/2"	8 1/2 x 11"	8 1/2 x 11"
Weight	3.5 lbs / 1.6 kg	6.2 lbs / 2.8 kg	1.4 lbs / 650 g			
Quantity				Five 100-page pads per pack	100 sheets per pad	100 sheets per pad











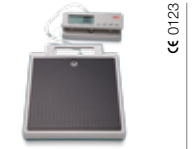

## Measuring stations and column scales

	 CE 0123	 CE 0123	 CE 0123	 CE 0123	 CE 0123	 CE 0123	 CE 0123	 CE 0123
	<b>seca 286 dp</b>	<b>seca 284 dp</b>	<b>seca 763</b>	<b>seca 703</b>	<b>seca 703 s</b>	<b>seca 769</b>	<b>seca 700</b>	<b>seca 755</b>
	Wireless ultrasonic measuring station for height and weight with voice guidance.	Digital measuring station with wireless transmission of height and weight.	High-capacity digital measuring station consisting of scale, measuring rod and BMI calculator.	High capacity column scale with wireless transmission.	Wireless column scale with integrated measuring rod.	Digital column scale with BMI function, low-maintenance, easy to transport.	Mechanical column scale with eye-level beam.	Mechanical column scale with large dial and automatic display of the BMI range in kg or lbs version.
	Page 48–63	Page 50	Page 52	Page 54	Page 56	Page 58	Page 59	Page 60
<b>Technical data</b>								
Capacity	660 lbs / 300 kg	660 lbs / 300 kg	550 lbs / 250 kg	660 lbs / 300 kg	660 lbs / 300 kg	450 lbs / 200 kg	500 lbs, 220 kg or 400 lbs / 160 kg	350 lbs / 160 kg, 160 kg
Graduation	0.1 lbs / 50 g	0.1 lbs / 50 g	0.1 lbs / 50 g	0.1 lbs < 330 lbs > 0.2 lbs 50 g < 150 kg > 100 g 0.1 lbs < 23 sts > 0.2 lbs	0.1 lbs < 330 lbs > 0.2 lbs 50 g < 150 kg > 100 g 0.1 lbs < 23 sts > 0.2 lbs	0.2 lbs / 100 g	1/8 lbs, 50 g or 1/4 lbs / 100 g	1 lbs / 500 g, 500 g
Measuring range measuring rod	1 ft 11 5/8" – 6 ft 10 5/8" 60–210 cm	11" – 7 ft 2" 30–220 cm	43–79" / 110–200 cm		3–90" / 6–230 cm			
Graduation measuring rod	1/8" / 1 mm	1/8" / 1 mm	1/8" / 1 mm		1/8" / 1 mm			
Dimensions (WxHxD)	17.1 x 89.4 x 18.3" 434 x 2,270 x 466 mm	17.1 x 94.3 x 18.3" 434 x 2,394 x 466 mm	14.2 x 84.6 x 27.2" 360 x 2,150 x 690 mm	14.2 x 36.6 x 20.5" 360 x 930 x 520 mm	14.2 x 94.1 x 20.5" 360 x 2,390 x 520 mm	11.6 x 32.7 x 16.4" 294 x 831 x 417 mm	20.5 x 61.3 x 20.5" 520 x 1,556 x 520 mm	14.2 x 39.4 x 24.7" 360 x 1,000 x 628 mm
Dimensions/platform (WxHxD)	16.9 x 2.4 x 14.4" 430 x 60 x 365 mm	16.9 x 2.4 x 14.4" 430 x 60 x 365 mm	13.2 x 3.1 x 13.6" 335 x 80 x 345 mm	13.2 x 3.1 x 13.6" 335 x 80 x 345 mm	13.2 x 3.1 x 13.6" 335 x 80 x 345 mm	10.7 x 3 x 11" 272 x 75 x 280 mm	13.2 x 3.1 x 13.6" 335 x 80 x 345 mm	13.2 x 3.1 x 13.6" 335 x 80 x 345 mm
Weight	36.5 lbs / 16.5 kg	35.3 lbs / 16 kg	36.8 lbs / 16.7 kg	35 lbs / 15.9 kg	38.8 lbs / 17.6 kg	13.7 lbs / 6.2 kg	35.7 lbs / 16.2 kg	39.9 lbs / 18.1 kg
Power supply	Power adapter	Batteries, power adapter	Power adapter	Batteries, power adapter optional	Batteries, power adapter optional	Batteries, power adapter optional		
<b>Functions/Accessories</b>								
TARE	•	•	•	•	•	•	•	•
Pre-TARE	•	•	•	•	•	•	•	•
Mother/child function	•	•	•	•	•	•	•	•
HOLD	•	•	•	•	•	•	•	•
Auto-HOLD	•	•	•	•	•	•	•	•
BMI	•	•	•	•	•	•	•	•
Auto-BMI	•	•	•	•	•	•	•	•
BFR	•	•	•	•	•	•	•	•
Patient data input	•	•	•	•	•	•	•	•
CLEAR	•	•	•	•	•	•	•	•
Auto-CLEAR	•	•	•	•	•	•	•	•
lbs/kg switch-over	•	•	•	•	•	•	•	•
inch/cm switch-over	•	•	•	•	•	•	•	•
Damping	•	•	•	•	•	•	•	•
User-defined zero setting	•	•	•	•	•	•	•	•
Reset-to-zero function	•	•	•	•	•	•	•	•
Backlighting	•	•	•	•	•	•	•	•
Acoustic signals can be activated	•	•	•	•	•	•	•	•
RESET	•	•	•	•	•	•	•	•
Calibration/automatic calibration	•	•	•	•	•	•	•	•
Automatic switch-off	•	•	•	•	•	•	•	•
SEND/Auto-SEND	•	•	•	•	•	•	•	•
PRINT/Auto-PRINT	•	•	•	•	•	•	•	•
Integrated measuring rod	•	•	•	seca 220	seca 220	seca 220	seca 220	•
Transport castors	•	•	•	•	•	•	•	•
<b>Optional</b>								
Printer holder	seca 481 (for seca 465), seca 482 (for seca 466)	seca 481 (for seca 465), seca 482 (for seca 466)						
Measuring rod				seca 224		seca 224		seca 224
RS232 interface			seca 460					
Power adapter				seca 400	seca 400	seca 400		
<b>System compatible with</b>								
products of the seca 360° wireless system	•	•		•	•			
EMR	•	•		•	•			





**Flat scales**

									
	<b>seca 634</b>	<b>seca 869</b>	<b>seca 874</b>	<b>seca 876</b>	<b>seca 874 dr</b>	<b>seca 813</b>	<b>seca 803</b>	<b>seca 762</b>	<b>seca 750</b>
	Digital platform and bariatric scale with wireless transmission.	Robust flat scale with cable remote display, BMI, HOLD and TARE for mobile use.	Digital flat scale for mobile use with push buttons and double display.	Digital flat scale with integrated display.	Doctor's scale with customizable label.	High capacity digital flat scale for individual patient use.	Digital flat scale for individual patient use.	Mechanical flat scale with large dial and fine 1 lbs graduation.	Mechanical flat scale with robust, powder-coated steel casing. lbs/kg, kg and lbs version available.
<b>Page 64–73</b>	<b>Page 66</b>	<b>Page 67</b>	<b>Page 68</b>	<b>Page 70</b>	<b>Page 71</b>	<b>Page 72</b>	<b>Page 72</b>	<b>Page 73</b>	<b>Page 73</b>
<b>Technical data</b>									
Capacity	800 lbs / 360 kg	550 lbs / 250 kg	440 lbs / 200 kg	550 lbs / 250 kg	440 lbs / 200 kg	440 lbs / 200 kg	330 lbs / 150 kg	320 lbs, 150 kg, 320 lbs / 150 kg	320 lbs, 150 kg, 320 lbs / 150 kg
Graduation	0.1 lbs / 50 g	0.2 lbs < 330 lbs > 0.5 lbs 100 g < 150 kg > 200 g	0.1 lbs < 330 lbs > 0.2 lbs 50 g < 150 kg > 100 g	0.2 lbs < 330 lbs > 0.5 lbs 100 g < 150 kg > 200 g	0.1 lbs < 330 lbs > 0.2 lbs 50 g < 150 kg > 100 g	0.2 lbs / 100 g	0.2 lbs / 100 g	1 lbs, 500 g, 1 lbs / 500 g	1 lbs, 1 kg, 1 lbs / 1 kg
Dimensions (WxHxD)	25.2 x 2.1 x 23.6" 640 x 53 x 600 mm	12.6 x 2.4 x 14" 321 x 60 x 356 mm	12.6 x 2.4 x 14.2" 321 x 60 x 361 mm	12.6 x 2.4 x 14" 321 x 60 x 356 mm	12.6 x 2.4 x 14.2" 321 x 61 x 361 mm	17 x 1.9 x 14.7" 433 x 47 x 373 mm	12.4 x 1.5 x 12.8" 316 x 37 x 326 mm	12 x 4.7 x 18.5" 305 x 120 x 470 mm	12.5 x 4.6 x 18.8" 317 x 117 x 477 mm
Dimensions/platform (WxHxD)	22 x 2.2 x 22" 560 x 55 x 560 mm	11 x 2.4 x 10.9" 280 x 60 x 278 mm	11.3 x 2.4 x 11" 288 x 60 x 280 mm	11.3 x 2.4 x 10.9" 288 x 60 x 278 mm	11.3 x 2.4 x 11" 288 x 60 x 280 mm	15.7 x 1.8 x 11.8" 400 x 45 x 300 mm	11.6 x 1.4 x 12" 295 x 35 x 305 mm	10.2 x 2.8 x 10.4" 260 x 70 x 265 mm	11.4 x 2.8 x 11.4" 290 x 70 x 290 mm
Cable length	98.4" / 2.5 m	78.7" / 2 m							
Weight	31.7 lbs / 14.4 kg	9.9 lbs / 4.5 kg	9 lbs / 4.1 kg	9.3 lbs / 4.2 kg	9 lbs / 4.1 kg	6.4 lbs / 2.9 kg	3.3 lbs / 1.5 kg	7.7 lbs / 3.5 kg	7.7 lbs / 3.5 kg
Power supply	Batteries, power adapter optional	Batteries, power adapter optional	Batteries	Batteries	Batteries	Batteries	Batteries		
<b>Functions</b>									
TARE	•	•							
Pre-TARE	•								
Mother/child function			•	•	•				
HOLD	•	•							
Auto-HOLD	•		•	•	•	•	•		
Step-off						•	•		
BMI	•	•							
lbs/kg switch-over	•	•	•	•	•	•	•		
Auto-CLEAR	•								
Damping	•								
Reset-to-zero function								•	•
Tip-on automatic switch-on				•		•	•		
RESET	•								
Automatic switch-off	•	•	•	•	•	•	•		
SEND/Auto-SEND	•								
PRINT/Auto-PRINT	•								
Transport castors	•								
<b>Optional</b>									
Measuring rod		seca 217	seca 217	seca 217					
Stand for cable remote display	seca 472								
Adapter element		seca 437	seca 437	seca 437					
Power adapter	seca 400	seca 400			seca 400				
Carrying case		seca 409, seca 414, seca 421	seca 409, seca 414, seca 415	seca 409, seca 414, seca 415			seca 415		
Individualizable label					seca 478				
<b>Areas of application</b>									
Mobile weighing		•	•	•			•		
<b>System compatible with</b>									
products of the seca 360° wireless system	•								
EMR	•								













## Accessories for measuring stations, column and flat scales

											 <b>new</b>
	<b>seca 224</b>	<b>seca 220</b>	<b>seca 472</b>	<b>seca 437</b>	<b>seca 460</b>	<b>seca 400</b>	<b>seca 409</b>	<b>seca 414</b>	<b>seca 421</b>	<b>seca 415</b>	<b>seca 478</b>
	Telescopic measuring rod for seca column scales.	Telescopic measuring rod for seca column scales.	Stand for display elements of seca scales with cable remote displays.	Adapter element for the flat scales seca 869, seca 874 and seca 876 in combination with stadiometer seca 217.	RS232 interface for transmitting data to the serial interface of a PC or printer for seca 763.	Switch-mode power adapter for column and flat scales seca 703, seca 769, seca 634 and seca 869.	Backpack to transport the flat scales seca 869, seca 874, and seca 876 together with the stadiometer seca 217 and the adapter element seca 437.	Case for the flat scale seca 869, seca 874 or seca 876 together with stadiometer seca 217 and adapter element seca 437.	Stable and roomy carrying case for most flat scales.	Carrying case for the flat scales seca 874, seca 876 and seca 803.	Customizable label for doctor scale 874 dr.
	<b>Page 59</b>	<b>Page 61</b>	<b>Page 67</b>	<b>Page 69</b>	<b>Page 55</b>	<b>Page 57</b>	<b>Page 68</b>	<b>Page 67</b>	<b>Page 67</b>	<b>Page 71</b>	<b>Page 71</b>
<b>Technical data</b>											
Measuring range	24–78" / 60–200 cm	24–78" / 60–200 cm									
Graduation	1/8" / 1 mm	1/8" / 1 mm									
Dimensions (WxHxD)	2.2 x 58.3 x 11.3" 55 x 1,480 x 286 mm	2.2 x 58.3 x 11.3" 55 x 1,480 x 286 mm	18.1 x 40.7 x 18.1" 460 x 1,035 x 460 mm	13.1 x 3.4 x 12.2" 333 x 86 x 310 mm	3.9 x 1 x 2.4" 100 x 25 x 60 mm 11.8 + 47.2" / 0.3 m + 1.2 m	1.7 x 1.4 x 2.9" 42 x 35 x 73 mm 72.8" / 1.85 m	14.6 x 24.8 x 5.5" 370 x 630 x 140 mm	24.6 x 13.8 x 8.3" 625 x 350 x 210 mm	16.9 x 13.8 x 5.1" 430 x 350 x 130 mm	13 x 15 x 2.8" 330 x 380 x 70 mm	257 x 32 x 2 mm 10 x 1.3 x 0.1"
Cable length											
Weight	3.1 lbs / 1.4 kg	1.5 lbs / 700 g	17.2 lbs / 7.8 kg	1.3 lbs / 600 g	0.3 lbs / 122 g	0.3 lbs / 155 g	3.5 lbs / 1.6 kg	6.2 lbs / 2.8 kg	1.8 lbs / 810 g	800 g / 1.8 lbs	2 g / 0.07 lbs















## Height measuring systems

	 <b>seca 274</b> €€ 0123	 <b>seca 264</b> €€ 0123	 <b>seca 217</b> €€ 0123	 <b>seca 213</b> €€ 0123	 <b>seca 222</b> €€ 0123	 <b>seca 216</b> €€ 0123	 <b>seca 206</b> €€ 0123	 <b>seca 203</b> €€ 0123	 <b>seca 201</b> €€ 0123
	Digital mobile stadiometer with wireless transmission.	Digital stationary stadiometer with wireless transmission.	Stand-alone stadiometer for height measurement, with spacer, consisting of parts that fit together perfectly for ease of transport.	Stand-alone stadiometer for height measurement, easily assembled for convenient transport.	Telescopic measuring rod for the wall with extrawide measuring slides and heel stop.	Mechanical stadiometer. Head piece with locking screw for accuracy.	Roll-up measuring tape with wall attachment.	Ergonomic, smoothly extractable circumference measuring tape with WHR calculator to determine body fat distribution.	Ergonomic, smoothly extractable measuring tape for determining body circumference.
<b>Page 74–81</b>	<b>Page 76</b>	<b>Page 77</b>	<b>Page 78</b>	<b>Page 79</b>	<b>Page 79</b>	<b>Page 80</b>	<b>Page 80</b>	<b>Page 81</b>	<b>Page 81</b>
<b>Technical data</b>									
Measuring range	11"–7 ft 2" 30–220 cm	11"–7 ft 2" 30–220 cm	8"–81" / 20–205 cm	8"–81" / 20–205 cm	2–90" / 6–230 cm	max. 55.3" / 138 cm selectable from 1.4–90" / 3.5–230 cm	0–87" / 0–220 cm	0–80" / 0–205 cm	0–80" / 0–205 cm
Graduation	1/8" / 1 mm	1/8" / 1 mm	1/8" / 1 mm	1/8" / 1 mm	1/8" / 1 mm	1/16" / 1 mm	1/8", 1 mm	1/8", 1 mm	1/8", 1 mm
Dimensions (WxHxD)	17.1 x 94.3 x 18.3" 434 x 2,394 x 466 mm	16.9 x 91.3 x 18.7" 428 x 2,318 x 474 mm	12.9 x 84.4 x 22.6" 328 x 2,145 x 574 mm	13.3 x 83.9 x 23.2" 337 x 2,130 x 590 mm	12.1 x 91.3 x 11.3" 308 x 2,320 x 286 mm	4.7 x 59.1 x 8.5" 120 x 1,500 x 217 mm	4.9 x 4.9 x 6.8" 125 x 125 x 173 mm	2.8 x 1.1 x 2.6" 70 x 28 x 66 mm	2.8 x 0.9 x 2.6" 70 x 22 x 65 mm
Dimensions/platform (WxHxD)	16.9 x 2.4 x 14.4" 430 x 60 x 365 mm	16.9 x 0.1 x 14.6" 430 x 3 x 370 mm							
Dimensions when folded (WxHxD)				13.3 x 7 x 24.6" 337 x 177 x 624 mm	12.1 x 52 x 11.3" 308 x 1,320 x 286 mm				
Weight	33.1 lbs / 15 kg	11 lbs / 5 kg	7.9 lbs / 3.6 kg	5.3 lbs / 2.4 kg	2.4 lbs / 1.1 kg	3.7 lbs / 1.7 kg	0.4 lbs / 202 g	0.2 lbs / 70 g	0.1 lbs / 50 g
Power supply	Batteries	Batteries							
<b>Functions</b>									
HOLD	•	•							
WHR calculator								•	
inch/cm switch-over	•	•							
User-defined zero setting	•	•							
Backlighting	•	•							
Acoustic signals can be activated	•	•							
RESET	•	•							
Calibration/automatic calibration	•	•							
Automatic switch-off	•	•							
SEND/Auto-SEND	•	•							
PRINT/Auto-PRINT	•	•							
Transport castors	•								
<b>Optional</b>									
Adapter element			seca 437						
Carrying case			seca 409, seca 414, seca 412	seca 412					
<b>Areas of application</b>									
Can be mounted		•			•	•	•	•	•
Mobile measuring			•	•				•	•
<b>System compatible with</b>									
products of the seca 360° wireless system	•	•							
EMR	•	•							

## Accessories for height measuring systems

	 <b>seca 437</b>	 <b>seca 409</b>	 <b>seca 414</b>	 <b>seca 412</b>
	Adapter element for stadiometer seca 217 in combination with flat scales seca 869, seca 874 and seca 876..	Backpack to transport the flat scales seca 876, seca 874 and seca 869 together with the stadiometer seca 217 and the adapter element seca 437.	Case for stadiometer seca 217 together with flat scale seca 876, seca 874 or seca 869 and adapter element seca 437.	Case for mobile stadiometer seca 217 or seca 213.
<b>Page 78</b>	<b>Page 78</b>	<b>Page 78</b>	<b>Page 78</b>	<b>Page 78</b>
<b>Technical data</b>				
Dimensions (WxHxD)	13.1 x 3.4 x 12.2" 333 x 86 x 310 mm	370 x 630 x 140 mm	24.6 x 13.8 x 8.3" 625 x 350 x 210 mm	27 x 16.8 x 2.2" 686 x 427 x 56 mm
Weight	1.3 lbs / 600 g	3.5 lbs / 1.6 kg	6.2 lbs / 2.8 kg	1.4 lbs / 650 g

## Multifunctional and wheelchair scales

	 <b>seca 644</b>	 <b>seca 684</b>	 <b>seca 676</b>	 <b>seca 664</b>	 <b>seca 656</b>	 <b>seca 674</b>
 <b>Page 82–89</b>	 <b>seca 644</b> Digital multifunctional handrail scale with wireless transmission.	 <b>seca 684</b> Digital multifunctional scale with stable handrail and high load bearing capacity.	 <b>seca 676</b> Digital wheelchair scale with handrail and wireless transmission.	 <b>seca 664</b> Digital wheelchair scale with wireless transmission.	 <b>seca 656</b> High capacity digital stretcher scale with wireless transmission.	 <b>seca 674</b> High capacity digital platform scale with transport castors.
<b>Technical data</b>	<b>Page 84</b>	<b>Page 85</b>	<b>Page 86</b>	<b>Page 87</b>	<b>Page 88</b>	<b>Page 89</b>
Capacity	800 lbs / 360 kg	800 lbs / 360 kg	800 lbs / 360 kg	800 lbs / 360 kg	800 lbs / 360 kg	800 lbs / 360 kg
Graduation	0.1 lbs / 50 g	0.1 lbs / 50 g	0.1 lbs / 50 g	0.1 lbs / 50 g	0.1 lbs / 50 g	0.1 lbs / 50 g
Dimensions (WxHxD)	25.2 x 45.3 x 26" 640 x 1,150 x 660 mm	35.8 x 43.3 x 41.9" 910 x 1,100 x 1,064 mm	36.2 x 44.1 x 45.3" 920 x 1,120 x 1,150 mm	43.4 x 35.9 x 45.3" 1,102 x 912 x 1,150 mm	35.2 x 3.4 x 65.2" 893 x 87 x 1,655 mm	35.6 x 2.8 x 41.9" 904 x 70 x 1,064 mm
Dimensions/platform (WxHxD)	23.6 x 2.2 x 23.6" 600 x 55 x 600 mm	31.5 x 2 x 33.1" 800 x 50 x 840 mm	31.5 x 2.2 x 38" 800 x 55 x 965 mm	31.5 x 2.2 x 38" 800 x 55 x 965 mm	31.5 x 2.2 x 57.7" 800 x 55 x 1,465 mm	31.5 x 2.2 x 38" 800 x 55 x 965 mm
Weight	55.9 lbs / 25.4 kg	131.2 lbs / 59.5 kg	83.8 lbs / 38 kg	73.6 lbs / 33.4 kg	101.9 lbs / 46.2 kg	59.5 lbs / 27 kg
Power supply	Power adapter, rechargeable batteries	Power adapter	Power adapter	Power adapter, rechargeable batteries	Power adapter	Power adapter
<b>Functions/Accessories</b>						
TARE/Pre-TARE	•	•	•	•	•	•
HOLD	•	•	•	•	•	•
Auto-HOLD	•	•	•	•	•	•
BMI	•	•	•	•	•	•
Auto-CLEAR	•	•	•	•	•	•
lbs/kg switch-over	•	•	•	•	•	•
Damping	•	•	•	•	•	•
RESET	•	•	•	•	•	•
Automatic switch-off	•	•	•	•	•	•
SEND/Auto-SEND	•	•	•	•	•	•
PRINT/Auto-PRINT	•	•	•	•	•	•
Transport castors	•	•	•	•	•	•
Ramp		1 x seca 470	2 x integrated	2 x integrated	2 x integrated	1 x seca 470
<b>Version</b>						
RS232 interface		seca 684 r (incl. dialysis interface cable)	seca 676 r (incl. dialysis interface cable)			
<b>Optional</b>						
Mechanical accessories	Measuring rod seca 223				Stand for cable remote display seca 472	Stand for cable remote display seca 472, additional ramp seca 470
PC interface cable		seca 451 (only for seca 684 r)	seca 451 (only for seca 676 r)			
<b>System compatible with</b>						
products of the seca 360° wireless system	•	•	•	•	•	•
EMR	•	•	•	•	•	•

## Accessories for multifunctional and wheelchair scales

	 <b>seca 223</b>	 <b>seca 472</b>	 <b>seca 470</b>	 <b>seca 451</b>
 <b>Page 84</b>	 <b>seca 223</b> Telescopic measuring rod for the seca 644 handrail scale.	 <b>seca 472</b> Stand for display elements of seca scales with cable remote displays.	 <b>seca 470</b> Drive-up ramp as accessory for seca 674.	 <b>seca 451</b> PC interface cable (female) for the multifunctional and wheelchair scale seca 684 r and seca 676 r.
<b>Technical data</b>	<b>Page 84</b>	<b>Page 89</b>	<b>Page 89</b>	<b>Page 85</b>
Measuring range	2–90" / 6–230 cm			
Graduation	1/8" / 1 mm			
Dimensions (WxHxD)	4.7 x 91.3 x 11.3" 120 x 2,320 x 286 mm	18.1 x 40.7 x 18.1" 460 x 1,035 x 460 mm	31.9 x 1.4 x 9.8" 810 x 35 x 250 mm	31.9 x 1.4 x 9.8" 810 x 35 x 250 mm
Cable length				43.3" / 1.1 m
Weight	2.1 lbs / 952 g	17.2 lbs / 7.8 kg	4.3 lbs / 2 kg	0.09 lbs / 40 g



## Chair scales

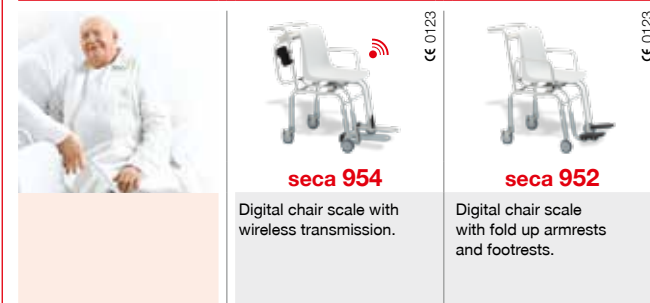

**seca 954**

Digital chair scale with wireless transmission.

**seca 952**

Digital chair scale with fold up armrests and footrests.

Page 90–91

Page 90

Page 91

Technical data	
Capacity	660 lbs / 300 kg
Graduation	0.1 lbs < 330 lbs > 0.2 lbs / 50 g < 150 kg > 100 g
Dimensions (WxHxD)	22.2 x 35.3 x 38.5" / 563 x 897 x 978 mm
Weight	54 lbs / 24.5 kg
Power supply	Power adapter, rechargeable batteries
Directive	MP/EMC
Functions	
TARE	•
Pre-TARE	•
HOLD	•
Auto-HOLD	•
BMI	•
lbs/kg switch-over	•
Damping	•
RESET	•
Automatic switch-off	•
SEND/Auto-SEND	•
PRINT/Auto-PRINT	•
RS232 compatible	•
System compatible with	
products of the seca 360° wireless system	•
EMR	•

## Bed and dialysis scale



**seca 984**

Digital bed and dialysis scale with integrated mechanical lifters and equipment trolley.

Page 92

Technical data	
Capacity	1,100 lbs / 500 kg
Graduation	0.2 lbs < 440 lbs > 0.5 lbs / 100 g < 200 kg > 200 g
Dimensions/cart (WxHxD)	20.5 x 36.5 x 22.1" / 520 x 927 x 562 mm
Dimensions/load cells (WxHxD)	12.9 x 5.9 x 8.3" / 328 x 150 x 212 mm
Weight	56.4 lbs / 25.6 kg (load cells + cart)
Power supply	Power adapter, rechargeable batteries
Directive	MP/EMC
Functions	
TARE/Pre-TARE	•
HOLD	•
BMI	•
Lower limit value	•
lbs/kg switch-over	•
Damping	•
Optional	
RS232 interface	seca 460

## Accessories for bed and dialysis scale



**seca 460**

RS232 interface for transmitting data to PC and/or printer for seca 984.

Page 93

Technical data	
Dimensions (WxHxD)	3.9 x 1 x 2.4" / 100 x 25 x 60 mm
Cable length	11.8 + 47.2" / 0.3 m + 1.2 m
Weight	0.3 lbs / 122 g

## Organ and diaper scale



**seca 856**

Organ and diaper scale with protected electronics for precise determination of net weight.

Page 94

Technical data	
Capacity	11 lbs / 5 kg
Graduation	0.05 oz < 6.6 lbs > 0.1 oz / 1 g < 3 kg > 2 g
Dimensions (WxHxD)	10.4 x 2.1 x 10.4" / 265 x 53 x 265 mm
Dimensions/scale platform (WxHxD)	9.3 x 0.2 x 6.7" / 235 x 5 x 170 mm
Weight	4.2 lbs / 1.9 kg
Power supply	Batteries
Directive	EMC
Functions	
TARA	•
Pre-TARA	•
HOLD	•
lbs/kg switch-over	•
Automatic switch-off	•

## Digital portion and diet scale



**seca 852**



Digital portion and diet scale with perfect fitting bowl for safe storage, finest graduation.

Page 95

Technical data	
Capacity	6.6 lbs / 3 kg
Graduation	0.05 oz / 1 g
Dimensions (WxHxD)	8.3 x 5.5 x 8.3" / 210 x 140 x 210 mm
Dimensions/scale platform (WxHxD)	5.5 x 2.1 x 5.5" / 140 x 53 x 140 mm
Weight	1.6 lbs / 710 g
Power supply	Batteries
Directive	EMC
Functions	
TARE	•
lbs/kg switch-over	•
Automatic switch-off	•





## Digital printers with wireless reception

		
	<b>seca 466</b>	<b>seca 465</b>
	Digital printer with wireless reception and analysis of measurements on thermal paper or labels.	Digital printer with wireless reception and analysis of measurements on thermal paper.
<b>Page 96–97</b>	<b>Page 96</b>	<b>Page 97</b>
<b>Technical data</b>		
Dimensions (WxHxD)	4.2 x 4.1 x 7.1" 106 x 105 x 180 mm	4.2 x 4.6 x 6.7" 106 x 116.5 x 170 mm
Weight	2.2 lbs / 1 kg	1.8 lbs / 800 g
Power supply	Power adapter seca 360° wireless technology	Power adapter seca 360° wireless technology
Data transmission	80 mm/sec	80 mm/sec
Print speed	48 mm	48 mm
Print width		
<b>Functions/Accessories</b>		
Print-out	Height, weight, BMI, resting or total energy expenditure or percentiles for children	Height, weight, BMI, resting or total energy expenditure or percentiles for children
Integrated automatic cutter	•	
<b>Optional</b>		
Thermal paper seca 485	5 or 50 rolls	5 or 50 rolls
Labels seca 486	1 or 24 rolls	
<b>System compatible with</b>		
products of the seca 360° wireless system	all scales and measuring instruments in the seca 360° wireless system	all scales and measuring instruments in the seca 360° wireless system
EMR	•	•
<b>Included with printer</b>		
SD smart card	•	•
Power adapter	•	•
SD card reader	•	•
1 roll of thermal paper	•	•
1 roll of labels	•	•



## Accessories for digital printers

		
	<b>seca 485</b>	<b>seca 486</b>
	Thermal paper rolls for seca 360° wireless printers seca 466 and seca 465.	Roll of labels for seca 360° wireless printer seca 466.
<b>Page 96</b>	<b>Page 96</b>	<b>Page 96</b>
<b>Technical data</b>		
Dimensions (WxHxD)	2.2 x 2.3 x 2.3" 57 x 59 x 59 mm	2.3 x 2.5 x 2.5" 58 x 64 x 64 mm
Weight	0.3 lbs / 140 g	0.3 lbs / 140 g
Packaging unit	5 or 50 rolls	1 or 24 rolls

## Software

		
	<b>seca analytics 115</b>	<b>seca emr flash 101</b>
	Medical PC software for diagnostic assistance.	software to connect seca 360° wireless products to Electronic Medical Record (EMR) Systems.
<b>Page 98–101</b>	<b>Page 98</b>	<b>Page 100</b>
<b>Technical data</b>		
Dimensions (WxHxD)	5.4 x 7.6 x 0.3" 137 x 192 x 7 mm	
Weight	0.2 lbs / 78 g	
<b>System requirements</b>		
Supported operating systems	Windows® 10, Windows® 8.1, Windows® 8, Windows® Server 2012 R2, Windows® Server 2012, Windows® 7 (SP1), Windows® Vista (SP1, SP2), Windows® Server 2008 R2 and Windows® Server 2008	Windows® 10, Windows® 8.1, Windows® 8, Windows® 7 (SP1) and Windows® Vista (SP1, SP2)
Processor	1.2 GHz or higher	
Memory	minimum 512 MB RAM	
Additional HW	DVD drive	
Ports	for usage in combination with seca medical devices USB port (2.0) or serial interface (RS232)	for usage in combination with seca medical devices USB port (2.0) or serial interface (RS232)
Display	1,024 x 768, High Colour (16-bit), 32-bit (recommended)	
<b>System compatible with</b>		
products of the seca 360° wireless system	all scales and measuring instruments in the seca 360° wireless system	all scales and measuring instruments in the seca 360° wireless system
EMR	•	•

## Accessories for software

		
	<b>seca 456</b>	<b>seca 456 wa</b>
	seca 360° wireless USB adapter for wireless data reception.	seca 360° wireless USB adapter for data reception and transmission to a Welch Allyn CVSM, Welch Allyn Connex® Spot Monitor or Integrated Wall System.
<b>Page 101</b>	<b>Page 101</b>	<b>Page 101</b>
<b>Technical data</b>		
Dimensions (WxHxD)	3.3 x 0.9 x 0.4" 85 x 23 x 10 mm	3.3 x 0.9 x 0.4" 85 x 23 x 10 mm
Weight	0.026 lbs / 12 g	0.026 lbs / 12 g
<b>System requirements</b>		
Supported operating systems	Windows® 10, Windows® 8.1, Windows® 8, Windows® Server 2012 R2, Windows® Server 2012, Windows® 7 (SP1), Windows® Vista (SP1, SP2), Windows® Server 2008 R2 and Windows® Server 2008	Windows® 8.1, Windows® 8, Windows® Server 2012 R2, Windows® Server 2012, Windows® 7 (SP1), Windows® Vista (SP1, SP2), Windows® Server 2008 R2 and Windows® Server 2008
Ports	for usage in combination with seca medical devices USB port (2.0)	for usage in combination with seca medical devices USB port (2.0)
<b>System compatible with</b>		
products of the seca 360° wireless system	all scales and measuring instruments in the seca 360° wireless system	all scales and measuring instruments in the seca 360° wireless system
EMR	•	•



## seca technical terms – a brief explanation.

### Measuring systems and scales:

<p><b>TARE function</b> Useful when any additional weight (e.g. diapers or blankets of babies/small children and also chairs or wheelchairs) is not to be included in the result. First, this additional weight is measured and then the display is reset to zero. The weight of this object is then disregarded at the next weighing.</p>	<p><b>Patient data input</b> Data such as gender, age and PAL (Physical Activity Level) can be entered via the input key on the multi-function touch display of the seca 284 dp. Together with the height and weight measurements, the data are wirelessly transmitted to the seca 360° wireless printer, where they are used to calculate the resting energy expenditure and total energy expenditure or percentiles for children and teenagers.</p>
<p><b>Pre-TARE function</b> When activated, a previously stored value is automatically deducted from the currently measured weight. For example, when caregiver and patient stand on the scales together and only the weight of the patient is to be shown.</p>	<p><b>CLEAR, Auto-CLEAR function</b> Old measurements or patient data can lead to incorrect calculations. Therefore, the CLEAR function deletes results from previously measured patients. It can be activated manually or automatically with Auto-CLEAR after five minutes.</p>
<p><b>BMIF – Breast-Milk-Intake-Function</b> The amount of milk taken by a baby when being breastfed can be ascertained with the aid of the Breast-Milk-Intake-Function. At the touch of a button, the weight of the baby determined before feeding is stored and then deducted from the weight determined after feeding (difference function).</p>	<p><b>Limit value function</b> For effective monitoring of patients, one can preset a weight limit and an alarm rings if this is exceeded.</p>
<p><b>Mother/child-function</b> This function was developed to enable the weighing of children in the arms of their parents. When the mother/child-function is activated, the previously stored weight of the adult is deducted from the currently determined value. The display then shows only the weight of the child, with an accuracy of down to 50 g.</p>	<p><b>Weighing range switch-over</b> seca scales with a multi-range function let you quickly switch manually from one range to another. From a fine graduation at low capacity in scale range 1 to maximum capacity in scale range 2.</p>
<p><b>HOLD, Auto-HOLD</b> Once the weight has been saved with a press of the HOLD key, it remains in the display after the patient has left the scale. This function lets the doctor or nurse care for the patient first and then record the weight. When the Auto-HOLD function is activated, the HOLD function is automatically triggered as soon as the weight has stabilized.</p>	<p><b>Damping function</b> The damping function makes it possible to determine the precise weight in spite of disturbances during the weighing process, e.g. caused by the patient moving. The degree of damping can be adjusted as required before weighing a patient: the stronger the damping, the less sensitively the scales react to the movements during the weighing process.</p>
<p><b>Step-off function</b> This is the function which makes it possible to weigh oneself without first switching the scales on. Simply stand on the platform briefly, wait for the "Step-off" instruction, then stand comfortably next to the scale and read off the values. Ideal, especially for pregnant women and people of larger girth.</p>	<p><b>RESET function</b> The RESET function restores the factory settings.</p>
<p><b>BMI function</b> The Body Mass Index correlates height and weight to one another. A tolerance zone considered to be ideal from a health point of view is between 18.5 and 24.9. If the value is higher or lower, medical advice should be obtained.</p>	<p><b>SEND, Auto-SEND function</b> At the press of a button, all measurements and input data are wirelessly transmitted to receive-ready devices such as a scale with a corresponding BMI function, a wireless printer, a PC with the software seca emr flash 101 or software seca analytics 115. When the Auto-SEND function is activated, the SEND function is automatically triggered when the weight on the scale has stabilized or height measurements have been confirmed.</p>
<p><b>BFR</b> The Body Fat Rate compares the patient's percentage of fat with an ideal value. Body height and weight are the basis of calculation; extra consideration is given to gender.</p>	<p><b>PRINT-, Auto-PRINT-function</b> With the PRINT function the measurements and input data are wirelessly transmitted to a seca 360° wireless printer, where they are processed and printed. When the Auto-PRINT function is activated, the PRINT function is automatically triggered when the weight on the scale has stabilized or height measurements have been confirmed.</p>

### The seca mBCA:

<p><b>mBCA</b> Medical Body Composition Analyzer: a device that provides a medically precise measurement of a person's body composition.</p>	<p><b>REE</b> The amount of energy that the body needs per day of complete rest, at room temperature and with an empty stomach, in order to keep the bodily functions working.</p>
<p><b>BIA</b> Bioelectrical Impedance Analysis: a method of analyzing body composition. This involves measuring the resistance of the body and its parts to a weak alternating electrical current.</p>	<p><b>TEE</b> Total Energy Expenditure: the total energy expenditure consists of the resting energy expenditure and the energy expended for everything the body does (muscle work, mental work, other body exertions).</p>
<p><b>FM</b> Fat Mass: the fat mass defines the amount of body fat in kg as an absolute mass and in % as the relative proportion of the body weight.</p>	<p><b>HYD</b> Hydration: the ratio of extracellular water to intracellular water.</p>
<p><b>FFM</b> Fat-Free Mass: the total body weight minus the fat mass.</p>	<p><b>Impedance (Z), Phase angle (φ), Resistance (R), Reactance (Xc)</b> These represent the raw data from the bioelectrical impedance analysis that can be used for medical studies. This includes the impedance, the phase angle and the two impedances, resistance and reactance.</p>
<p><b>FMI</b> Fat Mass Index: this index measures the proportion of body fat based on the height, weight and fat mass.</p>	<p><b>BMI</b> Body Mass Index: the unit of measurement for the analysis of body weight in relation to a person's height, calculated using the formula (weight in kg/height in m)<sup>2</sup>.</p>
<p><b>FFMI</b> Fat-Free Mass Index: this is a measurement of the muscle definition of a human body. The measurement is based on the body height, weight and fat-free mass.</p>	<p><b>BIVA</b> Bioelectrical Impedance Vector Analysis: the way in which the BIVA is presented enables analysis of hydration and cell mass.</p>
<p><b>SMM</b> Skeletal Muscle Mass: this includes all the muscles that are attached to the skeleton or – by extension – used to move the body.</p>	<p><b>BCC</b> Body Composition Chart: the Body Composition Chart developed by seca shows the measurement points of the fat mass index in a coordinate system and helps to determine body composition.</p>
<p><b>TBW</b> Total Body Water: the sum of the fluids outside and inside the cells of the body, not including the substances dissolved therein.</p>	<p><b>EMR</b> Electronic Medical Record: these are information systems that are used in hospitals to record and present patient information.</p>
<p><b>ECW</b> Extracellular Water: all fluids found outside the cells in the human body.</p>	<p><b>HL7, GDT</b> These are recognized data formats needed by most EMR systems to process patient data.</p>
<p><b>ICW</b> Intracellular Water: all fluids found inside the cells in the human body.</p>	



Products bearing this symbol fulfill the applicable requirements of the following directive:

- 93/42/EEC on medical devices



The professionalism of seca is also officially recognized. The notified body for medical devices responsible for seca confirms with the certificate that seca consistently complies with the strict legal requirements as a manufacturer of medical devices. The quality assurance system at seca includes the areas of Design and Development, Production, Sales and Service of medical scales, height measuring instruments, software and measurement systems for the assessment of health status and nutritional condition. In addition, seca is also authorized to perform the EC calibration by the manufacturer of medical weighing instruments.



seca contributes to environmental protection. We are anxious to preserve our natural resources. This is why we strive to save packaging material where practical. And what is left over can be conveniently disposed of locally via Germany's Dual System recycling programme.

# Biomedical Engineering Technology –

seca values your expertise.

Clinical Engineers are a critical component of patient care and improving medical outcomes. The healthcare industry is critically dependant on your expertise of sophisticated medical diagnostics and the development of therapeutic equipment.

seca is committed to providing you with enhanced education and support in the delivery and advancement of patient care. Join our Alliance program and receive the latest updates on device integration, network software issues and schedule your online or in person training. Our online Biomed resources make it convenient to access service manuals, calibration instructions, or troubleshoot a potential product issue.

Biomed Hotline:  
**1-800-987-7322**



## seca | green

### Our Employees

The continuous reduction of energy and raw materials are not limited to individual seca products and production facilities. Every single employee is involved.

### Our Service

Our seca service is also service for the environment. Ranging from our fleet of vehicles and packaging of replacement devices, all the way to individual replacement parts.

### Our Products

Economical with raw materials, resources and energy.

### Our Suppliers

Besides complying with RoHS and REACH regulations, seca is concerned with improving ecological conditions and optimizing the working environment.

### Our Locations

Environmental protection begins at seca not with the finished product but with its manufacture. From the factory to the administration building, from Hamburg to China.



## Our red is 100% green.

At seca when we say “Nothing weighs more than life,” we are referring to more than our measuring instruments and scales. Working toward good health takes place not only in doctors’ practices, hospitals and nursing homes, but everywhere on this planet.

Every effort that keeps you healthy is worth making. We work for your health with the same dedication and energy that has made us the world’s market leader in medical measuring and weighing.





the brand of the medical field.

Since 1840 seca has been paving the way for measuring and weighing. Every day we find new solutions that provide doctors, nurses, and other health care professionals with effective support in their daily routines.

# Experience

# Quality



- seca north america
- seca mexico
- seca brasil
- seca américa latina
- seca deutschland
- seca france
- seca united kingdom
- seca schweiz
- seca austria
- seca polska
- seca suomi
- seca zhong guo
- seca nihon
- seca middle east
- seca asia pacific

# Progress

# International outlook

## Experience is valuable if it gives birth to understanding.

- The same process since 1840: develop – question – improve
- Continuous development thanks to our own production sites
- Many years of dedication and expertise in the fight against widespread disease such as chronic obesity

## Innovation means thinking outside the box.

- seca products are an integral part of the process of diagnosis and therapy
- More than just products: system solutions for simple integration of data into any EMR system
- Intelligent details make working with patients easier
- The prerequisite for innovation: an in-house development department
- Multi-award winning design



## High quality proves itself over time.

- A secure investment: long service life
- Precise measurement under difficult conditions
- Global quality management to local national standards
- All-around service before and after purchase
- Exclusive authorization from governing bodies to certify our own products

## If you know the world, you know how the world works.

- The world market leader in medical measuring and weighing
- Products exported to more than 110 countries
- Knowledge of markets and routine medical work in different countries, thanks to local subsidiaries and partners
- Used everywhere: from the most advanced clinics to development aids



## seca and art

See the world through  
our eyes.

**P**ush the boundaries, reinvent the world and never be satisfied. That's the way artists have thought since art began and the way we have thought since seca was founded. That was and is precisely why art has grown into an important source of inspiration over our 177 years of existence. It brings up new questions, leads to new perspectives, and expands horizons – for our products too. We would like to have you participate in this process. In 2009, for instance, media artist Christina Lissmann created an image portfolio for seca that shows our products in a limitless fantasy world. In the current seca art project the renowned photographic artists, Barbara Metz and Eve Racine, are dealing with balance in the body. Without it, the body falls ill – balance is recovered in the end with the aid of seca. The human body is illustrated in an abstract and mechanical yet also playful and lively way. Welcome to the inspiring, limitless world of art. Welcome to seca.